



# learning environments

furniture & equipment

# 2023

## FROM US TO YOU

At School Specialty, we're committed to doing all we can to ensure every student in every school has what they need to succeed. That's why our dedicated team of experts works hard to bring together a selection of exciting and effective solutions in our annual Learning Environments catalog.

Be sure to share this catalog with others who might benefit from the ideas and inspiration inside and remember you can shop our full assortment any time at **Select.SchoolSpecialty.com**

Before you pass along this catalog, be sure to check out some exciting new offerings.

Find new products on pp. 2-3. Discover the advantages of working with School Specialty on p.6. Learn out about our expert design service, Projects by Design® on p.4. Get tips to maximize your budget on p.7. And find out how our Innovate360™ program can help you develop a custom selection of furniture and equipment to serve as your district's standards p.5.

You can also find these and even more solutions and inspiration online. Be sure to go to **Select.SchoolSpecialty.com** to see how we put the "more" in our promise to transform more than classrooms.

Sincerely,

 School Specialty®

SCAN THIS CODE  
TO SEE OUR NEW  
2023 COLLECTION  
OF CLASSROOM  
SELECT® PRODUCTS







## As a manufacturer, we offer quality, affordability, & expertise.

Because we manufacture our furniture and have investments in the supply chain, we offer advantages in pricing and lead times. Because our name is on all we make, we hold ourselves to the highest quality standards. We source the best materials globally and assemble it all here in the USA. And because your students are our first priority, our education experts build purpose and best practice into everything we offer.





# new ways to learn

## new ways to engage

Discover innovative new products from Classroom Select® & Childcraft®.  
We source the best materials globally & assemble it all here in the USA.

We're always adding new products, so be sure to visit  
**Select.SchoolSpecialty.com/new**

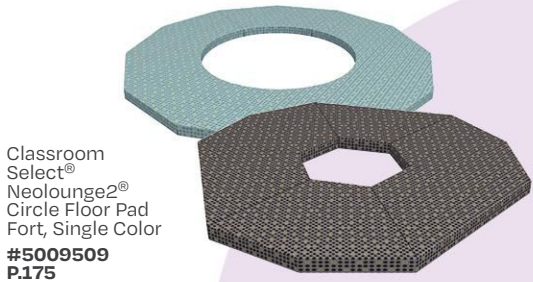

Classroom Select®  
Neolounge2®  
Circle Floor Pad  
Fort, Single Color  
**#5009509 P.175**

Classroom Select®  
Neolounge2® Polygon Floor  
Pad Fort, Single Color  
**#5009507 P.175**



Classroom Select®  
Neolounge2®  
Circle Floor Pad Fort,  
Dual Color  
**#5009513 P.175**

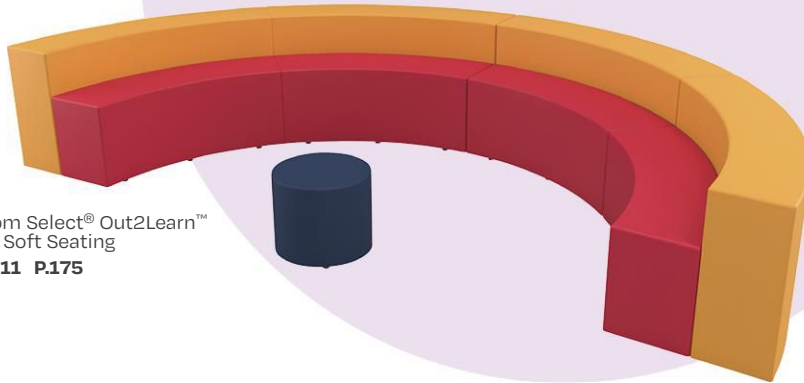

Classroom Select® Out2Learn™  
Outdoor Soft Seating  
**#5009511 P.175**

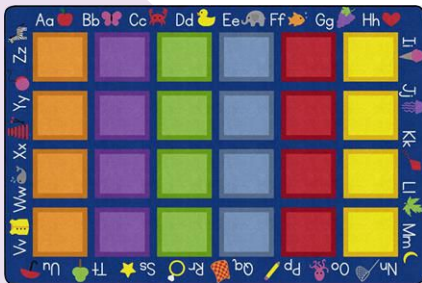

Childcraft® Colorful Squares Carpet  
**#2105269 P.363**

Childcraft® Mobile Flat Tray & Folder  
Cubby Unit with Primary Color Trays  
**#2092041 P.322**







Classroom Select® Inspo®  
Stacking Desk  
**#5009544 P.35**



Screen not included with stand. Illustration purposes only.

Classroom Select® Media Wall/Cart  
**#2104604 P.120**



Classroom Select® Advocate Series® E-Sports Desk  
**#5009528 P.78**



Classroom Select® Double-Sided Markerboard  
**#2104603 P.159**



Classroom Select® Drafting Desk  
**#674514 P.54**



Classroom Select® NeoClass® Podium Teachers Desk  
**#5009519 P.211**

Classroom Select® Convertible Bench Table  
**#1433640 P.185**



Classroom Select® Advocate Series® Project Table  
**#5009902 P.77**





projects **by design**®

## A partner every step of the way.

Projects By Design® is our turnkey service from complimentary design through installation and beyond. We can be your single source for products, design, and project management resulting in one P.O. for your entire project. Our team of Learning Environment Specialists and in-house Interior Designers can work with you to create comprehensive ecosystems that equip and inspire every student, from birth to grade 12. We've done this for thousands of school building projects over the past two decades and we'd love to do all of this for you.



### Discover

First, we partner with you to roadmap your school's construction, renovation, or modernization programs. From auditing your current space through helping gain alignment on budget and vision.



### Design

Next, we bring your product selections to life. We show you 2D and 3D color renderings, provide final price proposals detailed room-by-room, and work together to refine selections until stakeholder consensus is achieved.



### Deliver

To ensure on-time and on-budget delivery and installation, the School Specialty® team will supervise the entire post-award process, manage all logistical arrangements, and ensure a flawless installation.



### Develop

We offer a variety of professional development courses designed to help you get the most out of your learning environments. They're ready when you are – take as much time as you need, before or after installation.



For more information about School Specialty's Projects by Design service, contact your local School Specialty Representative or visit us here







## School Specialty. Innovate 360™

### The 360° support you need to create dynamic learning spaces

Do you have a new building project, existing classrooms in need of renewal, or the need to purchase instructionally appropriate furniture to supplement your current environments?

Do you want to create dynamic, engaging environments that enable today's varied educational programs while also allowing for future evolution?

Do you want an expert, local partner with you every step of the way? We will collaborate with you to help create your district's furniture and equipment standards – all designed to meet your unique needs.

Our program offers:

- High-quality furnishings designed specifically for the needs of education and selected to support your district's instructional practices
- Organized and presented in a way that makes it easy to find what you need
- A friction-free procurement process since every selection is already district-approved

**Let us customize the program you want to fit your needs. Contact your sales representative today.**



CLASSROOM  
SELECT

CHILDCRAFT



# Why choose between a large national company or a small local partner?

## Get both.

NATIONAL STRENGTH

LOCAL PARTNERSHIP

More depth & breadth of furniture, supplies, & curriculum than anywhere else

**EXTENSIVE  
PRODUCT  
OFFERING**

Find exactly the right products for your objectives & needs

100's of people focused solely on schools -Subject Matter Experts, Sales Partners, customer care, logistics & more

**EDUCATIONAL  
EXPERTISE**

Your dedicated senior sales rep & local team will understand your district and bring you the right experts

From interior design through installation, our Projects by Design® service provides end-to-end support

**DESIGN &  
PROJECT  
MANAGEMENT**

You will have a local design and installation team to meet with you face-to-face to understand your specific needs

As education experts, purpose & best practices are built into all our proprietary furniture

**MANUFACTURER=  
AFFORDABLE +  
QUALITY**

Since we control the manufacturing, we can give you advantages in pricing & lead times

Enjoy competitively negotiated prices with no need to bid & the ease of one PO

**PURCHASING  
COOPERATIVE  
ADVANTAGES**

We participate with many national & local co-ops as well as many state contracts

You can shop in our catalogs, buy online, or get direct support from a dedicated sales representative

**CONVENIENT  
SHOPPING  
CHOICES**

When you're ready to order, we make it easy. We're already compliant with your district requirements

Contact your local sales representative to learn more or get started.



# SHOP ONLINE.

More products.

More savings.

More control.

Our enhanced ecommerce experience is built to save you serious money and precious time.

- **See your discounted pricing automatically** whenever you sign in.
- **Control budgets with approval workflows.** No order gets placed without your approval.
- **Manage and track orders like never before.** Access invoices, check order status, and see order history.
- **Avoid mismatched POs.** Online orders are more accurate – items, pricing, and shipping charges are accurate online.
- **Make purchasing more seamless.** Our website integrates with most procurement systems: Skyward, Infinite Visions, Munis, PowerSchool, Peoplesoft, and more.

**GO TO [Select.SchoolSpecialty.com](https://Select.SchoolSpecialty.com) NOW**



# 3 WAYS TO ORDER



## ONLINE

Select.SchoolSpecialty.com lets you shop 24/7 with the ability to see your best prices when you login



## PHONE

1-888-388-3224 M-F 7am to 6 pm CST  
International: 1-419-589-1425 M-F 7am to 4pm CST



## EMAIL

Contiguous 48 states: orders@schoolspecialty.com  
HI, AK & International:  
internationalorders@schoolspecialty.com

For details about Shipping and Handling, Warranties, Return Policy, and more, visit [customer.care.schoolspecialty.com/home](http://customer.care.schoolspecialty.com/home)

## TABLE OF CONTENTS

Classroom .....	9-82
Art .....	83-91
Music Room.....	92-95
Science.....	96-102
Makerspace.....	103-111
Education Technology.....	112-146
Presentation .....	147-165
Common Area-Media.....	166-184
Cafeteria & Food Court.....	185-200
Portable Chairs and Tables.....	201-209
Office.....	210-245
Storage & Shelving.....	246-265
Facility Furnishings .....	266-271
Safety & Security .....	272-284
Outdoor & Playground.....	285-301
Special Needs.....	302-313
Early Childhood .....	314-378
Index.....	379-381

## PRODUCT SAFETY INFORMATION

Watch for these warnings on some of the products included in this catalog:

CHOKING HAZARD (1). Not for under 3yrs.

**WARNING: CHOKING HAZARD** – Small Parts. Not for children under 3 yrs.

CHOKING HAZARD (2). Not for under 8yrs.

**WARNING: CHOKING HAZARD** – Children under 8 yrs. can choke or suffocate on uninflated or broken balloons. Adult supervision required. Keep uninflated balloons away from children. Discard broken balloons at once.

CHOKING HAZARD (3). Not for under 3yrs.

**WARNING: CHOKING HAZARD** – This toy is a small ball. Not for children under 3 yrs.

CHOKING HAZARD (4). Not for under 3yrs.

**WARNING: CHOKING HAZARD** – Toy contains a small ball. Not for children under 3 yrs.

CHOKING HAZARD (5). Not for under 3yrs.

**WARNING: CHOKING HAZARD** – This toy is a marble. Not for children under 3 yrs.

CHOKING HAZARD (6). Not for under 3yrs.

**WARNING: CHOKING HAZARD** – Toy contains a marble. Not for children under 3 yrs.

SUFFOCATION HAZARD. Not for under 2 yrs.

**WARNING: SUFFOCATION HAZARD** – Long cord. Not for children under 2 yrs.

## SAFETY DATA SHEETS

Safety Data Sheets (SDS) provide product safety information covering safe handling, first aid measures, waste disposal, and methods of extinguishing fires, if flammable. Some products do not typically contain toxic materials and therefore do not require SDS.

Access SDS by item at [Select.SchoolSpecialty.com](http://Select.SchoolSpecialty.com) by clicking the VIEW/SDS link on the product detail page, using our SDS portal at [Select.SchoolSpecialty.com/sds](http://Select.SchoolSpecialty.com/sds), or contact our Customer Care department at 888-388-3224.

## CLASSROOM SELECT FURNITURE & EQUIPMENT

CLASSROOM SELECT

At Classroom Select®, everything we offer in our comprehensive line of furniture solutions — from contemporary to traditional, from seating to storage — is designed to help you create future-ready spaces.

Take a look at our innovative solutions. Consult with our extensive team of experts. And together we can create learning environments that help the next generation of learners become the next generation of leaders.

For more details, visit [Select.SchoolSpecialty.com/classroom-select](http://Select.SchoolSpecialty.com/classroom-select)

## AVAILABLE THROUGH CO-OPS AND ON CONTRACTS

School Specialty holds contracts with the largest purchasing cooperatives and state education agencies across the U.S. With this purchasing power, you get competitively-bid prices and buying advantages. For more details, visit [Select.SchoolSpecialty.com/purchasing-cooperatives](http://Select.SchoolSpecialty.com/purchasing-cooperatives)

**BEST PRICES**







# classroom

CLASSROOM  
**SELECT** 



PRODUCT CERTIFIED  
FOR LOW CHEMICAL  
EMISSIONS:  
UL.COM/GG  
UL-2918



 PLEASE  
SPECIFY  
COLOR  
CHOICE

Refer to pages 60-61 for  
color options.



projects by design™

## Classroom Select® NeoRok® Height Adjustable Stool

Features your choice of three 360 degree swivel seat options, NeoRok® rubber seat, soft seat, or the premium soft seat plus; all providing optimal comfort. The rounded-base design allows high-energy students to focus as they rock and tilt in all directions. The sturdy, yet lightweight, polypropylene frame encourages proper posture and makes mobility and storage simple. Easy-press handle located under the seat top allows for a simple height adjustment. Assembled.

**2 Week Quickship** available in your choice of Cardinal (Red), Tangerine, Lime, Marine (Royal Blue), Imperial (Navy Blue), or Ebony (Black).

Item #	Seat Height	Seat and Back Color	List Price
<b>NeoRok® Rubber Seat</b>			
<b>A</b> 5-5000845-670	14-1/2 - 20-1/2 in	Specify	\$172.95
<b>NeoRok® Soft Seat Stool</b>			
<b>B</b> 5-5000846-670	15-1/2 - 21-1/2 in	Specify	\$206.95
<b>NeoRok® Soft Seat Plus Stool</b>			
<b>C</b> 5-5000847-670	15-1/2 - 21-1/2 in	Specify	\$239.95



Rubber Seat

Soft Seat

Soft Seat Plus

**24 HRS** **48 HRS** **1 OR 2 WEEKS**

**QUICKSHIP**  
Items ship within 24 hrs, 48 hrs, 1 or 2 weeks as indicated  
when the factory distribution center receives the order.

Items ship  or 

See Shipping & Handling terms for details.



PRODUCT CERTIFIED FOR LOW CHEMICAL EMISSIONS: UL.COM/MSG UL 2818



Refer to pages 60-61 for color options.



**Classroom Select® NeoRok® Stool**

The ability to move in an environment is proven to enhance learning, concentration, and attentiveness. With a unique rounded base design, this motion seating solution allows students to rock and tilt in all directions. The lightweight polypropylene stool is easy to transport and is the perfect fit for your interactive classroom. Assembled.

**Quickship available in your choice of Cardinal (Red), Tangerine, Lime, Marine (Royal Blue), Imperial (Navy Blue) or Ebony (Black).**

Item #	Seat Height	Seat and Back Color	List Price
5-1546367-670	20-1/2 in	Specify	\$112.95
5-1546366-670	18-1/2 in	Specify	\$106.95
5-1496633-670	15-1/2 in	Specify	\$99.95
5-1496631-670	12-1/2 in	Specify	\$92.95

**24-hr Quickship** available for items 1546366 and 1496633 with Marine (Royal Blue) frame color in quantities up to 45 each. Applies to orders containing 24 hour quick ship items only.

**Classroom Select® NeoRok® Soft Seat Stool**

This stool has motion seating! The rounded base frame allows high-energy students to focus as they rock and tilt in all directions. The easy to clean vinyl-covered polyurethane padded seat keeps students comfortable while encouraging proper posture and strengthening core muscles. The polypropylene frame is lightweight and makes mobility and storage simple. Assembled. **Quickship available in your choice of Cardinal (Red), Tangerine, Lime, Marine (Royal Blue), Imperial (Navy Blue) or Ebony (Black).**

Item #	Seat Height	Seat and Back Color	List Price
5-1597922-670	21-1/2 in	Specify	\$166.95
5-1597921-670	19-1/2 in	Specify	\$152.95
5-1597920-670	16-1/2 in	Specify	\$139.95
5-1597919-670	13-1/2 in	Specify	\$126.95



**Classroom Select® NeoRok® Soft Seat Plus Stool**

This stool features a premium soft seat, providing optimal comfort, while the rounded base design allows high energy students to focus as they rock and tilt in all directions. The sturdy, vibrant colored polypropylene frame is lightweight, encourages proper posture, and makes mobility and storage simple. Assembled. **Quickship available in your choice of Cardinal (Red), Tangerine, Lime, Marine (Royal Blue), Imperial (Navy Blue) or Ebony (Black).**

Item #	Seat Height	Seat and Back Color	List Price
5-1597926-670	21-1/2 in	Specify	\$206.95
5-1597925-670	19-1/2 in	Specify	\$192.95
5-1597924-670	16-1/2 in	Specify	\$179.95
5-1597923-670	13-1/2 in	Specify	\$166.95

**Classroom Select® NeoRok® NoRok Stool**

Classroom Select® NeoRok® NoRok Stool is a great non-rocking stool option for your classroom. The unique, non-rounded base design offers students a sturdy non-motion option. Available in your choice of three unique and comfortable seat options: rubber seat, soft seat, or the premium soft seat plus. This stool offers vibrant, fresh colors and is the perfect solution for learners of all ages. NeoRok® NoRok stools are ergonomically designed, lightweight, easily transported, and Greenguard Gold Certified. Assembled.

Item #	Seat Height	Seat and Back Color	List Price
<b>NeoRok® NoRok Rubber Seat Stool</b>			
5-5004153-670	20 in	Specify	\$139.95
5-5004154-670	18 in	Specify	\$132.95
5-5004155-670	15 in	Specify	\$126.95
5-5004156-670	12 in	Specify	\$119.95
<b>NeoRok® NoRok Soft Seat Stool</b>			
5-5004691-670	20 in	Specify	\$172.95
5-5004692-670	18 in	Specify	\$166.95
5-5004693-670	15 in	Specify	\$159.95
5-5004694-670	12 in	Specify	\$152.95
<b>NeoRok® NoRok Soft Seat Plus Stool</b>			
5-5004695-670	20 in	Specify	\$206.95
5-5004696-670	18 in	Specify	\$199.95
5-5004697-670	15 in	Specify	\$192.95
5-5004698-670	12 in	Specify	\$186.95





**CLASSROOM  
SELECT** 



PRODUCT CERTIFIED  
FOR LOW CHEMICAL  
EMISSIONS:  
UL.COM/SGG  
UL 2818



**PLEASE  
SPECIFY  
COLOR  
CHOICE**

Refer to pages 60-61  
for color options.

**Classroom Select® NeoRyde® Stool**

Expanding the capabilities of the popular NeoRok® Height Adjustable movement stool, the NeoRyde® features an integrated surface, perfect for note taking or use with up to a 14" laptop. The 9" of leg space between the seat and table surface is ideal for any age group. With its sleek modern shape featuring beveled corners, integrated hand grip, and height adjustable seat from 14-1/2" to 20-1/2" which swivels 360 degrees, the NeoRyde® was designed with comfort in mind. Select tablet arm color and stool color separately. Assembled.

Item #	Seat Height	Frame Color	Tablet Arm Color	List Price
5-5002717-670	14-1/2" - 20-1/2" in	Specify	Specify	\$227.95



**Classroom Select® NeoSync®**

The Classroom Select® NeoSync® transforms any room into an effective learning environment for all ages. Features beveled edges on the seat and top for premium comfort. Includes a pencil groove and stopper, integrated hand hold in the seat, and a hand grip in the neck for easy mobility. The 14-1/8" W x 13" D surface is the perfect fit for a standard size note pad or a 14" laptop or tablet. The 9" between the seat and writing surface provides ideal leg space for all ages. Add the NeoSync® storage cart to easily stack, store, and move from room to room. Cart is made from 16-gauge titanium powder coat steel and can hold up to 27 units. Assembled.

Item #	Frame Color	List Price
5-5002718-670	Specify	\$52.95
Item #	Description	List Price
6-2024419-670	NeoSync Storage Cart	\$297.95

**Classroom Select® NeoStak® Stool**

The NeoStak® is a fun addition to any classroom. Students and teachers alike will love this flexible seating option offering quick classroom transitions. The super soft cushion top provides students with optimal comfort. The conveniently placed hand holds allow students to move, stack or even turn over the stool, to be used as a storage compartment. The NeoStak® is constructed of durable, lightweight polypropylene, and is offered in two size options accommodating Kindergarten through 5th Grade. Available in 11 fun and exciting colors. Easily wipes clean with cloth and soapy water. Assembled.



Item #	Seat Height	Frame Color	List Price
5-5004129-670	15 in	Specify	\$169.95
5-5004689-670	12 in	Specify	\$156.95



PRODUCT CERTIFIED FOR LOW CHEMICAL EMISSIONS: UL.COM/SGG UL 2818



Refer to pages 60-61 for color options.

See pages 171-172 for the full NeoLounge® assortment



Round Rocking Base



**Classroom Select® NeoLounge® Round Rocker**

Create flexible and collaborative spaces for teachers and students with the NeoLounge® Rocker Ottoman. This ottoman is a great choice for students who need a little movement to focus. It features a non-skid round rocking base to protect floors and offers extra comfort to students on our high-quality foam. Choose from our expanded line of fabric colors and prints. Mix and match to create spaces for common areas, media centers, and even hallways. Customize by choosing one color or two colors for sides and top.

Description	Product Dimensions	One Color			Two Color			List Price
		Item #	Color	Item #	Top Color	Side Color		
Rocker Ottoman	18 W x 18 D x 20 H in	6-5004685-670	Specify	\$416.95	6-5004686-670	Specify	Specify	\$419.95
Rocker Ottoman	18 W x 18 D x 18 H in	6-5004683-670	Specify	\$398.95	6-5004684-670	Specify	Specify	\$402.95
Rocker Ottoman	18 W x 18 D x 15 H in	6-5004681-670	Specify	\$347.95	6-5004682-670	Specify	Specify	\$350.95
Rocker Ottoman	18 W x 18 D x 12 H in	6-5004679-670	Specify	\$323.95	6-5004680-670	Specify	Specify	\$327.95

**Classroom Select® Zoom Stack® Stool**

The Classroom Select® Zoom Stack® Stool broadens the possibility for independent and collaborative classroom engagement. Ideal for classrooms, atriums, libraries, media centers, and even hallways! Transition your classroom as many times as you need with this simple easy Zoom Stack® stool. Comfortable and versatile, the Zoom Stack® stool is offered as a single non-motion or motion stool and as a triple stack non-motion or motion stool set. The non-motion stool provides students a floor seating option encouraging posture and focus. The motion stool offers movement encouraging both physical and emotional well-being and also improves focus. One Zoom Stack® stool measures 17" diameter and is 7-1/2" high. Three Zoom Stack® stools measure 17" diameter and is 19" high. Attach stools with easy twist locking mechanism. Assembled.



Non-Motion Three Stack Stool



Single Non-Motion Stool



Single Motion Stool

Item #	Seat Height	Frame Color	List Price
<b>Non-Motion Stool</b>			
5-5004732-670	7-1/2 in	Specify	\$146.95
<b>Motion Stool</b>			
5-5004699-670	7-1/2 in	Specify	\$132.95
<b>Non-Motion Three Stack Stool</b>			
5-5004733-670	19 in	Specify	\$252.95
<b>Motion Three Stack Stool</b>			
5-5004734-670	19 in	Specify	\$239.95



Refer to pages 60-61 for color options.



PRODUCT CERTIFIED FOR LOW CHEMICAL EMISSIONS: UL.COM/IGG UL 2818



### Classroom Select® Kurve® Rocker

This sleek modern design features a subtle grid pattern and textured surface with perforated holes to enhance airflow. The curved base provides a gentle, smooth rocking motion for increased focus without distraction. Includes three hand hold options for easy carrying. Constructed of durable lightweight polypropylene, the shape and size offer a perfect fit for any pre-k through third grade setting. Assembled.

Item #	Product Dimensions	List Price
5-5002719-670	18 W x 17 D x 24-1/2 H in	\$41.95



Featuring the smooth back design

### Classroom Select® NeoClass® NeoLounge® Smooth Back Chair

The NeoLounge® is a full size shell with a seat 6" high, which is a perfect alternative to sitting on the floor. This height provides interactive collaborative learning that is fun and creative. A smooth back and subtle pattern create a contemporary look. Easy to clean. The lightweight design also makes these easy to move around the room as needed. Assembled.

Item #	Seat Height	Seat And Back Color	Frame Color	List Price
5-1597917-670	6 in	Specify	Chrome	\$91.95
5-1598667-670	6 in	Specify	Black	\$84.95

### Classroom Select® Inspo® Four Leg Chair with Fixed Arms

It's our most versatile classroom chair offering yet, now with an added fixed armrest! The chair is meant to meet the needs of any classroom environment offering comfort, ease of movement, updated design, and ergonomics. The waterfall seat edge, contoured back, and armrests bring ergonomic comfort, while opening at the top provide easy portability. Hidden hardware adds simplicity and elegance to the design. The 18" A+ provides a wider, more accommodating seat size. The sleek 3/4" round tube frame in 16-gauge steel is reinforced with an inner 9/16" 17-gauge, steel tube that offers strength, durability, and stability while still looking modern and pleasing to the eye. Available standard in a titanium powder coat frame and the chair shell is available in an array of polypropylene colors. Available in your choice of nylon, steel, felt, or rubber glides. Assembled.

Item #	Product Dimensions	Seat Height	Seat And Back Color	Frame Color	Glide/Caster Type	List Price
6-5008635-670	20W x 20D x 33-1/4H in	18.5 in A+	Specify	Titanium	Specify	\$139.95







PRODUCT CERTIFIED FOR LOW CHEMICAL EMISSIONS: UL/COMFES UL 2818



Refer to pages 60-61 for color options.



**Classroom Select® NeoMove® Smooth Back Elliptical Four Leg Movement Chair**

The ability to move in an environment is proven to enhance focus, concentration, and attentiveness. Bonded rubber shock mounts allow free mobility, providing optimum controlled motion. With the most innovative design, comfort and durability, this chair is your solution to student movement. The smooth, sculptured shell design creates a contemporary look while enhancing ease of cleaning. Sleek shell secures to a sturdy 4-leg 3/4" x 1-3/8" elliptical 14-gauge steel frame available in chrome, black powdercoat, or titanium powdercoat. Offered in 18" A+ and 20" A+ version with wider, more accommodating seating. The waterfall seat edge and contoured back bring ergonomic comfort, while openings at the top and bottom of the shell boost airflow and provide easy portability. Assembled.

Item #	Seat Height	Seat and Back Color	Frame Color	Glide/Caster Type	List Price
6-1507750-670	20 in A+	Specify	Chrome	Specify	\$272.95
6-1507751-670	20 in A+	Specify	Specify	Specify	\$266.95
6-1507752-670	18 in A+	Specify	Chrome	Specify	\$266.95
6-1507753-670	18 in A+	Specify	Specify	Specify	\$259.95
6-1507754-670	18 in	Specify	Chrome	Specify	\$259.95
6-1507755-670	18 in	Specify	Specify	Specify	\$252.95
6-1507756-670	16 in	Specify	Chrome	Specify	\$252.95
6-1507757-670	16 in	Specify	Specify	Specify	\$246.95
6-1507758-670	14 in	Specify	Chrome	Specify	\$246.95
6-1507759-670	14 in	Specify	Specify	Specify	\$239.95
6-5002485-670	12 in	Specify	Chrome	Specify	\$239.95
6-5002493-670	12 in	Specify	Specify	Specify	\$232.95

Item #	Description	List Price
6-1496629-670	Adjustable-Height Chair Dolly	\$286.95



Designed to offer optimal seat motion



Featuring the NeoClass® ribless smooth back design

**Classroom Select® NeoMove® Smooth Back Elliptical Cantilever Movement Chair**

The ability to move in an environment is proven to enhance focus, concentration, and attentiveness. Bonded rubber shock mounts allow free mobility, providing optimum controlled motion. With the most innovative design, comfort, and durability, this chair is your solution to student movement. The smooth, sculptured shell design creates a contemporary look while enhancing ease of cleaning. Sleek shell secures to a sturdy, modern 3/4" x 1-3/8" elliptical 14-gauge steel frame available in chrome, black powdercoat, or titanium powdercoat. Offered in an A+ seat shell size that is wider and more accommodating. The waterfall seat edge and contoured back bring ergonomic comfort, while openings at the top and bottom of the shell boost airflow and provide easy portability. Assembled.

Item #	Seat Height	Seat and Back Color	Frame Color	Glide/Caster Type	List Price
6-1503636-670	20 in A+	Specify	Chrome	Specify	\$306.95
6-1503637-670	20 in A+	Specify	Specify	Specify	\$299.95
6-1503638-670	18 in A+	Specify	Chrome	Specify	\$299.95
6-1503639-670	18 in A+	Specify	Specify	Specify	\$292.95
6-1503640-670	18 in	Specify	Chrome	Specify	\$292.95
6-1503641-670	18 in	Specify	Specify	Specify	\$286.95
6-1503642-670	16 in	Specify	Chrome	Specify	\$286.95
6-1503643-670	16 in	Specify	Specify	Specify	\$279.95
6-1503644-670	14 in	Specify	Chrome	Specify	\$279.95
6-1503645-670	14 in	Specify	Specify	Specify	\$272.95

Item #	Description	List Price
6-1496629-670	Adjustable-Height Chair Dolly	\$286.95





Refer to pages 60-61 for color options.



PRODUCT CERTIFIED FOR LOW CHEMICAL EMISSIONS: UL.COM/SGG UL 2818



Featuring a smooth back design

### Classroom Select® Inspo® Four Leg Chair

It's our most versatile classroom chair offering yet! The chair is meant to meet the needs of any classroom environment offering comfort, ease of movement, updated design, and ergonomics. The waterfall seat edge and contoured back bring ergonomic comfort, while an opening at the top provides easy portability. Hidden hardware adds simplicity and elegance to the design. The 20" A+ and 18" A+ options provide a wider, more accommodating seat size. The sleek 3/4" round tube frame in 15-gauge steel is reinforced with an inner 9/16" 17-gauge, steel tube that offers strength, durability, and stability while still looking modern and pleasing to the eye. Select from a chrome, black, or titanium powdercoat frame. Available in your choice of nylon, steel, felt, or rubber glides. Assembled.



Item #	Seat Height	Seat and Back Color	Frame Color	Glide/Caster Type	List Price
6-5002954-670	20 in A+	Specify	Chrome	Specify	<b>\$139.95</b>
6-5002951-670	20 in A+	Specify	Specify	Specify	<b>\$132.95</b>
6-5002957-670	18 in A+	Specify	Chrome	Specify	<b>\$132.95</b>
6-5002955-670	18 in A+	Specify	Specify	Specify	<b>\$126.95</b>
6-5002937-670	18 in	Specify	Chrome	Specify	<b>\$126.95</b>
6-5002939-670	18 in	Specify	Specify	Specify	<b>\$119.95</b>
6-5002949-670	16 in	Specify	Chrome	Specify	<b>\$119.95</b>
6-5002958-670	16 in	Specify	Specify	Specify	<b>\$112.95</b>
6-5002941-670	14 in	Specify	Chrome	Specify	<b>\$112.95</b>
6-5002947-670	14 in	Specify	Specify	Specify	<b>\$106.95</b>
6-5002953-670	12 in	Specify	Chrome	Specify	<b>\$106.95</b>
6-5002959-670	12 in	Specify	Specify	Specify	<b>\$99.95</b>



Featuring a smooth back design



### Classroom Select® Inspo® Elliptical Four Leg Chair

Featuring an elliptical steel frame with superior strength, the Classroom Select® Inspo® Elliptical Four Leg chair provides a modern look for today's classroom. The waterfall seat edge and contoured back bring ergonomic comfort, while the opening at the top provides easy portability. The 20" A+ and 18" A+ versions provide a wider, more accommodating seat size. Hidden hardware adds simplicity and elegance to the design. The sleek 3/4" W x 1-1/2" D elliptical frame in 14-gauge steel is reinforced with an inner 9/16" 17-gauge, steel tube that offers strength, durability, and stability with a contemporary flare. Available frame color options are chrome, black, or titanium. Choose from nylon, steel, felt or rubber glides. Assembled.

Item #	Seat Height	Seat and Back Color	Frame Color	Glide/Caster Type	List Price
6-5002952-670	20 in A+	Specify	Chrome	Specify	<b>\$159.95</b>
6-5002956-670	20 in A+	Specify	Specify	Specify	<b>\$152.95</b>
6-5002943-670	18 in A+	Specify	Chrome	Specify	<b>\$152.95</b>
6-5002950-670	18 in A+	Specify	Specify	Specify	<b>\$146.95</b>
6-5002960-670	18 in	Specify	Chrome	Specify	<b>\$146.95</b>
6-5002944-670	18 in	Specify	Specify	Specify	<b>\$139.95</b>
6-5002945-670	16 in	Specify	Chrome	Specify	<b>\$139.95</b>
6-5002946-670	16 in	Specify	Specify	Specify	<b>\$132.95</b>
6-5002938-670	14 in	Specify	Chrome	Specify	<b>\$132.95</b>
6-5002942-670	14 in	Specify	Specify	Specify	<b>\$126.95</b>
6-5002940-670	12 in	Specify	Chrome	Specify	<b>\$126.95</b>
6-5002948-670	12 in	Specify	Specify	Specify	<b>\$119.95</b>



PRODUCT CERTIFIED FOR LOW CHEMICAL EMISSIONS: UL.COM/SGG UL 2818



Refer to pages 60-61 for color options.



Featuring the NeoClass® ribless smooth back design

### Classroom Select® NeoClass® Smooth Back Four Leg Chair

The sculptured polypropylene smooth-back shell features a waterfall seat edge and contoured back for ergonomic comfort. Openings at the top and bottom of the shell boost airflow and provide easy portability. A+ shell options offer a wider, more accommodating seat size. The frame is made from 1-1/8", 18-gauge tubular steel with options to select a chrome, black powdercoat, or titanium powdercoat frame color. Choose from nylon, steel, felt, or rubber glides. Optional field installed book basket available for 20" A+, 18" A+ and 18" sizes. Assembled.

Quickship available in 14", 16", 18", and 18"A+ sizes, with chrome frame, nylon glides and your choice of Cardinal (Red), Tangerine, Lime, Marine (Royal Blue), Imperial (Navy Blue) or Ebony (Black) seat color.

Item #	Seat Height	Seat and Back Color	Frame Color	Glide/Caster Type	List Price
6-1496343-670	20 in A+	Specify	Chrome	Specify	\$111.95
6-1496344-670	20 in A+	Specify	Specify	Specify	\$104.95
6-1496345-670	18 in A+	Specify	Chrome	Specify	\$104.95
6-1496346-670	18 in A+	Specify	Specify	Specify	\$98.95
6-1496347-670	18 in	Specify	Chrome	Specify	\$98.95
6-1496348-670	18 in	Specify	Specify	Specify	\$91.95
6-1496349-670	16 in	Specify	Chrome	Specify	\$91.95
6-1496350-670	16 in	Specify	Specify	Specify	\$84.95
6-1496351-670	14 in	Specify	Chrome	Specify	\$87.95
6-1496352-670	14 in	Specify	Specify	Specify	\$80.95
6-5002487-670	12 in	Specify	Chrome	Specify	\$84.95
6-5002491-670	12 in	Specify	Black	Specify	\$78.95

Item #	Description	List Price
9-1362136-670	Chrome Wire Book Basket	\$22.95
9-1441266-670	Black Wire Book Basket	\$22.95
6-1496629-670	Adjustable-Height Chair Dolly	\$286.95

### Classroom Select® NeoClass® Smooth Back Elliptical Four Leg Chair

Featuring a durable, stable elliptical steel frame and smooth-back, the NeoClass® Elliptical Four-Leg Chair provides a clean look for today's classroom. A waterfall seat edge and contoured back with openings at the top and bottom provide ergonomic comfort and boost airflow, while also facilitating today's collaborative classroom learning styles. The 3/4" x 1-3/8" elliptical 14-gauge steel frame is available in chrome, black powdercoat, or titanium powdercoat. Your choice of nylon, steel, felt, or rubber glides. The 18" A+ and 20" A+ versions provide a wider, more accommodating seat size. Assembled.



Featuring the NeoClass® ribless smooth back design



Item #	Seat Height	Seat and Back Color	Frame Color	Glide/Caster Type	List Price
6-1496373-670	20 in A+	Specify	Chrome	Specify	\$131.95
6-1496375-670	20 in A+	Specify	Specify	Specify	\$124.95
6-1496376-670	18 in A+	Specify	Chrome	Specify	\$124.95
6-1496377-670	18 in A+	Specify	Specify	Specify	\$118.95
6-1496378-670	18 in	Specify	Chrome	Specify	\$118.95
6-1496379-670	18 in	Specify	Specify	Specify	\$111.95
6-1496380-670	16 in	Specify	Chrome	Specify	\$111.95
6-1496381-670	16 in	Specify	Specify	Specify	\$104.95
6-1496382-670	14 in	Specify	Chrome	Specify	\$107.95
6-1496383-670	14 in	Specify	Specify	Specify	\$100.95
6-5002488-670	12 in	Specify	Chrome	Specify	\$104.95
6-5002490-670	12 in	Specify	Specify	Specify	\$98.95

Item #	Description	List Price
6-1496629-670	Adjustable-Height Chair Dolly	\$286.95







Refer to pages 60-61 for color options.



PRODUCT CERTIFIED FOR LOW CHEMICAL EMISSIONS: UL.COM/IGG UL 2818



Shown with Optional Wire Book Basket



Shown with Optional Seat and Back Pads

### Classroom Select® Contemporary Four Leg Chair

Well-fitting, ergonomic chair with tubular steel frame is designed to offer upper back and lumbar support, with side-to-side flexibility that adjusts to a variety of body profiles. Available in various sizes, plus an extra wide A+ XL seat with a 30% larger surface area than the standard 18" chair. The unique design prevents shifting or leaning when stacked. The legs are 1-1/8" 18-gauge tubular steel (16-gauge for 18" A+ and 20" A+) and feature full nickel chrome or black powdercoat frame. Four self-leveling glide options. Powdercoat matching frame color available in smaller chair shell sizes. Optional field installed book basket available for 20" A+, 18" A+ and 18" chairs. Assembled. Please order a minimum of four chairs. **Quickship available in 10", 12", 14", 16", 18" and 18" A+ seat heights, with chrome frame, nylon glides and your choice of Marine (Royal Blue), Imperial (Navy Blue) or Ebony (Black) seat colors.**

Item #	Seat Height	Seat and Back Color	Fabric Color	Frame Color	Glide/Caster Type	List Price
6-1444516-670	20 in A+	Specify	Specify	Chrome	Specify	\$166.95
6-1444517-670	20 in A+	Specify	Specify	Black	Specify	\$159.95
6-1441232-670	20 in A+	Specify	-	Chrome	Specify	\$99.95
6-1441233-670	20 in A+	Specify	-	Black	Specify	\$92.95
6-1441240-670	18 in A+	Specify	Specify	Chrome	Specify	\$159.95
6-1441241-670	18 in A+	Specify	Specify	Black	Specify	\$152.95
6-1357322-670	18 in A+	Specify	-	Chrome	Specify	\$92.95
6-1395298-670	18 in A+	Specify	-	Black	Specify	\$86.95
6-1441242-670	18 in	Specify	Specify	Chrome	Specify	\$152.95
6-1441243-670	18 in	Specify	Specify	Black	Specify	\$146.95
6-1357323-670	18 in	Specify	-	Chrome	Specify	\$86.95
6-1395299-670	18 in	Specify	-	Black	Specify	\$79.95
6-1357324-670	16 in	Specify	-	Chrome	Specify	\$79.95
6-1395305-670	16 in	Specify	-	Black	Specify	\$72.95
6-1426053-670	16 in	Specify	-	Matching	Specify	\$72.95
6-1357325-670	14 in	Specify	-	Chrome	Specify	\$75.95
6-1395306-670	14 in	Specify	-	Black	Specify	\$68.95
6-1426052-670	14 in	Specify	-	Matching	Specify	\$68.95
6-1357326-670	12 in	Specify	-	Chrome	Specify	\$72.95
6-1395307-670	12 in	Specify	-	Black	Specify	\$66.95
6-1426051-670	12 in	Specify	-	Matching	Specify	\$66.95
6-1395296-670	10 in	Specify	-	Chrome	Specify	\$70.95
6-1395308-670	10 in	Specify	-	Black	Specify	\$63.95
6-1426050-670	10 in	Specify	-	Matching	Specify	\$63.95
6-1395297-670	8 in	Specify	-	Chrome	Specify	\$68.95
6-1395309-670	8 in	Specify	-	Black	Specify	\$62.95
6-1426048-670	8 in	Specify	-	Matching	Specify	\$62.95
Item #	Description					List Price
9-1362136-670	Chrome Wire Book Basket					\$22.95
9-1441266-670	Black Wire Book Basket					\$22.95
6-1496629-670	Adjustable-Height Chair Dolly					\$286.95

**24-hr Quickship** available for items 1357323, 1357324, 1357325 and 1357326 with Imperial (Navy Blue) or Marine (Royal Blue) seat colors and nylon glides in quantities up to 100 each. Applies to orders containing 24 hour quick ship items only.

**CLASSROOM  
SELECT**



PRODUCT CERTIFIED  
FOR LOW CHEMICAL  
EMISSIONS:  
UL.COM/CGG  
UL 2818



**PLEASE  
SPECIFY  
COLOR  
CHOICE**

Refer to pages 60-61  
for color options.



Shown with Optional  
Wire Book Basket



**Classroom Select® Traditional Four Leg Chair**

This lightweight soft plastic polypropylene chair shell promotes good circulation, relieves pressure points, and provides flexibility in the upper back while supporting the lower back. The legs are 1-1/8" 18-gauge tubular steel (16-gauge for 18-1/2" A+ and 20-1/2" A+). Available in full chrome frame or black powdercoat and stack 10 high. Select from nylon, steel, felt, or rubber glides. Also available in your choice of the A Shell or the larger, more accommodating A+ Shell size. Please order a minimum of four. Optional field installed book basket available for 20-1/2" A+, 18-1/2" A+ and 17-1/2". Assembled.

**Quickship available in 11-1/2", 13-1/2", 15-1/2", 17-1/2", and 18-1/2" A+ seat heights, with chrome frame, nylon glides and your choice of Marine (Royal Blue), Imperial (Navy Blue) or Ebony (Black) seat colors.**



Height adjustable Chair  
Dolly is compatible with all  
Classroom Select Stack Chairs

Item #	Seat Height	Seat and Back Color	Frame Color	List Price
6-1441872-670	20-1/2 in A+	Specify	Chrome	\$99.95
6-1441873-670	20-1/2 in A+	Specify	Black	\$92.95
6-1357315-670	18-1/2 in A+	Specify	Chrome	\$92.95
6-1395302-670	18-1/2 in A+	Specify	Black	\$86.95
6-1357316-670	17-1/2 in	Specify	Chrome	\$86.95
6-1395301-670	17-1/2 in	Specify	Black	\$79.95
6-1357317-670	15-1/2 in	Specify	Chrome	\$79.95
6-1395300-670	15-1/2 in	Specify	Black	\$72.95
6-1357318-670	13-1/2 in	Specify	Chrome	\$75.95
6-1425582-670	13-1/2 in	Specify	Black	\$68.95
6-1357319-670	11-1/2 in	Specify	Chrome	\$72.95
6-1415401-670	11-1/2 in	Specify	Black	\$66.95

Item #	Description	List Price
9-1362135-670	Chrome Wire Book Basket	\$24.95
9-1441265-670	Black Wire Book Basket	\$24.95
6-1496629-670	Adjustable Height Chair Dolly	\$286.95

**Classroom Select® Royal Seating®  
4100 Hard Plastic Four Leg Chair**

The Classroom Select® Royal Seating® 4100 Hard Plastic Four Leg Chair features a form-fitted seat and back constructed of 5/8" hard plastic that is acid and scratch resistant. Edges are smooth and rounded for comfort and easy cleaning, and there are no exposed fasteners. Select from chrome or black powercoat frame. Standard nylon glides. Stacks up to 5 high. Optional field installed book basket available for the 18" chairs. Assembled.

Item #	Seat Height	Seat and Back Color	Frame Color	List Price
6-1363857-670	18 in	Specify	Chrome	\$152.95
6-1363856-670	18 in	Specify	Black	\$146.95
6-1363859-670	16 in	Specify	Chrome	\$146.95
6-1363858-670	16 in	Specify	Black	\$139.95
6-1480725-670	14 in	Specify	Chrome	\$142.95
6-1480726-670	14 in	Specify	Black	\$135.95
6-1480723-670	12 in	Specify	Chrome	\$139.95
6-1480724-670	12 in	Specify	Black	\$132.95

Item #	Description	List Price
9-1362135-670	Chrome Wire Book Basket	\$24.95
9-1441265-670	Black Wire Book Basket	\$24.95
6-1496629-670	Adjustable Height Chair Dolly	\$286.95





Refer to pages 60-61 for color options.



PRODUCT CERTIFIED FOR LOW CHEMICAL EMISSIONS: UL.COM/GG UL 2818



**Classroom Select® Royal Seating® 1100 Four Leg Chair**

The patented v-back shell provides ventilation and the front waterfall lip gives comfortable support. Available in chrome, black, or matching frame with leveling glides in your choice of nylon, steel, felt or rubber. Also available with padded seat and back. Select from various popular sizes, including the A+ size that offers a 30% larger seat surface. Chairs will stack 10-12 high for convenient storage. An easy to install optional book basket is offered in both chrome and black. Assembled.

**Quickship available in 10", 12", 14", 16", 18" and 18" A+ seat heights, with chrome frame, nylon glides and your choice of Marine (Royal Blue), Imperial (Navy Blue) or Ebony (Black) seat colors.**



Item #	Seat Height	Seat and Back Color	Fabric Color	Frame Color	Glide/Caster Type	List Price
6-1458228-670	18 in A+	Specify	Specify	Chrome	Specify	\$159.95
6-1458229-670	18 in A+	Specify	Specify	Black	Specify	\$152.95
6-1362379-670	18 in A+	Specify	-	Chrome	Specify	\$92.95
6-1363846-670	18 in A+	Specify	-	Black	Specify	\$86.95
6-1458226-670	18 in	Specify	Specify	Chrome	Specify	\$152.95
6-1458227-670	18 in	Specify	Specify	Black	Specify	\$146.95
6-1362378-670	18 in	Specify	-	Chrome	Specify	\$86.95
6-1363847-670	18 in	Specify	-	Black	Specify	\$79.95
6-1362377-670	16 in	Specify	-	Chrome	Specify	\$79.95
6-1363848-670	16 in	Specify	-	Black	Specify	\$72.95
6-1351798-670	16 in	Specify	-	Matching	Specify	\$72.95
6-1362376-670	14 in	Specify	-	Chrome	Specify	\$75.95
6-1363849-670	14 in	Specify	-	Black	Specify	\$68.95
6-1351797-670	14 in	Specify	-	Matching	Specify	\$68.95
6-1362375-670	12 in	Specify	-	Chrome	Specify	\$72.95
6-1363850-670	12 in	Specify	-	Black	Specify	\$66.95
6-1351795-670	12 in	Specify	-	Matching	Specify	\$66.95
6-678959-670	10 in	Specify	-	Chrome	Specify	\$71.95
6-1458742-670	10 in	Specify	-	Black	Specify	\$64.95
6-1351796-670	10 in	Specify	-	Matching	Specify	\$64.95
6-1476993-670	8 in	Specify	-	Chrome	Specify	\$70.95
6-1476995-670	8 in	Specify	-	Black	Specify	\$63.95
6-1476999-670	8 in	Specify	-	Matching	Specify	\$63.95

Item #	Description	List Price
9-1362135-670	Chrome Wire Book Basket	\$24.95
9-1441265-670	Black Wire Book Basket	\$24.95
6-1496629-670	Adjustable-Height Chair Dolly	\$286.95



Chrome Frame



Matching Frame



Shown with Optional Wire Book Rack



**CLASSROOM  
SELECT**



PRODUCT CERTIFIED  
FOR LOW CHEMICAL  
EMISSIONS:  
UL.COM/IGG  
UL 2818



**PLEASE  
SPECIFY  
COLOR  
CHOICE**

Refer to pages 60-61  
for color options.



Chrome Frame



Black Frame



**Classroom Select® Contemporary Chair with Ball Glides**

Ergonomic soft plastic chair is shaped to offer upper back and lumbar support, with side-to-side flexibility that adjusts to a variety of body profiles. Progressive waterfall front seat edge provides comfort and support. Unique design prevents shifting or leaning when stacked. Frames are 1-1/8" 18-gauge tubular steel and feature colored ball glides to match the chair shell. Assembled. **Please order a minimum of 4.**

Item #	Seat Height	Seat And Back Color	Frame Color	List Price
6-1415413-670	16 in	Specify	Chrome	\$92.95
6-1425929-670	16 in	Specify	Black	\$86.95
6-1415412-670	16 in	Specify	Matching	\$86.95
6-1415411-670	14 in	Specify	Chrome	\$88.95
6-1425928-670	14 in	Specify	Black	\$82.95
6-1415410-670	14 in	Specify	Matching	\$82.95
6-1415409-670	12 in	Specify	Chrome	\$86.95
6-1425927-670	12 in	Specify	Black	\$79.95
6-1415408-670	12 in	Specify	Matching	\$79.95
6-1415407-670	10 in	Specify	Chrome	\$83.95
6-1425926-670	10 in	Specify	Black	\$76.95
6-1415406-670	10 in	Specify	Matching	\$76.95
6-1415405-670	8 in	Specify	Chrome	\$82.95
6-1425925-670	8 in	Specify	Black	\$75.95
6-1415404-670	8 in	Specify	Matching	\$75.95

**Height adjustable chair dolly is compatible with all Classroom Select stack chairs.**

Item #	Description	List Price
6-1496629-670	Adjustable-Height Chair Dolly	\$286.95



Chrome Frame



Matching Frame

**Classroom Select® Royal Seating® 1100 Chair with Ball Glides**

Designed to promote correct seating posture, the v-back shell provides a comfortable seating option for any classroom. Choose chrome metal, black finish, or matching color frame. Features durable ball glides that are ideal for a variety of flooring options and are matched to your seat color choice. Stacks 10-12 chairs high for convenient storage. Assembled. **Please order a minimum of four.**

Item #	Seat Height	Seat And Back Color	Frame Color	List Price
6-1478916-670	16 in	Specify	Chrome	\$92.95
6-1478184-670	16 in	Specify	Black	\$86.95
6-1477480-670	16 in	Specify	Matching	\$86.95
6-1458244-670	14 in	Specify	Chrome	\$88.95
6-1478182-670	14 in	Specify	Black	\$82.95
6-1458245-670	14 in	Specify	Matching	\$82.95
6-1458242-670	12 in	Specify	Chrome	\$86.95
6-1478181-670	12 in	Specify	Black	\$79.95
6-1458243-670	12 in	Specify	Matching	\$79.95
6-1458240-670	10 in	Specify	Chrome	\$84.95
6-1478180-670	10 in	Specify	Black	\$78.95
6-1458241-670	10 in	Specify	Matching	\$78.95
6-1478179-670	8 in	Specify	Chrome	\$83.95
6-1476997-670	8 in	Specify	Black	\$76.95
6-1477001-670	8 in	Specify	Matching	\$76.95

Item #	Description	List Price
6-1496629-670	Adjustable-Height Chair Dolly	\$286.95

**PLEASE SPECIFY COLOR CHOICE**  
Refer to pages 60-61 for color options.



PRODUCT CERTIFIED FOR LOW CHEMICAL EMISSIONS: UL.COM/GG UL 2818

**CLASSROOM SELECT**

**Classroom Select® Inspo® Cantilever Chair**

The Classroom Select® Inspo® Cantilever Chair offers a contemporary design with a comfortable contoured seat with water fall edge. The opening at the top provides easy portability. Hidden hardware adds simplicity and elegance to the design. The sleek 1-1/8" round tube frame in 14-gauge steel offers strength, durability, and stability while still looking modern. The cantilever-style frame adds comfort for students by offering generous leg room. Select from chrome, black powdercoat, or titanium powdercoat frame. Available in your choice of nylon, steel, felt, or rubber glides. Also available in your choice of the A shell or the larger, more accommodating A+ shell size. Assembled.

Item #	Seat Height	Seat and Back Color	Frame Color	Glide/Caster Type	List Price
6-5002982-670	20 in A+	Specify	Chrome	Specify	\$179.95
6-5002979-670	20 in A+	Specify	Specify	Specify	\$172.95
6-5002980-670	18 in A+	Specify	Chrome	Specify	\$172.95
6-5002984-670	18 in A+	Specify	Specify	Specify	\$166.95
6-5002977-670	18 in	Specify	Chrome	Specify	\$166.95
6-5002976-670	18 in	Specify	Specify	Specify	\$159.95
6-5002962-670	16 in	Specify	Chrome	Specify	\$159.95
6-5002961-670	16 in	Specify	Specify	Specify	\$152.95
6-5002964-670	14 in	Specify	Chrome	Specify	\$152.95
6-5002968-670	14 in	Specify	Specify	Specify	\$146.95
6-5002978-670	12 in	Specify	Chrome	Specify	\$146.95
6-5002970-670	12 in	Specify	Specify	Specify	\$139.95



Featuring a smooth back design



Featuring a smooth back design

**Classroom Select® Inspo® Elliptical Cantilever Chair**

This chair is meant to meet the needs of any classroom environment offering comfort, ease of movement, updated design, and ergonomics. Made of soft plastic polypropylene, the waterfall seat edge and contoured back bring ergonomic comfort, while opening at the top provide easy portability. Hidden hardware adds simplicity and elegance to the design. An elliptical frame offers strength, durability, and stability while still looking modern and pleasing to the eye. Frame is 3/4" by 1-1/2" elliptical 14-gauge steel with a frame reinforcement that is an inner 3/16" round tube 17-gauge steel. The cantilever-style frame adds comfort for students by offering generous leg room. Available in chrome, black powdercoat, or titanium powdercoat frame options. Also available in your choice of the A shell or the larger, more accommodating A+ shell size. Assembled.

Item #	Seat Height	Seat and Back Color	Frame Color	Glide/Caster Type	List Price
6-5002969-670	20 in A+	Specify	Chrome	Specify	\$186.95
6-5002975-670	20 in A+	Specify	Specify	Specify	\$179.95
6-5002981-670	18 in A+	Specify	Chrome	Specify	\$179.95
6-5002974-670	18 in A+	Specify	Specify	Specify	\$172.95
6-5002966-670	18 in	Specify	Chrome	Specify	\$172.95
6-5002972-670	18 in	Specify	Specify	Specify	\$166.95
6-5002971-670	16 in	Specify	Chrome	Specify	\$166.95
6-5002967-670	16 in	Specify	Specify	Specify	\$159.95
6-5002973-670	14 in	Specify	Chrome	Specify	\$159.95
6-5002983-670	14 in	Specify	Specify	Specify	\$152.95

**CLASSROOM  
SELECT** 



PRODUCT CERTIFIED  
FOR LOW CHEMICAL  
EMISSIONS:  
UL COM1GG  
UL 2818



**PLEASE  
SPECIFY  
COLOR  
CHOICE**

Refer to pages 60-61  
for color options.



Featuring the NeoClass® ribless smooth back design



**Classroom Select® NeoClass® Smooth Back Cantilever Chair**

The sculptured polypropylene shell offers a smooth, contemporary look, and features a 1-1/8", 16-gauge tubular steel frame. The waterfall seat edge and contoured back bring ergonomic comfort, while openings at the top and bottom of the shell boost airflow and provide easy portability. A+ shell offers a wider, more accommodating seat size. Four radius corners allow the chair to easily slide on carpet. Choose from nylon, steel, felt, or rubber glides. Select from a chrome, black powdercoat, or titanium powdercoat frame. Assembled.

Item #	Seat Height	Seat and Back Color	Frame Color	Glide/Caster Type	List Price
6-1496363-670	20 in A+	Specify	Chrome	Specify	\$151.95
6-1496364-670	20 in A+	Specify	Specify	Specify	\$144.95
6-1496365-670	18 in A+	Specify	Chrome	Specify	\$144.95
6-1496366-670	18 in A+	Specify	Specify	Specify	\$138.95
6-1496367-670	18 in	Specify	Chrome	Specify	\$138.95
6-1496368-670	18 in	Specify	Specify	Specify	\$131.95
6-1496369-670	16 in	Specify	Chrome	Specify	\$131.95
6-1496370-670	16 in	Specify	Specify	Specify	\$124.95
6-1496371-670	14 in	Specify	Chrome	Specify	\$127.95
6-1496372-670	14 in	Specify	Specify	Specify	\$120.95
6-5004735-670	12 in	Specify	Chrome	Specify	\$124.95
6-5004736-670	12 in	Specify	Specify	Specify	\$118.95

Item #	Description	List Price
6-1496629-670	Adjustable Height Chair Dolly	\$286.95

**Classroom Select® NeoClass® Smooth Back Elliptical Cantilever Chair**

Ergonomics meets versatility in this sleek polypropylene chair with a durable, stable 3/4" x 1-3/8" elliptical 14-gauge steel frame. The waterfall seat edge and contoured back with openings at the top and bottom enhances ergonomic comfort and boosts airflow, while also facilitating today's modular, collaborative classroom learning styles. The frame is available in chrome, black powdercoat, or titanium powdercoat. A+ options offer a wider, more accommodating seat size. Select from your choice of nylon, steel, felt or rubber glides. Assembled.



Featuring the NeoClass® ribless smooth back design



Item #	Seat Height	Seat and Back Color	Frame Color	Glide/Caster Type	List Price
6-1499024-670	20 in A+	Specify	Chrome	Specify	\$191.95
6-1499025-670	20 in A+	Specify	Specify	Specify	\$184.95
6-1499026-670	18 in A+	Specify	Chrome	Specify	\$184.95
6-1499027-670	18 in A+	Specify	Specify	Specify	\$178.95
6-1499028-670	18 in	Specify	Chrome	Specify	\$178.95
6-1499029-670	18 in	Specify	Specify	Specify	\$171.95
6-1499030-670	16 in	Specify	Chrome	Specify	\$171.95
6-1499031-670	16 in	Specify	Specify	Specify	\$164.95
6-1499032-670	14 in	Specify	Chrome	Specify	\$167.95
6-1499033-670	14 in	Specify	Specify	Specify	\$160.95

Item #	Description	List Price
6-1496629-670	Adjustable Height Chair Dolly	\$286.95





Refer to pages 60-61 for color options.



PRODUCT CERTIFIED FOR LOW CHEMICAL EMISSIONS: UL.COM/IGG UL 2818



Shown with the Classroom Select® Contemporary Cantilever Desk (pg. 50)

### Classroom Select® Contemporary Cantilever Chair

The Classroom Select® Contemporary Cantilever chair features the ergonomically designed one-piece soft plastic polypropylene Contemporary shell on a sturdy cantilever chair. A convenient handhold in the upper back allows for easy carrying. There are four strategically placed rubber bumpers on the underside of the seat to prevent marking when the chair is placed on a desk for classroom cleaning. Choose from a chrome or black powdercoat frame. Also available in A+ shell with a wider, more accommodating seat size. Select from your choice of nylon, steel, felt, or rubber glides. Assembled.



Featuring 15 contoured ribs for greater flexibility



Item #	Seat Height	Seat and Back Color	Fabric Color	Frame Color	Glide/Caster Type	List Price
6-1496317-670	20 in A+	Specify	Specify	Chrome	Specify	\$232.95
6-1496325-670	20 in A+	Specify	Specify	Black	Specify	\$226.95
6-1496314-670	20 in A+	Specify	-	Chrome	Specify	\$166.95
6-1496319-670	20 in A+	Specify	-	Black	Specify	\$159.95
6-1496318-670	18 in A+	Specify	Specify	Chrome	Specify	\$226.95
6-1496326-670	18 in A+	Specify	Specify	Black	Specify	\$219.95
6-1496315-670	18 in A+	Specify	-	Chrome	Specify	\$159.95
6-1496320-670	18 in A+	Specify	-	Black	Specify	\$152.95
6-1448351-670	18 in	Specify	Specify	Chrome	Specify	\$219.95
6-1496324-670	18 in	Specify	Specify	Black	Specify	\$212.95
6-1388741-670	18 in	Specify	-	Chrome	Specify	\$152.95
6-1496321-670	18 in	Specify	-	Black	Specify	\$146.95
6-1388742-670	16 in	Specify	-	Chrome	Specify	\$146.95
6-1496322-670	16 in	Specify	-	Black	Specify	\$139.95
6-1496316-670	14 in	Specify	-	Chrome	Specify	\$142.95
6-1496323-670	14 in	Specify	-	Black	Specify	\$135.95

Item #	Description	List Price
6-1496629-670	Adjustable Height Chair Dolly	\$286.95



PRODUCT CERTIFIED FOR LOW CHEMICAL EMISSIONS: UL.COM/IGG UL 2818



**PLEASE SPECIFY COLOR CHOICE**

Refer to pages 60-61 for color options.



Featuring the NeoClass ribless smooth back design



**Classroom Select® NeoClass® Smooth Back Sled Base Chair**

This distinctive polypropylene chair with a sturdy 3/4", 16-gauge tubular steel frame features a smooth back and subtle pattern that creates a contemporary look while enhancing ease of cleaning. The waterfall seat edge and contoured shape offers ergonomic support, and side-to-side flexibility, while two openings on the top and bottom of the shell boost airflow and allow easier portability. The sled base frame slides easily over any floor surface and comes in your choice of chrome or black powdercoat with felt glides. The 18" A+ and 20" A+ versions offer a wider, more accommodating seat size. Optional book basket available to be installed below chair. Assembled.

Item #	Seat Height	Seat and Back Color	Frame Color	List Price
6-1496353-670	20 in A+	Specify	Chrome	\$151.95
6-1496354-670	20 in A+	Specify	Black	\$144.95
6-1496355-670	18 in A+	Specify	Chrome	\$144.95
6-1496356-670	18 in A+	Specify	Black	\$138.95
6-1496357-670	18 in	Specify	Chrome	\$138.95
6-1496358-670	18 in	Specify	Black	\$131.95
6-1496359-670	16 in	Specify	Chrome	\$131.95
6-1496360-670	16 in	Specify	Black	\$124.95
6-1496361-670	14 in	Specify	Chrome	\$127.95
6-1496362-670	14 in	Specify	Black	\$120.95

Item #	Description	List Price
9-1362136-670	Chrome Wire Book Basket	\$22.95
9-1441266-670	Black Wire Book Basket	\$22.95
6-1496629-670	Adjustable Height Chair Dolly	\$286.95
9-1481097-670	Snap on Felt Glide	\$1.65

**Classroom Select® Contemporary Sled Base Chair**

Well-fitting, ergonomic soft plastic chair with tubular steel frame shaped to offer upper back and lumbar support with side-to-side flexibility that adjusts to an assortment of body profiles. The contour shape provides flexibility at the upper back while supporting the lower back. The attractive sled base offers easy movement for both student and staff and is made of high-strength steel tubing. Available in your choice of the A shell or the larger, more accommodating A+ shell size. Chairs can stack five high. Optional book basket available to be installed below chair. Assembled.

Item #	Seat Height	Seat and Back Color	Fabric Color	Frame Color	List Price
6-1508330-670	20 in A+	Specify	Specify	Chrome	\$212.95
6-1508331-670	20 in A+	Specify	Specify	Black	\$206.95
6-1498949-670	20 in A+	Specify	-	Chrome	\$146.95
6-1498950-670	20 in A+	Specify	-	Black	\$139.95
6-1508328-670	18 in A+	Specify	Specify	Chrome	\$206.95
6-1508329-670	18 in A+	Specify	Specify	Black	\$199.95
6-1496327-670	18 in A+	Specify	-	Chrome	\$139.95
6-1496328-670	18 in A+	Specify	-	Black	\$132.95
6-1508332-670	18 in	Specify	Specify	Chrome	\$199.95
6-1508333-670	18 in	Specify	Specify	Black	\$192.95
6-1441216-670	18 in	Specify	-	Chrome	\$132.95
6-1441217-670	18 in	Specify	-	Black	\$126.95
6-1441218-670	16 in	Specify	-	Chrome	\$126.95
6-1441219-670	16 in	Specify	-	Black	\$119.95
6-1496329-670	14 in	Specify	-	Chrome	\$122.95
6-1496330-670	14 in	Specify	-	Black	\$115.95

Item #	Description	List Price
9-1362136-670	Chrome Wire Book Basket	\$22.95
9-1441266-670	Black Wire Book Basket	\$22.95
6-1496629-670	Adjustable Height Chair Dolly	\$286.95
9-1481097-670	Snap on Felt Glide	\$1.65



Featuring 15 contoured ribs for greater flexibility



Refer to pages 60-61 for color options.



PRODUCT CERTIFIED FOR LOW CHEMICAL EMISSIONS: UL.COM/IGG UL 2818



### Classroom Select® Royal Seating® 1100 Sled Base Chair

Classroom Select® Royal Seating® 1100 Sled Base Chair features a v-back shell, providing ventilation, and waterfall edge for comfort on a 3/4", 16-gauge steel sled base frame. This versatile seating solution makes sliding chairs easy for any classroom configuration. Available in chrome or black powdercoat frame with optional felt glides. Optional field installed book basket fits 18" A+ and 18" sizes. Assembled.

Item #	Seat Height	Seat and Back Color	Fabric Color	Frame Color	List Price
6-1508334-670	18 in A+	Specify	Specify	Chrome	\$206.95
6-1508335-670	18 in A+	Specify	Specify	Black	\$199.95
6-1496331-670	18 in A+	Specify	-	Chrome	\$139.95
6-1496332-670	18 in A+	Specify	-	Black	\$132.95
6-1508336-670	18 in	Specify	Specify	Chrome	\$199.95
6-1508337-670	18 in	Specify	Specify	Black	\$192.95
6-1496333-670	18 in	Specify	-	Chrome	\$132.95
6-1496334-670	18 in	Specify	-	Black	\$126.95
6-1496335-670	16 in	Specify	-	Chrome	\$126.95
6-1496336-670	16 in	Specify	-	Black	\$119.95
6-1496337-670	14 in	Specify	-	Chrome	\$122.95
6-1496338-670	14 in	Specify	-	Black	\$115.95

Item #	Description	List Price
9-1362136-670	Chrome Wire Book Basket	\$22.95
9-1441266-670	Black Wire Book Basket	\$22.95
6-1496629-670	Adjustable Height Chair Dolly	\$286.95
9-1481097-670	Snap on Felt Glide	\$1.65



### Classroom Select® Traditional Sled Base Chair

The Classroom Select® Traditional Sled Base Chair features a one-piece, injection-molded polypropylene shell. The seat is reinforced with ribs that allow greater upper back flexibility while still supporting the lower back, mounted on a 3/4", 16-gauge steel sled base frame. Available in chrome or black powdercoat frame with optional felt glides. Optional field-installed book basket fits 20" A+, 18" A+, and 18" sizes. Assembled.

Item #	Seat Height	Seat and Back Color	Frame Color	List Price
6-1503578-670	20-1/2 in A+	Specify	Chrome	\$146.95
6-1503579-670	20-1/2 in A+	Specify	Black	\$139.95
6-1503576-670	18-1/2 in A+	Specify	Chrome	\$139.95
6-1503577-670	18-1/2 in A+	Specify	Black	\$132.95
6-1503574-670	17-1/2 in	Specify	Chrome	\$132.95
6-1503575-670	17-1/2 in	Specify	Black	\$126.95
6-1503572-670	15 1/2 in	Specify	Chrome	\$126.95
6-1503573-670	15-1/2 in	Specify	Black	\$119.95
6-1503570-670	13-1/2 in	Specify	Chrome	\$122.95
6-1503571-670	13-1/2 in	Specify	Black	\$115.95

Item #	Description	List Price
9-1362136-670	Chrome Wire Book Basket	\$22.95
9-1441266-670	Black Wire Book Basket	\$22.95
6-1496629-670	Adjustable Height Chair Dolly	\$286.95
9-1481097-670	Snap on Felt Glide	\$1.65





PRODUCT CERTIFIED FOR LOW CHEMICAL EMISSIONS: UL.COM/SGG UL 2818



Refer to pages 60-61 for color options.



**Classroom Select® Inspo® Chair with Fixed Arms and Casters**

It's our most versatile classroom chair offering yet, now with an added fixed armrest! The chair is meant to meet the needs of any classroom environment offering comfort, ease of movement, updated design, and ergonomics. The waterfall seat edge, contoured back, and armrests bring ergonomic comfort, while opening at the top provide easy portability. Hidden hardware adds simplicity and elegance to the design. The 18"A+ provides a wider, more accommodating seat size. The sleek 1" round tube frame in 16-gauge steel offers strength, durability, and stability while still looking modern and pleasing to the eye. Available standard in a titanium powdercoat frame and the chair shell is available in an array of polypropylene colors. Includes 2" diameter, urethane, twin swivel casters.

Item #	Product Dimensions	Seat Height	Seat and Back Color	Frame Color	Glide/Caster Type	List Price
6-5008634-670	20W x 20D x 33-1/4H in	18.5 A+	Specify	Titanium	Caster	\$192.95

**Classroom Select® Inspo® Chair With Casters**

This chair offers mobility, comfort, and an updated design. Made of soft polypropylene with a smooth back, the waterfall seat edge and contoured back bring ergonomic comfort, and the opening at the top provides portability. Hidden hardware adds simplicity and elegance to the design. The sleek 1" round tube frame in 16-gauge steel offers strength and stability. Available in chrome, black, or titanium powdercoat frame options. Includes 2" diameter, urethane, twin swivel casters. Also available in your choice of the A shell or the larger, more accommodating A+ shell size. Assembled.



Featuring a smooth back design



Item #	Seat Height	Seat and Back Color	Frame Color	List Price
6-5002925-670	20 in A+	Specify	Chrome	\$159.95
6-5002936-670	20 in A+	Specify	Specify	\$152.95
6-5002930-670	18 in A+	Specify	Chrome	\$152.95
6-5002919-670	18 in A+	Specify	Specify	\$146.95
6-5002927-670	18 in	Specify	Chrome	\$146.95
6-5002929-670	18 in	Specify	Specify	\$139.95
6-5002915-670	16 in	Specify	Chrome	\$139.95
6-5002922-670	16 in	Specify	Specify	\$132.95
6-5002928-670	14 in	Specify	Chrome	\$132.95
6-5002935-670	14 in	Specify	Specify	\$126.95

**Classroom Select® Inspo® Elliptical Chair With Casters**

Featuring a durable, stable, elliptical steel frame, the Classroom Select® Inspo® Elliptical Chair with Casters provides exceptional quality and a sleek modern appearance while offering the mobility needed in today's classroom environments. Made of soft polypropylene with a smooth back, the waterfall seat edge and contoured back bring ergonomic comfort, while the opening at the top provides portability. Hidden hardware adds simplicity and elegance to the design. Available in your choice of chrome, black, or titanium frame. Frame is 3/4" by 1-1/2" elliptical 14-gauge steel with inner frame reinforcement of 1/16" round tube 17-gauge. Includes 2" diameter, urethane, twin swivel casters. Also available in your choice of the A shell or the larger, more accommodating A+ shell size. Assembled.



Featuring a smooth back design



Item #	Seat Height	Seat and Back Color	Frame Color	List Price
6-5002918-670	20 in A+	Specify	Chrome	\$186.95
6-5002914-670	20 in A+	Specify	Specify	\$179.95
6-5002924-670	18 in A+	Specify	Chrome	\$179.95
6-5002921-670	18 in A+	Specify	Specify	\$172.95
6-5002916-670	18 in	Specify	Chrome	\$172.95
6-5002913-670	18 in	Specify	Specify	\$166.95
6-5002923-670	16 in	Specify	Chrome	\$166.95
6-5002932-670	16 in	Specify	Specify	\$159.95
6-5002931-670	14 in	Specify	Chrome	\$159.95
6-5002933-670	14 in	Specify	Specify	\$152.95

**Classroom Select® NeoClass® Smooth Back Chair With Casters**

The modern ribless smooth-back soft polypropylene shell features 1-1/8" 18-gauge steel legs with 2" nylon casters that are welded to the frame. Two openings at the top and bottom of the shell heighten airflow and comfort. Frame is available in chrome or black powdercoat finishes. Also offered in an A+ wider, more accommodating seat. Assembled.



Featuring the NeoClass® ribless smooth back design



Item #	Seat Height	Seat and Back Color	Frame Color	List Price
6-1496384-670	18 in A+	Specify	Chrome	\$158.95
6-1496388-670	18 in A+	Specify	Black	\$151.95
6-1496385-670	18 in	Specify	Chrome	\$151.95
6-1497910-670	18 in	Specify	Black	\$144.95
6-1496386-670	16 in	Specify	Chrome	\$144.95
6-1497909-670	16 in	Specify	Black	\$138.95
6-1496387-670	14 in	Specify	Chrome	\$140.95
6-1497908-670	14 in	Specify	Black	\$134.95



Refer to pages 60-61 for color options.



PRODUCT CERTIFIED FOR LOW CHEMICAL EMISSIONS: UL.COM/CGG UL 2818



**Classroom Select® Contemporary Chair With Casters**

This soft plastic chair offers a shell reinforced with ribs that allow greater flexibility at the upper back while still supporting the lower back. Comes standard with nylon free-rolling casters that are welded to the frame. Select A or A+ extra wide shell. Also available with 1" thick upholstered pads covered in fabric for added comfort. Assembled.

Item #	Seat Height	Seat and Back Color	Fabric Color	Frame Color	List Price
6-1388743-670	18 in A+	Specify	-	Chrome	\$146.95
6-1425583-670	18 in A+	Specify	-	Black	\$139.95
6-1388744-670	18 in	Specify	-	Chrome	\$139.95
6-1425584-670	18 in	Specify	-	Black	\$132.95
6-1496341-670	16 in	Specify	-	Chrome	\$132.95
6-1497924-670	16 in	Specify	-	Black	\$126.95
6-1496339-670	14 in	Specify	-	Chrome	\$128.95
6-1497923-670	14 in	Specify	-	Black	\$122.95

**With Seat and Back Pad**

6-1441244-670	18 in A+	Specify	Specify	Chrome	\$212.95
6-1441245-670	18 in A+	Specify	Specify	Black	\$206.95
6-1441246-670	18 in	Specify	Specify	Chrome	\$206.95
6-1441247-670	18 in	Specify	Specify	Black	\$199.95



Shown with optional seat and back pads



Shown with optional seat and back pads

**Classroom Select® Royal Seating® 1100 Chair With Casters**

The high-density polypropylene shell is connected to an 18-gauge steel frame with concealed rivets and 13-gauge steel brackets. The v-back shell is available in A and A+ shell sizes and features a comfortable waterfall edge. Includes 2" easy-rolling, hooded nylon casters that are welded to the frame. Also available with 1" thick upholstered pads for added comfort. Assembled.

Item #	Product Dimensions	Seat Height	Seat and Back Color	Fabric Color	Frame Color	List Price
6-1458235-670	20W x 21-½D x 32-½H in	18 in A+	Specify	-	Chrome	\$159.95
6-1480727-670	20W x 21-½D x 32-½H in	18 in A+	Specify	-	Black	\$152.95
6-088576-670	20W x 21-½D x 31H in	18 in	Specify	-	Chrome	\$152.95
6-1480645-670	20 W x 21-½ D x 31H in	18 in	Specify	-	Black	\$146.95

**With Seat and Back Pad**

6-1288399-670	20W x 21-½D x 32-½H in	18 in A+	Specify	Specify	Chrome	\$226.95
6-1480728-670	20W x 21-½D x 32-½H in	18 in A+	Specify	Specify	Black	\$219.95
6-1458237-670	20W x 21-½D x 31H in	18 in	Specify	Specify	Chrome	\$219.95
6-1480646-670	20 W x 21-½ D x 31H in	18 in	Specify	Specify	Black	\$212.95

**Classroom Select® Traditional Chair With Casters**

This soft plastic chair offers a shell reinforced with ribs that allow greater flexibility at the upper back while still supporting the lower back. Comes standard with nylon free-rolling casters that are welded to the frame. Available with A or A+ extra wide shell. Assembled.

Item #	Seat Height	Seat and Back Color	Frame Color	List Price
6-1388955-670	18 ½ in A+	Specify	Chrome	\$159.95
6-1425585-670	18 ½ in A+	Specify	Black	\$152.95
6-1388956-670	17-½ in	Specify	Chrome	\$152.95
6-1425586-670	17-½ in	Specify	Black	\$146.95



**Classroom Select® Royal Seating® 4100 Hard Plastic Chair With Casters**

Especially designed for science, medical, art, and computer labs, these chairs feature scratch- and acid-resistant surfaces molded from 5/8" thick, solid thermoset plastic. Sturdy 18-gauge steel frames are coated in a durable, nickel-plated chrome finish. Includes 2" easy-rolling, hooded nylon casters that are welded to the frame. Assembled.

Item #	Seat Height	Seat and Back Color	Frame Color	List Price
6-1458266-670	18 in	Specify	Chrome	\$186.95



**CLASSROOM  
SELECT**



PRODUCT CERTIFIED FOR LOW CHEMICAL EMISSIONS: UL.COM/IGG UL 2818



**PLEASE SPECIFY COLOR CHOICE**

Refer to pages 60-61 for color options.

**Classroom Select® Inspo® Pneumatic Lift Chair**

The Classroom Select® Inspo® Pneumatic Lift Chair offers updated design and comfort with a waterfall edge and ergonomic back. Opening at the top provides easy portability. Features a sturdy 5-star base that swivels 360 degrees and pneumatically adjusts in height from 17-3/4" to 22-1/4", or 14-3/8" to 16-7/8". Available in an A+ wider more accommodating seat. Casters are 2" diameter, hooded swivel casters with nylon wheels.



Featuring the NeoClass® ribless smooth back design



**Classroom Select® NeoClass® Smooth Back Pneumatic Lift Chair**

The waterfall edge and ergonomic back of the polypropylene shell promote circulation and support, while the top and bottom openings make mobility easy. The sturdy 5-star base swivels 360 degrees and pneumatically adjusts in height. Height selections include a 14-3/8" to 16-7/8" version or a 17-3/4" to 22-1/4" version which is available with A+ wider, more accommodating seat.



Item #	Seat Height	Seat and Back Color	List Price
6-5003611-670	A+ Shell 17-3/4 to 22-1/4 H in	Specify	\$226.95
6-5003610-670	A Shell 17-3/4 to 22-1/4 in	Specify	\$219.95
6-5003612-670	B Shell 14-3/8 to 16-7/8 in	Specify	\$212.95

Item #	Seat Height	Seat and Back Color	List Price
6-1496393-670	A+ Shell 17-3/4 to 22-1/4 H in	Specify	\$231.95
6-1496392-670	A Shell 17-3/4 to 22-1/4 H in	Specify	\$224.95
6-1496394-670	B Shell 14-3/8 to 16-7/8 H in	Specify	\$218.95

Item #	Description	List Price
9-1444535-670	Optional Bell Glides Set of 5	\$9.95

Item #	Description	List Price
9-1444535-670	Optional Bell Glides Set of 5	\$9.95

**Classroom Select® Contemporary Pneumatic Lift Chair**

The one-piece polypropylene shell features a tapered back opening to eliminate pressure and provide lower back support. The wide 5-star base offers stability and easy movement. The progressive waterfall seat edge promotes good circulation and relieves pressure points. Available in adjustable heights from 17-3/4" to 22-1/4" or 14-3/8" to 16-7/8". Also available in your choice of the A shell or the larger, more accommodating A+ shell size.



**Classroom Select® Traditional Pneumatic Lift Chair**

The Classroom Select® Pneumatic Lift Chair has a one-piece polypropylene shell and tapered opening in back to eliminate pressure and provide lower back support. Features a nylon star base for stability and easy movement. The progressive waterfall seat edge promotes good circulation and relieves pressure points. This chair is available in adjustable heights from 17-3/4" to 22-1/4" or 14-3/8" to 16-7/8". Also available in your choice of the A shell or the larger, more accommodating A+ shell size.



Item #	Seat Height	Seat and Back Color	Fabric Color	List Price
6-1388745-670	A+ Shell 17-3/4 to 22-1/4 H in	Specify	-	\$219.95
6-1388746-670	A Shell 17-3/4 to 22-1/4 H in	Specify	-	\$212.95
6-1441264-670	B Shell 14-3/8 to 16-7/8 H in	Specify	-	\$206.95

Item #	Seat Height	Seat and Back Color	List Price
6-1388957-670	A+ Shell 17-3/4 to 22-1/4 H in	Specify	\$219.95
6-1388958-670	A Shell 17-3/4 to 22-1/4 H in	Specify	\$212.95
6-1444528-670	B Shell 14-3/8 to 16-7/8 H in	Specify	\$206.95

**With Seat and Back Pad**

6-1441248-670	A+ Shell 17-3/4 to 22-1/4 H in	Specify	Specify	\$286.95
6-1441249-670	A Shell 17-3/4 to 22-1/4 H in	Specify	Specify	\$279.95

Item #	Description	List Price
9-1444535-670	Optional Bell Glides Set of 5	\$9.95

Item #	Description	List Price
9-1444535-670	Optional Bell Glides Set of 5	\$9.95

**Classroom Select® Royal Seating® 1100 Pneumatic Lift Chair**

Choose this cost-effective, comfortable task seating for classrooms, computer labs or offices. The one-piece, extra-large, high-density soft plastic polypropylene shell is mounted onto a 5-star base with 2" dual wheel casters. Features a 360-degree swivel, and lever that easily adjusts the height pneumatically from 17-3/4" to 22-1/4". For added comfort choose the chair with 1" thick upholstered pads covered in fabric.



**Classroom Select® Royal Seating® 4100 Hard Plastic Pneumatic Lift Chair**

Specifically designed for science, medical, art, and computer labs; these chairs are both scratch- and acid-resistant. The two-piece seat and back are constructed from 3/8" thick, solid thermoset plastic. This durable chair swivels 360 degrees and features a sturdy, 5-star base with pneumatic height adjustment. Includes easy-rolling, 2" dual wheel casters.



Item #	Seat Height	Seat and Back Color	Fabric Color	List Price
6-1458246-670	A+ 17-3/4 to 22-1/4 H in	Specify	-	\$212.95

Item #	Seat Height	Seat and Back Color	Fabric Color	List Price
6-1458247-670	A+ 17-3/4 to 22-1/4 H in	Specify	Specify	\$279.95

Item #	Seat Height	Seat and Back Color	List Price
6-1458268-670	17-3/4 to 22-1/4 H in	Specify	\$279.95

Item #	Description	List Price
9-1444535-670	Optional Bell Glides Set of 5	\$9.95

Item #	Description	List Price
9-1444535-670	Optional Bell Glides Set of 5	\$9.95





Refer to pages 60-61 for color options.



PRODUCT CERTIFIED FOR LOW CHEMICAL EMISSIONS: UL COM/CGG UL 2818



**Classroom Select® Inspo® Pneumatic Lift Stool with Adjustable Foot Ring**

The Classroom Select® Inspo® Pneumatic Lift Stool offers updated design and comfort with a waterfall seat edge and ergonomic back. Opening at the top provides easy portability. The sturdy, 5-star base has a 24" diameter, swivels 360 degrees, and features a simple turn handle to adjust the 20" foot ring. The stool pneumatically adjusts in height from 24" to 34", and is available in an A+ wider, more accommodating seat. Casters are 2" diameter, hooded swivel casters with nylon wheels.

Item #	Seat Height	Seat and Back Color	List Price
6-5003608-670	A+ Shell 24 to 34 H in	Specify	\$232.95
6-5003609-670	A Shell 24 to 34 H in	Specify	\$226.95



**Classroom Select® NeoClass® Pneumatic Lift Stool with Adjustable Foot Ring**

The waterfall edge and ergonomic back of the polypropylene shell promote circulation and support while the top and bottom openings make mobility easy. Choose from A or A+ seat size; the A+ offers a wider, more accommodating seat. The sturdy, 5-star base has a 24" diameter, swivels 360 degrees, and features durable 2" dual casters. With an adjustable pneumatic height of 24" to 34", and a simple turn handle to adjust the 20" foot ring, this chair is comfortable at any height.

Item #	Seat Height	Seat and Back Color	List Price
6-1600895-670	A+ Shell 24 to 34 H in	Specify	\$264.95
6-1598670-670	A Shell 24 to 34 H in	Specify	\$258.95

**Classroom Select® Contemporary Pneumatic Lift Stool with Adjustable Foot Ring**

This chair features a one-piece polypropylene shell with a tapered opening in back that eliminates pressure on the lower back while providing support. Choose your seat size: A or A+. The A+ offers a wider, more accommodating seat. The progressive waterfall front seat edge promotes good circulation and relieves pressure points. The sturdy, 5-star base has a 24" diameter, swivels 360 degrees, and features durable 2" dual casters. With an adjustable pneumatic height of 24" to 34", and simple turn handle to adjust the 20" foot ring this chair is comfortable at any height.

Item #	Seat Height	Seat and Back Color	List Price
6-1600892-670	A+ Shell 24 to 34 H in	Specify	\$252.95
6-1597918-670	A Shell 24 to 34 H in	Specify	\$246.95



**Classroom Select® Traditional Pneumatic Lift Stool with Adjustable Foot Ring**

This traditional task chair is the right choice for durability and mobility needs. The chair has a one-piece polypropylene shell and tapered opening in back to eliminate pressure points and provide lower back support. Choose your seat size: A or A+. The A+ offers a wider, more accommodating seat. The sturdy, 5-star base has a 24" diameter, swivels 360 degrees, and features durable 2" dual casters. With an adjustable pneumatic height of 24" to 34", and simple turn handle to adjust the 20" foot ring this chair is comfortable at any height.

Item #	Seat Height	Seat and Back Color	List Price
6-1600893-670	A+ Shell 24 to 34 H in	Specify	\$252.95
6-1598668-670	A Shell 24 to 34 H in	Specify	\$246.95

**Classroom Select® Royal Seating® Pneumatic Lift Stool with Adjustable Foot Ring**

Choose this task chair for classrooms, computer labs, and offices. The waterfall, one-piece, durable polypropylene shell offers ergonomic advantages and promotes circulation and support. Choose your seat size: A or A+. The A+ offers a wider, more accommodating seat. The sturdy, 5-star base has a 24" diameter, swivels 360 degrees, and features durable 2" dual casters. With an adjustable pneumatic height of 24" to 34", and simple turn handle to adjust the 20" foot ring this chair is comfortable at any height.

Item #	Seat Height	Seat and Back Color	List Price
6-1600894-670	A+ Shell 24 to 34 H in	Specify	\$252.95
6-1598669-670	A Shell 24 to 34 H in	Specify	\$246.95



**CLASSROOM  
SELECT**



PRODUCT CERTIFIED  
FOR LOW CHEMICAL  
EMISSIONS:  
UL.COM/IGG  
UL 2818



**PLEASE  
SPECIFY  
COLOR  
CHOICE**

Refer to pages 60-61  
for color options.



Featuring the  
NeoClass® ribless  
smooth back design



**A**



**B**



**C**



**D**

**Classroom Select® Swivel Stools**

With the Classroom Select® Swivel Stools, students and teachers have the freedom to move 360 degrees while providing excellent support as you work on your projects. Ideal for lab or art room seating. Choose from our modern smooth back polypropylene NeoClass® shell, or our Contemporary, or Traditional shells which are reinforced with ribs for extra support. The 1-1/8" 18-gauge steel tubing chrome frame features nylon glides and a comfortable foot rest which is welded to the exterior of the legs for maximum stability. Height ranges from 23-1/2" to 32-1/2". An A+ seat version with wider, more accommodating seating is also available.

Item #	Product Dimensions	Seat Height	Seat and Back Color	Fabric Color	Frame Color	List Price
<b>NeoClass® Smooth Back Swivel Stool</b>						
<b>A</b> 6-1496395-670	17W x 17-3/4D x 46-1/2H in	A+ Shell	Specify	-	Chrome	<b>\$238.95</b>
<b>A</b> 6-1496396-670	16W x 16-1/2D x 37-46H in	A Shell	Specify	-	Chrome	<b>\$231.95</b>
<b>Contemporary Swivel Stool</b>						
<b>B</b> 6-1388752-670	16W x 17D x 37-1/2-46-1/2H in	A+ Shell	Specify	-	Chrome	<b>\$226.95</b>
<b>B</b> 6-1388751-670	15W x 16D x 37-1/2-46-1/2 H in	A Shell	Specify	-	Chrome	<b>\$219.95</b>
<b>Contemporary Swivel Stool with Seat and Back Pad</b>						
<b>C</b> 6-1441250-670	16W x 17D x 37-1/2-46-1/2 H in	A+ Shell	Specify	Specify	Chrome	<b>\$292.95</b>
<b>C</b> 6-1441251-670	15W x 16D x 37-1/2-46-1/2 H in	A Shell	Specify	Specify	Chrome	<b>\$286.95</b>
<b>Traditional Swivel Stool</b>						
<b>D</b> 6-1388964-670	13W x 14D x 36 1/4-45 1/4H in	A+ Shell	Specify	-	Chrome	<b>\$226.95</b>
<b>D</b> 6-1388963-670	14W x 15D x 35-3/4-45-3/4H in	A Shell	Specify	-	Chrome	<b>\$219.95</b>

**Classroom Select® Traditional Art/Lab Stool**

Classroom Select® stools are a perfect addition to any classroom, science or technology lab. The stools feature integral chrome foot rings for extra comfort and nylon glides for easy mobility on both tile and carpet. Stool height adjusts from either 18" to 26" or 24" to 32". Seat material is available in soft or hard plastic.

Item #	Seat Height	Seat and Back Color	List Price
<b>Soft Plastic Seat</b>			
6-1388748-670	24 - 32 in	Specify	<b>\$212.95</b>
6-1388747-670	18 - 26 in	Specify	<b>\$199.95</b>
<b>Hard Plastic Seat</b>			
6-1388750-670	24 - 32 in	Specify	<b>\$219.95</b>
6-1388749-670	18 - 26 in	Specify	<b>\$206.95</b>



**Classroom Select® Pneumatic Stool**

The Classroom Select® Pneumatic Stool is a great, cost-effective option for any environment, especially in ones where space is limited. This 360-degree swivel stool features a 16" round seat cushion, in an easy to clean vinyl fabric. A durable chrome finish pneumatic lift base offers height adjustments from 17" to 22-1/2". This stool features 2" dual-wheel casters perfect for any floor surface.

Item #	Seat Height	Fabric Color	Frame Color	List Price
6-2051242-670	17 - 22-1/2 in	Black	Chrome	<b>\$199.95</b>



Refer to pages 60-61 for color options.



PRODUCT CERTIFIED FOR LOW CHEMICAL EMISSIONS: UL.COM/GG UL 2818



Featuring a smooth back design

### Classroom Select® Inspo® Bistro Stool

The Classroom Select® Inspo® Bistro Stool offers comfort and an updated design. The waterfall seat edge and contoured back bring ergonomic comfort. The sleek 3/4" round tube frame in a durable 15-gauge steel offers strength and stability. Frame colors available in chrome, black, or titanium powdercoat frame options. Height selections include 24" or 30" in your choice of the A shell or the larger, more accommodating A+ shell size. Features a foot rest for comfortable seating positions. Available in your choice of nylon, steel, felt, or rubber glides. Assembled.



Item #	Seat Height	Seat and Back Color	Frame Color	Glide/Caster Type	List Price
<b>A+ Shell</b>					
6-5003801-670	30 in	Specify	Chrome	Specify	\$199.95
6-5003798-670	30 in	Specify	Specify	Specify	\$192.95
6-5003802-670	24 in	Specify	Chrome	Specify	\$192.95
6-5003799-670	24 in	Specify	Specify	Specify	\$186.95
<b>A Shell</b>					
6-5003797-670	30 in	Specify	Chrome	Specify	\$192.95
6-5003803-670	30 in	Specify	Specify	Specify	\$186.95
6-5003804-670	24 in	Specify	Chrome	Specify	\$186.95
6-5003800-670	24 in	Specify	Specify	Specify	\$179.95



Featuring the NeoClass® ribless smooth back design



### Classroom Select® NeoClass® Bistro Stool

The Classroom Select® NeoClass® Bistro Stool offers a waterfall seat edge and a contoured back with an opening at the top and bottom to provide ergonomic comfort and boost airflow. Available in an A shell size as well as the wider, more accommodating A+ shell size. Offered in 24" and 30" seat heights and features a foot rest for comfortable seating positions. Frame is made of 1" diameter 16-gauge steel and is available in chrome, black powdercoat, and titanium powdercoat. Nylon glides. Assembled.

Item #	Seat Height	Seat and Back Color	Frame Color	List Price
<b>A+ Shell</b>				
6-5002985-670	30 in	Specify	Chrome	\$184.95
6-5002987-670	30 in	Specify	Specify	\$178.95
6-5003607-670	24 in	Specify	Chrome	\$178.95
6-5003606-670	24 in	Specify	Specify	\$171.95
<b>A Shell</b>				
6-5002986-670	30 in	Specify	Chrome	\$178.95
6-5002988-670	30 in	Specify	Specify	\$171.95
6-5003605-670	24 in	Specify	Chrome	\$171.95
6-5003604-670	24 in	Specify	Specify	\$164.95

### Classroom Select® NeoClass® Sled Base Stacking Chair and Bistro Chair

The Sled Base Stacking Chair and Bistro Chair can be used in a multitude of settings. Choose from a standard 18" seat height or 30" bistro height option. The polypropylene molded seat and back provide optimal comfort and support. A convenient hand hold offers easy movement and stacking. Chrome steel frame is durable and lightweight. Rounded polyethylene glides will protect the floor. The standard sled based stacking chair glide can be used for ganging purposes. To make transporting even easier for the 18" chair only, try the Classroom Select® chair dolly, sold separately. Glides are removable for carpet use. Assembled.

Item #	Seat Height	Seat and Back Color	Frame Color	List Price
6-1597928-670	30 in	Specify	Chrome	\$151.95
6-1597927-670	18 in	Specify	Chrome	\$124.95

Item #	Description	List Price
6-2024418-670	Chair Dolly	\$266.95



Stacking Chair pairs with our new SimpleStack® Stackable Desks. See page 35 for more information.







# CLASSROOM SELECT® CHAIR COMPARISON CHART

Use this chart to compare our top-selling chairs to find the right product for your needs.



**INSPO®**  
P. 15, 21, 26, 28, 29, 31



**NEOCLASS®**  
P. 16, 22, 24, 26, 28, 29, 30, 31



**CONTEMPORARY**  
P. 17, 20, 23, 24, 27, 28, 29, 30



**TRADITIONAL**  
P. 18, 25, 27, 28, 29, 30



**ROYAL SERIES®**  
P. 19, 20, 25, 27, 28, 29

Shell Material	Polypropylene	Polypropylene	Polypropylene	Polypropylene	Polypropylene	
Shell Features	Back Design Style	Smooth (Easy Maintenance)	Smooth (Easy Maintenance)	Rib (Greater Flexibility)	Rib (Greater Flexibility)	
	Integrated Handles	1	2	1	1	
	Quantity of Available Shell Colors	22	22	10	10	
	Seat Style	Waterfall Seat Edge	Waterfall Seat Edge	Waterfall Seat Edge	Waterfall Seat Edge	Waterfall Seat Edge
Frame Type and Shell Chair Sizes (A+, A, B, C)	Round 4 Leg Chair with Glides or Casters	20-12" Four Leg - Shell/Chair Height Sizes: A+/20", A+/18", A/18", B/16", C/14", C/12" 20-14" Four Leg with Casters - Shell/Chair Height Sizes: A+/20", A+/18", A/18", B/16", C/14"	20-12" Four Leg - Shell/Chair Height Sizes: A+/20", A+/18", A/18", B/16", C/14", C/12" 18-14" Four Leg with Casters - Shell/Chair Height Sizes: A+/18", A/18", B/16", C/14"	20-8" Four Leg - Shell/Chair Height Sizes: A+/20", A+/18", A/18", B/16", C/14", C/12", C/10", C/8" - Fabric Seat and Back Pads available on the A+/20", A+/18", A/18", 18-14" Four Leg with Casters - Shell/Chair Height Sizes: A+/18", A/18", B/16", C/14"	20 ½-11 ½" Four Leg - Shell/Chair Height Sizes: A+/20 ½", A+/18" ½, A/17 ½", B/15 ½", C/13 ½", C/11 ½"	18-8" Four Leg - Shell/Chair Height Sizes: A+/18", A/18", B/16", C/14", C/12", C/10", C/8"
	Elliptical 4 Leg Chair with Glides or Casters	20-12" Elliptical Four Leg - Shell/Chair Height Sizes: A+/20", A+/18", A/18", B/16", C/14", C/12" 20-14" Elliptical Four Leg with Casters - Shell/Chair Height Sizes: A+/20", A+/18", A/18", B/16", C/14"	20-12" Elliptical Four Leg - Shell/Chair Height Sizes: A+/20", A+/18", A/18", B/16", C/14", C/12"	-	-	-
	Elliptical Cantilever Leg Chair	20-14" Elliptical Cantilever Leg - Shell/Chair Height Sizes: A+/20", A+/18", A/18", B/16", C/14"	20-14" Elliptical Cantilever Leg - Shell/Chair Height Sizes: A+/20", A+/18", A/18", B/16", C/14"	-	-	-
	Round Cantilever Leg Chair	20-12" Round Cantilever - Shell/Chair Height Sizes: A+/20", A+/18", A/18", B/16", C/14", C/12"	20-12" Round Cantilever - Shell/Chair Height Sizes: A+/20", A+/18", A/18", B/16", C/14", C/12"	20-14" Round Cantilever - Shell/Chair Height Sizes: A+/20", A+/18", A/18", B/16", C/14"	-	-
	Sled Base Chair	-	20-14" Sled Base - Shell/Chair Height Sizes: A+/20", A+/18", A/18", B/16", C/14"	20-14" Sled Base - Shell/Chair Height Sizes: A+/20", A+/18", A/18", B/16", C/14" - Fabric Seat and Back Pads available on the A+/20", A+/18", A/18"	20 ½-13 ½" Sled Base - Shell/Chair Height Sizes: A+/20 ½", A+/18" ½, A/17 ½", B/15 ½", C/13 ½"	18-14" Sled Base - Shell/Chair Height Sizes: A+/18", A/18", B/16", C/14"
	Pneumatic Chair	Height Adjustable - Shell/Chair Height Sizes: A+/17 ¾-22 ¼", A/17 ¾-22 ¼", B/14 ¾-16 ⅞"	Height Adjustable - Shell/Chair Height Sizes: A+/17 ¾-22 ¼", A/17 ¾-22 ¼", B/14 ¾-16 ⅞"	Height Adjustable - Shell/Chair Height Sizes: A+/17 ¾-22 ¼", A/17 ¾-22 ¼", B/14 ¾-16 ⅞"	Height Adjustable - Shell/Chair Height Sizes: A+/17 ¾-22 ¼"	Height Adjustable - Shell/Chair Height Sizes: A+/17 ¾-22 ¼", A/17 ¾-22 ¼", B/14 ¾-16 ⅞"
	Pneumatic Stool with Foot Ring	Height Adjustable - Shell/Chair Height Sizes: A+/24-34", A/24-34"	Height Adjustable - Shell/Chair Height Sizes: A+/24-34", A/24-34"	Height Adjustable - Shell/Chair Height Sizes: A+/24-34", A/24-34"	Height Adjustable - Shell/Chair Height Sizes: A+/24-34", A/24-34"	Height Adjustable - Shell/Chair Height Sizes: A+/24-34", A/24-34"
	Swivel Stool	-	Height Adjustable - Shell/Chair Height Sizes: A+/23 ½-32 ½", A/23 ½-32 ½"	Height Adjustable - Shell/Chair Height Sizes: A+/23 ½-32 ½", A/23 ½-32 ½"	Height Adjustable - Shell/Chair Height Sizes: A+/23 ½-32 ½", A/23 ½-32 ½"	-
	Bistro Stool	Shell/Chair Height Sizes: A+/30", A+/24", A/30", A/24"	Shell/Chair Height Sizes: A+/30", A+/24", A/30", A/24"	-	-	-
	Frame Color	Chrome, Black, Titanium	Chrome, Black, Titanium	Chrome, Black, Matching Seat & Frame	Chrome, Black	Chrome, Black, Matching Seat & Frame
Glide Options	Steel, Nylon, Felt, Rubber	Steel, Nylon, Felt, Rubber	Steel, Nylon, Felt, Rubber	Steel, Nylon, Felt, Rubber	Steel, Nylon, Felt, Rubber	
Stackable (4-Leg Frame)	8 High	4 High	4 High	10 High	10 High	

Contact your School Specialty rep to discuss custom options.



**National Public Seating® Elephant Z-Stool**

The Elephant Z-Stool provides the perfect solution for the most demanding lab and art environments. Features a chrome-plated, 14-gauge tubular steel frame, and a lightweight, blow-molded seat that is contoured to fit the user. Stools are conveniently stackable (six units high) or hang with ease from tabletop surfaces, allowing for simple clean-up and storage. 22" and 24" stools include foot rests.

Item #	Seat Height	List Price
<b>Without Backrest</b>		
6-1366664-670	24 in	\$193.95
6-1366663-670	22 in	\$185.95
6-1366662-670	18 in	\$177.95
<b>With Backrest</b>		
6-1366667-670	24 in	\$246.95
6-1366666-670	22 in	\$239.95
6-1366665-670	18 in	\$233.95



**National Public Seating® Kangaroo Stool**

Kangaroo Stool provides unique strength and function for your industrial seating demands, yet designed with beauty and grace in mind. This model includes the addition of arms, which enhances the stool, offering added support and comfort. Heavy duty 1-1/4 inch thick Polyurethane seat has a waterfall edge for plush comfort and functionality, and ribbed ventilation design allows air circulation while seated. Polyurethane material is resistant to chemicals and punctures, and cleans easily.

Item #	Description	Product Dimensions	Color	List Price
5-2103799-670	Short w/Arms Stool	26 W x 26 D x 27 - 37 H in	Black	\$499.95
5-2103798-670	Short Armless Stool	26 W x 26 D x 27 - 37 H in	Black	\$397.95
5-2103801-670	Tall w/Arms Stool	26 W x 26 D x 38 - 48 H in	Black	\$540.95
6-1543396-670	Tall Armless Stool	26 W x 26 D x 38 - 48 H in	Black	\$450.95





**National Public Seating® Heavy Duty Steel Stools**

Stools feature a 14"-diameter seat with hardboard inset attached with 8 rivets onto a 20-gauge steel seat pan. Each 18-gauge 7/8"-diameter leg is welded to a 5/8" foot ring with 4 spot weld contact points. Non-marring plastic glides standard on fixed-height stools, self-leveling glides standard on adjustable-height stools. Backs adjust 2" up/down and 2" forward/back.

Item #	Seat Height	Frame Color	List Price
<b>Fixed Height</b>			
6-600255-670	18 in	Gray	\$73.95
6-1451847-670	18 in	Black	\$73.95
6-217054-670	24 in	Gray	\$77.95
6-1451848-670	24 in	Black	\$77.95
6-217063-670	30 in	Gray	\$94.95
6-2104010-670	30 in	Black	\$94.95
<b>Fixed Height with Backrest</b>			
6-622281-670	18 in	Gray	\$112.95
6-1503855-670	18 in	Black	\$112.95
6-622284-670	24 in	Gray	\$116.95
6-1503858-670	24 in	Black	\$116.95
6-622287-670	30 in	Gray	\$132.95
6-2104018-670	30 in	Black	\$132.95
<b>Adjustable Height</b>			
6-622272-670	19-27 in	Gray	\$99.95
6-1451849-670	19-27 in	Black	\$99.95
6-622275-670	25-33 in	Gray	\$104.95
6-1451850-670	25-33 in	Black	\$104.95
6-622278-670	31-39 in	Gray	\$120.95
6-2104019-670	30-1/2 -38-1/2 in	Black	\$120.95
<b>Adjustable Height with Backrest</b>			
6-217072-670	19-27 in	Gray	\$138.95
6-1503856-670	19-27 in	Black	\$138.95
6-673201-670	25-33 in	Gray	\$142.95
6-1503857-670	25-33 in	Black	\$142.95
6-673202-670	31-39 in	Gray	\$158.95
6-2104028-670	30-1/2 -38-1/2 in	Black	\$158.95



Fixed Height Stools with Gray Frame



Adjustable Height Stools with Black Frame



Fixed Height

Adjustable Height

**National Public Seating® Heavy Duty Vinyl Padded Steel Stools**

This reliable stool features a strong frame of 18-gauge steel tubing securedly welded to a 14" diameter seat pan. Riveted through the steel pan are 1/2" thick vinyl cushioning that will provide years of dependable use. Footrest ring is securely bonded to each leg with four-spot-weld contact points. Optional vinyl padded backrest can be adjusted two inches up/down and forward/back.

Item #	Seat Height	Frame Color	List Price
<b>Fixed Height</b>			
6-1273552-670	18 in	Gray	\$82.95
6-1584451-670	18 in	Black	\$82.95
6-1373064-670	24 in	Gray	\$89.95
6-1584452-670	24 in	Black	\$89.95
6-1318412-670	30 in	Gray	\$105.95
6-2104039-670	30 in	Black	\$105.95
<b>Fixed Height with Backrest</b>			
6-1373063-670	18 in	Gray	\$126.95
6-1584455-670	18 in	Black	\$126.95
6-528567-670	24 in	Gray	\$134.95
6-1584456-670	24 in	Black	\$134.95
6-528568-670	30 in	Gray	\$150.95
6-2104057-670	30 in	Black	\$150.95
<b>Adjustable Height</b>			
6-1289229-670	19-27 in	Gray	\$108.95
6-1584453-670	19-27 in	Black	\$108.95
6-1409374-670	25-33 in	Gray	\$115.95
6-1584454-670	25-33 in	Black	\$115.95
6-1373065-670	31-39 in	Gray	\$131.95
6-2104058-670	30-1/2 -38-1/2 in	Black	\$131.95
<b>Adjustable Height with Backrest</b>			
6-677134-670	19-27 in	Gray	\$153.95
6-1584457-670	19-27 in	Black	\$153.95
6-677135-670	25-33 in	Gray	\$160.95
6-1584458-670	25-33 in	Black	\$160.95
6-677136-670	31-39 in	Gray	\$176.95
6-2104060-670	30-1/2 -38-1/2 in	Black	\$176.95



## CLASSROOM SELECT



PRODUCT CERTIFIED FOR LOW CHEMICAL EMISSIONS: UL COM/CGG UL 2818



PLEASE SPECIFY COLOR CHOICE

Refer to pages 60-61 for color options.

### Classroom Select® SimpleStack®

The SimpleStack® desk pairs perfectly with our Classroom Select® NeoClass® Sled Base Stacking Chair. Like the stacking chair, these desks can be used in a multitude of settings. Choose from 2 neutral gray panel color options, Slate or Nickel, that coordinate with your choice of any of our 22 polypropylene colors. We also offer a no modesty panel version. The lightly textured polypropylene molded top helps prevent scratches and is durable enough to withstand any classroom environment. Chrome steel frame is durable and lightweight. Available in your choice of nylon, steel, felt or rubber glides, which are also removable for easy transition on carpeted surfaces. Make transporting a breeze with the Classroom Select® SimpleStack® dolly, sold separately. Assembled.



Pairs with our Sled Base Stacking Chair. See Page 1310



SimpleStack® Desks with Modesty Panel



SimpleStack® Desk Without Modesty Panel



Desk Dolly

Product Dimensions	Top Type	Frame Color	Top Color	Glide/Caster Type	With Modesty Panel			Without Modesty Panel		Item#	List Price
					Item #	Modesty Panel Color	List Price	Item #	List Price		
<b>Standard Frame</b>											
29 W x 25 D x 28 H in	Polypropylene	Chrome	Specify	Specify	6-5004123-670	Specify	\$252.95	6-5004687-670	\$239.95	6-2041276-670	\$332.95
<b>ADA Frame</b>											
33 W x 25 D x 28 H in	Polypropylene	Chrome	Specify	Specify	6-5004125-670	Specify	\$259.95	6-5004688-670	\$246.95		

### Classroom Select® NeoMove2® Chair

Our NeoMove2® chair's dynamic mobility and range of motion allow for quick transitioning from learning groups to lecture-based learning. The polypropylene seat swivels 360 degrees and offers a waterfall edge reducing pressure points and enhancing ergonomic comfort. The unique tablet arm has swivel capability to accommodate left and right-handed students with interval indexing movement to hold designated positions selected as the student moves the arm. Durable non-locking casters offer smooth movement and rotation. Generously sized 26" x 14" tablet top features a pencil holder. The titanium steel base design allows for easy open access to a generous bottom storage area and is accessorized with a water bottle holder. Available in a polypropylene over metal base. Assembled.



Seat Height	Seat and Back Color					Poly Covered Base		
Chair without Tablet Arm						Item #	List Price	
18 in A+	Specify					6-1612911-670	\$392.95	
18 in A	Specify					6-5000924-670	\$386.95	

Seat Height	Top Type	Edge Type	Seat and Back Color	Edge Color	Poly Covered Base			
Chair with Tablet Arm						Item #	Top Color	List Price
18 in A+	<b>NEW</b> Laminate	Painted	Specify	Specify	6-1612912-670	Specify	\$591.95	
18 in A+	Plastic	-	Specify	-	6-1612914-670	Titanium	\$591.95	
18 in A+	Laminate	LockEdge	Specify	Specify	6-1612913-670	Specify	\$624.95	
18 in A	<b>NEW</b> Laminate	Painted	Specify	Specify	6-5000925-670	Specify	\$584.95	
18 in A	Plastic	-	Specify	-	6-5000927-670	Titanium	\$584.95	
18 in A	Laminate	LockEdge	Specify	Specify	6-5000926-670	Specify	\$618.95	

### Classroom Select® Inspo® Stacking Study Top A+ Desk

The Classroom Select® Inspo® Stack Desk features a unique shape design that pairs nicely with the Inspo® chair series and convenient stacking. The round 1-1/4" titanium frame features a height adjustable range of 22-1/2" to 31-1/2", with 2 locking casters and 2 nylon glides that allow for easy mobility, whether stacked or individually. Available with a generously sized 26" x 16", 5/8" thick desk top, with a high pressure laminate or markerboard surface, with your choice of a beige or titanium painted edge, 5 T-Mold colors, or 5 LockEdge® colors. The standard backpack hook keeps backpacks off the floor.



Product Dimensions	Frame Color	Edge Type	Edge Color	Glide/Caster Type	Laminate Top			Markerboard Top	
					Item #	Top Color	List Price	Item #	List Price
26 W x 20 D in	Titanium	Painted	Specify	4 Nylon Glides	6-5009558-670	Specify	\$352.95	6-5009561-670	\$366.95
26 W x 20 D in	Titanium	T-Mold	Specify	4 Nylon Glides	6-5009556-670	Specify	\$339.95	6-5009559-670	\$352.95
26 W x 20 D in	Titanium	LockEdge	Specify	4 Nylon Glides	6-5009557-670	Specify	\$406.95	6-5009560-670	\$419.95
26 W x 20 D in	Titanium	Painted	Specify	2 Casters 2 Glides	6-5009546-670	Specify	\$359.95	6-5009549-670	\$372.95
26 W x 20 D in	Titanium	T-Mold	Specify	2 Casters 2 Glides	6-5009544-670	Specify	\$346.95	6-5009547-670	\$359.95
26 W x 20 D in	Titanium	LockEdge	Specify	2 Casters 2 Glides	6-5009545-670	Specify	\$412.95	6-5009548-670	\$426.95

**CLASSROOM  
SELECT**



PRODUCT CERTIFIED  
FOR LOW CHEMICAL  
EMISSIONS:  
UL.COM/CGG  
UL 2918



PLEASE  
SPECIFY  
COLOR  
CHOICE

Refer to page 60-61  
for color options.



Featuring the NeoClass®  
ribless smooth back design

**Classroom Select® NeoClass® Smooth Back Four Leg Combination Desk**

Contemporary look and comfort are key elements to this polypropylene smooth-back chair mated to a generous desktop work surface and a 1-1/8", 12-gauge tubular frame. A waterfall edge and contoured back with openings at the top and bottom enhances ergonomic comfort and boosts airflow. Desks available in 18" x 24" or 20" x 26" hard plastic or high pressure laminate; laminate tops come with your choice of colored LockEdge®, T-Mold edge, or painted edge in beige or titanium. Frame comes in chrome or black powdercoat, 18" seat height, and additional A+ shell option that offers a wider seat shell. Optional field installed book baskets available. Assembled.

**Please order in carton quantities of two.**

Top Type	Seat Height	Edge Type	Frame Color	Seat and Back Color	Top Color	Edge Color	18 x 24 in Top Size		20 x 26 in Top Size	
							Item #	List Price	Item #	List Price
Laminate	18 in A+	Painted	Chrome	Specify	Specify	Specify	6-1496610-670	\$286.95	6-1496622-670	\$299.95
Laminate	18 in A+	Painted	Black	Specify	Specify	Specify	6-1497918-670	\$272.95	6-1497921-670	\$286.95
Laminate <b>NEW</b>	18 in A+	T-Mold	Chrome	Specify	Specify	Specify	6-5009325-670	\$286.95	6-5009312-670	\$299.95
Laminate <b>NEW</b>	18 in A+	T-Mold	Black	Specify	Specify	Specify	6-5009310-670	\$272.95	6-5009335-670	\$286.95
Hard Plastic	18 in A+	-	Chrome	Specify	Specify	-	6-1496614-670	\$312.95	6-1496626-670	\$326.95
Hard Plastic	18 in A+	-	Black	Specify	Specify	-	6-1497919-670	\$299.95	6-1497922-670	\$312.95
Laminate	18 in A+	LockEdge	Chrome	Specify	Specify	Specify	6-1496612-670	\$319.95	6-1496624-670	\$332.95
Laminate	18 in A+	LockEdge	Black	Specify	Specify	Specify	6-1497917-670	\$306.95	6-1497920-670	\$319.95
Laminate	18 in	Painted	Chrome	Specify	Specify	Specify	6-1496616-670	\$279.95	6-1496628-670	\$292.95
Laminate	18 in	Painted	Black	Specify	Specify	Specify	6-1497912-670	\$266.95	6-1497915-670	\$279.95
Laminate <b>NEW</b>	18 in	T-Mold	Chrome	Specify	Specify	Specify	6-5009329-670	\$279.95	6-5009314-670	\$292.95
Laminate <b>NEW</b>	18 in	T-Mold	Black	Specify	Specify	Specify	6-5009334-670	\$266.95	6-5009330-670	\$279.95
Hard Plastic	18 in	-	Chrome	Specify	Specify	-	6-1496620-670	\$306.95	6-1496632-670	\$319.95
Hard Plastic	18 in	-	Black	Specify	Specify	-	6-1497913-670	\$292.95	6-1497916-670	\$306.95
Laminate	18 in	LockEdge	Chrome	Specify	Specify	Specify	6-1496618-670	\$312.95	6-1496630-670	\$326.95
Laminate	18 in	LockEdge	Black	Specify	Specify	Specify	6-1497911-670	\$299.95	6-1497914-670	\$312.95

Item #	Description	List Price
9-1362136-670	Chrome Wire Book Basket	\$22.95
9-1441266-670	Black Wire Book Basket	\$22.95

**Classroom Select® Contemporary Four Leg Combination Desk**

Enjoy your desk and chair convenience with this unique classroom furniture product. Using the same seat as our Contemporary Series chair, this desk offers a 18" x 24" or 20" x 26" hard plastic or high pressure laminate; laminate tops come with your choice of colored LockEdge®, T-Mold edge, or painted edge in beige or titanium. Choose between a chrome or black powdercoat frame. Available in your choice of the A shell or the larger, more accommodating A+ shell size. Optional field installed book baskets available. Assembled. **Please order in carton quantities of two.**



Top Type	Seat Height	Edge Type	Frame Color	Seat and Back Color	Top Color	Edge Color	18 x 24 in Top Size		20 x 26 in Top Size	
							Item #	List Price	Item #	List Price
Laminate	18 in A+	Painted	Chrome	Specify	Specify	Specify	6-1441220-670	\$259.95	6-1444518-670	\$272.95
Laminate	18 in A+	Painted	Black	Specify	Specify	Specify	6-1441222-670	\$246.95	6-1444520-670	\$259.95
Laminate <b>NEW</b>	18 in A+	T-Mold	Chrome	Specify	Specify	Specify	6-5009333-670	\$259.95	6-5009331-670	\$272.95
Laminate <b>NEW</b>	18 in A+	T-Mold	Black	Specify	Specify	Specify	6-5009328-670	\$246.95	6-5009316-670	\$259.95
Hard Plastic	18 in A+	-	Chrome	Specify	Specify	-	6-1441224-670	\$286.95	6-1444522-670	\$299.95
Hard Plastic	18 in A+	-	Black	Specify	Specify	-	6-1441225-670	\$272.95	6-1444523-670	\$286.95
Laminate	18 in A+	LockEdge	Chrome	Specify	Specify	Specify	6-1441221-670	\$292.95	6-1444519-670	\$306.95
Laminate	18 in A+	LockEdge	Black	Specify	Specify	Specify	6-1441223-670	\$279.95	6-1444521-670	\$292.95
Laminate	18 in	Painted	Chrome	Specify	Specify	Specify	6-1357328-670	\$252.95	6-1441886-670	\$266.95
Laminate	18 in	Painted	Black	Specify	Specify	Specify	6-1395303-670	\$239.95	6-1441887-670	\$252.95
Laminate <b>NEW</b>	18 in	T-Mold	Chrome	Specify	Specify	Specify	6-5009313-670	\$252.95	6-5009322-670	\$266.95
Laminate <b>NEW</b>	18 in	T-Mold	Black	Specify	Specify	Specify	6-5009317-670	\$239.95	6-5009324-670	\$252.95
Hard Plastic	18 in	-	Chrome	Specify	Specify	-	6-1388735-670	\$279.95	6-1441890-670	\$292.95
Hard Plastic	18 in	-	Black	Specify	Specify	-	6-1395304-670	\$266.95	6-1441891-670	\$279.95
Laminate	18 in	LockEdge	Chrome	Specify	Specify	Specify	6-1426977-670	\$286.95	6-1441888-670	\$299.95
Laminate	18 in	LockEdge	Black	Specify	Specify	Specify	6-1426978-670	\$272.95	6-1441889-670	\$286.95

Item #	Description	List Price
9-1362136-670	Chrome Wire Book Basket	\$22.95
9-1441266-670	Black Wire Book Basket	\$22.95



**CLASSROOM  
SELECT** 



PRODUCT CERTIFIED  
FOR LOW CHEMICAL  
EMISSIONS:  
UL.COM/IGG  
UL 2818



**PLEASE  
SPECIFY  
COLOR  
CHOICE**

Refer to pages 60-61  
for color options.



Optional Chrome Wire  
Book Rack

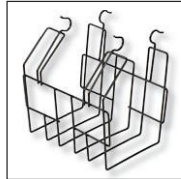

Optional Black Wire  
Book Basket



**Classroom Select® Royal Seating® 1400 Four Leg Combination Desk**

The Royal Seating® 1400 combination desk features the Royal Seating® 1100 chair shell with an 24" x 18" or 26" x 20" top on a 1-1/2" chrome plated or black powder coat tubular steel frame. Desktops available in either hard plastic or high pressure laminate; laminate tops come with your choice of colored LockEdge®, T-Mold edge, or painted edge in beige or titanium. An optional field installed wire book basket is sold separately. Assembled. Please order in carton quantities of two.

Top Type	Seat Height	Edge Type	Frame Color	Seat and Back Color	Top Color	Edge Color	18 x 24 in Top Size		20 x 26 in Top Size	
							Item #	List Price	Item #	List Price
Laminate	18 in	Painted	Chrome	Specify	Specify	Specify	6-5009931-670	\$246.95	6-5009933-670	\$259.95
Laminate	18 in	Painted	Black	Specify	Specify	Specify	6-5009930-670	\$232.95	6-5009932-670	\$246.95
Laminate	18 in	T-Mold	Chrome	Specify	Specify	Specify	6-1458248-670	\$246.95	6-1496591-670	\$259.95
Laminate	18 in	T-Mold	Black	Specify	Specify	Specify	6-1486875-670	\$232.95	6-1497926-670	\$246.95
Hard Plastic	18 in	-	Chrome	Specify	Specify	-	6-1458252-670	\$272.95	6-1496592-670	\$286.95
Hard Plastic	18 in	-	Black	Specify	Specify	-	6-1486876-670	\$259.95	6-1497928-670	\$272.95
Laminate	18 in	LockEdge	Chrome	Specify	Specify	Specify	6-1496590-670	\$279.95	6-1496593-670	\$292.95
Laminate	18 in	LockEdge	Black	Specify	Specify	Specify	6-1497925-670	\$266.95	6-1497927-670	\$279.95

Item #	Description	List Price
9-1362135-670	Chrome Wire Book Basket	\$24.95
9-1441265-670	Black Wire Book Basket	\$24.95



Hard Plastic Top



Laminate Top

**Classroom Select® Royal Seating® 4400 Combination Desks**

The 4400 combination desk offers heavy duty thermoset plastic seats, backs, and tops that are scratch resistant, and easy to clean. The standard features include a 5/8" top with a chrome or black frame and nylon glides. Choose between an 18" x 24" high pressure laminate top with a T-Mold, an 18" x 24" painted edge in beige or titanium, or an 18" x 24" hard plastic top. An optional field installed wire book basket is sold separately. Assembled.

Item #	Top Size	Top Type	Edge Type	Frame Color	Seat and Back Color	Top Color	Edge Color	List Price
6-5009929-670		Laminate	Painted	Chrome	Specify	Specify	Specify	\$306.95
6-5009928-670		Laminate	Painted	Black	Specify	Specify	Specify	\$292.95
6-1458271-670	18 x 24 in	Laminate	T-Mold	Chrome	Specify	Specify	Specify	\$306.95
6-1487017-670	18 x 24 in	Laminate	T-Mold	Black	Specify	Specify	Specify	\$292.95
6-1458269-670	18 x 24 in	Hard Plastic	-	Chrome	Specify	Specify	Specify	\$326.95
6-1487016-670	18 x 24 in	Hard Plastic	-	Black	Specify	Specify	Specify	\$312.95

Item #	Description	List Price
9-1362135-670	Chrome Wire Book Basket	\$24.95
9-1441265-670	Black Wire Book Basket	\$24.95





PRODUCT CERTIFIED FOR LOW CHEMICAL EMISSIONS: UL.COM/IGG UL 2818



**PLEASE SPECIFY COLOR CHOICE**

Refer to pages 60-61 for color options.



Shown with Optional Book Basket

**Classroom Select® Traditional Four Leg Combination Desk**

Using the same seat as our Traditional Series chair, this desk offers an 18" x 24" or 20" x 26" top available in either hard plastic or high pressure laminate; laminate tops come with your choice of colored LockEdge®, T-Mold edge, or painted edge in beige or titanium. An optional field installed wire book basket is sold separately. Available in your choice of the A shell or the larger, more accommodating A+ shell size. Assembled. **Please order in carton quantities of two.**

Top Type	Seat Height	Edge Type	Frame Color	Seat and Back Color	Top Color	Edge Color	18 x 24 in Top Size		20 x 26 in Top Size	
							Item #	List Price	Item #	List Price
Laminate	18-1/2 in A+	Painted	Chrome	Specify	Specify	Specify	6-1441226-670	\$252.95	6-1444510-670	\$266.95
Laminate	18-1/2 in A+	Painted	Black	Specify	Specify	Specify	6-1441228-670	\$239.95	6-1444512-670	\$252.95
Laminate	18-1/2 in A+	T-Mold	Chrome	Specify	Specify	Specify	6-5009320-670	\$252.95	6-5009319-670	\$266.95
Laminate	18-1/2 in A+	T-Mold	Black	Specify	Specify	Specify	6-5009321-670	\$239.95	6-5009309-670	\$252.95
Hard Plastic	18-1/2 in A+	—	Chrome	Specify	Specify	—	6-1441230-670	\$279.95	6-1444514-670	\$292.95
Hard Plastic	18-1/2 in A+	—	Black	Specify	Specify	—	6-1441231-670	\$266.95	6-1444515-670	\$279.95
Laminate	18-1/2 in A+	LockEdge	Chrome	Specify	Specify	Specify	6-1441227-670	\$286.95	6-1444511-670	\$299.95
Laminate	18-1/2 in A+	LockEdge	Black	Specify	Specify	Specify	6-1441229-670	\$272.95	6-1444513-670	\$286.95
Laminate	17-1/2 in	Painted	Chrome	Specify	Specify	Specify	6-1357321-670	\$246.95	6-1441877-670	\$259.95
Laminate	17-1/2 in	Painted	Black	Specify	Specify	Specify	6-1415402-670	\$232.95	6-1441878-670	\$246.95
Laminate	17-1/2 in	T-Mold	Chrome	Specify	Specify	Specify	6-5009311-670	\$246.95	6-5009308-670	\$259.95
Laminate	17-1/2 in	T-Mold	Black	Specify	Specify	Specify	6-5009332-670	\$232.95	6-5009326-670	\$246.95
Hard Plastic	17-1/2 in	—	Chrome	Specify	Specify	—	6-1388953-670	\$272.95	6-1441879-670	\$286.95
Hard Plastic	17-1/2 in	—	Black	Specify	Specify	—	6-1415403-670	\$259.95	6-1441880-670	\$272.95
Laminate	17-1/2 in	LockEdge	Chrome	Specify	Specify	Specify	6-1426980-670	\$279.95	6-1441881-670	\$292.95
Laminate	17-1/2 in	LockEdge	Black	Specify	Specify	Specify	6-1426981-670	\$266.95	6-1441882-670	\$279.95

Item #	Description	List Price
9-1362135-670	Chrome Wire Book Basket	\$24.95
9-1441265-670	Black Wire Book Basket	\$24.95



Refer to pages 60-61 for color options.



PRODUCT CERTIFIED FOR LOW CHEMICAL EMISSIONS: UL 2818 GREENGUARD GOLD



### Classroom Select® NeoClass® Smooth Back Sled Base Combination Desk

Some environments require stability and flexibility while still providing an ample work surface. That's where this fresh, static-free polypropylene chair shell with a generous desktop and 1-1/8", 12-gauge tubular frame comes in. The waterfall seat edge and contoured back can support the user while still flexing from side to side. Openings at the top and bottom of the shell boost airflow, further enhancing comfort and boosting focus while also making the desk easy to transport. Desktops available in 18" x 24" or 20" x 26" hard plastic or high pressure laminate; laminate tops come with your choice of colored LockEdge®, T-Mold edge, or painted edge in beige or titanium. 18" seat height, and additional A+ shell option offer a wider seat shell. Sled base frame is available in chrome or a black powder coat with optional felt glides. Assembled. **Please order in carton quantities of two.**

Top Type	Seat Height	Edge Type	Frame Color	Seat and Back Color	Top Color	Edge Color	18 x 24 in Top Size		20 x 26 in Top Size	
							Item #	List Price	Item #	List Price
Laminate	18 in A+	Painted	Chrome	Specify	Specify	Specify	6-1496634-670	\$352.95	6-1496646-670	\$366.95
Laminate	18 in A+	Painted	Black	Specify	Specify	Specify	6-1496635-670	\$339.95	6-1496647-670	\$352.95
Laminate <b>NEW</b>	18 in A+	T-Mold	Chrome	Specify	Specify	Specify	6-5009366-670	\$352.95	6-5009386-670	\$366.95
Laminate <b>NEW</b>	18 in A+	T-Mold	Black	Specify	Specify	Specify	6-5009380-670	\$339.95	6-5009372-670	\$352.95
Hard Plastic	18 in A+	-	Chrome	Specify	Specify	-	6-1496638-670	\$379.95	6-1496650-670	\$392.95
Hard Plastic	18 in A+	-	Black	Specify	Specify	-	6-1496639-670	\$366.95	6-1496651-670	\$379.95
Laminate	18 in A+	LockEdge	Chrome	Specify	Specify	Specify	6-1496636-670	\$386.95	6-1496648-670	\$399.95
Laminate	18 in A+	LockEdge	Black	Specify	Specify	Specify	6-1496637-670	\$372.95	6-1496649-670	\$386.95
Laminate	18 in	Painted	Chrome	Specify	Specify	Specify	6-1496640-670	\$346.95	6-1496652-670	\$359.95
Laminate	18 in	Painted	Black	Specify	Specify	Specify	6-1496641-670	\$332.95	6-1496653-670	\$346.95
Laminate <b>NEW</b>	18 in	T-Mold	Chrome	Specify	Specify	Specify	6-5009379-670	\$346.95	6-5009371-670	\$359.95
Laminate <b>NEW</b>	18 in	T-Mold	Black	Specify	Specify	Specify	6-5009373-670	\$332.95	6-5009387-670	\$346.95
Hard Plastic	18 in	-	Chrome	Specify	Specify	-	6-1496644-670	\$372.95	6-1496656-670	\$386.95
Hard Plastic	18 in	-	Black	Specify	Specify	-	6-1496645-670	\$359.95	6-1496657-670	\$372.95
Laminate	18 in	LockEdge	Chrome	Specify	Specify	Specify	6-1496642-670	\$379.95	6-1496654-670	\$392.95
Laminate	18 in	LockEdge	Black	Specify	Specify	Specify	6-1496643-670	\$366.95	6-1496655-670	\$379.95

Item #	Description	List Price
9-1499641-670	Chrome Wire Book Basket	\$22.95
9-1499644-670	Black Wire Book Basket	\$22.95

Item #	Description	List Price
9-1489095-670	Snap on Felt Glide	\$1.65



### Classroom Select® Contemporary Sled Base Combination Desk

With the well-fitting ergonomic Contemporary soft plastic chair shell and a tubular steel frame, this sled base combination desk offers the strength and durability needed in today's classroom. The sled base frame slides effortlessly on carpet for easy mobility and reconfiguration, and allows entry from either side. Desktops available in either hard plastic or high pressure laminate; laminate tops come with your choice of colored LockEdge®, T-Mold edge, or painted edge in beige or titanium. Choose between an 18" x 24" or a larger 20" x 26" top, as well as an 18" chair shell, or an 18" A+ size featuring a 30% larger surface area than the standard 18". Optional field installable wire book racks are available. Assembled. **Please order in carton quantities of two.**

Top Type	Seat Height	Edge Type	Frame Color	Seat and Back Color	Top Color	Edge Color	18 x 24 in Top Size		20 x 26 in Top Size	
							Item #	List Price	Item #	List Price
Laminate	18 in A+	Painted	Chrome	Specify	Specify	Specify	6-1496554-670	\$326.95	6-1496560-670	\$339.95
Laminate	18 in A+	Painted	Black	Specify	Specify	Specify	6-1496555-670	\$312.95	6-1496561-670	\$326.95
Laminate <b>NEW</b>	18 in A+	T-Mold	Chrome	Specify	Specify	Specify	6-5009377-670	\$326.95	6-5009382-670	\$339.95
Laminate <b>NEW</b>	18 in A+	T-Mold	Black	Specify	Specify	Specify	6-5009374-670	\$312.95	6-5009384-670	\$326.95
Hard Plastic	18 in A+	-	Chrome	Specify	Specify	-	6-1496558-670	\$352.95	6-1496564-670	\$366.95
Hard Plastic	18 in A+	-	Black	Specify	Specify	-	6-1496559-670	\$339.95	6-1496565-670	\$352.95
Laminate	18 in A+	LockEdge	Chrome	Specify	Specify	Specify	6-1496556-670	\$359.95	6-1496562-670	\$372.95
Laminate	18 in A+	LockEdge	Black	Specify	Specify	Specify	6-1496557-670	\$346.95	6-1496563-670	\$359.95
Laminate	18 in	Painted	Chrome	Specify	Specify	Specify	6-1429126-670	\$319.95	6-1444529-670	\$332.95
Laminate	18 in	Painted	Black	Specify	Specify	Specify	6-1429128-670	\$306.95	6-1444531-670	\$319.95
Laminate <b>NEW</b>	18 in	T-Mold	Chrome	Specify	Specify	Specify	6-5009385-670	\$319.95	6-5009389-670	\$332.95
Laminate <b>NEW</b>	18 in	T-Mold	Black	Specify	Specify	Specify	6-5009388-670	\$306.95	6-5009383-670	\$319.95
Hard Plastic	18 in	-	Chrome	Specify	Specify	-	6-1429130-670	\$346.95	6-1444533-670	\$359.95
Hard Plastic	18 in	-	Black	Specify	Specify	-	6-1429131-670	\$332.95	6-1444534-670	\$346.95
Laminate	18 in	LockEdge	Chrome	Specify	Specify	Specify	6-1429127-670	\$352.95	6-1444530-670	\$366.95
Laminate	18 in	LockEdge	Black	Specify	Specify	Specify	6-1429129-670	\$339.95	6-1444532-670	\$352.95

Item #	Description	List Price
9-1499641-670	Chrome Wire Book Basket	\$22.95
9-1499644-670	Black Wire Book Basket	\$22.95

Item #	Description	List Price
9-1489095-670	Snap on Felt Glide	\$1.65



Refer to pages 60-61 for color options.



PRODUCT CERTIFIED FOR LOW CHEMICAL EMISSIONS: UL.COM/GGG UL-2818



**Classroom Select® Royal Seating® 1400 Sled Base Combination Desk**

The Royal Seating® 1400 Sled Base Combination desk features the Royal Seating® 1100 chair shell with an 18" x 24" or 20" x 26" top on a 1-1/8" chrome plated or black powdercoat tubular steel frame. The sled base design allows for easy mobility on carpeted flooring, as well as entry from either side. Desktops available in either hard plastic or high pressure laminate; laminate tops come with your choice of colored LockEdge®, T-Mold edge, or painted edge in beige or titanium. An optional field installed wire book basket is sold separately. Available in your choice of the A shell or the larger, more accommodating A+ shell size. Assembled. **Please order in carton quantities of two.**

Top Type	Seat Height	Edge Type	Frame Color	Seat and Back Color	Top Color	Edge Color	18 x 24 in Top Size		20 x 26 in Top Size	
							Item #	List Price	Item #	List Price
Laminate	18 in A+	Painted	Chrome	Specify	Specify	Specify	6-5009922-670	\$319.95	6-5009920-670	\$332.95
Laminate	18 in A+	Painted	Black	Specify	Specify	Specify	6-5009923-670	\$306.95	6-5009921-670	\$319.95
Laminate	<b>NEW</b> 18 in A+	T-Mold	Chrome	Specify	Specify	Specify	6-1496566-670	\$319.95	6-1496572-670	\$332.95
Laminate	<b>NEW</b> 18 in A+	T-Mold	Black	Specify	Specify	Specify	6-1496567-670	\$306.95	6-1496573-670	\$319.95
Hard Plastic	18 in A+	-	Chrome	Specify	Specify	-	6-1496568-670	\$346.95	6-1496574-670	\$359.95
Hard Plastic	18 in A+	-	Black	Specify	Specify	-	6-1496569-670	\$332.95	6-1496575-670	\$346.95
Laminate	18 in A+	LockEdge	Chrome	Specify	Specify	Specify	6-1496570-670	\$352.95	6-1496576-670	\$366.95
Laminate	18 in A+	LockEdge	Black	Specify	Specify	Specify	6-1496571-670	\$339.95	6-1496577-670	\$352.95
Laminate	18 in	Painted	Chrome	Specify	Specify	Specify	6-5009926-670	\$312.95	6-5009924-670	\$326.95
Laminate	18 in	Painted	Black	Specify	Specify	Specify	6-5009927-670	\$299.95	6-5009925-670	\$312.95
Laminate	<b>NEW</b> 18 in	T-Mold	Chrome	Specify	Specify	Specify	6-1496578-670	\$312.95	6-1496584-670	\$326.95
Laminate	<b>NEW</b> 18 in	T-Mold	Black	Specify	Specify	Specify	6-1496579-670	\$299.95	6-1496585-670	\$312.95
Hard Plastic	18 in	-	Chrome	Specify	Specify	-	6-1496580-670	\$339.95	6-1496586-670	\$352.95
Hard Plastic	18 in	-	Black	Specify	Specify	-	6-1496581-670	\$326.95	6-1496587-670	\$339.95
Laminate	18 in	LockEdge	Chrome	Specify	Specify	Specify	6-1496582-670	\$346.95	6-1496588-670	\$359.95
Laminate	18 in	LockEdge	Black	Specify	Specify	Specify	6-1496583-670	\$332.95	6-1496589-670	\$346.95

Item #	Description	List Price	Item #	Description	List Price
9-1499641-670	Chrome Wire Book Basket	\$22.95	9-1489095-670	Snap on Felt Glide	\$1.65
9-1499644-670	Black Wire Book Basket	\$22.95			



**Classroom Select® Traditional Sled Base Combination Desk**

The Traditional Sled Base Combination desk is available with an 18" x 24" or 20" x 26" top on a 1-1/8" chrome plated or black powder coat tubular steel frame. The sled base design allows for easy mobility on carpeted flooring, as well as entry from either side. Desktops available in either hard plastic or high pressure laminate; laminate tops come with your choice of colored LockEdge®, T-Mold edge, or painted edge in beige or titanium. An optional field installed wire book basket is sold separately. Available in your choice of the A shell or the larger, more accommodating A+ shell size. Assembled. **Please order in carton quantities of two.**

Top Type	Seat Height	Edge Type	Frame Color	Seat and Back Color	Top Color	Edge Color	18 x 24 in Top Size		20 x 26 in Top Size	
							Item #	List Price	Item #	List Price
Laminate	18-1/2 in A+	Painted	Chrome	Specify	Specify	Specify	6-1503582-670	\$306.95	6-1503586-670	\$319.95
Laminate	18-1/2 in A+	Painted	Black	Specify	Specify	Specify	6-1503583-670	\$292.95	6-1503587-670	\$306.95
Laminate	<b>NEW</b> 18-1/2 in A+	T-Mold	Chrome	Specify	Specify	Specify	6-5009376-670	\$306.95	6-5009375-670	\$319.95
Laminate	<b>NEW</b> 18-1/2 in A+	T-Mold	Black	Specify	Specify	Specify	6-5009378-670	\$292.95	6-5009369-670	\$306.95
Hard Plastic	18-1/2 in A+	-	Chrome	Specify	Specify	-	6-1503590-670	\$332.95	6-1503594-670	\$346.95
Hard Plastic	18-1/2 in A+	-	Black	Specify	Specify	-	6-1503591-670	\$319.95	6-1503595-670	\$326.95
Laminate	18-1/2 in A+	LockEdge	Chrome	Specify	Specify	Specify	6-1503598-670	\$339.95	6-1503602-670	\$352.95
Laminate	18-1/2 in A+	LockEdge	Black	Specify	Specify	Specify	6-1503599-670	\$326.95	6-1503603-670	\$339.95
Laminate	17-1/2 in	Painted	Chrome	Specify	Specify	Specify	6-1503580-670	\$299.95	6-1503584-670	\$312.95
Laminate	17-1/2 in	Painted	Black	Specify	Specify	Specify	6-1503581-670	\$286.95	6-1503585-670	\$299.95
Laminate	<b>NEW</b> 17-1/2 in	T-Mold	Chrome	Specify	Specify	Specify	6-5009367-670	\$299.95	6-5009368-670	\$312.95
Laminate	<b>NEW</b> 17-1/2 in	T-Mold	Black	Specify	Specify	Specify	6-5009370-670	\$286.95	6-5009381-670	\$299.95
Hard Plastic	17-1/2 in	-	Chrome	Specify	Specify	-	6-1503588-670	\$326.95	6-1503592-670	\$339.95
Hard Plastic	17-1/2 in	-	Black	Specify	Specify	-	6-1503589-670	\$312.95	6-1503593-670	\$326.95
Laminate	17-1/2 in	LockEdge	Chrome	Specify	Specify	Specify	6-1503596-670	\$332.95	6-1503600-670	\$346.95
Laminate	17-1/2 in	LockEdge	Black	Specify	Specify	Specify	6-1503597-670	\$319.95	6-1503601-670	\$332.95

Item #	Description	List Price	Item #	Description	List Price
9-1499641-670	Chrome Wire Book Basket	\$22.95	9-1489095-670	Snap on Felt Glide	\$1.65
9-1499644-670	Black Wire Book Basket	\$22.95			



**CLASSROOM  
SELECT** 

 PLEASE SPECIFY  
COLOR CHOICE

Refer to pages 60-61  
for color options.



PRODUCT CERTIFIED  
FOR LOW CHEMICAL  
EMISSIONS:  
UL COM/CGG  
UL 2818  
GOLD



Shown with  
optional Book Box



Laminate Top  
w/Apollo Legs



Laminate Top  
w/Standard Legs

**Classroom Select® Traditional Desks**

Classroom Select® Traditional Desks are perfect for any learning environment. Durable desktops are available in 5/8-inch MDF laminate with natural urethane painted edge, black T-Mold edge, or black LockEdge® that adds an appealing textured look and durability. Choose from an expansive selection of solids, patterns and markerboard laminate colors. Optional black metal book box is available only on the 20 x 30 inch as a separate purchase. Choose from 15" to 25" or 22" to 30" adjustable leg available in black only. Recommended to use 16" or smaller size chair for the 20 x 26 top with NeoClass® Elliptical and Apollo® Legs.

Top Shape	Product Dimensions	Product Height	Edge Type	Edge Color	Leg Type	Leg Color	Laminate Top			Markerboard Top	
							Item #	Top Color	List Price	Item #	List Price
Rectangle	26 W x 20 D in	Specify	Painted	Beige	Standard	Ebony	6-5008428-670	Specify	\$159.95	6-5008437-670	\$172.95
Rectangle	26 W x 20 D in	Specify	Painted	Beige	Apollo	Ebony	6-5008427-670	Specify	\$179.95	6-5008436-670	\$192.95
Rectangle	26 W x 20 D in	Specify	Painted	Beige	NeoClass	Ebony	6-5008426-670	Specify	\$192.95	6-5008435-670	\$206.95
Rectangle	26 W x 20 D in	Specify	T-Mold	Ebony	Standard	Ebony	6-5008431-670	Specify	\$159.95	6-5008440-670	\$172.95
Rectangle	26 W x 20 D in	Specify	T-Mold	Ebony	Apollo	Ebony	6-5008430-670	Specify	\$179.95	6-5008439-670	\$192.95
Rectangle	26 W x 20 D in	Specify	T-Mold	Ebony	NeoClass	Ebony	6-5008429-670	Specify	\$192.95	6-5008438-670	\$206.95
Rectangle	26 W x 20 D in	Specify	LockEdge	Ebony	Standard	Ebony	6-5008434-670	Specify	\$172.95	6-5008443-670	\$186.95
Rectangle	26 W x 20 D in	Specify	LockEdge	Ebony	Apollo	Ebony	6-5008433-670	Specify	\$192.95	6-5008442-670	\$206.95
Rectangle	26 W x 20 D in	Specify	LockEdge	Ebony	NeoClass	Ebony	6-5008432-670	Specify	\$206.95	6-5008441-670	\$219.95
Rectangle	30 W x 20 D in	Specify	Painted	Beige	Standard	Ebony	6-5008458-670	Specify	\$166.95	6-5008467-670	\$179.95
Rectangle	30 W x 20 D in	Specify	Painted	Beige	Apollo	Ebony	6-5008457-670	Specify	\$186.95	6-5008466-670	\$199.95
Rectangle	30 W x 20 D in	Specify	Painted	Beige	NeoClass	Ebony	6-5008456-670	Specify	\$199.95	6-5008465-670	\$212.95
Rectangle	30 W x 20 D in	Specify	T-Mold	Ebony	Standard	Ebony	6-5008461-670	Specify	\$166.95	6-5008470-670	\$179.95
Rectangle	30 W x 20 D in	Specify	T-Mold	Ebony	Apollo	Ebony	6-5008460-670	Specify	\$186.95	6-5008469-670	\$199.95
Rectangle	30 W x 20 D in	Specify	T-Mold	Ebony	NeoClass	Ebony	6-5008459-670	Specify	\$199.95	6-5008468-670	\$212.95
Rectangle	30 W x 20 D in	Specify	LockEdge	Ebony	Standard	Ebony	6-5008464-670	Specify	\$179.95	6-5008473-670	\$192.95
Rectangle	30 W x 20 D in	Specify	LockEdge	Ebony	Apollo	Ebony	6-5008463-670	Specify	\$199.95	6-5008472-670	\$212.95
Rectangle	30 W x 20 D in	Specify	LockEdge	Ebony	NeoClass	Ebony	6-5008462-670	Specify	\$212.95	6-5008471-670	\$226.95

Item #	Description	List Price
9-1547618-670	Activity Table Book Box	\$27.95

**Classroom Select® NeoClass® Activity Desks**

Classroom Select® NeoClass® Activity Desks are perfect for any learning environment. Durable desktops are available in 1-1/8-inch MDF laminate with a black T-Mold edge or black LockEdge® that adds an appealing textured look and durability. Choose from an expansive selection of solids, patterns and markerboard laminate colors. Optional black metal book box is available only on the 20 x 30 inch as a separate purchase. Choose from 15" to 25" or 22" to 30" adjustable leg available in black only. Recommended to use 16" or smaller size chair for the 20 x 26 top with NeoClass® Elliptical and Apollo® Legs.



Laminate Top  
w/Apollo Legs



Shown with  
optional Book Box



Laminate Top  
w/Standard Legs

Top Shape	Product Dimensions	Product Height	Edge Type	Edge Color	Leg Type	Leg Color	Laminate Top			Markerboard Top	
							Item #	Top Color	List Price	Item #	List Price
Rectangle	26 W x 20 D in	Specify	T-Mold	Ebony	Standard	Ebony	6-5008446-670	Specify	\$192.95	6-5008452-670	\$206.95
Rectangle	26 W x 20 D in	Specify	T-Mold	Ebony	Apollo	Ebony	6-5008445-670	Specify	\$212.95	6-5008451-670	\$226.95
Rectangle	26 W x 20 D in	Specify	T-Mold	Ebony	NeoClass	Ebony	6-5008444-670	Specify	\$226.95	6-5008450-670	\$239.95
Rectangle	26 W x 20 D in	Specify	LockEdge	Ebony	Standard	Ebony	6-5008449-670	Specify	\$226.95	6-5008455-670	\$239.95
Rectangle	26 W x 20 D in	Specify	LockEdge	Ebony	Apollo	Ebony	6-5008448-670	Specify	\$246.95	6-5008454-670	\$259.95
Rectangle	26 W x 20 D in	Specify	LockEdge	Ebony	NeoClass	Ebony	6-5008447-670	Specify	\$259.95	6-5008453-670	\$272.95
Rectangle	30 W x 20 D in	Specify	T-Mold	Ebony	Standard	Ebony	6-5008476-670	Specify	\$206.95	6-5008482-670	\$219.95
Rectangle	30 W x 20 D in	Specify	T-Mold	Ebony	Apollo	Ebony	6-5008475-670	Specify	\$226.95	6-5008481-670	\$239.95
Rectangle	30 W x 20 D in	Specify	T-Mold	Ebony	NeoClass	Ebony	6-5008474-670	Specify	\$239.95	6-5008480-670	\$252.95
Rectangle	30 W x 20 D in	Specify	LockEdge	Ebony	Standard	Ebony	6-5008479-670	Specify	\$239.95	6-5008485-670	\$252.95
Rectangle	30 W x 20 D in	Specify	LockEdge	Ebony	Apollo	Ebony	6-5008478-670	Specify	\$259.95	6-5008484-670	\$272.95
Rectangle	30 W x 20 D in	Specify	LockEdge	Ebony	NeoClass	Ebony	6-5008477-670	Specify	\$272.95	6-5008483-670	\$286.95

Item #	Description	List Price
9-1547618-670	Activity Table Book Box	\$27.95



PRODUCT CERTIFIED FOR LOW CHEMICAL EMISSIONS: UL-COMM66 UL 2818



Refer to pages 60-61 for color options.



**Classroom Select® NeoShape® Shaped Desks**

These shaped desks have a laminate or markerboard top and are perfect for collaborative interaction, encouraging student creativity and learning. Desks can be arranged in various configurations for shared connectivity, flexibility, and mobility. Desks with T-Mold edge are made of 1-1/8" particleboard core, and LockEdge® is made of 1-1/8" MDF core with high pressure laminate top, and phenolic resin backer. New premium elliptical leg adjusts from 15" to 24" or 22" to 30". T-Mold edge, top leg color will match the selected edge color. LockEdge®, top leg color will be black. Backed by a limited lifetime warranty.

Top Shape	Product Dimensions	Product Height	Edge Color	Leg Color	Laminate Top			Markerboard Top	
					Item #	Top Color	List Price	Item #	List Price
<b>T-Mold Edge</b>									
Boomerang	36 W x 26 D in	Specify	Specify	Specify	6-1598273-670	Specify	\$266.95	6-1598274-670	\$299.95
Ribbon	31 W x 21 D in	Specify	Specify	Specify	6-1598261-670	Specify	\$266.95	6-1598262-670	\$299.95
Triangle	46 W x 24 D in	Specify	Specify	Specify	6-1598281-670	Specify	\$266.95	6-1598282-670	\$299.95
Volcano	38 W x 20 D in	Specify	Specify	Specify	6-1598293-670	Specify	\$266.95	6-1598294-670	\$299.95
Vortex	33 W x 20 D in	Specify	Specify	Specify	6-1598321-670	Specify	\$266.95	6-1598322-670	\$299.95
Waverly	30 W x 24 D in	Specify	Specify	Specify	6-1598253-670	Specify	\$266.95	6-1598254-670	\$299.95
Canopy	35 W x 20 D in	Specify	Specify	Specify	6-1598289-670	Specify	\$272.95	6-1598290-670	\$306.95
Bridge	40 W x 20 D in	Specify	Specify	Specify	6-1598249-670	Specify	\$279.95	6-1598250-670	\$312.95
Fan	30 W x 28 D in	Specify	Specify	Specify	6-1598265-670	Specify	\$279.95	6-1598266-670	\$312.95
Gem	31 W x 27 D in	Specify	Specify	Specify	6-1598305-670	Specify	\$279.95	6-1598306-670	\$312.95
Kite	34 W x 30 D in	Specify	Specify	Specify	6-1598309-670	Specify	\$286.95	6-1598310-670	\$319.95
Prop	34 W x 31 D in	Specify	Specify	Specify	6-1598313-670	Specify	\$286.95	6-1598314-670	\$319.95
Tasa	36 W x 28 D in	Specify	Specify	Specify	6-1598285-670	Specify	\$286.95	6-1598286-670	\$319.95
Ovoid	34 W x 34 D in	Specify	Specify	Specify	6-1598277-670	Specify	\$306.95	6-1598278-670	\$339.95
<b>LockEdge®</b>									
Boomerang	36 W x 26 D in	Specify	Specify	Specify	6-1598272-670	Specify	\$332.95	6-1598275-670	\$366.95
Ribbon	31 W x 21 D in	Specify	Specify	Specify	6-1598260-670	Specify	\$332.95	6-1598263-670	\$366.95
Triangle	46 W x 24 D in	Specify	Specify	Specify	6-1598280-670	Specify	\$332.95	6-1598283-670	\$366.95
Volcano	38 W x 20 D in	Specify	Specify	Specify	6-1598292-670	Specify	\$332.95	6-1598295-670	\$366.95
Vortex	33 W x 20 D in	Specify	Specify	Specify	6-1598320-670	Specify	\$332.95	6-1598323-670	\$366.95
Waverly	30 W x 24 D in	Specify	Specify	Specify	6-1598252-670	Specify	\$332.95	6-1598255-670	\$366.95
Canopy	35 W x 20 D in	Specify	Specify	Specify	6-1598288-670	Specify	\$339.95	6-1598291-670	\$372.95
Bridge	40 W x 20 D in	Specify	Specify	Specify	6-1598248-670	Specify	\$346.95	6-1598251-670	\$379.95
Fan	30 W x 28 D in	Specify	Specify	Specify	6-1598264-670	Specify	\$346.95	6-1598267-670	\$379.95
Gem	31 W x 27 D in	Specify	Specify	Specify	6-1598304-670	Specify	\$346.95	6-1598307-670	\$379.95
Kite	34 W x 30 D in	Specify	Specify	Specify	6-1598308-670	Specify	\$352.95	6-1598311-670	\$386.95
Prop	34 W x 31 D in	Specify	Specify	Specify	6-1598312-670	Specify	\$352.95	6-1598315-670	\$386.95
Tasa	36 W x 28 D in	Specify	Specify	Specify	6-1598284-670	Specify	\$352.95	6-1598287-670	\$386.95
Ovoid	34 W x 34 D in	Specify	Specify	Specify	6-1598276-670	Specify	\$372.95	6-1598279-670	\$406.95

boomerang

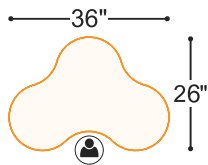

bridge

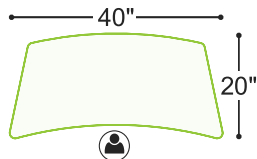

canopy

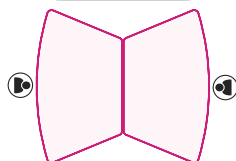
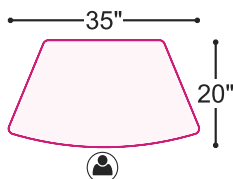

fan

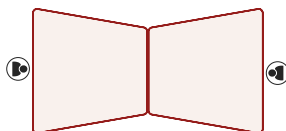
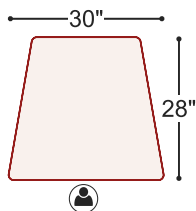

gem

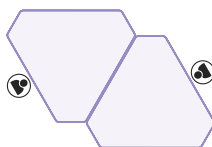
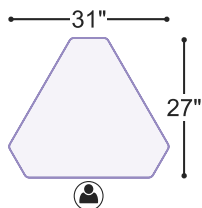

kite

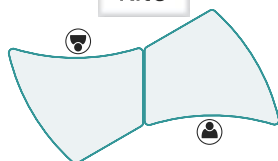
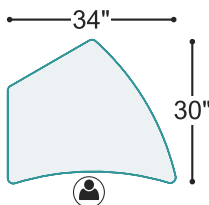

ovoid

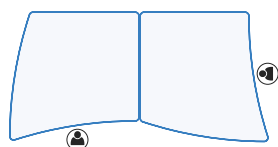
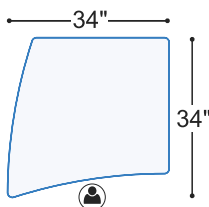

34"

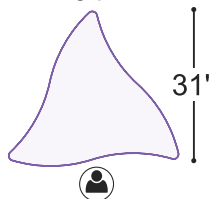

prop

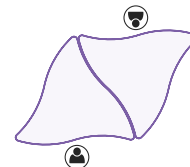

ribbon

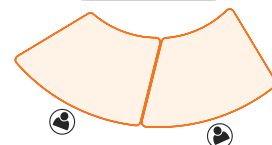
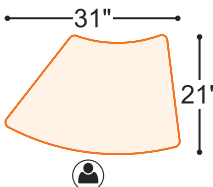

tasa

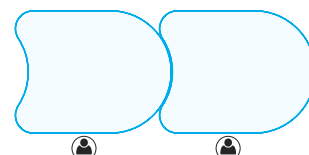
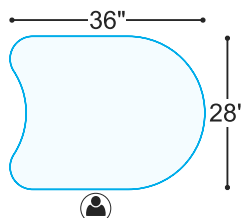

triangle

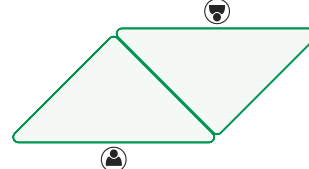
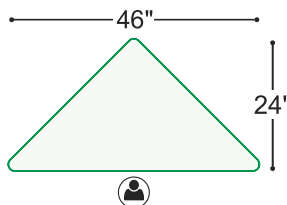

volcano

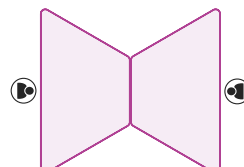
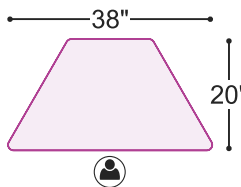

vortex

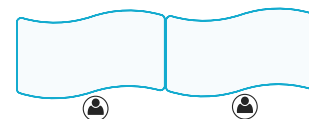
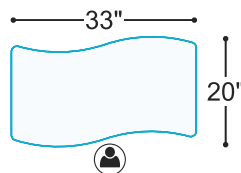

waverly

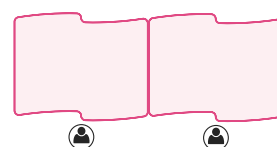
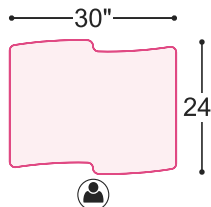





PRODUCT CERTIFIED FOR LOW CHEMICAL EMISSIONS: UL COMING UL 2819



Refer to pages 60-61 for color options.



Hard Plastic Top with Casters



Laminate with LockEdge® without Casters

### Classroom Select® NeoMove® Collaboration Desk

The Classroom Select® NeoMove® Collaboration Desk features a unique shape design capable of adapting into a variety of collaborative groupings. With round, 1-1/4" legs that are adjustable from 22" to 30" height, and two optional locking casters for easy reconfiguration, the NeoMove® assembled desk presents the perfect solution for today's constantly evolving classroom. Available with a high pressure laminate surface and painted edge, or sprayed polyurethane colored LockEdge® for added cleanliness and durability, as well as a 5/8" thick high-impact, solid plastic that has been molded into a homogeneous unit by heat and pressure, or markerboard top. Available with your choice of a pass-through wire book rack, pass-through perforated book box, pass-through full metal book box, or 3 sided book box. Please select bookrack or book box option when ordering.

Top Type	Edge Type	Product Height	Top Size	Top Color	Edge Color	Without Book Box		With Book Box or Book Rack		
						Item #	List Price	Item #	Book Box Type	List Price
<b>NeoMove® Collaboration Desk with Casters</b>										
Laminate	Painted	22 to 30 in	27 W x 25 D in	Specify	Specify	6-1527625-670	\$506.95	6-1576463-670	Specify	\$539.95
Laminate	T-Mold	22 to 30 in	27 W x 25 D in	Specify	Specify	6-5009397-670	\$506.95	6-5009337-670	Specify	\$539.95
Hard Plastic	-	22 to 30 in	27 W x 25 D in	Specify	-	6-1527627-670	\$526.95	6-1576464-670	Specify	\$559.95
Laminate	LockEdge	22 to 30 in	27 W x 25 D in	Specify	Specify	6-1527626-670	\$539.95	6-1576465-670	Specify	\$572.95
Markerboard	Painted	22 to 30 in	27 W x 25 D in	White	Specify	6-5009606-670	\$539.95	6-5009614-670	Specify	\$572.95
Markerboard	T-Mold	22 to 30 in	27 W x 25 D in	White	Specify	6-5009607-670	\$539.95	6-5009615-670	Specify	\$572.95
Markerboard	LockEdge	22 to 30 in	27 W x 25 D in	White	Specify	6-5009609-670	\$569.95	6-5009617-670	Specify	\$602.95
<b>NeoMove® Collaboration Desk without Casters</b>										
Laminate	Painted	22 to 30 in	27 W x 25 D in	Specify	Specify	6-1527628-670	\$472.95	6-1576460-670	Specify	\$506.95
Laminate	T-Mold	22 to 30 in	27 W x 25 D in	Specify	Specify	6-5009404-670	\$472.95	6-5009348-670	Specify	\$506.95
Hard Plastic	-	22 to 30 in	27 W x 25 D in	Specify	-	6-1527630-670	\$492.95	6-1576461-670	Specify	\$526.95
Laminate	LockEdge	22 to 30 in	27 W x 25 D in	Specify	Specify	6-1527629-670	\$506.95	6-1576462-670	Specify	\$539.95
Markerboard	Painted	22 to 30 in	27 W x 25 D in	White	Specify	6-5009610-670	\$506.95	6-5009618-670	Specify	\$539.95
Markerboard	T-Mold	22 to 30 in	27 W x 25 D in	White	Specify	6-5009611-670	\$506.95	6-5009619-670	Specify	\$539.95
Markerboard	LockEdge	22 to 30 in	27 W x 25 D in	White	Specify	6-5009613-670	\$536.95	6-5009621-670	Specify	\$569.95

Item # 9-2051358-670 Description Gray Backpack Hook

List Price \$6.65

**Why Five?**

Research shows that five is the optimum group size for collaborative learning. NeoMove® Desks can easily be arranged into groups of five.





Refer to pages 60-61 for color options.



PRODUCT CERTIFIED FOR LOW CHEMICAL EMISSIONS: UL.COM/CSG UL-2818



**Gem with Tote Rail**



**MiniGem**



**Triangle with Book Box**



**Rectangle with Backpack Hook**



Desk shown with optional tote rails that are compatible with storage totes. See pages 253-256 for storage options

**Classroom Select® Concord Desk**

Bring students together with the Classroom Select® Concord Desk. Collaborative work environments are made simple with four different shape options. Select from the Gem or Mini-Gem shape for groupings of up to six, the Triangle shape for groups of four, or get creative with the traditional 27" x 20" Rectangle shape. Select from the study top desk with a 14-gauge steel frame or add the optional tote rails that accommodate storage trays (sold separately). Also available as an open front desk featuring an 18-gauge welded steel book box. Select from a vinyl T-Mold edge on a 1-1/8" particle board core or sprayed on colored LockEdge® for added durability on a 1-1/8" MDF core. Adjustable leg height from 22" to 32" on 1" increments. Add mobility to your classroom with 3" locking casters, sold separately.

Top Shape	Product Dimensions	Edge Type	Edge Color	Product Height	Laminate Top			Markerboard Top	
					Item #	Top Color	List Price	Item #	List Price
<b>Study Top Desk</b>									
Gem	34 W x 30 D in	T-Mold	Specify	22-32 in H	6-5002453-670	Specify	\$206.95	6-5002458-670	\$239.95
Gem	34 W x 30 D in	LockEdge	Specify	22-32 in H	6-5002435-670	Specify	\$272.95	6-5004823-670	\$306.95
Triangle	41 W x 23-1/2 D in	T-Mold	Specify	22-32 in H	6-5002457-670	Specify	\$259.95	6-5002455-670	\$292.95
Triangle	41 W x 23-1/2 D in	LockEdge	Specify	22-32 in H	6-5002466-670	Specify	\$326.95	6-5004825-670	\$359.95
MiniGem	30-1/2 W x 27 D in	T-Mold	Specify	22-32 in H	6-5002459-670	Specify	\$272.95	6-5002456-670	\$306.95
MiniGem	30-1/2 W x 27 D in	LockEdge	Specify	22-32 in H	6-5002447-670	Specify	\$339.95	6-5004824-670	\$372.95
Rectangle	27 W x 20 D in	T-Mold	Specify	22-32 in H	6-5002462-670	Specify	\$306.95	6-5002468-670	\$339.95
Rectangle	27 W x 20 D in	LockEdge	Specify	22-32 in H	6-5002451-670	Specify	\$372.95	6-5004826-670	\$406.95
<b>Study Top with Tote Rails</b>									
Gem	34 W x 30 D in	T-Mold	Specify	22-32 in H	6-5002436-670	Specify	\$339.95	6-5002446-670	\$372.95
Gem	34 W x 30 D in	LockEdge	Specify	22-32 in H	6-5002442-670	Specify	\$406.95	6-5004827-670	\$439.95
Triangle	41 W x 23-1/2 D in	T-Mold	Specify	22-32 in H	6-5002464-670	Specify	\$392.95	6-5002476-670	\$426.95
Triangle	41 W x 23-1/2 D in	LockEdge	Specify	22-32 in H	6-5002475-670	Specify	\$459.95	6-5004829-670	\$492.95
MiniGem	30-1/2 W x 27 D in	T-Mold	Specify	22-32 in H	6-5002469-670	Specify	\$406.95	6-5002474-670	\$439.95
MiniGem	30-1/2 W x 27 D in	LockEdge	Specify	22-32 in H	6-5002444-670	Specify	\$472.95	6-5004828-670	\$506.95
Rectangle	27 W x 20 D in	T-Mold	Specify	22-32 in H	6-5002463-670	Specify	\$439.95	6-5002449-670	\$472.95
Rectangle	27 W x 20 D in	LockEdge	Specify	22-32 in H	6-5002472-670	Specify	\$506.95	6-5004830-670	\$539.95
<b>Open Front Desk with Book Box</b>									
Gem	34 W x 30 D in	T-Mold	Specify	22-32 in H	6-5001091-670	Specify	\$306.95	6-5001093-670	\$339.95
Gem	34 W x 30 D in	LockEdge	Specify	22-32 in H	6-5001092-670	Specify	\$372.95	6-5004803-670	\$406.95
Triangle	41 W x 23-1/2 D in	T-Mold	Specify	22-32 in H	6-5002445-670	Specify	\$359.95	6-5002441-670	\$392.95
Triangle	41 W x 23-1/2 D in	LockEdge	Specify	22-32 in H	6-5002438-670	Specify	\$426.95	6-5004806-670	\$459.95
MiniGem	30-1/2 W x 27 D in	T-Mold	Specify	22-32 in H	6-5002470-670	Specify	\$372.95	6-5002452-670	\$406.95
MiniGem	30-1/2 W x 27 D in	LockEdge	Specify	22-32 in H	6-5002437-670	Specify	\$439.95	6-5004805-670	\$472.95

Item #	Description	List Price
9-2038890-670	Backpack Hook	\$7.25
9-2027667-670	3 in Tote Tray	\$17.95
9-2040211-670	Table Casters - Set of 3	\$23.95
9-2040212-670	Table Casters - Set of 4	\$30.95

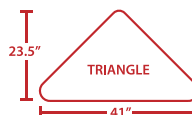
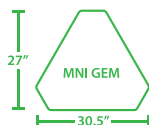
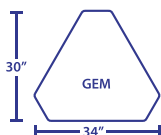

**CLASSROOM  
SELECT**



PRODUCT CERTIFIED FOR LOW CHEMICAL EMISSIONS: UL.COM/IGG UL 2818



Refer to pages 60-61 for color options.



**Classroom Select® Contemporary Collaboration Fixed Height Desk**

Classroom Select® Contemporary Collaboration Fixed Height Desks create an ideal learning environment for collaboration and flexibility. The unique design helps create a classroom that can be grouped together or worked individually. Desks are available in either hard plastic or laminate; laminate tops come with your choice of colored LockEdge®, T-Mold edge, or painted edge in beige or titanium. Features a full nickel chrome frame finish in 30" fixed height. Select from an optional chrome wire book rack or black metal book box to accommodate all storage needs. Available with or without 2 lockable casters. **Quickship available, without book rack or book box and without casters in the following top color options: Gray Nebula, Fusion Maple, Bannister Oak or Nepal Teak for laminate. Light Gray, Beach (Beige) or Sugar Maple for Hard Plastic.**

Top Shape	Top Type	Edge Type	Top Dimensions	Top Color	Edge Color	Without Book Box		With Book Box		
						Item #	List Price	Item #	Book Box Type	List Price
<b>Fixed Height 30" without Casters</b>										
Rectangle	Laminate	Painted	26 W x 20 D in	Specify	Specify	6-1554996-670	\$232.95	6-1576484-670	Specify	\$266.95
Rectangle	Laminate	T-Mold	26 W x 20 D in	Specify	Specify	6-5009405-670	\$232.95	6-5009356-670	Specify	\$266.95
Rectangle	Hard Plastic	—	26 W x 20 D in	Specify	—	6-1554997-670	\$259.95	6-1576485-670	Specify	\$292.95
Rectangle	Laminate	LockEdge	26 W x 20 D in	Specify	Specify	6-1554998-670	\$266.95	6-1576486-670	Specify	\$299.95
Triangle	Laminate	Painted	36 W x 24 D in	Specify	Specify	6-1425932-670	\$246.95	6-1576466-670	Specify	\$279.95
Triangle	Laminate	T-Mold	36 W x 24 D in	Specify	Specify	6-5009419-670	\$246.95	6-5009346-670	Specify	\$279.95
Triangle	Hard Plastic	—	36 W x 24 D in	Specify	—	6-1395310-670	\$272.95	6-1576468-670	Specify	\$306.95
Triangle	Laminate	LockEdge	36 W x 24 D in	Specify	Specify	6-1426974-670	\$279.95	6-1576467-670	Specify	\$312.95
Hexagon	Laminate	Painted	33 W x 21 D in	Specify	Specify	6-1444509-670	\$246.95	6-1576472-670	Specify	\$279.95
Hexagon	Laminate	T-Mold	33 W x 21 D in	Specify	Specify	6-5009400-670	\$246.95	6-5009349-670	Specify	\$279.95
Hexagon	Hard Plastic	—	33 W x 21 D in	Specify	—	6-1441892-670	\$272.95	6-1576474-670	Specify	\$306.95
Hexagon	Laminate	LockEdge	33 W x 21 D in	Specify	Specify	6-1441895-670	\$279.95	6-1576473-670	Specify	\$312.95
Octagon	Laminate	Painted	30 W x 21 D in	Specify	Specify	6-1441894-670	\$246.95	6-1576478-670	Specify	\$279.95
Octagon	Laminate	T-Mold	30 W x 21 D in	Specify	Specify	6-5009407-670	\$246.95	6-5009355-670	Specify	\$279.95
Octagon	Hard Plastic	—	30 W x 21 D in	Specify	—	6-1441893-670	\$272.95	6-1576480-670	Specify	\$306.95
Octagon	Laminate	LockEdge	30 W x 21 D in	Specify	Specify	6-1441896-670	\$279.95	6-1576479-670	Specify	\$312.95

Top Shape	Top Type	Edge Type	Top Dimensions	Top Color	Edge Color	Without Book Box		With Book Box		
						Item #	List Price	Item #	Book Box Type	List Price
<b>Fixed Height 30" with 2 Casters</b>										
Rectangle	Laminate	Painted	26 W x 20 D in	Specify	Specify	6-5002648-670	\$266.95	6-5002655-670	Specify	\$299.95
Rectangle	Laminate	T-Mold	26 W x 20 D in	Specify	Specify	6-5009415-670	\$266.95	6-5009358-670	Specify	\$299.95
Rectangle	Hard Plastic	—	26 W x 20 D in	Specify	—	6-5002670-670	\$292.95	6-5002685-670	Specify	\$326.95
Rectangle	Laminate	LockEdge	26 W x 20 D in	Specify	Specify	6-5002637-670	\$299.95	6-5002654-670	Specify	\$332.95
Triangle	Laminate	Painted	36 W x 24 D in	Specify	Specify	6-5002663-670	\$279.95	6-5002617-670	Specify	\$312.95
Triangle	Laminate	T-Mold	36 W x 24 D in	Specify	Specify	6-5009403-670	\$279.95	6-5009354-670	Specify	\$312.95
Triangle	Hard Plastic	—	36 W x 24 D in	Specify	—	6-5002692-670	\$306.95	6-5002698-670	Specify	\$339.95
Triangle	Laminate	LockEdge	36 W x 24 D in	Specify	Specify	6-5002535-670	\$312.95	6-5002604-670	Specify	\$346.95
Hexagon	Laminate	Painted	33 W x 21 D in	Specify	Specify	6-5002618-670	\$279.95	6-5002633-670	Specify	\$312.95
Hexagon	Laminate	T-Mold	33 W x 21 D in	Specify	Specify	6-5009396-670	\$279.95	6-5009359-670	Specify	\$312.95
Hexagon	Hard Plastic	—	33 W x 21 D in	Specify	—	6-5002677-670	\$306.95	6-5002684-670	Specify	\$339.95
Hexagon	Laminate	LockEdge	33 W x 21 D in	Specify	Specify	6-5002629-670	\$312.95	6-5002668-670	Specify	\$346.95
Octagon	Laminate	Painted	30 W x 21 D in	Specify	Specify	6-5002591-670	\$279.95	6-5002615-670	Specify	\$312.95
Octagon	Laminate	T-Mold	30 W x 21 D in	Specify	Specify	6-5009401-670	\$279.95	6-5009352-670	Specify	\$312.95
Octagon	Hard Plastic	—	30 W x 21 D in	Specify	—	6-5002691-670	\$306.95	6-5002701-670	Specify	\$339.95
Octagon	Laminate	LockEdge	30 W x 21 D in	Specify	Specify	6-5002620-670	\$312.95	6-5002609-670	Specify	\$346.95

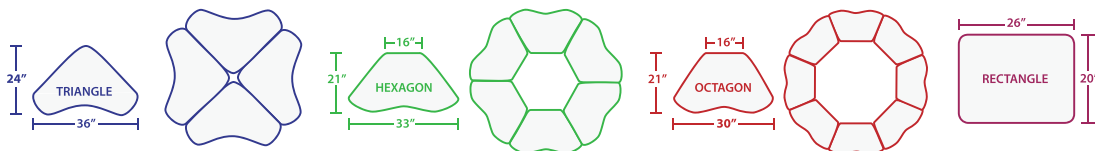



**CLASSROOM  
SELECT** 

**LIMITED  
WARRANTY**

**GREENGUARD  
GOLD**

PRODUCT CERTIFIED  
FOR LOW CHEMICAL  
EMISSIONS:  
UL.COM/IGG  
UL 2818

**PLEASE  
SPECIFY  
COLOR  
CHOICE**

Refer to pages 60-61  
for color options.



Shown with optional  
wire book rack

**Classroom Select® Contemporary Collaboration Adjustable Height Desks**

Create an ideal learning environment for collaboration and classroom flexibility. The unique design helps create a classroom that can be grouped together or worked individually. Desks are available in laminate with a painted edge, laminate with LockEdge®, or hard plastic tops; all feature a full nickel chrome frame finish. Leg height is adjustable from 22" to 33" for added flexibility. Select from an optional chrome wire book rack or black metal book box to accommodate all storage needs. Available with or without 2 lockable casters.

**Quickship available, without book rack or book box or without casters, in the following top color options: Gray Nebula, Fusion Maple, Bannister Oak or Nepal Teak for laminate. Light Gray, Beach (Beige) or Sugar Maple for Hard Plastic.**

Top Shape	Top Type	Edge Type	Top Dimensions	Top Color	Edge Color	Without Book Box		With Book Box		
						Item #	List Price	Item #	Book Box Type	List Price
<b>Adjustable Height 22-33 in without Casters</b>										
Rectangle	Laminate	Painted	26 W x 20 D in	Specify	Specify	6-1554999-670	\$246.95	6-1576487-670	Specify	\$279.95
Rectangle	Laminate	T-Mold	26 W x 20 D in	Specify	Specify	6-5009399-670	\$246.95	6-5009365-670	Specify	\$279.95
Rectangle	Hard Plastic	-	26 W x 20 D in	Specify	-	6-1555000-670	\$272.95	6-1576488-670	Specify	\$306.95
Rectangle	Laminate	LockEdge	26 W x 20 D in	Specify	Specify	6-1555001-670	\$279.95	6-1576489-670	Specify	\$312.95
Triangle	Laminate	Painted	36 W x 24 D in	Specify	Specify	6-1425933-670	\$259.95	6-1576469-670	NEW	Specify \$292.95
Triangle	Laminate	T-Mold	36 W x 24 D in	Specify	Specify	6-5009392-670	\$259.95	6-5009343-670	Specify	\$292.95
Triangle	Hard Plastic	-	36 W x 24 D in	Specify	-	6-1425930-670	\$286.95	6-1576471-670	NEW	Specify \$319.95
Triangle	Laminate	LockEdge	36 W x 24 D in	Specify	Specify	6-1426975-670	\$292.95	6-1576470-670	Specify	\$326.95
Hexagon	Laminate	Painted	33 W x 21 D in	Specify	Specify	6-1441899-670	\$259.95	6-1576475-670	NEW	Specify \$292.95
Hexagon	Laminate	T-Mold	33 W x 21 D in	Specify	Specify	6-5009420-670	\$259.95	6-5009357-670	Specify	\$292.95
Hexagon	Hard Plastic	-	33 W x 21 D in	Specify	-	6-1441897-670	\$286.95	6-1576477-670	NEW	Specify \$319.95
Hexagon	Laminate	LockEdge	33 W x 21 D in	Specify	Specify	6-1441901-670	\$292.95	6-1576476-670	Specify	\$326.95
Octagon	Laminate	Painted	30 W x 21 D in	Specify	Specify	6-1441900-670	\$259.95	6-1576481-670	Specify	\$292.95
Octagon	Laminate	T-Mold	30 W x 21 D in	Specify	Specify	6-5009412-670	\$259.95	6-5009361-670	Specify	\$292.95
Octagon	Hard Plastic	-	30 W x 21 D in	Specify	-	6-1441898-670	\$286.95	6-1576483-670	Specify	\$319.95
Octagon	Laminate	LockEdge	30 W x 21 D in	Specify	Specify	6-1441902-670	\$292.95	6-1576482-670	Specify	\$326.95
<b>Adjustable Height 22-33 in with 2 Casters</b>										
Rectangle	Laminate	Painted	26 W x 20 D in	Specify	Specify	6-5002614-670	\$279.95	6-5002646-670	Specify	\$312.95
Rectangle	Laminate	T-Mold	26 W x 20 D in	Specify	Specify	6-5009414-670	\$279.95	6-5009353-670	Specify	\$312.95
Rectangle	Hard Plastic	-	26 W x 20 D in	Specify	-	6-5002696-670	\$306.95	6-5002680-670	Specify	\$339.95
Rectangle	Laminate	LockEdge	26 W x 20 D in	Specify	Specify	6-5002658-670	\$312.95	6-5002623-670	Specify	\$346.95
Triangle	Laminate	Painted	36 W x 24 D in	Specify	Specify	6-5002602-670	\$292.95	6-5002638-670	NEW	Specify \$326.95
Triangle	Laminate	T-Mold	36 W x 24 D in	Specify	Specify	6-5009417-670	\$292.95	6-5009350-670	Specify	\$326.95
Triangle	Hard Plastic	-	36 W x 24 D in	Specify	-	6-5002679-670	\$319.95	6-5002690-670	NEW	Specify \$352.95
Triangle	Laminate	LockEdge	36 W x 24 D in	Specify	Specify	6-5002661-670	\$326.95	6-5002585-670	Specify	\$359.95
Hexagon	Laminate	Painted	33 W x 21 D in	Specify	Specify	6-5002631-670	\$292.95	6-5002634-670	NEW	Specify \$326.95
Hexagon	Laminate	T-Mold	33 W x 21 D in	Specify	Specify	6-5009409-670	\$292.95	6-5009362-670	Specify	\$326.95
Hexagon	Hard Plastic	-	33 W x 21 D in	Specify	-	6-5002686-670	\$319.95	6-5002693-670	NEW	Specify \$352.95
Hexagon	Laminate	LockEdge	33 W x 21 D in	Specify	Specify	6-5002616-670	\$326.95	6-5002636-670	Specify	\$359.95
Octagon	Laminate	Painted	30 W x 21 D in	Specify	Specify	6-5002667-670	\$292.95	6-5002624-670	Specify	\$326.95
Octagon	Laminate	T-Mold	30 W x 21 D in	Specify	Specify	6-5009406-670	\$292.95	6-5009351-670	Specify	\$326.95
Octagon	Hard Plastic	-	30 W x 21 D in	Specify	-	6-5002675-670	\$319.95	6-5002700-670	Specify	\$352.95
Octagon	Laminate	LockEdge	30 W x 21 D in	Specify	Specify	6-5002641-670	\$326.95	6-5002665-670	Specify	\$359.95



PRODUCT CERTIFIED FOR LOW CHEMICAL EMISSIONS  
UL.COM/IGG  
UL 2818



Refer to pages 60-61 for color options.



Two Student Desk 60" x 24"

Optional Technology Basket sold separately



Single Student Desk

**Classroom Select® Advocate Series® Four Leg Desk**

The perfect solution for a conventional classroom environment. The Advocate Series® Four Leg Desk allows you to choose from 4 top size options to accommodate independent learning or multi-student collaboration. Solid 1" 14-gauge square tube steel legs adjust from 24"-34" adding durability to any elementary through high school setting. Frame features an integrated back pack hook on both sides. Vinyl T-Mold edge is available on 1-1/8" particleboard. Colored LockEdge® is a sprayed on polyurethane edge on a 1-1/8" MDF top, providing increased durability. Available with a metal book box or wire book rack, or sliding tote rails that will fit the Geode Series® Storage tote trays, sold separately. Purchase the Classroom Select® Technology Basket for a simple storage solution for up to 14" laptops or tablets, sold separately.

Product Dimensions	Top Type	Edge Type	Edge Color	Frame Color	BookBox Type	Laminate / Hard Plastic Top			Markerboard Top	
						Item #	Top Color	List Price	Item #	List Price
<b>Single Student Desk</b>										
26 W x 20 D in	Hard Plastic	—	—	Titanium	—	6-5002697-670	Specify	\$319.95	—	—
26 W x 20 D in	Laminate	T-mold	Specify	Titanium	—	6-5002503-670	Specify	\$332.95	6-5002527-670	\$366.95
26 W x 20 D in	Laminate	LockEdge	Specify	Titanium	—	6-5002505-670	Specify	\$366.95	6-5004831-670	\$399.95
<b>Single Student Desk with Tote Rails</b>										
26 W x 20 D in	Hard Plastic	—	—	Titanium	—	6-5002671-670	Specify	\$452.95	—	—
26 W x 20 D in	Laminate	T-mold	Specify	Titanium	—	6-5002515-670	Specify	\$466.95	6-5002497-670	\$499.95
26 W x 20 D in	Laminate	LockEdge	Specify	Titanium	—	6-5002512-670	Specify	\$499.95	6-5004832-670	\$532.95
<b>Single Student Desk with Book Box</b>										
26 W x 20 D in	Hard Plastic	—	—	Titanium	Specify	6-5002699-670	Specify	\$386.95	—	—
26 W x 20 D in	Laminate	T-mold	Specify	Titanium	Specify	6-5002495-670	Specify	\$399.95	6-5002511-670	\$432.95
26 W x 20 D in	Laminate	LockEdge	Specify	Titanium	Specify	6-5002500-670	Specify	\$432.95	6-5002499-670	\$466.95
<b>Two Student Desk</b>										
48 W x 20 D in	Laminate	T-mold	Specify	Titanium	—	6-5002526-670	Specify	\$399.95	6-5002517-670	\$432.95
48 W x 20 D in	Laminate	LockEdge	Specify	Titanium	—	6-5002524-670	Specify	\$432.95	6-5004833-670	\$466.95
60 W x 24 D in	Laminate	T-mold	Specify	Titanium	—	6-5002530-670	Specify	\$466.95	6-5002509-670	\$499.95
60 W x 24 D in	Laminate	LockEdge	Specify	Titanium	—	6-5002553-670	Specify	\$499.95	6-5004834-670	\$532.95
72 W x 24 D in	Laminate	T-mold	Specify	Titanium	—	6-5002576-670	Specify	\$532.95	6-5002584-670	\$566.95
72 W x 24 D in	Laminate	LockEdge	Specify	Titanium	—	6-5002619-670	Specify	\$566.95	6-5004835-670	\$599.95
<b>Two Student Desk with Two Sets of Tote Rails</b>										
48 W x 20 D in	Laminate	T-mold	Specify	Titanium	—	6-5002516-670	Specify	\$499.95	6-5002531-670	\$532.95
48 W x 20 D in	Laminate	LockEdge	Specify	Titanium	—	6-5002555-670	Specify	\$532.95	6-5004836-670	\$566.95
60 W x 24 D in	Laminate	T-mold	Specify	Titanium	—	6-5002595-670	Specify	\$566.95	6-5002573-670	\$599.95
60 W x 24 D in	Laminate	LockEdge	Specify	Titanium	—	6-5002545-670	Specify	\$599.95	6-5004837-670	\$632.95
72 W x 24 D in	Laminate	T-mold	Specify	Titanium	—	6-5002593-670	Specify	\$632.95	6-5002543-670	\$666.95
72 W x 24 D in	Laminate	LockEdge	Specify	Titanium	—	6-5002599-670	Specify	\$666.95	6-5004838-670	\$699.95
<b>Two Student Desk with Two Book Boxes</b>										
48 W x 20 D in	Laminate	T-mold	Specify	Titanium	Specify	6-5002496-670	Specify	\$466.95	6-5002539-670	\$499.95
48 W x 20 D in	Laminate	LockEdge	Specify	Titanium	Specify	6-5002519-670	Specify	\$499.95	6-5002507-670	\$532.95
60 W x 24 D in	Laminate	T-mold	Specify	Titanium	Specify	6-5002522-670	Specify	\$532.95	6-5002536-670	\$566.95
60 W x 24 D in	Laminate	LockEdge	Specify	Titanium	Specify	6-5002571-670	Specify	\$566.95	6-5002528-670	\$599.95
72 W x 24 D in	Laminate	T-mold	Specify	Titanium	Specify	6-5002608-670	Specify	\$599.95	6-5002510-670	\$632.95
72 W x 24 D in	Laminate	LockEdge	Specify	Titanium	Specify	6-5002533-670	Specify	\$632.95	6-5002518-670	\$666.95

Item #	Description	List Price
9-2027667-670	3 in Tote Tray	\$17.95
9-5002704-670	Technology Basket	\$31.95
9-2040212-670	Table Casters - Set of 4	\$30.95

**See Page 253-256 For Compatible Geode Series® Storage Options**



Refer to pages 60-61 for color options.



PRODUCT CERTIFIED FOR LOW CHEMICAL EMISSIONS: UL.COM/IGG UL 2818



Single Student Desk



Two Student Desk 60" x 24"



Desk shown with optional tote rails that are compatible with the Classroom Select® Geode Series® storage totes. See pages 253-256 for storage options

### Classroom Select® Advocate Series® Pedestal Leg Desk

Put your students front and center with the Classroom Select® Advocate Series® Four Leg/Pedestal Leg Desk. Choose from single-student or two-student units offered in four top size options to best fit your space. 4 durable 14-gauge steel legs or 4 15-gauge steel pedestal legs attached to a 10-gauge steel mounting plate provide a sturdy work surface for maximum student engagement. 4 Legs adjust from 24" to 34" height range, on 1" increments. Vinyl T-Mold edge is available on 1-1/8" particleboard. Colored LockEdge® is a sprayed on polyurethane edge on a 1-1/8" MDF top, providing increased durability. Compatible with 3" tote trays, sold separately. Purchase the Classroom Select® Technology Basket in black or titanium for a simple storage solution for up to 14" laptops or tablets, sold separately.

Product Dimensions	Top Type	Edge Type	Edge Color	Frame Color	BookBox Type	Laminate / Hard Plastic Top			Markerboard Top	
						Item #	Top Color	List Price	Item #	List Price
<b>Single Student Desk</b>										
26 W x 20 D in	Hard Plastic	—	—	Titanium	—	6-5002673-670	Specify	\$319.95	—	—
26 W x 20 D in	Laminate	T-mold	Specify	Titanium	—	6-5002579-670	Specify	\$332.95	6-5002537-670	\$366.95
26 W x 20 D in	Laminate	LockEdge	Specify	Titanium	—	6-5002587-670	Specify	\$366.95	6-5004839-670	\$399.95
<b>Single Student Desk with Tote Rails</b>										
26 W x 20 D in	Hard Plastic	—	—	Titanium	—	6-5002687-670	Specify	\$452.95	—	—
26 W x 20 D in	Laminate	T-mold	Specify	Titanium	—	6-5002541-670	Specify	\$466.95	6-5002613-670	\$499.95
26 W x 20 D in	Laminate	LockEdge	Specify	Titanium	—	6-5002660-670	Specify	\$499.95	6-5004840-670	\$532.95
<b>Single Student Desk with Book Box</b>										
26 W x 20 D in	Hard Plastic	—	—	Titanium	Specify	6-5002695-670	Specify	\$386.95	—	—
26 W x 20 D in	Laminate	T-mold	Specify	Titanium	Specify	6-5002513-670	Specify	\$399.95	6-5002554-670	\$432.95
26 W x 20 D in	Laminate	LockEdge	Specify	Titanium	Specify	6-5002556-670	Specify	\$432.95	6-5002578-670	\$466.95
<b>Two Student Desk</b>										
48 W x 20 D in	Laminate	T-mold	Specify	Titanium	—	6-5002561-670	Specify	\$399.95	6-5002563-670	\$432.95
48 W x 20 D in	Laminate	LockEdge	Specify	Titanium	—	6-5002600-670	Specify	\$432.95	6-5004841-670	\$466.95
60 W x 24 D in	Laminate	T-mold	Specify	Titanium	—	6-5002653-670	Specify	\$466.95	6-5002635-670	\$499.95
60 W x 24 D in	Laminate	LockEdge	Specify	Titanium	—	6-5002639-670	Specify	\$499.95	6-5004842-670	\$532.95
72 W x 24 D in	Laminate	T-mold	Specify	Titanium	—	6-5002666-670	Specify	\$532.95	6-5002523-670	\$566.95
72 W x 24 D in	Laminate	LockEdge	Specify	Titanium	—	6-5002625-670	Specify	\$566.95	6-5004843-670	\$599.95
<b>Two Student Desk with Two Sets of Tote Rails</b>										
48 W x 20 D in	Laminate	T-mold	Specify	Titanium	—	6-5002650-670	Specify	\$499.95	6-5002565-670	\$532.95
48 W x 20 D in	Laminate	LockEdge	Specify	Titanium	—	6-5002644-670	Specify	\$532.95	6-5004844-670	\$566.95
60 W x 24 D in	Laminate	T-mold	Specify	Titanium	—	6-5002558-670	Specify	\$566.95	6-5002649-670	\$599.95
60 W x 24 D in	Laminate	LockEdge	Specify	Titanium	—	6-5002664-670	Specify	\$599.95	6-5004845-670	\$632.95
72 W x 24 D in	Laminate	T-mold	Specify	Titanium	—	6-5002626-670	Specify	\$632.95	6-5002551-670	\$666.95
72 W x 24 D in	Laminate	LockEdge	Specify	Titanium	—	6-5002610-670	Specify	\$666.95	6-5004846-670	\$699.95
<b>Two Student Desk with Two Book Boxes</b>										
48 W x 20 D in	Laminate	T-mold	Specify	Titanium	Specify	6-5002574-670	Specify	\$466.95	6-5002627-670	\$499.95
48 W x 20 D in	Laminate	LockEdge	Specify	Titanium	Specify	6-5002583-670	Specify	\$499.95	6-5002544-670	\$532.95
60 W x 24 D in	Laminate	T-mold	Specify	Titanium	Specify	6-5002567-670	Specify	\$532.95	6-5002642-670	\$566.95
60 W x 24 D in	Laminate	LockEdge	Specify	Titanium	Specify	6-5002656-670	Specify	\$566.95	6-5002645-670	\$599.95
72 W x 24 D in	Laminate	T-mold	Specify	Titanium	Specify	6-5002652-670	Specify	\$599.95	6-5002590-670	\$632.95
72 W x 24 D in	Laminate	LockEdge	Specify	Titanium	Specify	6-5002647-670	Specify	\$632.95	6-5002658-670	\$666.95

Item #	Description	List Price
9-2027667-670	3 in Tote Tray	\$17.95
9-2038890-670	Backpack Hook	\$7.25

Item #	Description	List Price
9-5002704-670	Technology Basket	\$31.95
9-2040212-670	Table Casters - Set of 4	\$30.95





PRODUCT CERTIFIED FOR LOW CHEMICAL EMISSIONS: UL.COM/IGG UL 2918



Refer to pages 60-61 for color options.

### Classroom Select® Contemporary Cantilever Desk

The Contemporary design Cantilever Desk is highlighted by two arched bars that run from leg to leg for added support and stylish appearance. Frame is available in full nickel chrome, titanium powdercoat, or black powdercoat finish. Desktops available in 26" x 20" hard plastic, high pressure laminate, or markerboard; laminate tops come with your choice of colored LockEdge®, T-Mold edge, or painted edge in beige or titanium. 29-1/2" fixed height. Assembled.

Top Type	Top Color	Edge Type	Edge Color	Chrome Frame		Specify Frame	
				Item #	List Price	Item #	List Price
Laminate <b>NEW</b>	Specify	Painted	Specify	6-1388737-670	\$246.95	6-1496551-670	\$232.95
Laminate <b>NEW</b>	Specify	T-Mold	Specify	6-5009402-670	\$246.95	6-5009418-670	\$232.95
Hard Plastic	Specify	-	-	6-1388739-670	\$272.95	6-1496552-670	\$259.95
Laminate	Specify	LockEdge	Specify	6-1426973-670	\$279.95	6-1496553-670	\$266.95
Markerboard <b>NEW</b>	White	Painted	Specify	6-5009584-670	\$279.95	6-5009588-670	\$266.95
Markerboard <b>NEW</b>	White	T-Mold	Specify	6-5009585-670	\$279.95	6-5009589-670	\$266.95
Markerboard <b>NEW</b>	White	LockEdge	Specify	6-5009587-670	\$309.95	6-5009591-670	\$296.95

Item #	Description	List Price
9-1511985-670	Chrome Book Bag Hook	\$16.95
9-1511986-670	Black Book Bag Hook	\$16.95



Book Bag Hook



Black Book Bag Hook



### Classroom Select® NeoClass® Elliptical Cantilever Desk

Some environments require stability and flexibility while still providing an ample work surface. Compliment your NeoClass® Elliptical Cantilever Chair with this designer-friendly, versatile desk. Modern elliptical base frame is available in chrome, black powdercoat, or titanium powdercoat. Desktops available in 26" x 20" hard plastic or high pressure laminate fitted on 14-gauge steel 29" high frame; laminate tops come with your choice of colored LockEdge®, T-Mold edge, or painted edge in beige or titanium. Assembled.

Top	Top Color	Edge Type	Edge Color	Chrome Frame		Specify Frame	
				Item #	List Price	Item #	List Price
Laminate <b>NEW</b>	Specify	Painted	Specify	6-1502998-670	\$272.95	6-1503001-670	\$259.95
Laminate <b>NEW</b>	Specify	T-Mold	Specify	6-5009398-670	\$272.95	6-5009410-670	\$259.95
Hard Plastic	Specify	-	-	6-1502999-670	\$299.95	6-1503002-670	\$286.95
Laminate	Specify	LockEdge	Specify	6-1503000-670	\$306.95	6-1503003-670	\$292.95
Markerboard <b>NEW</b>	White	Painted	Specify	6-5009598-670	\$306.95	6-5009602-670	\$292.95
Markerboard <b>NEW</b>	White	T-Mold	Specify	6-5009599-670	\$306.95	6-5009603-670	\$292.95
Markerboard <b>NEW</b>	White	LockEdge	Specify	6-5009601-670	\$336.95	6-5009605-670	\$322.95



### Classroom Select® Contemporary Elliptical Lift Lid Desk

The Classroom Select® Contemporary Elliptical Lift Lid Desk features a 24" x 18" top on a 19-gauge, 5 1/2" deep metal book box with 16-gauge side panels. A direct access pencil tray allows for quick access without opening, and a no-pinch front lift lid design protects fingers from being pinched when closed. The all welded frame and legs consist of two 2" x 1-1/4", 13-gauge upright oval steel tubes with two 2" x 1-1/4", 13-gauge cross tube welded to mid section of leg assembly to provide strength and stability. Adjustable legs range from 22" to 30" in height. Desktops available in either hard plastic or high pressure laminate; laminate tops come with your choice of colored LockEdge®, T-Mold edge, or painted edge in beige or titanium. Assembled.

Top Type	Top Color	Edge Color	18 x 24 in Top Size	
			Item #	List Price
Laminate	Specify	Painted	6-1527644-670	\$332.95
Laminate	Specify	Specify	6-5009411-670	\$332.95
Hard Plastic	Specify	-	6-1527645-670	\$359.95
Laminate with LockEdge	Specify	Specify	6-1527643-670	\$366.95



### Classroom Select® Traditional F500 Open Front Desk

This traditional classroom desk features a large 24 x 20" laminate top with convenient storage for books, pencils, and other supplies. Desktop is available in 5/8" MDF laminate with a urethane painted edge or particleboard laminate top with T-Mold edge. The desk is height adjustable from 22-1/2" to 33-1/2". Leg Inserts are full nickel chrome and leg uppers have a black powdercoat finish.

Item #	Top Type	Top Size	Edge Type	Top Color	Bookbox Color	Edge Color	List Price
6-5008959-670	Laminate	24x20	Painted	Specify	Black	Specify	\$146.95
6-5009424-670	Laminate	24x20	T-Mold	Specify	Black	Specify	\$146.95



Refer to pages 60-61 for color options.

### Classroom Select® Contemporary Open Front Desk

The Classroom Select® Contemporary Open Front Desk features an attractive polypropylene book box for structural reliability. Available with an 24" x 18" and 26" x 20" A+ hard plastic top or an 24" x 18" and 26" x 20" A+ laminate top that has a 3/16" thick MDF core surfaced with a high-pressure laminate and a phenolic paper backer to minimize warping. The edges are sealed with polyurethane. The frame has 18-gauge steel black powdercoated uppers with 16-gauge full chrome inserts which are adjustable at 1" intervals from 22" to 31" or 22" to 33" for the larger A+ size. The inserts are securely attached with a locking system that prevents the legs from being removed and feature self-leveling glides. **Please order in carton quantities of 2.** \*The Traditional Series A+ size chairs are compatible with the 26" x 20" A+ size desk only.

**Quickship available with black book box and your choice of the following top color options: Gray Nebula, Fusion Maple, Bannister Oak or Nepal Teak for laminate. Light Gray, Beach (Beige) or Sugar Maple for Hard Plastic.**



Top Type	Edge Type	Top Color	Edge Color	Book Box Color	24 W x 18 D in Top Size		26 W x 20 D in A+ Top Size	
					Item #	List Price	Item #	List Price
Laminate	Painted	Specify	Specify	Specify	6-1357327-670	\$146.95	6-1441883-670	\$166.95
Laminate	<b>NEW</b> T-Mold	Specify	Specify	Specify	6-5009340-670	\$146.95	6-5009364-670	\$166.95
Hard Plastic	-	Specify	-	Specify	6-1388734-670	\$172.95	6-1441885-670	\$192.95
Laminate	LockEdge	Specify	Specify	Specify	6-1426979-670	\$179.95	6-1441884-670	\$199.95
Markerboard	<b>NEW</b> Painted	White	Specify	Specify	6-5009576-670	\$179.95	6-5009580-670	\$199.95
Markerboard	<b>NEW</b> T-Mold	White	Specify	Specify	6-5009577-670	\$179.95	6-5009581-670	\$199.95
Markerboard	<b>NEW</b> LockEdge	White	Specify	Specify	6-5009579-670	\$209.95	6-5009582-670	\$229.95

### Classroom Select® Traditional Open Front Desk

This traditional classroom desk features a laminate work surface that includes convenient storage for books, pencils, and other supplies. The book box is dye pressed and includes a pencil tray with embossing strips along the bottom and back. It is available in a black powdercoat finish and is height adjustable from 22-1/2" to 30" or 22-1/2" to 33-1/2" for the larger A+ size. Leg inserts are in full nickel chrome and uppers in a black powdercoat finish. Desktops are available in either 18" x 24" or 20" x 26" hard plastic or high pressure laminate. Laminate tops come with your choice of colored LockEdge®, T-Mold edge, or painted edge in beige or titanium. The Traditional Series A+ size and Royal Seating® 18" hard plastic chairs are compatible with the A+ size desk only. **Please order in carton quantities of two.**

**Quickship available with your choice of the following top color options: Gray Nebula, Fusion Maple, Bannister Oak or Nepal Teak for laminate. Light Gray, Beach (Beige) or Sugar Maple for Hard Plastic.**



Top Type	Edge Type	Top Color	Edge Color	Book Box Color	24 W x 18 D in Top Size		26 W x 20 D in A+ Top Size	
					Item #	List Price	Item #	List Price
Laminate	Painted	Specify	Specify	Specify	6-1357320-670	\$132.95	6-1441874-670	\$152.95
Laminate	<b>NEW</b> T-Mold	Specify	Specify	Specify	6-5009342-670	\$132.95	6-5009336-670	\$152.95
Hard Plastic	-	Specify	-	Specify	6-1388952-670	\$159.95	6-1441876-670	\$179.95
Laminate	LockEdge	Specify	Specify	Specify	6-1426982-670	\$166.95	6-1441875-670	\$186.95

### Classroom Select® Royal Seating® 1800A Student Executive Desk

Desktops available in either hard plastic or laminate; laminate tops come with your choice of colored LockEdge®, T-Mold edge, or painted edge in beige or titanium. Book compartment is slanted to keep books upright. Modesty panel is an integral part of the structure. Desk is adjustable from 22-1/2" to 33-1/2" in 1" increments. Black frame with chrome inserts.



Top Type	Top Size	Edge Type	Top Color	Edge Color	With Right Side Book Box		With Left Side Book Box	
					Item #	List Price	Item #	List Price
Laminate	<b>NEW</b> 36 W x 20 D in	Painted	Specify	Specify	6-5009944-670	\$272.95	6-5009939-670	\$272.95
Laminate	36 W x 20 D in	T-Mold	Specify	Specify	6-1503604-670	\$272.95	6-1503605-670	\$272.95
Hard Plastic	36 W x 20 D in	-	Specify	-	6-1503606-670	\$299.95	6-1503607-670	\$299.95
Laminate	36 W x 20 D in	LockEdge	Specify	Specify	6-1508339-670	\$306.95	6-1508338-670	\$306.95

### Classroom Select® Royal Seating® 1600 Open Front Desk

Featuring a wide opening that allows more leg room for oversized chairs, the U-shaped leg frame connects directly to an open front desktop for optimum support. Desktops available in either hard plastic or laminate; laminate tops come with your choice of colored LockEdge®, T-Mold edge, or painted edge in beige or titanium. Select from 24" x 18", 26" x 20" A+, or the ADA compliant 36" x 20" sizes. The legs are height adjustable from 22-1/2" to 30-1/2", or 22-1/2" to 33-1/2" for the larger A+ and ADA compliant sizes. The one-piece metal or plastic book box measures 20-1/2"W x 15"D x 4-1/2"H. **Please order in carton quantities of 2.**

**Quickship available with metal book box in your choice of the following top color options: Gray Nebula, Fusion Maple, Bannister Oak or Nepal Teak for laminate with T-Mold. Light Gray, Beach (Beige) or Sugar Maple for Hard Plastic.**



Top Type	Top Size	Edge Type	Top Color	Edge Color	Metal Book Box		Plastic Book Box	
					Item #	List Price	Item #	List Price
Laminate	<b>NEW</b> 24 W x 18 D in	Painted	Specify	Specify	6-5009937-670	\$159.95	6-5009942-670	\$146.95
Laminate	24 W x 18 D in	T-Mold	Specify	Specify	6-1362401-670	\$159.95	6-1458256-670	\$146.95
Hard Plastic	24 W x 18 D in	-	Specify	-	6-1363853-670	\$186.95	6-1435484-670	\$172.95
Laminate	24 W x 18 D in	LockEdge	Specify	Specify	6-1496598-670	\$192.95	6-1496594-670	\$179.95
Laminate	<b>NEW</b> 26 W x 20 D in A+	Painted	Specify	Specify	6-5009936-670	\$179.95	6-5009938-670	\$166.95
Laminate	26 W x 20 D in A+	T-Mold	Specify	Specify	6-1496599-670	\$179.95	6-1496595-670	\$166.95
Hard Plastic	26 W x 20 D in A+	-	Specify	-	6-1496600-670	\$206.95	6-1496596-670	\$192.95
Laminate	26 W x 20 D in A+	LockEdge	Specify	Specify	6-1496601-670	\$212.95	6-1496597-670	\$199.95
Laminate	<b>NEW</b> 36 W x 20 D in ADA	Painted	Specify	Specify	6-5009946-670	\$206.95	-	-
Laminate	36 W x 20 D in ADA	T-Mold	Specify	Specify	6-5002707-670	\$206.95	-	-
Hard Plastic	36 W x 20 D in ADA	-	Specify	-	6-5002714-670	\$226.95	-	-
Laminate	36 W x 20 D in ADA	LockEdge	Specify	Specify	6-5002708-670	\$232.95	-	-

**24-hr Quickship** available for item 1363853 with Beach (Beige) hard plastic top in quantities of up to 32 each. Applies to orders containing 24 hour quickship items only.

**PLEASE SPECIFY COLOR CHOICE**  
Refer to pages 60-61 for color options.



PRODUCT CERTIFIED FOR LOW CHEMICAL EMISSIONS: UL.COM/CGG UL 2818

**CLASSROOM SELECT**



Shown with optional Patented Fidget Pedal



Shown without Tilt-N-Nest®, with Book Box

**Classroom Select® 30 Inch Fixed Height Desk**

The Classroom Select® 30 inch Fixed Height Desk is an easy to move desk that is perfect for the 21st century learning environment. The Tilt-N-Nest® model includes a simple lever release that allows the top to be folded down, with the desk then nestable for easy storage. The collaborative design with two casters, four stabilizing glides, and desktops that group together, allow students to work together in pods no matter the classroom set-up. The tabletop is made of 1-1/8" particleboard core with a high pressure laminate top and T-Mold edge. Available to order with a unique adjustable fidget pedal which promotes natural movement and enhances student focus which can be used sitting or standing. Desks with fidget pedal do not nest. Fixed height desks without the Tilt-N-Nest® feature are offered with a book box for added storage. Assembled.

Top Shape	Top Type	Top Color	Edge Color	Product Dimensions	Without Tilt-N-Nest®		With Tilt-N-Nest®		Without Tilt-N-Nest®, With Book Box	
					Item #	List Price	Item #	List Price	Item #	List Price
<b>T-Mold Edge</b>										
Harmony	Laminate	Specify	Specify	33-1/2"W x 25-1/2"D in	6-5008697-670	\$446.95	6-5008717-670	\$479.95	6-5008810-670	\$479.95
Harmony	Markerboard	White	Specify	33-1/2"W x 25-1/2"D in	6-5008663-670	\$479.95	6-5008702-670	\$512.95	6-5008814-670	\$512.95
Affinity	Laminate	Specify	Specify	34-1/4"W x 23-1/2"D in	6-5008696-670	\$446.95	6-5008731-670	\$479.95	6-5008826-670	\$479.95
Affinity	Markerboard	White	Specify	34-1/4"W x 23-1/2"D in	6-5008691-670	\$479.95	6-5008719-670	\$512.95	6-5008830-670	\$512.95
Bond	Laminate	Specify	Specify	28W x 24D in	6-5008728-670	\$446.95	6-5008729-670	\$479.95	6-5008818-670	\$479.95
Bond	Markerboard	White	Specify	28W x 24D in	6-5008678-670	\$479.95	6-5008690-670	\$512.95	6-5008822-670	\$646.95
Gem Alliance	Laminate	Specify	Specify	33W x 23-3/4D in	6-5008664-670	\$446.95	6-5008727-670	\$479.95	6-5008835-670	\$479.95
Gem Alliance	Markerboard	White	Specify	33W x 23-3/4D in	6-5008679-670	\$479.95	6-5008706-670	\$512.95	6-5008838-670	\$512.95
<b>T-Mold Edge with Fidget Pedal</b>										
Harmony	Laminate	Specify	Specify	33-1/2"W x 25-1/2"D in	6-5008668-670	\$579.95	6-5008726-670	\$612.95	6-5008809-670	\$612.95
Harmony	Markerboard	White	Specify	33-1/2"W x 25-1/2"D in	6-5008667-670	\$612.95	6-5008707-670	\$646.95	6-5008813-670	\$646.95
Affinity	Laminate	Specify	Specify	34-1/4"W x 23-1/2"D in	6-5008675-670	\$579.95	6-5008695-670	\$612.95	6-5008825-670	\$612.95
Affinity	Markerboard	White	Specify	34-1/4"W x 23-1/2"D in	6-5008684-670	\$612.95	6-5008703-670	\$646.95	6-5008828-670	\$646.95
Bond	Laminate	Specify	Specify	28W x 24D in	6-5008677-670	\$579.95	6-5008715-670	\$612.95	6-5008817-670	\$612.95
Bond	Markerboard	White	Specify	28W x 24D in	6-5008688-670	\$612.95	6-5008708-670	\$646.95	6-5008821-670	\$512.95
Gem Alliance	Laminate	Specify	Specify	33W x 23-3/4D in	6-5008681-670	\$579.95	6-5008713-670	\$612.95	6-5008833-670	\$612.95
Gem Alliance	Markerboard	White	Specify	33W x 23-3/4D in	6-5008683-670	\$612.95	6-5008709-670	\$646.95	6-5008834-670	\$646.95
<b>LockEdge®</b>										
Harmony	Laminate	Specify	Specify	33-1/2"W x 25-1/2"D in	6-5008662-670	\$479.95	6-5008714-670	\$512.95	6-5008808-670	\$512.95
Harmony	Markerboard	White	Specify	33-1/2"W x 25-1/2"D in	6-5008676-670	\$512.95	6-5008704-670	\$546.95	6-5008812-670	\$546.95
Affinity	Laminate	Specify	Specify	34-1/4"W x 23-1/2"D in	6-5008682-670	\$479.95	6-5008698-670	\$512.95	6-5008824-670	\$512.95
Affinity	Markerboard	White	Specify	34-1/4"W x 23-1/2"D in	6-5008723-670	\$512.95	6-5008693-670	\$546.95	6-5008827-670	\$546.95
Bond	Laminate	Specify	Specify	28W x 24D in	6-5008700-670	\$479.95	6-5008701-670	\$512.95	6-5008816-670	\$512.95
Bond	Markerboard	White	Specify	28W x 24D in	6-5008730-670	\$512.95	6-5008724-670	\$546.95	6-5008820-670	\$546.95
Gem Alliance	Laminate	Specify	Specify	33W x 23-3/4D in	6-5008665-670	\$479.95	6-5008712-670	\$512.95	6-5008832-670	\$512.95
Gem Alliance	Markerboard	White	Specify	33W x 23-3/4D in	6-5008670-670	\$512.95	6-5008725-670	\$646.95	6-5008837-670	\$546.95
<b>LockEdge® with Fidget Pedal</b>										
Harmony	Laminate	Specify	Specify	33-1/2"W x 25-1/2"D in	6-5008671-670	\$612.95	6-5008699-670	\$646.95	6-5008807-670	\$646.95
Harmony	Markerboard	White	Specify	33-1/2"W x 25-1/2"D in	6-5008692-670	\$646.95	6-5008716-670	\$679.95	6-5008811-670	\$679.95
Affinity	Laminate	Specify	Specify	34-1/4"W x 23-1/2"D in	6-5008680-670	\$612.95	6-5008722-670	\$646.95	6-5008823-670	\$646.95
Affinity	Markerboard	White	Specify	34-1/4"W x 23-1/2"D in	6-5008686-670	\$646.95	6-5008720-670	\$679.95	6-5008829-670	\$679.95
Bond	Laminate	Specify	Specify	28W x 24D in	6-5008721-670	\$612.95	6-5008711-670	\$646.95	6-5008815-670	\$646.95
Bond	Markerboard	White	Specify	28W x 24D in	6-5008710-670	\$646.95	6-5008705-670	\$679.95	6-5008819-670	\$679.95
Gem Alliance	Laminate	Specify	Specify	33W x 23-3/4D in	6-5008685-670	\$612.95	6-5008718-670	\$646.95	6-5008831-670	\$646.95
Gem Alliance	Markerboard	White	Specify	33W x 23-3/4D in	6-5008672-670	\$646.95	6-5008689-670	\$679.95	6-5008836-670	\$679.95

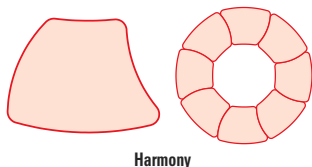

Harmony

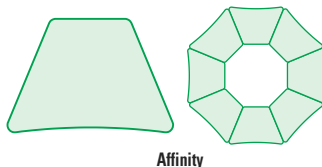

Affinity

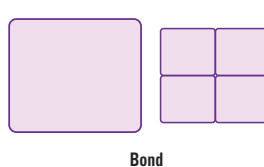

Bond

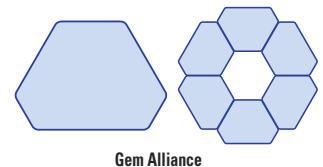

Gem Alliance





Refer to pages 60-61 for color options.



PRODUCT CERTIFIED FOR LOW CHEMICAL EMISSIONS: UL.COM/IGG UL 2818



Shown with optional Patented Fidget Pedal



Shown with optional Patented Fidget Pedal

### Classroom Select® Height Adjustable Sit/Stand Desk

The Classroom Select® Height Adjustable Sit/Stand Desk is an easy to move adjustable height desk that is perfect for the 21st century learning environment. The Tilt-N-Nest® model includes a simple lever release that allows the top to be folded down, with the desk then nestable for easy storage. The collaborative design with two casters, four stabilizing glides, and desktops that group together allow students to work together in pods in any classroom set-up. The height adjusts with an easy-squeeze lever that is located just under the desktop edge. Desktop height ranges from 27" to 44-1/4". Tabletop is made of 1-1/8" particleboard core with high pressure laminate top and T-Mold edge or LockEdge®. Available to order with a unique adjustable fidget pedal which promotes natural movement and enhances student focus which can be used sitting or standing. Desks with fidget pedal do not nest. Height Adjustable Sit/Stand Desks without the Tilt-N-Nest® feature are offered with a book box for added storage.

Top Shape	Top Type	Top Color	Edge Color	Product Dimensions	Without Tilt-N-Nest®		With Tilt-N-Nest®		Without Tilt-N-Nest®, With Book Box	
					Item #	List Price	Item #	List Price	Item #	List Price
<b>T-Mold Edge</b>										
Harmony	Laminate	Specify	Specify	33-1/2 W x 25-1/2 D in	6-5000942-670	\$512.95	6-5003112-670	\$546.95	6-5008845-670	\$546.95
Harmony	Markerboard	White	Specify	33-1/2 W x 25-1/2 D in	6-5000944-670	\$546.95	6-5003095-670	\$579.95	6-5008843-670	\$579.95
Affinity	Laminate	Specify	Specify	34-1/4 W x 23-1/2 D in	6-5000946-670	\$512.95	6-5003099-670	\$546.95	6-5008869-670	\$546.95
Affinity	Markerboard	White	Specify	34-1/4 W x 23-1/2 D in	6-5000948-670	\$546.95	6-5003120-670	\$579.95	6-5008867-670	\$579.95
Bond	Laminate	Specify	Specify	28 W x 24 D in	6-5000951-670	\$512.95	6-5003093-670	\$546.95	6-5008861-670	\$546.95
Bond	Markerboard	White	Specify	28 W x 24 D in	6-5000953-670	\$546.95	6-5003101-670	\$579.95	6-5008859-670	\$579.95
Gem Alliance	Laminate	Specify	Specify	33 W x 23-3/4 D in	6-5000955-670	\$512.95	6-5003108-670	\$546.95	6-5008851-670	\$546.95
Gem Alliance	Markerboard	White	Specify	33 W x 23-3/4 D in	6-5000957-670	\$546.95	6-5003100-670	\$579.95	6-5008853-670	\$579.95
<b>T-Mold Edge with Fidget Pedal</b>										
Harmony	Laminate	Specify	Specify	33-1/2 W x 25-1/2 D in	6-5000959-670	\$646.95	6-5003119-670	\$679.95	6-5008839-670	\$679.95
Harmony	Markerboard	White	Specify	33-1/2 W x 25-1/2 D in	6-5000961-670	\$679.95	6-5003123-670	\$712.95	6-5008840-670	\$712.95
Affinity	Laminate	Specify	Specify	34-1/4 W x 23-1/2 D in	6-5000963-670	\$646.95	6-5003102-670	\$679.95	6-5008865-670	\$679.95
Affinity	Markerboard	White	Specify	34-1/4 W x 23-1/2 D in	6-5000965-670	\$679.95	6-5003094-670	\$712.95	6-5008863-670	\$712.95
Bond	Laminate	Specify	Specify	28 W x 24 D in	6-5000967-670	\$646.95	6-5003111-670	\$679.95	6-5008857-670	\$679.95
Bond	Markerboard	White	Specify	28 W x 24 D in	6-5000969-670	\$679.95	6-5003098-670	\$712.95	6-5008855-670	\$712.95
Gem Alliance	Laminate	Specify	Specify	33 W x 23-3/4 D in	6-5000971-670	\$646.95	6-5003115-670	\$679.95	6-5008848-670	\$679.95
Gem Alliance	Markerboard	White	Specify	33 W x 23-3/4 D in	6-5000973-670	\$679.95	6-5003107-670	\$712.95	6-5008850-670	\$712.95
<b>LockEdge®</b>										
Harmony	Laminate	Specify	Specify	33-1/2 W x 25-1/2 D in	6-5000943-670	\$546.95	6-5003113-670	\$579.95	6-5008846-670	\$579.95
Harmony	Markerboard	White	Specify	33-1/2 W x 25-1/2 D in	6-5004807-670	\$579.95	6-5004815-670	\$612.95	6-5008844-670	\$612.95
Affinity	Laminate	Specify	Specify	34-1/4 W x 23-1/2 D in	6-5000947-670	\$546.95	6-5003124-670	\$579.95	6-5008870-670	\$579.95
Affinity	Markerboard	White	Specify	34-1/4 W x 23-1/2 D in	6-5004808-670	\$579.95	6-5004816-670	\$612.95	6-5008868-670	\$612.95
Bond	Laminate	Specify	Specify	28 W x 24 D in	6-5000952-670	\$546.95	6-5003122-670	\$579.95	6-5008862-670	\$579.95
Bond	Markerboard	White	Specify	28 W x 24 D in	6-5004809-670	\$579.95	6-5004817-670	\$612.95	6-5008860-670	\$612.95
Gem Alliance	Laminate	Specify	Specify	33 W x 23-3/4 D in	6-5000956-670	\$546.95	6-5003121-670	\$579.95	6-5008852-670	\$579.95
Gem Alliance	Markerboard	White	Specify	33 W x 23-3/4 D in	6-5004810-670	\$579.95	6-5004818-670	\$612.95	6-5008854-670	\$612.95
<b>LockEdge® with Fidget Pedal</b>										
Harmony	Laminate	Specify	Specify	33-1/2 W x 25-1/2 D in	6-5000960-670	\$679.95	6-5003097-670	\$712.95	6-5008842-670	\$712.95
Harmony	Markerboard	White	Specify	33-1/2 W x 25-1/2 D in	6-5004811-670	\$712.95	6-5004819-670	\$746.95	6-5008841-670	\$746.95
Affinity	Laminate	Specify	Specify	34-1/4 W x 23-1/2 D in	6-5000964-670	\$679.95	6-5003105-670	\$712.95	6-5008866-670	\$712.95
Affinity	Markerboard	White	Specify	34-1/4 W x 23-1/2 D in	6-5004812-670	\$712.95	6-5004820-670	\$746.95	6-5008864-670	\$746.95
Bond	Laminate	Specify	Specify	28 W x 24 D in	6-5000968-670	\$679.95	6-5003106-670	\$712.95	6-5008858-670	\$712.95
Bond	Markerboard	White	Specify	28 W x 24 D in	6-5004813-670	\$712.95	6-5004821-670	\$746.95	6-5008856-670	\$746.95
Gem Alliance	Laminate	Specify	Specify	33 W x 23-3/4 D in	6-5000972-670	\$679.95	6-5003114-670	\$712.95	6-5008849-670	\$712.95
Gem Alliance	Markerboard	White	Specify	33 W x 23-3/4 D in	6-5004814-670	\$712.95	6-5004822-670	\$746.95	6-5008847-670	\$746.95

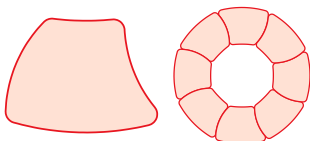

Harmony

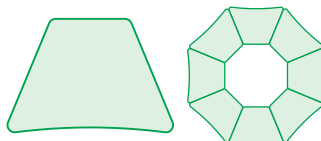

Affinity

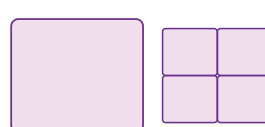

Bond

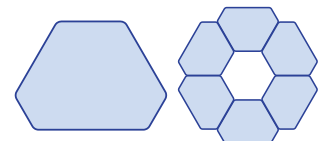

Gem Alliance



PRODUCT CERTIFIED FOR LOW CHEMICAL EMISSIONS: UL.COM/IGG UL 2818



Refer to pages 60-61 for color options.



Laminate with T-Mold



Laminate with LockEdge

**Classroom Select® Selective Tilt Podium**

The Classroom Select® Selective Tilt Podium is perfect for classroom use, for teachers and students alike. The easy height adjustment lever raises the podium from 29 to 44-1/2". Easily flip the podium top down with the tilt mechanism, to the user's preference. A built-in paper stop will insure your presentation notes stay in place. The table top tilts down into place and can be easily nested with other tables for safe compact storage. Durable heavy-duty steel column and base with 60mm locking casters allow smooth transitions. 26" W x 20" D top size in your choice of 32 laminate colors including markerboard top, in LockEdge® or T-Mold edge band. Base available in black powdercoat.

Item #	Description	Product Dimensions	Top Color	Edge Color	List Price
6-5009570-670	T-Mold Lectern	20 W x 26 D x 29 - 44-1/2H in	Specify	Specify	\$548.95
6-5009572-670	LockEdge Lectern	20 W x 26 D x 29 - 44-1/2H in	Specify	Specify	\$619.95
6-5009571-670	Markerboard T-Mold Lectern	20 W x 26 D x 29 - 44-1/2H in	Specify	Specify	\$565.95
6-5009573-670	Markerboard LockEdge Lectern	20 W x 26 D x 29 - 44-1/2H in	Specify	Specify	\$646.95



**Classroom Select® Drafting Tables**

The Classroom Select® Drafting Table has solid 2-1/4" maple legs and aprons with fully adjustable 3/4" almond colored plastic laminate top with the soft close feature. The top adjusts from 0 to 30 degrees. This one-piece top measure 36"W x 24"D. This unit is finished with an earth-friendly UV finish. Unit comes in either a 30" height or 36" height.

Item #	Description	Product Dimensions	List Price
6-674514-670	One Piece Top	36 W x 24 D x 30 H in	\$1,276.95
6-1399903-670	One Piece Top	36 W x 24 D x 36 H in	\$1,462.95



Refer to pages 60-61 for color options.

### Classroom Select® Royal Seating® 1600 Study Top Desk

Wide opening offers more leg room and accommodates oversized chairs. Frame is 1-1/8", 18-gauge steel, welded to 3/4", 18-gauge steel braces and connects directly to an 24" x 18", 26" x 20" A+, or 36" x 20" ADA compliant desktop for optimum support. Available with an optional wire book rack constructed of 4-gauge wire finished in rust resistant black finish. Tops available in either hard plastic or high pressure laminate; laminate tops come with your choice of colored LockEdge®, T-Mold edge, or painted edge in beige or titanium. Black frame, chrome-plated 1" 18-gauge tubular steel leg inserts adjust in 1" intervals from 22-1/2" to 31-1/2", 22-1/2" to 33-1/2" for the larger A+ size, and 28" to 34" for the ADA compliant sizes. On desks without a book rack, add the optional Classroom Select® Technology Basket as a simple storage solution for up to 14" laptops or tablets. Nylon leveling glides reduce noise. **Please order in carton quantities of 2. Quickship available without book rack in your choice of the following top color options: Gray Nebula, Fusion Maple, Bannister Oak or Nepal Teak for laminate with T-Mold. Light Gray, Beach (Beige) or Sugar Maple for Hard Plastic.**



Desk without Wire Book Rack



Desk with Wire Book Rack

Top Type	Edge Type	Top Size	Top Color	Edge Color	Without Book Rack		With Black Wire Book Rack	
					Item #	List Price	Item #	List Price
Laminate	24 W x 18 D in	Painted	Specify	Specify	<b>NEW</b> 6-5009954-670	\$146.95	<b>NEW</b> 6-5009956-670	\$179.95
Laminate	24 W x 18 D in	T-Mold	Specify	Specify	6-1458259-670	\$146.95	6-1364954-670	\$179.95
Hard Plastic	24 W x 18 D in	-	Specify	-	6-1459768-670	\$186.95	6-1459767-670	\$206.95
Laminate	24 W x 18 D in	LockEdge	Specify	Specify	6-1496602-670	\$192.95	6-1496606-670	\$212.95
Laminate	26 W x 20 D in A+	Painted	Specify	Specify	<b>NEW</b> 6-5009949-670	\$159.95	<b>NEW</b> 6-5009952-670	\$192.95
Laminate	26 W x 20 D in A+	T-Mold	Specify	Specify	6-1496603-670	\$159.95	6-1496607-670	\$192.95
Hard Plastic	26 W x 20 D in A+	-	Specify	-	6-1496604-670	\$199.95	6-1496608-670	\$219.95
Laminate	26 W x 20 D in A+	LockEdge	Specify	Specify	6-1496605-670	\$206.95	6-1496609-670	\$226.95
Laminate	36 W x 20 D in ADA	Painted	Specify	Specify	<b>NEW</b> 6-5009948-670	\$172.95	<b>NEW</b> 6-5009951-670	\$206.95
Laminate	36 W x 20 D in ADA	T-Mold	Specify	Specify	6-5002498-670	\$172.95	6-5002514-670	\$206.95
Hard Plastic	36 W x 20 D in ADA	-	Specify	-	6-5002676-670	\$212.95	6-5002672-670	\$232.95
Laminate	36 W x 20 D in ADA	LockEdge	Specify	Specify	6-5002494-670	\$219.95	6-5002525-670	\$239.95

Item #	Description	List Price
9-5002704-670	Technology Basket	\$31.95



The desk features a unique fidget pedal.



### Classroom Select® Royal 1600 Switch® Sit or Stand Desk with Fidget Pedal

This is a height-adjustable desk that provides endless benefits to any classroom setting. The top size is 26" x 20" with your choice of material. The height adjusts from 26" to 42" allowing the desk to be used for sitting or standing. Our patented fidget pedal promotes natural movement and enhances student focus. The heavy-duty receiving frame comes in a black finish with a chrome adjustable steel leg base frame for stability. All laminate tops feature your choice of T-Mold edge or LockEdge® colors. Choose from a black metal book box or black wire book rack.

Top Type	Edge Type	Top Color	Edge Color	Without Book Box		With Book Box		
				Item #	List Price	Item #	Book Box Type	List Price
Laminate	Painted	Specify	Specify	<b>NEW</b> 6-5009947-670	\$426.95	<b>NEW</b> 6-5009940-670	Specify	\$446.95
Laminate	T-Mold	Specify	Specify	6-5000008-670	\$426.95	6-1597915-670	Specify	\$446.95
Hard Plastic	-	Specify	-	6-5000010-670	\$452.95	6-1597916-670	Specify	\$472.95
Laminate	LockEdge	Specify	Specify	6-5000009-670	\$459.95	6-1598666-670	Specify	\$479.95
Markerboard	Painted	White	Specify	<b>NEW</b> 6-5009955-670	\$459.95	<b>NEW</b> 6-5009945-670	Specify	\$479.95
Markerboard	T-Mold	White	Specify	<b>NEW</b> 6-5009595-670	\$472.95	<b>NEW</b> 6-5009592-670	Specify	\$492.95
Markerboard	LockEdge	White	Specify	<b>NEW</b> 6-5009597-670	\$472.95	<b>NEW</b> 6-5009594-670	Specify	\$492.95





PRODUCT CERTIFIED FOR LOW CHEMICAL EMISSIONS: UL.COM/CGG UL 2818



**PLEASE SPECIFY COLOR CHOICE**

Refer to pages 60-61 for color options.

**Classroom Select® Royal Seating® 1600 Pedestal Leg Desk**

With the pedestal leg design, the Classroom Select® Royal Seating® Open Front Desk offers a sturdy, dependable workstation, featuring a wider opening that allows more leg room for oversized chairs. Desktops available in either hard plastic or high pressure laminate; laminate tops come with your choice of colored LockEdge®, T-Mold edge, or painted edge in beige or titanium. All tops come in your choice of 24" x 18" or 26" x 20" sizes. The legs are height adjustable from 23-1/2" to 33-1/2" and include an optional one-piece metal book box 20-1/2" W x 15" D x 4-1/2" H. On desks without a book box, add the optional Classroom Select® Technology Basket as a simple storage solution for up to 14" laptops or tablets.

**Please order desks in quantities of 2.**



Desk without Book Box

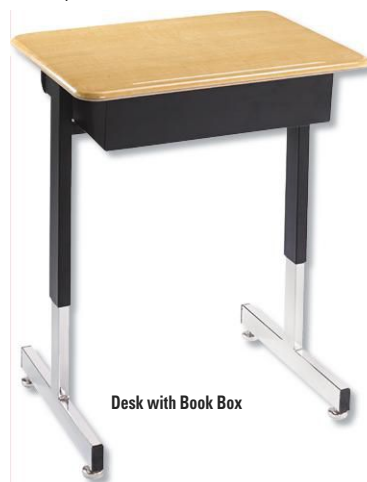

Desk with Book Box



Optional Technology Basket

Top Type	Top Size	Edge Type	Top Color	Edge Color	Metal Book Box		Without Book Box	
					Item #	List Price	Item #	List Price
Laminate	24 W x 18 D in	Painted	Specify	Specify	6-5009943-670	\$172.95	6-5009953-670	\$159.95
Laminate	24 W x 18 D in	T-Mold	Specify	Specify	6-1390748-670	\$172.95	6-1553171-670	\$159.95
Hard Plastic	24 W x 18 D in	-	Specify	-	6-1390747-670	\$199.95	6-1553172-670	\$186.95
Laminate	24 W x 18 D in	LockEdge	Specify	Specify	6-1497104-670	\$206.95	6-1553173-670	\$192.95
Laminate	26 W x 20 D in	Painted	Specify	Specify	6-5009941-670	\$186.95	6-5009950-670	\$172.95
Laminate	26 W x 20 D in	T-Mold	Specify	Specify	6-1497105-670	\$186.95	6-1553174-670	\$172.95
Hard Plastic	26 W x 20 D in	-	Specify	-	6-1497106-670	\$212.95	6-1553175-670	\$199.95
Laminate	26 W x 20 D in	LockEdge	Specify	Specify	6-1497107-670	\$219.95	6-1553176-670	\$206.95

Item #	Description	List Price
9-5002704-670	Technology Basket	\$31.95

**Classroom Select® Standing Height Advocate Series® Desk**

Facilitate an active learning environment with the Classroom Select® Standing Height Advocate Series® Desk. The durable 15-gauge steel pedestal legs attached to a 10-gauge steel mounting plate provide a sturdy 20" x 26" rectangle work surface for maximum student engagement. Legs adjust from 33"-42" standing height range, on 1" increments. Vinyl T-Mold edge is available on 1-1/8" particleboard. Colored LockEdge® is a sprayed on polyurethane edge on a 1-1/8" MDF top, providing increased durability. Available with a titanium metal book box or chrome wire book rack, or the sliding tote rails that will fit the Geode Series® Storage tote trays, sold separately. Purchase the Classroom Select® black or titanium Technology Basket for a simple storage solution for up to 14" laptops or tablets.



Product Dimensions	Top Type	Edge Type	Edge Color	Frame Color	Book Box Type	Laminate / Hard Plastic Top			Markerboard Top	
						Item #	Top Color	List Price	Item #	List Price
<b>Standing Height Desk</b>										
26 W x 20 D in	Hard Plastic	-	-	Titanium	-	6-5003760-670	Specify	\$332.95	-	-
26 W x 20 D in	Laminate	T-mold	Specify	Titanium	-	6-5003763-670	Specify	\$346.95	6-5003757-670	\$379.95
26 W x 20 D in	Laminate	LockEdge	Specify	Titanium	-	6-5003770-670	Specify	\$379.95	6-5004847-670	\$412.95
<b>Standing Height Desk with Tote Rails</b>										
26 W x 20 D in	Hard Plastic	-	-	Titanium	-	6-5003761-670	Specify	\$466.95	-	-
26 W x 20 D in	Laminate	T-mold	Specify	Titanium	-	6-5003771-670	Specify	\$479.95	6-5003758-670	\$512.95
26 W x 20 D in	Laminate	LockEdge	Specify	Titanium	-	6-5003767-670	Specify	\$512.95	6-5004848-670	\$546.95
<b>Standing Height Desk with Book Box</b>										
26 W x 20 D in	Hard Plastic	-	-	Titanium	Specify	6-5003759-670	Specify	\$399.95	-	-
26 W x 20 D in	Laminate	T-mold	Specify	Titanium	Specify	6-5003765-670	Specify	\$412.95	6-5003766-670	\$446.95
26 W x 20 D in	Laminate	LockEdge	Specify	Titanium	Specify	6-5003768-670	Specify	\$446.95	6-5003762-670	\$479.95

Item #	Description	List Price
9-2027667-670	3 in Tote Tray	\$17.95
9-5002704-670	Technology Basket	\$31.95

See page 253-256 for compatible Geode Series® Storage options

**CLASSROOM  
SELECT**



PRODUCT CERTIFIED  
FOR LOW CHEMICAL  
EMISSIONS:  
UL COMGG  
UL 2818



PLEASE  
SPECIFY  
COLOR  
CHOICE

Refer to pages 60-61  
for color options.



**Classroom Select® Contemporary Stand Up Collaboration Desk**

This Classroom Select® Contemporary Stand Up Collaboration student desk creates an ideal learning environment for student collaboration and classroom flexibility. All four available shapes are offered in either hard plastic or high pressure laminate; laminate tops come with your choice of colored LockEdge®, T-Mold edge, or painted edge. All items are offered with 30" to 43" adjustable height. Optional chrome wire book rack or black metal book box. **Quickship available, without book rack or book box, in the following top color options: Gray Nebula, Fusion Maple, Bannister Oak or Nepal Teak for laminate. Light Gray, Beach (Beige) or Sugar Maple for Hard Plastic.**

Top Shape	Top Type	Edge Type	Top Dimensions	Top Color	Edge Color	Without Book Box		With Book Box		
						Item #	List Price	Item #	Book Box Type	List Price
<b>Adjustable Height 30-43" without Casters</b>										
Rectangle	Laminate	Painted	26 W x 20 D in	Specify	Specify	6-1555002-670	\$259.95	6-1576499-670	Specify	\$292.95
Rectangle	<b>NEW</b> Laminate	T-Mold	26 W x 20 D in	Specify	Specify	6-5009391-670	\$259.95	6-5009344-670	Specify	\$292.95
Rectangle	Hard Plastic	—	26 W x 20 D in	Specify	—	6-1555003-670	\$286.95	6-1576500-670	Specify	\$319.95
Rectangle	Laminate	LockEdge	26 W x 20 D in	Specify	Specify	6-1555004-670	\$292.95	6-1576501-670	Specify	\$326.95
Triangle	Laminate	Painted	36 W x 24 D in	Specify	Specify	6-1495637-670	\$272.95	6-1576490-670	Specify	\$306.95
Triangle	<b>NEW</b> Laminate	T-Mold	36 W x 24 D in	Specify	Specify	6-5009408-670	\$272.95	6-5009347-670	Specify	\$306.95
Triangle	Hard Plastic	—	36 W x 24 D in	Specify	—	6-1495638-670	\$299.95	6-1576491-670	Specify	\$332.95
Triangle	Laminate	LockEdge	36 W x 24 D in	Specify	Specify	6-1495639-670	\$306.95	6-1576492-670	Specify	\$339.95
Hexagon	Laminate	Painted	33 W x 21 D in	Specify	Specify	6-1495640-670	\$272.95	6-1576493-670	Specify	\$306.95
Hexagon	<b>NEW</b> Laminate	T-Mold	33 W x 21 D in	Specify	Specify	6-5009390-670	\$272.95	6-5009360-670	Specify	\$306.95
Hexagon	Hard Plastic	—	33 W x 21 D in	Specify	—	6-1495641-670	\$299.95	6-1576494-670	Specify	\$332.95
Hexagon	Laminate	LockEdge	33 W x 21 D in	Specify	Specify	6-1495642-670	\$306.95	6-1576495-670	Specify	\$339.95
Octagon	Laminate	Painted	30 W x 21 D in	Specify	Specify	6-1495643-670	\$272.95	6-1576496-670	Specify	\$306.95
Octagon	<b>NEW</b> Laminate	T-Mold	30 W x 21 D in	Specify	Specify	6-5009413-670	\$272.95	6-5009338-670	Specify	\$306.95
Octagon	Hard Plastic	—	30 W x 21 D in	Specify	—	6-1495644-670	\$299.95	6-1576497-670	Specify	\$332.95
Octagon	Laminate	LockEdge	30 W x 21 D in	Specify	Specify	6-1495645-670	\$306.95	6-1576498-670	Specify	\$339.95
<b>Adjustable Height 30-43" with 2 Casters</b>										
Rectangle	Laminate	Painted	26 W x 20 D in	Specify	Specify	6-5002709-670	\$292.95	6-5002712-670	Specify	\$326.95
Rectangle	<b>NEW</b> Laminate	T-Mold	26 W x 20 D in	Specify	Specify	6-5009394-670	\$292.95	6-5009363-670	Specify	\$326.95
Rectangle	Hard Plastic	—	26 W x 20 D in	Specify	—	6-5002688-670	\$319.95	6-5002682-670	Specify	\$352.95
Rectangle	Laminate	LockEdge	26 W x 20 D in	Specify	Specify	6-5002706-670	\$326.95	6-5002705-670	Specify	\$359.95
Triangle	Laminate	Painted	36 W x 24 D in	Specify	Specify	6-5002643-670	\$306.95	6-5002607-670	Specify	\$339.95
Triangle	<b>NEW</b> Laminate	T-Mold	36 W x 24 D in	Specify	Specify	6-5009395-670	\$306.95	6-5009339-670	Specify	\$339.95
Triangle	Hard Plastic	—	36 W x 24 D in	Specify	—	6-5002689-670	\$332.95	6-5002678-670	Specify	\$366.95
Triangle	Laminate	LockEdge	36 W x 24 D in	Specify	Specify	6-5002562-670	\$339.95	6-5002581-670	Specify	\$372.95
Hexagon	Laminate	Painted	33 W x 21 D in	Specify	Specify	6-5002640-670	\$306.95	6-5002657-670	Specify	\$339.95
Hexagon	<b>NEW</b> Laminate	T-Mold	33 W x 21 D in	Specify	Specify	6-5009393-670	\$306.95	6-5009345-670	Specify	\$339.95
Hexagon	Hard Plastic	—	33 W x 21 D in	Specify	—	6-5002674-670	\$332.95	6-5002694-670	Specify	\$366.95
Hexagon	Laminate	LockEdge	33 W x 21 D in	Specify	Specify	6-5002577-670	\$339.95	6-5002659-670	Specify	\$372.95
Octagon	Laminate	Painted	30 W x 21 D in	Specify	Specify	6-5002669-670	\$306.95	6-5002611-670	Specify	\$339.95
Octagon	<b>NEW</b> Laminate	T-Mold	30 W x 21 D in	Specify	Specify	6-5009416-670	\$306.95	6-5009341-670	Specify	\$339.95
Octagon	Hard Plastic	—	30 W x 21 D in	Specify	—	6-5002703-670	\$332.95	6-5002702-670	Specify	\$366.95
Octagon	Laminate	LockEdge	30 W x 21 D in	Specify	Specify	6-5002588-670	\$339.95	6-5002605-670	Specify	\$372.95

Item #	Description	List Price
<b>Triangle Book Rack and Book Box</b>		
9-1412310-670	Chrome Wire Book Rack	\$46.95
9-1412311-670	Black Metal Book Box	\$46.95
<b>Hexagon and Octagon Book Rack and Book Box</b>		
9-1485212-670	Chrome Wire Book Rack	\$46.95
9-1485213-670	Black Metal Book Box	\$46.95
<b>Rectangle Book Rack and Book Box</b>		
9-1581776-670	Chrome Wire Book Rack	\$66.95
9-1581775-670	Black Metal Book Box	\$66.95





# CLASSROOM SELECT® DESK COMPARISON CHART

Use this chart to compare our top-selling desks to find the right product for your needs.



ROYAL SEATING®  
P. 55



CONTEMPORARY  
P. 46-47



TRADITIONAL  
P. 41



NEOCLASS®  
P. 41



NEOSHAP®  
P. 42



NEOMOVE®  
P. 44



CONCORD  
P. 45



ADVOCATE SERIES®  
P. 48-49



FIXED & HEIGHT ADJUSTABLE SIT/STAND  
P. 52-53

	ROYAL SEATING® P. 55	CONTEMPORARY P. 46-47	TRADITIONAL P. 41	NEOCLASS® P. 41	NEOSHAP® P. 42	NEOMOVE® P. 44	CONCORD P. 45	ADVOCATE SERIES® P. 48-49	FIXED & HEIGHT ADJUSTABLE SIT/STAND P. 52-53
Number of Top Shape Options	1	4	1	1	14	1	4	1	4
Top Type	Laminate, Markerboard, Hard Plastic	Laminate, Markerboard, Hard Plastic	Laminate, Markerboard, Hard Plastic	Laminate, Markerboard, Hard Plastic	Laminate, Markerboard	Laminate, Markerboard, Hard Plastic	Laminate, Markerboard	Laminate, Markerboard, Hard Plastic	Laminate, Markerboard
Edge Type	Painted, T-Mold, LockEdge®	Painted, T-Mold, LockEdge®	Painted, T-Mold, LockEdge®	Painted, T-Mold, LockEdge®	T-Mold, LockEdge®	Painted, T-Mold, LockEdge®	T-Mold, LockEdge®	T-Mold, LockEdge®	T-Mold, LockEdge®
Number of Edge Color Options	2 Painted, 5 T-Mold, 5 LockEdge®	2 Painted, 5 T-Mold, 5 LockEdge®	2 Painted, 5 T-Mold, 5 LockEdge®	2 Painted, 5 T-Mold, 5 LockEdge®	23 T-Mold, 5 LockEdge®	2 Painted, 5 T-Mold, 5 LockEdge®	23 T-Mold, 5 LockEdge®	23 T-Mold, 5 LockEdge®	23 T-Mold, 5 LockEdge®
Desk Type	4 Leg Combo, Sled Combo, Study Top, Open Front	4 Leg Combo, Sled Combo, Study Top, Open Front	4 Leg Combo, Sled Combo, Study Top, Open Front	4 Leg Combo, Sled Combo, Study Top, Open Front	Study Top	Study Top, Open Front	Study Top, Open Front	Study Top, Open Front	Study Top, Open Front
Leg Type	4-Leg	Round Tube	Round Tube	Round Tube	Round Tube, Elliptical Tube	Elliptical Tube	Round Tube	Elliptical Tube	Square Tube
	Cantilever		Round Tube	Elliptical Tube					
	Pedestal	Pedestal Leg	Pedestal Leg				Pedestal Leg		
Leg Color	Black, Chrome	Black, Chrome	Titanium, Black, Chrome	Titanium, Black, Chrome	11 color options	Titanium	Titanium	Titanium	Black
Height Options	Fixed Height		30"	30"					30"
	Height Adjustable	17 ¾" - 31 ½"	22 - 33" 30 - 43"	22 - 30"	22 - 30"	22 - 30"	22 - 30"	22 - 30"	21 - 30" 24 - 34" 33 - 42"
Glides/Casters	Glides	Nylon	Nylon	Nylon	Nylon	Nylon	Nylon	Nylon	Nylon
	Casters		Casters sold as a standard option			Sold separately on certain shapes	Casters sold as a standard option	Casters sold separately	Casters sold separately



# SAFCO®

## SAFCO® AlphaBetter® 2.0

Encourage healthy movement and provide convenient storage with the AlphaBetter® 2.0 height-adjustable student desk that features a high-pressure laminate top – available in gray or dry-erase markerboard – and under-surface book box. A pendulum footrest allows students to redirect excess energy and continue to move, even as they sit – providing ergonomic support, increasing comfort, and promoting cardiovascular health. Desks adjust from 22-30" or 29-43" with optional book box right beneath the desktop. All 29-43" desks accommodate students in 5th grade and up at seated and standing heights.



Item #	Product Dimensions	Edge Color	Top Type	Top Size	Edge Type	Frame Color	Top Color	List Price
<b>Without Book Box</b>								
6-2104732-670	27 W x 20 D x 22-30 H in	Gray	Laminate	27 W x 20 D in	Rounded	Gray	Gray	\$982.95
6-2104733-670	27 W x 20 D x 22-43 H in	Gray	Markerboard	27 W x 20 D in	Rounded	Gray	Markerboard	\$1,066.95
6-2104730-670	27 W x 20 D x 29-43 H in	Gray	Laminate	27 W x 20 D in	Rounded	Gray	Gray	\$1,119.95
6-2104731-670	27 W x 20 D x 29-43 H in	Gray	Markerboard	27 W x 20 D in	Rounded	Gray	Markerboard	\$1,146.95
<b>With Book Box</b>								
6-2104716-670	27 W x 20 D x 22-30 H in	Gray	Laminate	27 W x 20 D in	Rounded	Gray	Gray	\$1,197.95
6-2104724-670	27 W x 20 D x 22-30 H in	Gray	Markerboard	27 W x 20 D in	Rounded	Gray	Markerboard	\$1,224.95
6-2104727-670	27 W x 20 D x 29-43 H in	Gray	Laminate	27 W x 20 D in	Rounded	Gray	Gray	\$1,277.95
6-2104729-670	27 W x 20 D x 29-43 H in	Gray	Markerboard	27 W x 20 D in	Rounded	Gray	Markerboard	\$1,304.95



## Ergotron LearnFit® Adjustable Standing Desk

Transform classrooms and workstations into active learning environments with on-demand height adjustable standing desks. With the simple squeeze of a hand lever, kids and adults can change the height of their desktops to their preferred level so they can work and collaborate in the way that is natural for them.

Item #	Product Dimensions	List Price
6-1562577-670	24 W x 22 D x 29-45 H in	\$946.95
6-1559013-670	24 W x 22 D x 34-50 H in	\$952.95

## Correll Adjustable Height Standing Workstation

Versatile adjustable height desks feature sturdy steel frames and 1-1/4 Inch thick high pressure laminate tops, built with commercial grade quality. Use these standing height desks in schools, offices, warehouses and hospitals. Large, easy to use knobs and tamper resistant set screws allow for fast and secure height adjustment. Standing desks adjust 34 to 42 Inches high without casters. Optional casters are available.

**⚠️WARNING: This product can expose you to chemicals including Lead and Formaldehyde, which are known to the State of California to cause cancer and/or birth defects or other reproductive harm. For more information go to [www.P65Warnings.ca.gov](http://www.P65Warnings.ca.gov).**



### Correll Colors

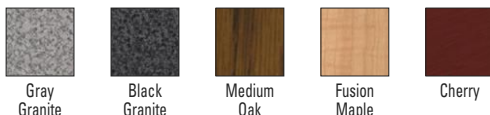

Item #	Product Dimensions	Laminate/Trim Color	List Price
6-1562479-670	24 W x 20 D in	Specify	\$539.95
6-1562480-670	36 W x 24 D in	Specify	\$597.95
6-1562481-670	48 W x 24 D in	Specify	\$606.95
6-1562482-670	60 W x 30 D in	Specify	\$710.95

Item #	Description	List Price
9-1562483-670	2 in Locking Casters	\$46.95



Color Name	Soft Plastic (Polypropylene) Seating								Hard Plastic Seating	Leg Uppers		Edges			Makerspace
	Chair Shells		Stools and Floor Seating				Desks	Royal Seating® 4100 Seat, Royal Seating® 4400 Combo Desk Seat & Art Stool		NeoClass® Elliptical Leg Uppers	Anolo® & Standard Leg Uppers	Painted Edge for Desk Tops Only	T-Mold Edge Band for 1 1/2" Tops Only	LocitEdge® 1/2" T-Mold Cafeteria LockEdge® & T-Mold	
	Inspiro® NeoClass®, NeoMove® & NeoMove2®	Contemporary, Traditional & Royal Seating®	NeoBok®, NeoSync® & Kurve®	NeoRyde® Stool	NeoRyde® Tablet Arm	ZoomStack® & NeoStat®									
Sunflower (Yellow)	●	●	●	●		●	●		●	●		●		●	
Saffron	●		●	●			●					●			
Tangerine	●		●	●	●	●	●		●			●		●	
Paprika	●		●	●			●					●			
Claret (Burgundy)	●	●	●	●			●	●				●			
Cardinal (Red)	●	●	●	●	●	●	●		●	●		●	●	●	
Lilac	●		●	●			●					●			
Violet	●		●	●	●	●	●		●			●		●	
Periwinkle	●		●	●			●					●			
Marine (Royal Blue)	●	●	●	●	●	●	●		●	●		●	●	●	
Indigo (Royal Blue)							●								
Sky	●		●	●	●	●	●		●			●		●	
Pacific	●		●	●			●					●			
Imperial (Navy Blue)	●	●	●	●	●	●	●					●		●	
Pistachio	●		●	●			●					●			
Lime	●		●	●	●	●	●		●			●		●	
Shamrock (Green)	●	●	●	●	●	●	●		●	●		●	●	●	
Forest (Hunter Green)	●	●	●	●			●					●			
Almond (Beige)	●	●	●	●			●		●	●	●	●			
Beach (Beige)							●								
Java	●		●	●			●					●			
Nickel	●		●	●			●					●			
Titanium									●	●	●	●	●		
Slate (Gray)	●	●	●	●	●	●	●					●		●	
Ebony (Black)	●	●	●	●	●	●	●	●	●	●		●	●	●	

CLASSROOM  
SELECT 

Laminates

(Activity Tabletop, Desktop, Cafeteria, Worksurface, and Side & Coffee Tabletop)

**Solid Laminate Colors**

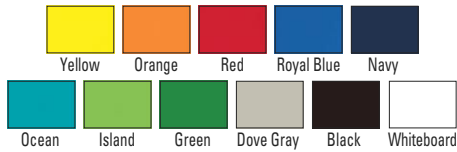

**Pattern Laminate Colors**



**Wood Grain Laminate Colors**



If surfaces are dirty, they can be cleaned using a detergent or soap and water prior to disinfection. For disinfection, most common EPA-registered household disinfectants should be effective. Follow manufacturer's instructions for all cleaning and disinfection products for concentration, application method and contact time, etc.. Additionally, diluted household bleach solutions (at least 1000ppm sodium hypochlorite) can be used if appropriate for the surface.

Above laminates available in a premium antimicrobial finish per special order request

Hard Plastics

Hard Plastic Desk Tops



Recommended Table/Desk and Chair Heights

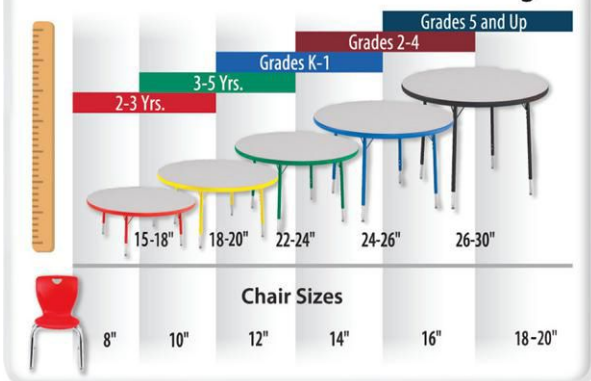

Soft Seating Fabrics

(NeoLink®, NeoFuse®, NeoLounge®, NeoDen®, Geode Series® Den, Community Table Bench and Storage Seat) (NeoLounge2® page 173 & 175)

Vinyl Fabrics - Grade 2 – 100% EPU Polyester, Backing Polyester, Bleach Cleanable



Coated Fabrics - Grade 2 – 100% EPU Polyester, Backing Polyester, Bleach Cleanable



Solid Fabrics - Grade 2 – 100% Post Consumer Recycled Polyester, Backing Latex, Clean with water based foam or cleaner



Patterned Fabrics - Grade 2 – 100% Polyester, Backing Acrylic, Clean with water-based foam or upholstery cleaner or dry cleaning solvents

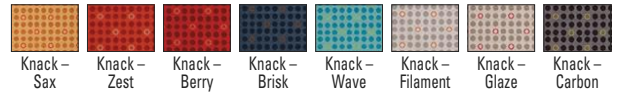

Chair Frame Paints

Chair Frame Paints

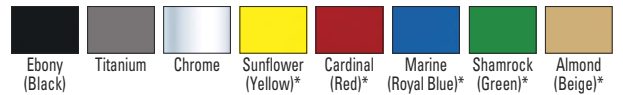

\*Option only available in Contemporary and Royal Matching Seat and Frame

Chair Pads

Chair Pad Fabrics



Glides



Glide Caps

Classroom Select® Glide Caps

Glide caps easily snap over the existing glides for an easy replacement option. Choose from nylon for tile and carpet flooring, steel for carpet and concrete, felt for tile and wood, and rubber for tile and wood.

Item #	Description	List Price
9-1432928-670	Nylon Glide Cap	\$1.15
9-1432929-670	Steel Glide Cap	\$1.15
9-1432930-670	Felt Glide Cap	\$1.15
9-1432931-670	Rubber Glide Cap	\$1.15



PRODUCT CERTIFIED FOR LOW CHEMICAL EMISSIONS: UL.COM/IGG UL 2818



Refer to pages 60-61 for color options.

**Classroom Select® Activity Tables with Power**

Our most popular classroom table, now offered with power, comes in a variety of shapes and sizes to suit any room. Available in a wide variety of high pressure laminate top options or markerboard top, and your choice of vinyl T-Mold edge banding or colored textured LockEdge® for added durability. T-Mold tables have a 1-1/8" particleboard core, LockEdge® Tables have a 1-1/8" MDF core. Tables 60" or longer have a 20-gauge galvanized steel stretcher bar permanently attached to the underside to prevent sagging. Tables are height adjustable on 1" centers. Available with an optional black metal book box, approximately 15" W x 11" D x 4-1/2" H, sold separately. Also add the Technology Basket as a simple storage solution for up to 14" laptops or tablets, sold separately. Various caster options available upon special request.

Top Shape	Product Dimensions	Product Height	Edge Color	Leg Color	Laminate Top			Markerboard Top	
					Item #	Top Color	List Price	Item #	List Price
<b>Standard Legs with T-Mold</b>									
Rectangle	60 W x 30 D in	Specify	Specify	Specify	6-5004175-670	Specify	\$546.95	6-5004173-670	\$586.95
Flower	60 in	Specify	Specify	Specify	6-5004167-670	Specify	\$652.95	6-5004166-670	\$692.95
Kidney	72 W x 48 D in	Specify	Specify	Specify	6-5004171-670	Specify	\$679.95	6-5004170-670	\$719.95
<b>Standard Legs with LockEdge</b>									
Rectangle	60 W x 30 D in	Specify	Specify	Specify	6-5004172-670	Specify	\$646.95	6-5004174-670	\$686.95
Flower	60 in	Specify	Specify	Specify	6-5004164-670	Specify	\$752.95	6-5004165-670	\$792.95
Kidney	72 W x 48 D in	Specify	Specify	Specify	6-5004168-670	Specify	\$779.95	6-5004169-670	\$819.95
<b>Apollo Legs with T-Mold</b>									
Rectangle	60 W x 30 D in	Specify	Specify	Specify	6-5004651-670	Specify	\$579.95	6-5004653-670	\$619.95
Flower	60 in	Specify	Specify	Specify	6-5004176-670	Specify	\$686.95	6-5004646-670	\$726.95
Kidney	72 W x 48 D in	Specify	Specify	Specify	6-5004650-670	Specify	\$712.95	6-5004649-670	\$752.95
<b>Apollo Legs with LockEdge</b>									
Rectangle	60 W x 30 D in	Specify	Specify	Specify	6-5004654-670	Specify	\$679.95	6-5004652-670	\$719.95
Flower	60 in	Specify	Specify	Specify	6-5004177-670	Specify	\$786.95	6-5004178-670	\$826.95
Kidney	72 W x 48 D in	Specify	Specify	Specify	6-5004647-670	Specify	\$812.95	6-5004648-670	\$852.95
<b>NeoClass Legs with T-Mold</b>									
Rectangle	60 W x 30 D in	Specify	Specify	Specify	6-5004663-670	Specify	\$599.95	6-5004662-670	\$639.95
Flower	60 in	Specify	Specify	Specify	6-5004657-670	Specify	\$706.95	6-5004656-670	\$746.95
Kidney	72 W x 48 D in	Specify	Specify	Specify	6-5004660-670	Specify	\$732.95	6-5004659-670	\$772.95
<b>NeoClass Legs with LockEdge</b>									
Rectangle	60 W x 30 D in	Specify	Specify	Specify	6-5004661-670	Specify	\$699.95	6-5004163-670	\$739.95
Flower	60 in	Specify	Specify	Specify	6-5004655-670	Specify	\$806.95	6-5004161-670	\$846.95
Kidney	72 W x 48 D in	Specify	Specify	Specify	6-5004658-670	Specify	\$832.95	6-5004162-670	\$872.95

Item #	Description	List Price
9-1547618-670	Activity Table Book Box	\$27.95
9-5002704-670	Technology Basket	\$31.95
9-2040212-670	Table Casters - Set of 4	\$30.95



Flower w/ Neoclass Legs



Kidney w/ Standard Legs



Rectangle w/ Apollo Legs



**Classroom Select® NeoLink® Laminate Colors**



Fusion Maple Amber Cherry Buka Bark

**To select your wall color, please refer to the colors listed under Soft Seating Fabrics on page 61.**

**Classroom Select® NeoLink® Media Wall with Table**

The Media Wall is an effective and smart solution for virtually any space. Designed for STEM classrooms, lounge areas and collaborative learning spaces, the table is 60" W x 38" D and the wall frame is 66" tall. The pedestal base consists of a 4" diameter 16-gauge steel tube column welded to a fixed mounting plate with a round base. Included with the Media Wall is a flat panel display mount for panels ranging in size from 42" to 61" and up to a 125 lbs. The mount is 36-3/8" W x 6" D x 21-5/16" H with a 10-degree tilt in either direction. Choose from our newly expanded fabric options for the wall. Available with and without power. The base is a platinum color. Choose from three laminate color options.

Item #	Description	Top Color	Fabric Color	List Price
6-5003901-670	Media Wall without Power	Specify	Specify	\$3,739.95
6-5003902-670	Media Wall with Power	Specify	Specify	\$3,975.95



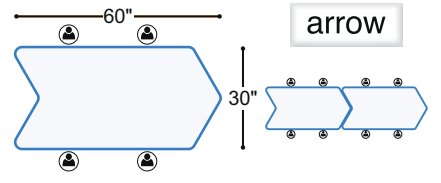

arrow

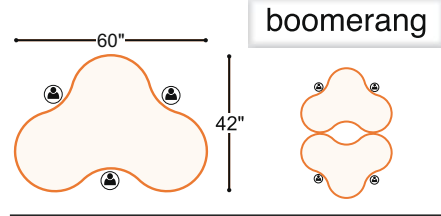

boomerang

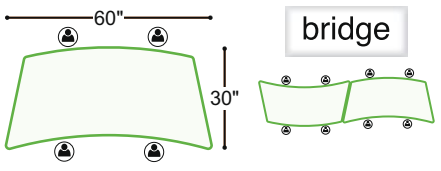

bridge

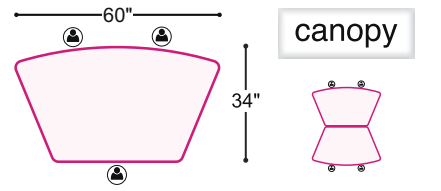

canopy

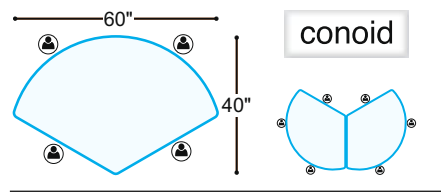

conoid

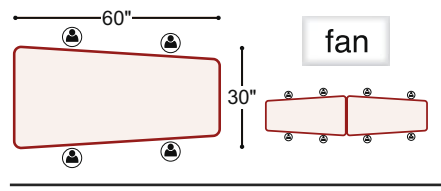

fan

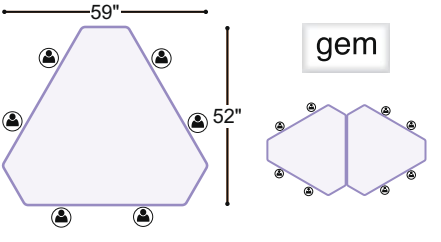

gem

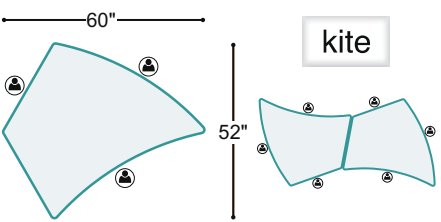

kite

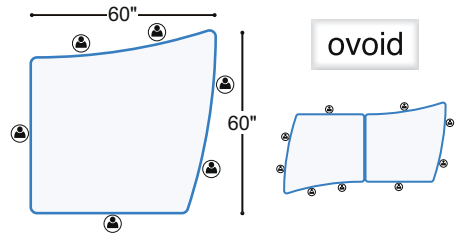

ovoid

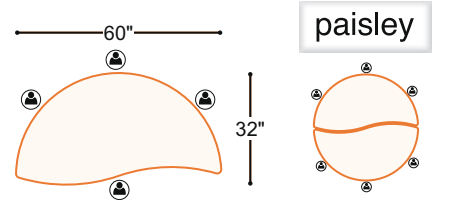

paisley

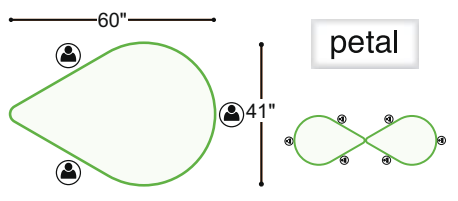

petal

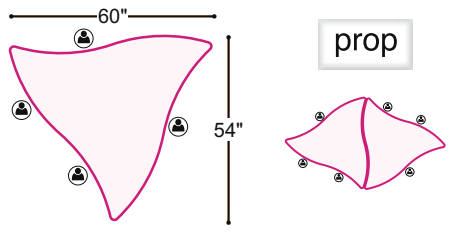

prop

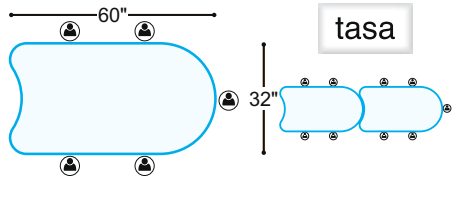

tasa

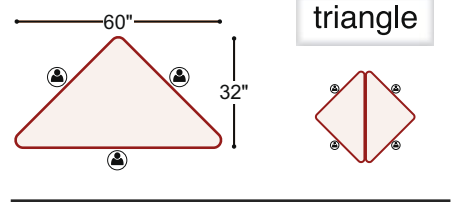

triangle

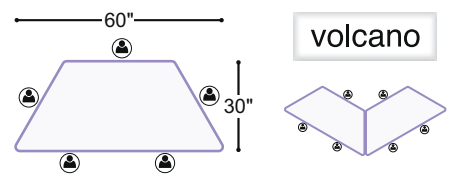

volcano

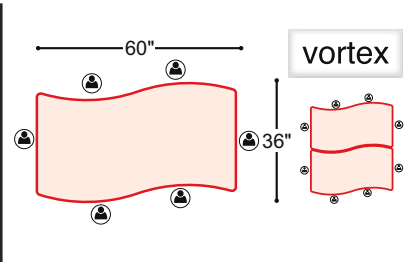

vortex

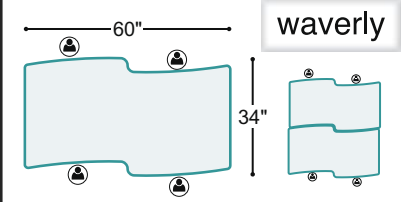

waverly

**Tables designed for stand-alone setup/use:**

centric

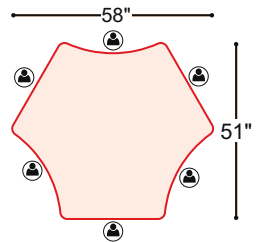

mesa

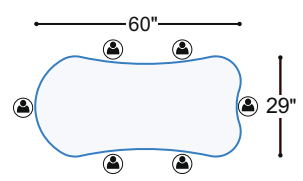

swirl

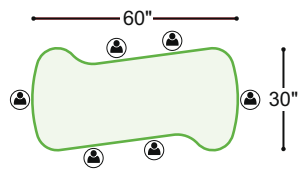

**CLASSROOM  
SELECT** 



PRODUCT CERTIFIED  
FOR LOW CHEMICAL  
EMISSIONS:  
UL.COM/CGG  
UL2818



PLEASE  
SPECIFY  
COLOR  
CHOICE

Refer to pages 60-61  
for color options.

See Page 63 for Table  
Shape Options



**Choose your  
Premium  
Elliptical Height  
Option**

- Adjusts from 15" to 25" or
- Adjusts from 22" to 30" or
- Adjusts from 30" to 43"\*

\*Available for all shapes  
except: Boomerang, Gem,  
Prop and Triangle

**Classroom Select® T-Mold NeoShape® Activity Table with NeoClass® Legs**

Activity table shapes are ideal for collaborative group activities and can be arranged in various configurations for shared connectivity. Tables with T-Mold edge are made of 1-1/8" particleboard core and are constructed with a galvanized steel stretcher bar attached underneath for extra stability. Premium elliptical leg adjusts from 15" to 25", 22" to 30" or 30" to 43" table surface height. Optional caster inserts are available for leg height 22" to 30", or the standing leg height 30" to 43".

Top Shape	Product Dimensions	Product Height	Edge Color	Leg Color	Laminate Top			Markerboard Top	
					Item #	Top Color	List Price	Item #	List Price
Arrow	60 W x 30 D in	Specify	Specify	Specify	6-1597966-670	Specify	\$439.95	6-1597967-670	\$486.95
Bridge	60 W x 30 D in	Specify	Specify	Specify	6-1597958-670	Specify	\$439.95	6-1597959-670	\$486.95
Fan	60 W x 30 D in	Specify	Specify	Specify	6-1597983-670	Specify	\$439.95	6-1597984-670	\$486.95
Mesa	60 W x 29 D in	Specify	Specify	Specify	6-1598052-670	Specify	\$439.95	6-1598053-670	\$486.95
Swirl	60 W x 30 D in	Specify	Specify	Specify	6-1598048-670	Specify	\$439.95	6-1598049-670	\$486.95
Volcano	60 W x 30 D in	Specify	Specify	Specify	6-1598011-670	Specify	\$439.95	6-1598012-670	\$486.95
Boomerang	60 W x 42 D in	Specify	Specify	Specify	6-1597991-670	Specify	\$466.95	6-1597992-670	\$512.95
Conoid	60 W x 40 D in	Specify	Specify	Specify	6-1598019-670	Specify	\$466.95	6-1598020-670	\$512.95
Kite	60 W x 52 D in	Specify	Specify	Specify	6-1598027-670	Specify	\$466.95	6-1598028-670	\$512.95
Paisley	60 W x 32 D in	Specify	Specify	Specify	6-1598036-670	Specify	\$466.95	6-1598037-670	\$512.95
Prop	60 W x 54 D in	Specify	Specify	Specify	6-1598032-670	Specify	\$466.95	6-1598033-670	\$512.95
Triangle	60 W x 32 D in	Specify	Specify	Specify	6-1597999-670	Specify	\$466.95	6-1598000-670	\$512.95
Canopy	60 W x 34 D in	Specify	Specify	Specify	6-1598007-670	Specify	\$492.95	6-1598008-670	\$539.95
Petal	60 W x 41 D in	Specify	Specify	Specify	6-1597975-670	Specify	\$492.95	6-1597976-670	\$539.95
Tasa	60 W x 32 D in	Specify	Specify	Specify	6-1598003-670	Specify	\$492.95	6-1598004-670	\$539.95
Waverly	60 W x 34 D in	Specify	Specify	Specify	6-1597962-670	Specify	\$492.95	6-1597963-670	\$539.95
Gem	59 W x 52 D in	Specify	Specify	Specify	6-1598023-670	Specify	\$519.95	6-1598024-670	\$566.95
Ovoid	60 W x 60 D in	Specify	Specify	Specify	6-1597995-670	Specify	\$519.95	6-1597996-670	\$566.95
Vortex	60 W x 36 D in	Specify	Specify	Specify	6-1598040-670	Specify	\$519.95	6-1598041-670	\$566.95
Centric	58 W x 51 D in	Specify	Specify	Specify	6-1598044-670	Specify	\$599.95	6-1598045-670	\$646.95

Item #	Description	List Price
<b>Elliptical Leg Caster Inserts (Sets of 2)</b>		
6-1609060-670	Caster Inserts for 22-30" Leg	\$59.95
6-5002713-670	Caster Inserts for 30-43" Leg	\$119.95

Item #	Description	Color	List Price
<b>Additional Power Options</b>			
6-5004132-670	Clamp Mount	Specify	\$366.95
6-5004726-670	Under Table Mount	Specify	\$366.95

Item #	Description	List Price
9-2106265-670	Rail Kit w/out Tote	\$79.95
9-2104262-670	Rail Kit with Clear Tote	\$92.95



**CLASSROOM  
SELECT** 



PRODUCT CERTIFIED  
FOR LOW CHEMICAL  
EMISSIONS:  
UL.COM/GG  
UL 2818



PLEASE  
SPECIFY  
**COLOR  
CHOICE**

Refer to pages 60-61  
for color options.



Clamp Mount



Under Table Mount

**Classroom Select® LockEdge® NeoShape® Activity Table with NeoClass® Legs**

Activity table shapes are ideal for collaborative group activities and can be arranged in various configurations for shared connectivity. Tabletops are constructed from a 1-1/8" MDF core with black, textured LockEdge® for superior durability and easy maintenance. Tables feature a galvanized steel stretcher bar attached underneath for extra stability. Premium elliptical leg adjusts from 15" to 25", 22" to 30" or 30" to 43" table surface height. Optional caster inserts are available for leg height 22" to 30", or the standing leg height 30" to 43".

Top Shape	Product Dimensions	Product Height	Edge Color	Leg Color	Laminate Top			Markerboard Top	
					Item #	Top Color	List Price	Item #	List Price
Arrow	60 W x 30 D in	Specify	Specify	Specify	6-1599204-670	Specify	\$539.95	6-1597968-670	\$586.95
Bridge	60 W x 30 D in	Specify	Specify	Specify	6-1597957-670	Specify	\$539.95	6-1597960-670	\$586.95
Fan	60 W x 30 D in	Specify	Specify	Specify	6-1597982-670	Specify	\$539.95	6-1597985-670	\$586.95
Mesa	60 W x 29 D in	Specify	Specify	Specify	6-1598051-670	Specify	\$539.95	6-1598054-670	\$586.95
Swirl	60 W x 30 D in	Specify	Specify	Specify	6-1598047-670	Specify	\$539.95	6-1598050-670	\$586.95
Volcano	60 W x 30 D in	Specify	Specify	Specify	6-1598010-670	Specify	\$539.95	6-1598013-670	\$586.95
Boomerang	60 W x 42 D in	Specify	Specify	Specify	6-1597990-670	Specify	\$566.95	6-1597993-670	\$612.95
Conoid	60 W x 40 D in	Specify	Specify	Specify	6-1598018-670	Specify	\$566.95	6-1598021-670	\$612.95
Kite	60 W x 52 D in	Specify	Specify	Specify	6-1598026-670	Specify	\$566.95	6-1598030-670	\$612.95
Paisley	60 W x 32 D in	Specify	Specify	Specify	6-1598035-670	Specify	\$566.95	6-1598038-670	\$612.95
Prop	60 W x 54 D in	Specify	Specify	Specify	6-1598031-670	Specify	\$566.95	6-1598034-670	\$612.95
Triangle	60 W x 32 D in	Specify	Specify	Specify	6-1597998-670	Specify	\$566.95	6-1598001-670	\$612.95
Canopy	60 W x 34 D in	Specify	Specify	Specify	6-1598006-670	Specify	\$592.95	6-1598009-670	\$639.95
Petal	60 W x 41 D in	Specify	Specify	Specify	6-1597974-670	Specify	\$592.95	6-1597977-670	\$639.95
Tasa	60 W x 32 D in	Specify	Specify	Specify	6-1598002-670	Specify	\$592.95	6-1598005-670	\$639.95
Waverly	60 W x 34 D in	Specify	Specify	Specify	6-1597961-670	Specify	\$592.95	6-1597964-670	\$639.95
Gem	59 W x 52 D in	Specify	Specify	Specify	6-1598022-670	Specify	\$619.95	6-1598025-670	\$666.95
Ovoid	60 W x 60 D in	Specify	Specify	Specify	6-1597994-670	Specify	\$619.95	6-1597997-670	\$666.95
Vortex	60 W x 36 D in	Specify	Specify	Specify	6-1598039-670	Specify	\$619.95	6-1598042-670	\$666.95
Centric	58 W x 51 D in	Specify	Specify	Specify	6-1598043-670	Specify	\$699.95	6-1598046-670	\$746.95

Item #	Description	List Price
<b>Elliptical Leg Caster Inserts (Sets of 2)</b>		
6-1609060-670	Caster Inserts for 22-30" Leg	\$59.95
6-5002713-670	Caster Inserts for 30-43" Leg	\$119.95

Item #	Description	Color	List Price
<b>Additional Power Options</b>			
6-5004132-670	Clamp Mount	Specify	\$366.95
6-5004726-670	Under Table Mount	Specify	\$366.95

Item #	Description	List Price
9-2106265-670	Rail Kit w/out Tote	\$79.95
9-2104262-670	Rail Kit with Clear Tote	\$92.95



**PLEASE SPECIFY COLOR CHOICE**  
Refer to pages 60-61 for color options.

**UL GREENGUARD GOLD**  
PRODUCT CERTIFIED FOR LOW CHEMICAL EMISSIONS: UL.COM/SGG UL-2818

**LIMITED LIFETIME WARRANTY**

**CLASSROOM SELECT**

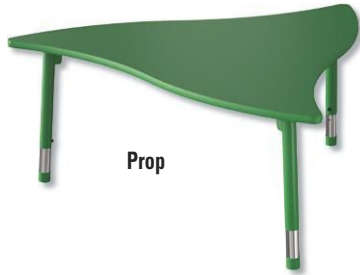

Prop



Arrow with Markerboard Top



Tasa

**Classroom Select® NeoShape® Activity Table with Apollo® Legs**

Activity table shapes are ideal for collaborative group activities and can be arranged in various configurations for shared connectivity. Tables with T-Mold edge are made of 1-1/8" particleboard core, and LockEdge® are made of 1-1/8" MDF core with high pressure laminate top, and phenolic resin backer. Constructed with a galvanized steel stretcher bar attached underneath for extra stability. The Apollo® leg is available in 11" to 17", 15" to 25" or 22" to 30" adjustable height ranges. Add a set of two caster inserts to make your table mobile.

Top Shape	Product Dimensions	Product Height	Edge Color	Leg Color	Laminate Top			Markerboard Top	
					Item #	Top Color	List Price	Item #	List Price
<b>T-Mold Edge</b>									
Arrow	60 W x 30 D in	Specify	Specify	Specify	6-1598064-670	Specify	\$406.95	6-1598065-670	\$452.95
Bridge	60 W x 30 D in	Specify	Specify	Specify	6-1598056-670	Specify	\$406.95	6-1598057-670	\$452.95
Fan	60 W x 30 D in	Specify	Specify	Specify	6-1598080-670	Specify	\$406.95	6-1598081-670	\$452.95
Mesa	60 W x 29 D in	Specify	Specify	Specify	6-1598148-670	Specify	\$406.95	6-1598149-670	\$452.95
Swirl	60 W x 30 D in	Specify	Specify	Specify	6-1598144-670	Specify	\$406.95	6-1598145-670	\$452.95
Volcano	60 W x 30 D in	Specify	Specify	Specify	6-1598108-670	Specify	\$406.95	6-1598109-670	\$452.95
Boomerang	60 W x 42 D in	Specify	Specify	Specify	6-1598088-670	Specify	\$432.95	6-1598089-670	\$479.95
Conoid	60 W x 40 D in	Specify	Specify	Specify	6-1598116-670	Specify	\$432.95	6-1598117-670	\$479.95
Kite	60 W x 52 D in	Specify	Specify	Specify	6-1598124-670	Specify	\$432.95	6-1598125-670	\$479.95
Paisley	60 W x 32 D in	Specify	Specify	Specify	6-1598132-670	Specify	\$432.95	6-1598133-670	\$479.95
Prop	60 W x 54 D in	Specify	Specify	Specify	6-1598128-670	Specify	\$432.95	6-1598129-670	\$479.95
Triangle	60 W x 32 D in	Specify	Specify	Specify	6-1598096-670	Specify	\$432.95	6-1598097-670	\$479.95
Canopy	60 W x 34 D in	Specify	Specify	Specify	6-1598104-670	Specify	\$459.95	6-1598105-670	\$506.95
Petal	60 W x 41 D in	Specify	Specify	Specify	6-1598072-670	Specify	\$459.95	6-1598073-670	\$506.95
Tasa	60 W x 32 D in	Specify	Specify	Specify	6-1598100-670	Specify	\$459.95	6-1598101-670	\$506.95
Waverly	60 W x 34 D in	Specify	Specify	Specify	6-1598060-670	Specify	\$459.95	6-1598061-670	\$506.95
Gem	59 W x 52 D in	Specify	Specify	Specify	6-1598120-670	Specify	\$486.95	6-1598121-670	\$532.95
Ovoid	60 W x 60 D in	Specify	Specify	Specify	6-1598092-670	Specify	\$486.95	6-1598093-670	\$532.95
Vortex	60 W x 36 D in	Specify	Specify	Specify	6-1598136-670	Specify	\$486.95	6-1598137-670	\$532.95
Centric	58 W x 51 D in	Specify	Specify	Specify	6-1598140-670	Specify	\$566.95	6-1598141-670	\$612.95
<b>LockEdge®</b>									
Arrow	60 W x 30 D in	Specify	Specify	Specify	6-1598063-670	Specify	\$506.95	6-1598066-670	\$552.95
Bridge	60 W x 30 D in	Specify	Specify	Specify	6-1598055-670	Specify	\$506.95	6-1598058-670	\$552.95
Fan	60 W x 30 D in	Specify	Specify	Specify	6-1598079-670	Specify	\$506.95	6-1598082-670	\$552.95
Mesa	60 W x 29 D in	Specify	Specify	Specify	6-1598147-670	Specify	\$506.95	6-1598150-670	\$552.95
Swirl	60 W x 30 D in	Specify	Specify	Specify	6-1598143-670	Specify	\$506.95	6-1598146-670	\$552.95
Volcano	60 W x 30 D in	Specify	Specify	Specify	6-1598107-670	Specify	\$506.95	6-1598110-670	\$552.95
Boomerang	60 W x 42 D in	Specify	Specify	Specify	6-1598087-670	Specify	\$532.95	6-1598090-670	\$579.95
Conoid	60 W x 40 D in	Specify	Specify	Specify	6-1598115-670	Specify	\$532.95	6-1598118-670	\$579.95
Kite	60 W x 52 D in	Specify	Specify	Specify	6-1598123-670	Specify	\$532.95	6-1598126-670	\$579.95
Paisley	60 W x 32 D in	Specify	Specify	Specify	6-1598131-670	Specify	\$532.95	6-1598134-670	\$579.95
Prop	60 W x 54 D in	Specify	Specify	Specify	6-1598127-670	Specify	\$532.95	6-1598130-670	\$579.95
Triangle	60 W x 32 D in	Specify	Specify	Specify	6-1598095-670	Specify	\$532.95	6-1598098-670	\$579.95
Canopy	60 W x 34 D in	Specify	Specify	Specify	6-1598103-670	Specify	\$559.95	6-1598106-670	\$606.95
Petal	60 W x 41 D in	Specify	Specify	Specify	6-1598071-670	Specify	\$559.95	6-1598074-670	\$606.95
Tasa	60 W x 32 D in	Specify	Specify	Specify	6-1598099-670	Specify	\$559.95	6-1598102-670	\$606.95
Waverly	60 W x 34 D in	Specify	Specify	Specify	6-1598059-670	Specify	\$559.95	6-1598062-670	\$606.95
Gem	59 W x 52 D in	Specify	Specify	Specify	6-1598119-670	Specify	\$586.95	6-1598122-670	\$632.95
Ovoid	60 W x 60 D in	Specify	Specify	Specify	6-1598091-670	Specify	\$586.95	6-1598094-670	\$632.95
Vortex	60 W x 36 D in	Specify	Specify	Specify	6-1598135-670	Specify	\$586.95	6-1598138-670	\$632.95
Centric	58 W x 51 D in	Specify	Specify	Specify	6-1598139-670	Specify	\$666.95	6-1598142-670	\$712.95

Item #	Description	List Price
<b>Apollo Leg Caster Inserts (Set of 2) for 22 to 30 inch Leg Height</b>		
6-1563290-670	Apollo Leg Caster Inserts (2)	\$59.95

Item #	Description	List Price
9-2106265-670	Rail Kit w/out Tote	\$79.95
9-2104262-670	Rail Kit with Clear Tote	\$92.95

**See Page 63 for Table Shapes and Configurations**





Refer to pages 60-61 for color options.



PRODUCT CERTIFIED FOR LOW CHEMICAL EMISSIONS: UL.COM/GG UL 2818



Centric



Petal with Markerboard Top



Kite

**Classroom Select® NeoShape® Activity Table with Standard Legs**

Activity table shapes are ideal for collaborative group activities and can be arranged in various configurations for shared connectivity. Tables with T-Mold edge are made of 1-1/8" particleboard core, and LockEdge® are made of 1-1/8" MDF core with high pressure laminate top, and phenolic resin backer. Constructed with a galvanized steel stretcher bar attached underneath for extra stability. The legs are available in 15" to 25" or 22" to 30" adjustable height ranges.

Top Shape	Product Dimensions	Product Height	Edge Color	Leg Color	Laminate Top		Markerboard Top		
					Item #	Top Color	List Price	Item #	List Price
<b>T-Mold Edge</b>									
Arrow	60 W x 30 D in	Specify	Specify	Specify	6-1598160-670	Specify	\$359.95	6-1598162-670	\$406.95
Bridge	60 W x 30 D in	Specify	Specify	Specify	6-1598152-670	Specify	\$359.95	6-1598154-670	\$406.95
Fan	60 W x 30 D in	Specify	Specify	Specify	6-1598177-670	Specify	\$359.95	6-1598179-670	\$406.95
Mesa	60 W x 29 D in	Specify	Specify	Specify	6-1598245-670	Specify	\$359.95	6-1598247-670	\$406.95
Swirl	60 W x 30 D in	Specify	Specify	Specify	6-1598241-670	Specify	\$359.95	6-1598243-670	\$406.95
Volcano	60 W x 30 D in	Specify	Specify	Specify	6-1598205-670	Specify	\$359.95	6-1598207-670	\$406.95
Boomerang	60 W x 42 D in	Specify	Specify	Specify	6-1598185-670	Specify	\$386.95	6-1598187-670	\$432.95
Conoid	60 W x 40 D in	Specify	Specify	Specify	6-1598213-670	Specify	\$386.95	6-1598215-670	\$432.95
Kite	60 W x 52 D in	Specify	Specify	Specify	6-1598221-670	Specify	\$386.95	6-1598223-670	\$432.95
Paisley	60 W x 32 D in	Specify	Specify	Specify	6-1598229-670	Specify	\$386.95	6-1598231-670	\$432.95
Prop	60 W x 54 D in	Specify	Specify	Specify	6-1598225-670	Specify	\$386.95	6-1598227-670	\$432.95
Triangle	60 W x 32 D in	Specify	Specify	Specify	6-1598193-670	Specify	\$386.95	6-1598195-670	\$432.95
Canopy	60 W x 34 D in	Specify	Specify	Specify	6-1598201-670	Specify	\$412.95	6-1598203-670	\$459.95
Petal	60 W x 41 D in	Specify	Specify	Specify	6-1598169-670	Specify	\$412.95	6-1598171-670	\$459.95
Tasa	60 W x 32 D in	Specify	Specify	Specify	6-1598197-670	Specify	\$412.95	6-1598199-670	\$459.95
Waverly	60 W x 34 D in	Specify	Specify	Specify	6-1598156-670	Specify	\$412.95	6-1598158-670	\$459.95
Gem	59 W x 52 D in	Specify	Specify	Specify	6-1598217-670	Specify	\$439.95	6-1598219-670	\$486.95
Ovoid	60 W x 60 D in	Specify	Specify	Specify	6-1598189-670	Specify	\$439.95	6-1598191-670	\$486.95
Vortex	60 W x 36 D in	Specify	Specify	Specify	6-1598233-670	Specify	\$439.95	6-1598235-670	\$486.95
Centric	58 W x 51 D in	Specify	Specify	Specify	6-1598237-670	Specify	\$519.95	6-1598239-670	\$566.95
<b>LockEdge®</b>									
Arrow	60 W x 30 D in	Specify	Specify	Specify	6-1598159-670	Specify	\$459.95	6-1598161-670	\$506.95
Bridge	60 W x 30 D in	Specify	Specify	Specify	6-1598151-670	Specify	\$459.95	6-1598153-670	\$506.95
Fan	60 W x 30 D in	Specify	Specify	Specify	6-1598176-670	Specify	\$459.95	6-1598178-670	\$506.95
Mesa	60 W x 29 D in	Specify	Specify	Specify	6-1598244-670	Specify	\$459.95	6-1598246-670	\$506.95
Swirl	60 W x 30 D in	Specify	Specify	Specify	6-1598240-670	Specify	\$459.95	6-1598242-670	\$506.95
Volcano	60 W x 30 D in	Specify	Specify	Specify	6-1598204-670	Specify	\$459.95	6-1598206-670	\$506.95
Boomerang	60 W x 42 D in	Specify	Specify	Specify	6-1598184-670	Specify	\$486.95	6-1598186-670	\$532.95
Conoid	60 W x 40 D in	Specify	Specify	Specify	6-1598212-670	Specify	\$486.95	6-1598214-670	\$532.95
Kite	60 W x 52 D in	Specify	Specify	Specify	6-1598220-670	Specify	\$486.95	6-1598222-670	\$532.95
Paisley	60 W x 32 D in	Specify	Specify	Specify	6-1598228-670	Specify	\$486.95	6-1598230-670	\$532.95
Prop	60 W x 54 D in	Specify	Specify	Specify	6-1598224-670	Specify	\$486.95	6-1598226-670	\$532.95
Triangle	60 W x 32 D in	Specify	Specify	Specify	6-1598192-670	Specify	\$486.95	6-1598194-670	\$532.95
Canopy	60 W x 34 D in	Specify	Specify	Specify	6-1598200-670	Specify	\$512.95	6-1598202-670	\$559.95
Petal	60 W x 41 D in	Specify	Specify	Specify	6-1598168-670	Specify	\$512.95	6-1598170-670	\$559.95
Tasa	60 W x 32 D in	Specify	Specify	Specify	6-1598196-670	Specify	\$512.95	6-1598198-670	\$559.95
Waverly	60 W x 34 D in	Specify	Specify	Specify	6-1598155-670	Specify	\$512.95	6-1598157-670	\$559.95
Gem	59 W x 52 D in	Specify	Specify	Specify	6-1598216-670	Specify	\$539.95	6-1598218-670	\$586.95
Ovoid	60 W x 60 D in	Specify	Specify	Specify	6-1598188-670	Specify	\$539.95	6-1598190-670	\$586.95
Vortex	60 W x 36 D in	Specify	Specify	Specify	6-1598232-670	Specify	\$539.95	6-1598234-670	\$586.95
Centric	58 W x 51 D in	Specify	Specify	Specify	6-1598236-670	Specify	\$619.95	6-1598238-670	\$666.95

**Choose your Standard Leg Height Option**

- Adjusts from 15" to 25" or
- Adjusts from 22" to 30"

**See Page 63 for Table Shapes and Configurations**

Item #	Description	List Price
9-2106265-670	Rail Kit w/out Tote	\$79.95
9-2104262-670	Rail Kit with Clear Tote	\$92.95

**CLASSROOM  
SELECT**



PRODUCT CERTIFIED FOR LOW CHEMICAL EMISSIONS: UL COMGG UL 2816



PLEASE SPECIFY COLOR CHOICE

Refer to pages 60-61 for color options.



**Classroom Select® T-Mold Activity Table with NeoClass® Legs**

These traditional shape tables are perfect for collaborative interaction, encouraging student creativity and learning. Tables with T-Mold edge are made of 1-1/8" particleboard core and are constructed with a galvanized steel stretcher bar attached underneath for extra stability. Premium elliptical leg adjusts the top height from 15" to 25", 22" to 30" or 30" to 43". Select from laminate or markerboard top options. An optional book box, approximately 15" W x 11" D x 4-1/2" H, sold separately. Also available is the technology basket for storage of up to 14" laptops or tablets, sold separately. **Quickship available for indicated shapes and sizes in the following laminates: Bannister Oak, Gray Nebula, Fusion Maple, Nepal Teak, Royal Blue, or Markerboard with Black or Titanium T-Mold edge in your choice of any leg height and color.**

**Choose your Premium Elliptical Surface Height Option**

- Adjusts from 15" to 25" or
- Adjusts from 22" to 30" or
- Adjusts from 30" to 43"

Add caster leg inserts to make your table mobile



Top Shape	Product Dimensions	Product Height	Edge Color	Leg Color	Laminate Top			Markerboard Top	
					Item #	Top Color	List Price	Item #	List Price
<b>T-Mold Edge</b>									
Rectangle	36 W x 24 D in	Specify	Specify	Specify	6-1598324-670	Specify	\$279.95	6-1598378-670	\$319.95
Rectangle	48 W x 24 D in	Specify	Specify	Specify	6-1598325-670	Specify	\$312.95	6-1598379-670	\$352.95
Rectangle	60 W x 24 D in	Specify	Specify	Specify	6-1598326-670	Specify	\$346.95	6-1598380-670	\$386.95
Rectangle	72 W x 24 D in	Specify	Specify	Specify	6-1598327-670	Specify	\$379.95	6-1598381-670	\$419.95
Rectangle	48 W x 30 D in	Specify	Specify	Specify	6-1598328-670	Specify	\$332.95	6-1598382-670	\$372.95
Rectangle	60 W x 30 D in	Specify	Specify	Specify	6-1598329-670	Specify	\$359.95	6-1598383-670	\$399.95
Rectangle	72 W x 30 D in	Specify	Specify	Specify	6-1598330-670	Specify	\$386.95	6-1598384-670	\$426.95
Rectangle	84 W x 30 D in	Specify	Specify	Specify	6-1598331-670	Specify	\$412.95	6-1598385-670	\$452.95
Rectangle	96 W x 30 D in	Specify	Specify	Specify	6-1598332-670	Specify	\$439.95	6-1598386-670	\$479.95
Rectangle	60 W x 36 D in	Specify	Specify	Specify	6-1598333-670	Specify	\$386.95	6-1598387-670	\$426.95
Rectangle	72 W x 36 D in	Specify	Specify	Specify	6-1598334-670	Specify	\$412.95	6-1598388-670	\$452.95
Rectangle	60 W x 42 D in	Specify	Specify	Specify	6-1598335-670	Specify	\$412.95	6-1598389-670	\$452.95
Round	36 in	Specify	Specify	Specify	6-1598336-670	Specify	\$306.95	6-1598390-670	\$346.95
Round	42 in	Specify	Specify	Specify	6-1598337-670	Specify	\$332.95	6-1598391-670	\$372.95
Round	48 in	Specify	Specify	Specify	6-1598338-670	Specify	\$359.95	6-1598392-670	\$399.95
Round	60 in	Specify	Specify	Specify	6-1598339-670	Specify	\$412.95	6-1598393-670	\$452.95
Square	36 in	Specify	Specify	Specify	6-1598340-670	Specify	\$306.95	6-1598394-670	\$346.95
Square	42 in	Specify	Specify	Specify	6-1598341-670	Specify	\$332.95	6-1598395-670	\$372.95
Square	48 in	Specify	Specify	Specify	6-1598342-670	Specify	\$359.95	6-1598396-670	\$399.95
Trapezoid	48 x 24 x 24 in	Specify	Specify	Specify	6-1598343-670	Specify	\$306.95	6-1598397-670	\$346.95
Trapezoid	60 x 30 x 30 in	Specify	Specify	Specify	6-1598344-670	Specify	\$332.95	6-1598398-670	\$372.95
Kidney	72 W x 48 D in	Specify	Specify	Specify	6-1598345-670	Specify	\$492.95	6-1598399-670	\$532.95
Kidney	96 W x 48 D in	Specify	Specify	Specify	6-1598346-670	Specify	\$519.95	6-1598400-670	\$559.95
Horseshoe	48 W x 72 D in	Specify	Specify	Specify	6-1598347-670	Specify	\$492.95	6-1598401-670	\$532.95
Horseshoe	60 W x 66 D in	Specify	Specify	Specify	6-1598348-670	Specify	\$519.95	6-1598402-670	\$559.95
Clover	48 W x 48 D in	Specify	Specify	Specify	6-1598349-670	Specify	\$386.95	6-1598403-670	\$426.95
Flower	60 W x 60 D in	Specify	Specify	Specify	6-1598350-670	Specify	\$466.95	6-1598404-670	\$506.95
Half Moon	72 W x 36 D in	Specify	Specify	Specify	6-5004584-670	Specify	\$412.95	6-5004586-670	\$452.95
Half Round	60 W x 30 D in	Specify	Specify	Specify	6-5008742-670	Specify	\$386.95	6-5008737-670	\$426.95
Media	48 W x 72 D in	Specify	Specify	Specify	6-5008755-670	Specify	\$492.95	6-5008744-670	\$532.95
Zoom	48 W x 48 D in	Specify	Specify	Specify	6-5008758-670	Specify	\$359.95	6-5008745-670	\$399.95

Item #	Description	List Price
9-1547618-670	Activity Table Book Box	\$27.95
9-5002704-670	Technology Basket	\$31.95

Item #	Description	List Price
9-2106265-670	Rail Kit w/out Tote <b>NEW</b>	\$79.95
9-2104262-670	Rail Kit with Clear Tote <b>NEW</b>	\$92.95

Item #	Description	List Price
<b>Elliptical Leg Caster Inserts (Set of 2)</b>		
6-1609060-670	Caster Inserts for 22-30" Leg	\$59.95
6-5002713-670	Caster Inserts for 30-43" Leg	\$119.95

Item #	Description	Color	List Price
<b>Additional Power Options</b>			
6-5004132-670	Clamp Mount	Specify	\$366.95
6-5004726-670	Under Table Mount	Specify	\$366.95



Refer to pages 60-61 for color options.



PRODUCT CERTIFIED FOR LOW CHEMICAL EMISSIONS. UL.COM/IGG UL 2818



**Classroom Select® LockEdge® Activity Table with NeoClass® Legs**

These traditional shape tables are perfect for collaborative interaction, encouraging student creativity and learning. Tables with T-Mold edge are made of 1-1/8" particleboard core, and LockEdge® are made of 1-1/8" MDF core and phenolic resin backer. Select from a variety of high pressure laminate top options or markerboard top. Constructed with a galvanized steel stretcher bar attached underneath for extra stability. Premium elliptical NeoClass® leg adjusts the top height from 15" to 25", 22" to 30" or 30" to 43" and come standard with nylon glides. An optional book box, approximately 15" W x 11" D x 4-1/2" H, sold separately. Also add the technology basket as a simple storage solution for up to 14" laptops or tablets, sold separately. Locking casters sold separately. **Quickship available for indicated shapes and sizes in the following laminates: Bannister Oak, Gray Nebula, Fusion Maple, Nepal Teak, Royal Blue, or Markerboard with Black LockEdge® in your choice of any leg height and color.**



Optional Technology Basket sold separately



Optional Activity Table Book Box sold separately

Top Shape	Product Dimensions	Product Height	Edge Color	Leg Color	Laminate Top			Markerboard Top	
					Item #	Top Color	List Price	Item #	List Price
<b>LockEdge®</b>									
Rectangle	36 W x 24 D in	Specify	Specify	Specify	6-1598351-670	Specify	\$379.95	6-1598405-670	\$419.95
Rectangle	48 W x 24 D in	Specify	Specify	Specify	6-1598352-670	Specify	\$412.95	6-1598406-670	\$452.95
Rectangle	60 W x 24 D in	Specify	Specify	Specify	6-1598353-670	Specify	\$446.95	6-1598407-670	\$486.95
Rectangle	72 W x 24 D in	Specify	Specify	Specify	6-1598354-670	Specify	\$479.95	6-1598408-670	\$519.95
Rectangle	48 W x 30 D in	Specify	Specify	Specify	6-1598355-670	Specify	\$432.95	6-1598409-670	\$472.95
Rectangle	60 W x 30 D in	Specify	Specify	Specify	6-1598356-670	Specify	\$459.95	6-1598410-670	\$499.95
Rectangle	72 W x 30 D in	Specify	Specify	Specify	6-1598357-670	Specify	\$486.95	6-1598411-670	\$526.95
Rectangle	84 W x 30 D in	Specify	Specify	Specify	6-1598358-670	Specify	\$512.95	6-1598412-670	\$552.95
Rectangle	96 W x 30 D in	Specify	Specify	Specify	6-1598359-670	Specify	\$539.95	6-1598413-670	\$579.95
Rectangle	60 W x 36 D in	Specify	Specify	Specify	6-1598360-670	Specify	\$486.95	6-1598414-670	\$526.95
Rectangle	72 W x 36 D in	Specify	Specify	Specify	6-1598361-670	Specify	\$512.95	6-1598415-670	\$552.95
Rectangle	60 W x 42 D in	Specify	Specify	Specify	6-1598362-670	Specify	\$512.95	6-1598416-670	\$552.95
Round	36 in	Specify	Specify	Specify	6-1598363-670	Specify	\$406.95	6-1598417-670	\$446.95
Round	42 in	Specify	Specify	Specify	6-1598364-670	Specify	\$432.95	6-1598418-670	\$472.95
Round	48 in	Specify	Specify	Specify	6-1598365-670	Specify	\$459.95	6-1598419-670	\$499.95
Round	60 in	Specify	Specify	Specify	6-1598366-670	Specify	\$512.95	6-1598420-670	\$552.95
Square	36 in	Specify	Specify	Specify	6-1598367-670	Specify	\$406.95	6-1598421-670	\$446.95
Square	42 in	Specify	Specify	Specify	6-1598368-670	Specify	\$432.95	6-1598422-670	\$472.95
Square	48 in	Specify	Specify	Specify	6-1598369-670	Specify	\$459.95	6-1598423-670	\$499.95
Trapezoid	48 x 24 x 24 in	Specify	Specify	Specify	6-1598370-670	Specify	\$406.95	6-1598424-670	\$446.95
Trapezoid	60 x 30 x 30 in	Specify	Specify	Specify	6-1598371-670	Specify	\$432.95	6-1598425-670	\$472.95
Kidney	72 W x 48 D in	Specify	Specify	Specify	6-1598372-670	Specify	\$592.95	6-1598426-670	\$632.95
Kidney	96 W x 48 D in	Specify	Specify	Specify	6-1598373-670	Specify	\$619.95	6-1598427-670	\$659.95
Horseshoe	48 W x 72 D in	Specify	Specify	Specify	6-1598374-670	Specify	\$592.95	6-1598428-670	\$632.95
Horseshoe	60 W x 66 D in	Specify	Specify	Specify	6-1598375-670	Specify	\$619.95	6-1598429-670	\$659.95
Clover	48 W x 48 D in	Specify	Specify	Specify	6-1598376-670	Specify	\$486.95	6-1598430-670	\$526.95
Flower	60 W x 60 D in	Specify	Specify	Specify	6-1598377-670	Specify	\$566.95	6-1598431-670	\$606.95
Half Moon	72 W x 36 D in	Specify	Specify	Specify	6-5004585-670	Specify	\$512.95	6-5004587-670	\$552.95
Half Round	60 W x 30 D in	Specify	Specify	Specify	6-5008734-670	Specify	\$486.95	6-5008735-670	\$526.95
Media	48 W x 72 D in	Specify	Specify	Specify	6-5008765-670	Specify	\$632.95	6-5008751-670	\$592.95
Zoom	48 W x 48 D in	Specify	Specify	Specify	6-5008748-670	Specify	\$459.95	6-5008759-670	\$499.95

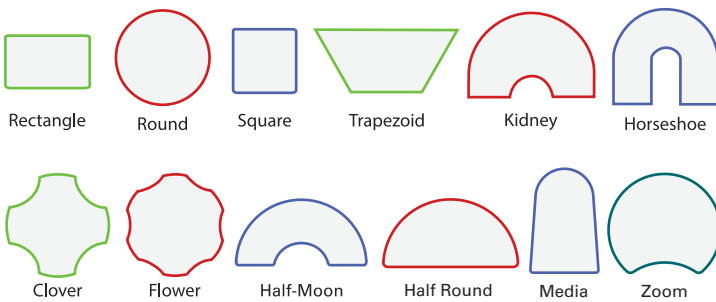

Item #	Description	Color	List Price
<b>Elliptical Leg Caster Inserts (Set of 2)</b>			
6-1609060-670	Caster Inserts for 22-30" Leg		\$59.95
6-5002713-670	Caster Inserts for 30-43" Leg		\$119.95
<b>Additional Power Options</b>			
6-5004132-670	Clamp Mount	Specify	\$366.95
6-5004726-670	Under Table Mount	Specify	\$366.95
<b>Item # Description List Price</b>			
9-1547618-670	Activity Table Book Box		\$27.95
9-5002704-670	Technology Basket		\$31.95
<b>Item # Description List Price</b>			
9-2106265-670	Rail Kit w/out Tote		\$79.95
9-2104262-670	Rail Kit with Clear Tote		\$92.95

CLASSROOM  
SELECT 



PRODUCT CERTIFIED  
FOR LOW CHEMICAL  
EMISSIONS:  
UL CQM/IGG  
UL 2918



PLEASE  
SPECIFY  
COLOR  
CHOICE

Refer to pages 60-61  
for color options.



Flower

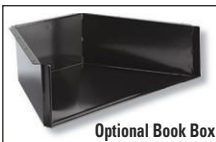

Optional Book Box



Tote Rail without Tote



Features 2" round,  
17-gauge steel Apollo® legs

**Classroom Select® Activity Table with Apollo® Legs**

Combining contemporary looks, functionality, and flexibility creates an ideal learning environment for student collaboration and interaction. Featuring the Apollo® leg, designed with 2" round, 17-gauge steel, available in 11" to 17", 15" to 25", and 22" to 30" adjustable height ranges and a variety of colors. Table legs come standard with nylon glides. Table tops are constructed from a 1-1/8" particleboard core with a high pressure laminate surface. Tables 60" or longer have a 20-gauge steel stretcher bar underneath the top for added structural strength to prevent sagging. A quick-set leg system offers easy installation and assembly. Available with an optional black metal book box, approximately 15" W x 11" D x 4-1/2" H, sold separately. Also add the Classroom Select® Technology Basket for a simple storage solution for up to 14" laptops or tablets. Easy to install tote rail system available for your storage needs. Locking caster options available.

**Quickship available for indicated shapes and sizes in laminate colors of Bannister Oak, Gray Nebula, Fusion Maple, Nepal Teak, Royal Blue, or Markerboard with Black or Titanium T-Mold edge, or Black LockEdge® in your choice of any leg height and color.**

**24-hr Quickship** available for items 1496659, 1496663 and 1496678 with Gray Nebula or Bannister Oak Tops and Black T-mold edge, in your choice of any leg height and color. Quantities not to exceed 10 each. Applies to orders containing 24 hr quickship items only.

Top Shape	Product Dimensions	Product Height	Edge Color	Leg Color	Laminate Top			Markerboard Top	
					Item #	Top Color	List Price	Item #	List Price
<b>T-Mold Edge</b>									
Rectangle	36 W x 24 D in	Specify	Specify	Specify	6-1496658-670	Specify	\$246.95	6-1496734-670	\$286.95
Rectangle	48 W x 24 D in	Specify	Specify	Specify	6-1496659-670	Specify	\$279.95	6-1496735-670	\$319.95
Rectangle	60 W x 24 D in	Specify	Specify	Specify	6-1496660-670	Specify	\$312.95	6-1496736-670	\$352.95
Rectangle	72 W x 24 D in	Specify	Specify	Specify	6-1496661-670	Specify	\$346.95	6-1496737-670	\$386.95
Rectangle	48 W x 30 D in	Specify	Specify	Specify	6-1496662-670	Specify	\$299.95	6-1496738-670	\$339.95
Rectangle	60 W x 30 D in	Specify	Specify	Specify	6-1496663-670	Specify	\$326.95	6-1496739-670	\$366.95
Rectangle	72 W x 30 D in	Specify	Specify	Specify	6-1496664-670	Specify	\$352.95	6-1496740-670	\$392.95
Rectangle	84 W x 30 D in	Specify	Specify	Specify	6-1496665-670	Specify	\$379.95	6-1496741-670	\$419.95
Rectangle	96 W x 30 D in	Specify	Specify	Specify	6-1496666-670	Specify	\$406.95	6-1496742-670	\$446.95
Rectangle	60 W x 36 D in	Specify	Specify	Specify	6-1496667-670	Specify	\$352.95	6-1496743-670	\$392.95
Rectangle	72 W x 36 D in	Specify	Specify	Specify	6-1496668-670	Specify	\$379.95	6-1496744-670	\$419.95
Rectangle	60 W x 42 D in	Specify	Specify	Specify	6-1496669-670	Specify	\$379.95	6-1496745-670	\$419.95
Round	36 in	Specify	Specify	Specify	6-1496670-670	Specify	\$272.95	6-1496746-670	\$312.95
Round	42 in	Specify	Specify	Specify	6-1496671-670	Specify	\$299.95	6-1496747-670	\$339.95
Round	48 in	Specify	Specify	Specify	6-1496672-670	Specify	\$326.95	6-1496748-670	\$366.95
Round	60 in	Specify	Specify	Specify	6-1496673-670	Specify	\$379.95	6-1496749-670	\$419.95
Square	36 in	Specify	Specify	Specify	6-1496674-670	Specify	\$272.95	6-1496750-670	\$312.95
Square	42 in	Specify	Specify	Specify	6-1496675-670	Specify	\$299.95	6-1496751-670	\$339.95
Square	48 in	Specify	Specify	Specify	6-1496676-670	Specify	\$326.95	6-1496752-670	\$366.95
Trapezoid	48 x 24 x 24 in	Specify	Specify	Specify	6-1496677-670	Specify	\$272.95	6-1496753-670	\$312.95
Trapezoid	60 x 30 x 30 in	Specify	Specify	Specify	6-1496678-670	Specify	\$299.95	6-1496754-670	\$339.95
Kidney	72 W x 48 D in	Specify	Specify	Specify	6-1496679-670	Specify	\$459.95	6-1496755-670	\$499.95
Kidney	96 W x 48 D in	Specify	Specify	Specify	6-1496680-670	Specify	\$486.95	6-1496756-670	\$526.95
Horseshoe	48 W x 72 D in	Specify	Specify	Specify	6-1496681-670	Specify	\$459.95	6-1496757-670	\$499.95
Horseshoe	60 W x 66 D in	Specify	Specify	Specify	6-1496682-670	Specify	\$486.95	6-1496758-670	\$526.95
Clover	48 W x 48 D in	Specify	Specify	Specify	6-1496683-670	Specify	\$352.95	6-1496759-670	\$392.95
Flower	60 W x 60 D in	Specify	Specify	Specify	6-1496684-670	Specify	\$432.95	6-1496760-670	\$472.95
Half Moon	72 W x 36 D in	Specify	Specify	Specify	6-5004580-670	Specify	\$379.95	6-5004582-670	\$419.95
Half Round	60 W x 30 D in	Specify	Specify	Specify	6-5008738-670	Specify	\$352.95	6-5008747-670	\$392.95
Media	48 W x 72 D in	Specify	Specify	Specify	6-5008761-670	Specify	\$459.95	6-5008766-670	\$499.95
Zoom	48 W x 48 D in	Specify	Specify	Specify	6-5008764-670	Specify	\$326.95	6-5008763-670	\$366.95

Item #	Description	List Price
9-1547618-670	Activity Table Book Box	\$27.95
9-5002704-670	Technology Basket	\$31.95
Item #	Description	List Price
9-2106265-670	Rail Kit w/out Tote	\$79.95
9-2104262-670	Rail Kit with Clear Tote	\$92.95

Item #	Description	Color	List Price
Additional Power Options			
6-5004132-670	Clamp Mount	Specify	\$366.95
6-5004726-670	Under Table Mount	Specify	\$366.95



PLEASE SPECIFY COLOR CHOICE  
Refer to pages 60-61 for color options.



CLASSROOM SELECT



Tote Rail with Tote



Under Table Mount



Optional Technology Basket

### Classroom Select® Activity Table with Apollo® Legs

Combining contemporary looks, functionality, and flexibility creates an ideal learning environment for student collaboration and interaction. Featuring the Apollo® leg, designed with 2" round, 17-gauge steel, available in 11" to 17", 15" to 25", and 22" to 30" adjustable height ranges and a variety of colors. Table legs come standard with nylon glides. Table tops are constructed from a 1-1/8" particleboard core with a high pressure laminate surface. Tables 60" or longer have a 20-gauge steel stretcher bar underneath the top for added structural strength to prevent sagging. A quick-set leg system offers easy installation and assembly. Available with an optional black metal book box, approximately 15" W x 11" D x 4-1/2" H, sold separately. Also add the Classroom Select® Technology Basket for a simple storage solution for up to 14" laptops or tablets. Easy to install tote rail system available for your storage needs. Locking caster options available. **Quickship available for indicated shapes and sizes in laminate colors of Bannister Oak, Gray Nebula, Fusion Maple, Nepal Teak, Royal Blue, or Markerboard with Black or Titanium T-Mold edge, or Black LockEdge® in your choice of any leg height and color.**

Top Shape	Product Dimensions	Product Height	Edge Color	Leg Color	Laminate Top			Markerboard Top	
					Item #	Top Color	List Price	Item #	List Price
LockEdge®									
Rectangle	36 W x 24 D in	Specify	Specify	Specify	6-1496685-670	Specify	\$346.95	6-1496761-670	\$386.95
Rectangle	48 W x 24 D in	Specify	Specify	Specify	6-1496686-670	Specify	\$379.95	6-1496762-670	\$419.95
Rectangle	60 W x 24 D in	Specify	Specify	Specify	6-1496687-670	Specify	\$412.95	6-1496763-670	\$452.95
Rectangle	72 W x 24 D in	Specify	Specify	Specify	6-1496688-670	Specify	\$446.95	6-1496764-670	\$486.95
Rectangle	48 W x 30 D in	Specify	Specify	Specify	6-1496689-670	Specify	\$399.95	6-1496765-670	\$439.95
Rectangle	60 W x 30 D in	Specify	Specify	Specify	6-1496690-670	Specify	\$426.95	6-1496766-670	\$466.95
Rectangle	72 W x 30 D in	Specify	Specify	Specify	6-1496691-670	Specify	\$452.95	6-1496767-670	\$492.95
Rectangle	84 W x 30 D in	Specify	Specify	Specify	6-1496692-670	Specify	\$479.95	6-1496768-670	\$519.95
Rectangle	96 W x 30 D in	Specify	Specify	Specify	6-1496693-670	Specify	\$506.95	6-1496769-670	\$546.95
Rectangle	60 W x 36 D in	Specify	Specify	Specify	6-1496694-670	Specify	\$452.95	6-1496770-670	\$492.95
Rectangle	72 W x 36 D in	Specify	Specify	Specify	6-1496695-670	Specify	\$479.95	6-1496771-670	\$519.95
Rectangle	60 W x 42 D in	Specify	Specify	Specify	6-1496696-670	Specify	\$479.95	6-1496772-670	\$519.95
Round	36 in	Specify	Specify	Specify	6-1496697-670	Specify	\$372.95	6-1496773-670	\$412.95
Round	42 in	Specify	Specify	Specify	6-1496698-670	Specify	\$399.95	6-1496774-670	\$439.95
Round	48 in	Specify	Specify	Specify	6-1496699-670	Specify	\$426.95	6-1496775-670	\$466.95
Round	60 in	Specify	Specify	Specify	6-1496700-670	Specify	\$479.95	6-1496776-670	\$519.95
Square	36 in	Specify	Specify	Specify	6-1496701-670	Specify	\$372.95	6-1496777-670	\$412.95
Square	42 in	Specify	Specify	Specify	6-1496702-670	Specify	\$399.95	6-1496778-670	\$439.95
Square	48 in	Specify	Specify	Specify	6-1496703-670	Specify	\$426.95	6-1496779-670	\$466.95
Trapezoid	48 x 24 x 24 in	Specify	Specify	Specify	6-1496704-670	Specify	\$372.95	6-1496780-670	\$412.95
Trapezoid	60 x 30 x 30 in	Specify	Specify	Specify	6-1496705-670	Specify	\$399.95	6-1496781-670	\$439.95
Kidney	72 W x 48 D in	Specify	Specify	Specify	6-1496706-670	Specify	\$559.95	6-1496782-670	\$599.95
Kidney	96 W x 48 D in	Specify	Specify	Specify	6-1496707-670	Specify	\$586.95	6-1496783-670	\$626.95
Horseshoe	48 W x 72 D in	Specify	Specify	Specify	6-1496708-670	Specify	\$559.95	6-1496784-670	\$599.95
Horseshoe	60 W x 66 D in	Specify	Specify	Specify	6-1496709-670	Specify	\$586.95	6-1496785-670	\$626.95
Clover	48 W x 48 D in	Specify	Specify	Specify	6-1496710-670	Specify	\$452.95	6-1496786-670	\$492.95
Flower	60 W x 60 D in	Specify	Specify	Specify	6-1496711-670	Specify	\$532.95	6-1496787-670	\$572.95
Half Moon	72 W x 36 D in	Specify	Specify	Specify	6-5004581-670	Specify	\$479.95	6-5004583-670	\$519.95
Half Round	60 W x 30 D in	Specify	Specify	Specify	6-5008741-670	Specify	\$452.95	6-5008750-670	\$492.95
Media	48 W x 72 D in	Specify	Specify	Specify	6-5008749-670	Specify	\$559.95	6-5008756-670	\$599.95
Zoom	48 W x 48 D in	Specify	Specify	Specify	6-5008754-670	Specify	\$426.95	6-5008752-670	\$466.95

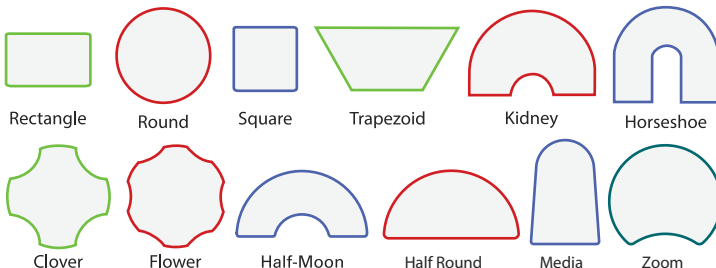

Item #	Description	Color	List Price
6-5004132-670	Clamp Mount	Specify	\$366.95
6-5004726-670	Under Table Mount	Specify	\$366.95
Item #	Description		List Price
6-1563290-670	Apollo Leg Caster Inserts (2)		\$59.95
Item #	Description		List Price
9-1547618-670	Activity Table Book Box		\$27.95
9-5002704-670	Technology Basket		\$31.95
Item #	Description		List Price
9-2106265-670	Rail Kit w/out Tote		\$79.95
9-2104262-670	Rail Kit with Clear Tote		\$92.95

**CLASSROOM  
SELECT**



PRODUCT CERTIFIED  
FOR LOW CHEMICAL  
EMISSIONS:  
UL.COM/SGG  
UL 2818



**PLEASE  
SPECIFY  
COLOR  
CHOICE**

Refer to pages 60 - 61  
for color options.



**Clover**



**Half-Moon**



**Rectangle with  
Markerboard Top**

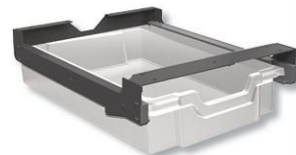

**Tote Rail with Tote**

**Classroom Select® Activity Table with Standard Legs**

Cafeterias, libraries, and meeting rooms all require tables in different sizes, colors, shapes, and heights. Classroom Select® provides high quality activity tables to meet your needs, backed by a limited lifetime warranty because we use only the highest quality, tested, and approved components. Available in 15" to 25" and 22" to 30" adjustable-height ranges. Select from T-Mold edge, or LockEdge® for added durability. T-Mold tabletops are constructed from a 1-1/8" solid core, and LockEdge® tabletops are made from a 1-1/8" MDF core. Available in a variety of high pressure laminate tops and markerboard. An optional black metal book box, approximately 15W x 11D, 4-1/2" H, sold separately. Additional optional accessories, including clamp mount power module, tote rail storage, and a technology basket, sold separately.

**Quickship available for indicated shapes and sizes in Bannister Oak, Gray Nebula, or Royal Blue laminate with black edge / leg uppers, in your choice of 22"-30" or 15"-24" leg height.**

**T-Mold Activity Tables**

Top Shape	Product Dimensions	Product Height	Edge Color	Leg Color	Laminate Top			Markerboard Top	
					Item #	Top Color	List Price	Item #	List Price
Rectangle	36 W x 24 D in	Specify	Specify	Specify	6-1334848-670	Specify	\$199.95	6-1497051-670	\$239.95
Rectangle	48 W x 24 D in	Specify	Specify	Specify	6-1334849-670	Specify	\$232.95	6-1497052-670	\$272.95
Rectangle	60 W x 24 D in	Specify	Specify	Specify	6-1334850-670	Specify	\$266.95	6-1497053-670	\$306.95
Rectangle	72 W x 24 D in	Specify	Specify	Specify	6-1457635-670	Specify	\$299.95	6-1497054-670	\$339.95
Rectangle	48 W x 30 D in	Specify	Specify	Specify	6-1334852-670	Specify	\$252.95	6-1497055-670	\$292.95
Rectangle	60 W x 30 D in	Specify	Specify	Specify	6-1334853-670	Specify	\$279.95	6-1497056-670	\$319.95
Rectangle	72 W x 30 D in	Specify	Specify	Specify	6-1334854-670	Specify	\$306.95	6-1497057-670	\$346.95
Rectangle	84 W x 30 D in	Specify	Specify	Specify	6-1457636-670	Specify	\$332.95	6-1497058-670	\$372.95
Rectangle	96 W x 30 D in	Specify	Specify	Specify	6-1457637-670	Specify	\$359.95	6-1497059-670	\$399.95
Rectangle	60 W x 36 D in	Specify	Specify	Specify	6-1334857-670	Specify	\$306.95	6-1497060-670	\$346.95
Rectangle	72 W x 36 D in	Specify	Specify	Specify	6-1334858-670	Specify	\$332.95	6-1497061-670	\$372.95
Rectangle	60 W x 42 D in	Specify	Specify	Specify	6-1334860-670	Specify	\$332.95	6-1497062-670	\$372.95
Round	36 in	Specify	Specify	Specify	6-1334855-670	Specify	\$226.95	6-1497063-670	\$266.95
Round	42 in	Specify	Specify	Specify	6-1334859-670	Specify	\$252.95	6-1497064-670	\$292.95
Round	48 in	Specify	Specify	Specify	6-1334862-670	Specify	\$279.95	6-1497065-670	\$319.95
Round	60 in	Specify	Specify	Specify	6-1334867-670	Specify	\$332.95	6-1497066-670	\$372.95
Square	36 in	Specify	Specify	Specify	6-1334856-670	Specify	\$226.95	6-1497067-670	\$266.95
Square	42 in	Specify	Specify	Specify	6-1457638-670	Specify	\$252.95	6-1497068-670	\$292.95
Square	48 in	Specify	Specify	Specify	6-1334863-670	Specify	\$279.95	6-1497069-670	\$319.95
Trapezoid	48 x 24 x 24 in	Specify	Specify	Specify	6-1334847-670	Specify	\$226.95	6-1497211-670	\$266.95
Trapezoid	60 x 30 x 30 in	Specify	Specify	Specify	6-1334851-670	Specify	\$252.95	6-1497212-670	\$292.95
Kidney	72 W x 48 D in	Specify	Specify	Specify	6-1334865-670	Specify	\$412.95	6-1497070-670	\$452.95
Kidney	96 W x 48 D in	Specify	Specify	Specify	6-1457639-670	Specify	\$439.95	6-1497071-670	\$479.95
Horseshoe	48 W x 72 D in	Specify	Specify	Specify	6-1334864-670	Specify	\$412.95	6-1497072-670	\$452.95
Horseshoe	60 W x 66 D in	Specify	Specify	Specify	6-1334868-670	Specify	\$439.95	6-1497073-670	\$479.95
Clover	48 W x 48 D in	Specify	Specify	Specify	6-1334861-670	Specify	\$306.95	6-1497074-670	\$346.95
Flower	60 W x 60 D in	Specify	Specify	Specify	6-1334866-670	Specify	\$386.95	6-1497075-670	\$426.95
Half Moon	72 W x 36 D in	Specify	Specify	Specify	6-5004576-670	Specify	\$332.95	6-5004578-670	\$372.95
Half Round	60 W x 30 D in	Specify	Specify	Specify	6-5008736-670	Specify	\$306.95	6-5008733-670	\$346.95
Media	48 W x 72 D in	Specify	Specify	Specify	6-5008743-670	Specify	\$412.95	6-5008762-670	\$452.95
Zoom	48 W x 48 D in	Specify	Specify	Specify	6-5008753-670	Specify	\$279.95	6-5008767-670	\$319.95

Item #	Description	List Price
9-1547618-670	Activity Table Book Box	\$27.95
9-5002704-670	Technology Basket	\$31.95

Additional Power Options		
6-5004132-670	Clamp Mount	\$366.95
6-5004726-670	Under Table Mount	\$366.95

Item #	Description	List Price
9-2106265-670	Rail Kit w/out Tote	\$79.95
9-2104262-670	Rail Kit with Clear Tote	\$92.95

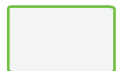

Rectangle



Round



Square



Trapezoid



Kidney



Horseshoe



Clover



Flower



Half-Moon



Half Round



Media



Zoom



Refer to pages 60 - 61 for color options.



PRODUCT CERTIFIED FOR LOW CHEMICAL EMISSIONS: UL COMGG UL 2918



CLASSROOM SELECT 



Flower



Rectangle

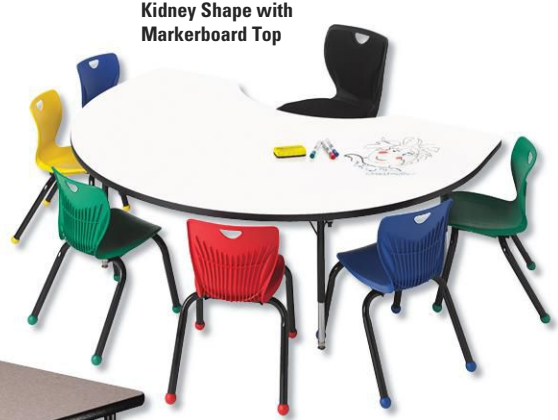

Kidney Shape with Markerboard Top



Optional metal book box sold separately.

LockEdge® Activity Tables

Top Shape	Product Dimensions	Product Height	Edge Color	Leg Color	Laminate Top			Markerboard Top	
					Item #	Top Color	List Price	Item #	List Price
Rectangle	36 W x 24 D in	Specify	Specify	Specify	6-1362565-670	Specify	\$299.95	6-1497076-670	\$339.95
Rectangle	48 W x 24 D in	Specify	Specify	Specify	6-1362566-670	Specify	\$332.95	6-1497077-670	\$372.95
Rectangle	60 W x 24 D in	Specify	Specify	Specify	6-1362568-670	Specify	\$366.95	6-1497078-670	\$406.95
Rectangle	72 W x 24 D in	Specify	Specify	Specify	6-1362569-670	Specify	\$399.95	6-1497079-670	\$439.95
Rectangle	48 W x 30 D in	Specify	Specify	Specify	6-1362570-670	Specify	\$352.95	6-1497080-670	\$392.95
Rectangle	60 W x 30 D in	Specify	Specify	Specify	6-1362571-670	Specify	\$379.95	6-1497081-670	\$419.95
Rectangle	72 W x 30 D in	Specify	Specify	Specify	6-1362573-670	Specify	\$406.95	6-1497082-670	\$446.95
Rectangle	84 W x 30 D in	Specify	Specify	Specify	6-1362574-670	Specify	\$432.95	6-1497083-670	\$472.95
Rectangle	96 W x 30 D in	Specify	Specify	Specify	6-1362575-670	Specify	\$459.95	6-1497084-670	\$499.95
Rectangle	60 W x 36 D in	Specify	Specify	Specify	6-1362577-670	Specify	\$406.95	6-1497085-670	\$446.95
Rectangle	72 W x 36 D in	Specify	Specify	Specify	6-1362578-670	Specify	\$432.95	6-1497086-670	\$472.95
Rectangle	60 W x 42 D in	Specify	Specify	Specify	6-1362581-670	Specify	\$432.95	6-1497087-670	\$472.95
Round	36 in	Specify	Specify	Specify	6-1362579-670	Specify	\$326.95	6-1497088-670	\$366.95
Round	42 in	Specify	Specify	Specify	6-1362582-670	Specify	\$352.95	6-1497089-670	\$392.95
Round	48 in	Specify	Specify	Specify	6-1362583-670	Specify	\$379.95	6-1497090-670	\$419.95
Round	60 in	Specify	Specify	Specify	6-1362589-670	Specify	\$432.95	6-1497091-670	\$472.95
Square	36 in	Specify	Specify	Specify	6-1362576-670	Specify	\$326.95	6-1497092-670	\$366.95
Square	42 in	Specify	Specify	Specify	6-1362580-670	Specify	\$352.95	6-1497093-670	\$392.95
Square	48 in	Specify	Specify	Specify	6-1362583-670	Specify	\$379.95	6-1497094-670	\$419.95
Trapezoid	48 x 24 x 24 in	Specify	Specify	Specify	6-1362567-670	Specify	\$326.95	6-1497095-670	\$366.95
Trapezoid	60 x 30 x 30 in	Specify	Specify	Specify	6-1362572-670	Specify	\$352.95	6-1497096-670	\$392.95
Kidney	72 W x 48 D in	Specify	Specify	Specify	6-1362834-670	Specify	\$512.95	6-1497097-670	\$552.95
Kidney	96 W x 48 D in	Specify	Specify	Specify	6-1362584-670	Specify	\$539.95	6-1497098-670	\$579.95
Horseshoe	48 W x 72 D in	Specify	Specify	Specify	6-1457640-670	Specify	\$512.95	6-1497099-670	\$552.95
Horseshoe	60 W x 66 D in	Specify	Specify	Specify	6-1362587-670	Specify	\$539.95	6-1497100-670	\$579.95
Clover	48 W x 48 D in	Specify	Specify	Specify	6-1362585-670	Specify	\$406.95	6-1497101-670	\$446.95
Flower	60 W x 60 D in	Specify	Specify	Specify	6-1362588-670	Specify	\$486.95	6-1497102-670	\$526.95
Half Moon	72 W x 36 D in	Specify	Specify	Specify	6-5004577-670	Specify	\$432.95	6-5004579-670	\$472.95
Half Round	60 W x 30 D in	Specify	Specify	Specify	6-5008732-670	Specify	\$406.95	6-5008740-670	\$446.95
Media	48 W x 72 D in	Specify	Specify	Specify	6-5008757-670	Specify	\$512.95	6-5008760-670	\$552.95
Zoom	48 W x 48 D in	Specify	Specify	Specify	6-5008739-670	Specify	\$379.95	6-5008746-670	\$419.95

24-hr Quickship available for items 1334849, 1334853 and 1334851 with Gray Nebula or Bannister Oak Tops and Black T-mold edge, in your choice of any leg height and color. Quantities not to exceed 10 each. Applies to orders containing 24 hr quickship items only.

**CLASSROOM  
SELECT**



PRODUCT CERTIFIED FOR LOW CHEMICAL EMISSIONS:  
UL.COM/IGG  
UL 2818



Refer to pages 60-61 for color options.



**Square Leg**



**Round Leg**

**Classroom Select® Vigor® T-Mold Utility Table**

This versatile heavy-duty utility table is perfect for project learning environments; especially STEAM/STEM, Art, Science, and Robotic classrooms. Tables with T-Mold edge band are made of 1-1/8" particleboard core. Choose from 14-gauge 2" square legs or 2" round legs both adjustable from 29" to 42" height and standard with a nylon glide. The durable unitized frame is black powdercoat with a solid steel apron providing the ultimate strength and support for any project. Optional locking casters available on request.

Top Shape	Product Dimensions	Edge Color	Leg Style	Laminate Top			Markerboard Top	
				Item #	Top Color	List Price	Item #	List Price
Rectangle	48 W x 24 D in	Specify	Specify	6-5003664-670	Specify	\$599.95	6-5003652-670	\$646.95
Rectangle	60 W x 24 D in	Specify	Specify	6-5003665-670	Specify	\$612.95	6-5003699-670	\$659.95
Rectangle	72 W x 24 D in	Specify	Specify	6-5003702-670	Specify	\$626.95	6-5003673-670	\$672.95
Rectangle	48 W x 30 D in	Specify	Specify	6-5003672-670	Specify	\$612.95	6-5003661-670	\$659.95
Rectangle	60 W x 30 D in	Specify	Specify	6-5003671-670	Specify	\$626.95	6-5003662-670	\$672.95
Rectangle	72 W x 30 D in	Specify	Specify	6-5003709-670	Specify	\$639.95	6-5003701-670	\$686.95
Rectangle	60 W x 36 D in	Specify	Specify	6-5003695-670	Specify	\$639.95	6-5003683-670	\$686.95
Round	36 in	Specify	Specify	6-5003690-670	Specify	\$612.95	6-5003718-670	\$659.95
Round	42 in	Specify	Specify	6-5003689-670	Specify	\$626.95	6-5003681-670	\$672.95
Round	48 in	Specify	Specify	6-5003723-670	Specify	\$639.95	6-5003658-670	\$686.95
Round	60 in	Specify	Specify	6-5003670-670	Specify	\$666.95	6-5003726-670	\$712.95
Square	36 in	Specify	Specify	6-5003703-670	Specify	\$612.95	6-5003696-670	\$659.95
Square	42 in	Specify	Specify	6-5003669-670	Specify	\$626.95	6-5003725-670	\$672.95
Square	48 in	Specify	Specify	6-5003697-670	Specify	\$639.95	6-5003719-670	\$686.95
Trapezoid	24 x 24 x 48 in	Specify	Specify	6-5003724-670	Specify	\$626.95	6-5003655-670	\$672.95
Trapezoid	30 x 30 x 60 in	Specify	Specify	6-5003656-670	Specify	\$652.95	6-5003678-670	\$699.95
Kidney	72 W x 48 D in	Specify	Specify	6-5003676-670	Specify	\$866.95	6-5003663-670	\$912.95
Kidney	96 W x 48 D in	Specify	Specify	6-5003657-670	Specify	\$932.95	6-5003644-670	\$979.95
Horseshoe	72 W x 48 D in	Specify	Specify	6-5003650-670	Specify	\$866.95	6-5003668-670	\$912.95
Horseshoe	66 W x 60 D in	Specify	Specify	6-5003647-670	Specify	\$932.95	6-5003649-670	\$979.95
Clover	48 W x 48 D in	Specify	Specify	6-5003707-670	Specify	\$639.95	6-5003654-670	\$686.95

Item #	Description	List Price
9-2040212-670	Table Casters - Set of 4	\$30.95

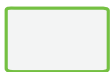

Rectangle

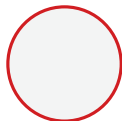

Round



Square

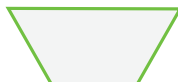

Trapezoid



Kidney



Horseshoe

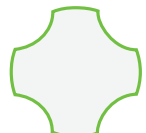

Clover





Refer to pages 60-61 for color options.



PRODUCT CERTIFIED FOR LOW CHEMICAL EMISSIONS: UL.COM/IGG UL 2818



**Square Leg**



**Round Leg**

**Classroom Select® Vigor® LockEdge® Utility Table**

This versatile heavy-duty utility table is perfect for project learning environments; especially STEAM/STEM, Art, Science, and Robotic classrooms. Tables with LockEdge® banding are made of 1-1/8" MDF core with durable high pressure laminate top and phenolic resin backer. Choose from 14-gauge 2" square legs or 2" round legs both adjustable from 29" to 42" height. The durable unitized frame is black powdercoat with a solid steel apron providing the ultimate strength and support for any project.

Top Shape	Product Dimensions	Edge Color	Leg Style	Laminate Top			Markerboard Top	
				Item #	Top Color	List Price	Item #	List Price
Rectangle	48 W x 24 D in	Specify	Specify	6-5003684-670	Specify	\$666.95	6-5003721-670	\$712.95
Rectangle	60 W x 24 D in	Specify	Specify	6-5003660-670	Specify	\$679.95	6-5003704-670	\$726.95
Rectangle	72 W x 24 D in	Specify	Specify	6-5003682-670	Specify	\$692.95	6-5003674-670	\$739.95
Rectangle	48 W x 30 D in	Specify	Specify	6-5003717-670	Specify	\$679.95	6-5003685-670	\$726.95
Rectangle	60 W x 30 D in	Specify	Specify	6-5003667-670	Specify	\$692.95	6-5003714-670	\$739.95
Rectangle	72 W x 30 D in	Specify	Specify	6-5003705-670	Specify	\$706.95	6-5003692-670	\$752.95
Rectangle	60 W x 36 D in	Specify	Specify	6-5003693-670	Specify	\$706.95	6-5003710-670	\$752.95
Round	36 in	Specify	Specify	6-5003708-670	Specify	\$679.95	6-5003716-670	\$726.95
Round	42 in	Specify	Specify	6-5003694-670	Specify	\$692.95	6-5003715-670	\$739.95
Round	48 in	Specify	Specify	6-5003713-670	Specify	\$706.95	6-5003711-670	\$752.95
Round	60 in	Specify	Specify	6-5003691-670	Specify	\$732.95	6-5003675-670	\$779.95
Square	36 in	Specify	Specify	6-5003698-670	Specify	\$679.95	6-5003720-670	\$726.95
Square	42 in	Specify	Specify	6-5003643-670	Specify	\$692.95	6-5003680-670	\$739.95
Square	48 in	Specify	Specify	6-5003666-670	Specify	\$706.95	6-5003712-670	\$752.95
Trapezoid	24 x 24 x 48 in	Specify	Specify	6-5003700-670	Specify	\$692.95	6-5003706-670	\$739.95
Trapezoid	30 x 30 x 60 in	Specify	Specify	6-5003688-670	Specify	\$719.95	6-5003722-670	\$766.95
Kidney	72 W x 48 D in	Specify	Specify	6-5003679-670	Specify	\$932.95	6-5003648-670	\$979.95
Kidney	96 W x 48 D in	Specify	Specify	6-5003645-670	Specify	\$999.95	6-5003687-670	\$1,046.95
Horseshoe	72 W x 48 D in	Specify	Specify	6-5003653-670	Specify	\$932.95	6-5003677-670	\$979.95
Horseshoe	66 W x 60 D in	Specify	Specify	6-5003651-670	Specify	\$999.95	6-5003686-670	\$1,046.95
Clover	48 W x 48 D in	Specify	Specify	6-5003642-670	Specify	\$706.95	6-5003659-670	\$752.95
<b>Item #</b>	<b>Description</b>					<b>List Price</b>		
9-2040212-670	Table Casters - Set of 4					\$30.95		



PLEASE SPECIFY COLOR CHOICE  
Refer to pages 60-61 for color options.



Rectangle Laminate T-Mold



Square Laminate LockEdge with Shelves



Rectangle Markerboard T-Mold



Rectangle Butcher Block with Shelves

### Classroom Select® Construct-IT® Makerspace Utility Project Center

The perfect companion to the Geode Series® storage cabinets, the Construct-IT® is built like a rock with a durable steel frame and side panels available in 11 vibrant color options to make any room shine. Super heavy-duty, 4-inch zinc alloy casters, 2 locking and 2 non-locking, provide smooth and reliable transportation. Side panels feature rows of peg board perforation for increased storage potential. **Durable steel shelving units can be purchased as an accessory for added storage space.** Table tops are offered in a variety of sizes to fit any of your work area needs as well as laminate, markerboard, and butcher block options. Our uniquely engineered frames are height adjustable from 29" to 42" in 1" increments allowing you to choose a sitting or standing worksurface.

Item #	Product Dimensions	Top Type	Top Color	Edge Color	Panel Color	List Price
<b>Laminate with T-Mold</b>						
6-5004240-670	42 in	Laminate	Specify	Specify	Specify	\$892.95
6-5004243-670	48W x 30D in	Laminate	Specify	Specify	Specify	\$866.95
6-5004241-670	60W x 30D in	Laminate	Specify	Specify	Specify	\$919.95
6-5004242-670	72W x 30D in	Laminate	Specify	Specify	Specify	\$946.95
6-5004244-670	60W x 36D in	Laminate	Specify	Specify	Specify	\$946.95
6-5004245-670	72W x 36D in	Laminate	Specify	Specify	Specify	\$972.95
<b>Laminate with LockEdge®</b>						
6-5004246-670	42 in	Laminate	Specify	Specify	Specify	\$959.95
6-5004249-670	48W x 30D in	Laminate	Specify	Specify	Specify	\$932.95
6-5004247-670	60W x 30D in	Laminate	Specify	Specify	Specify	\$986.95
6-5004248-670	72W x 30D in	Laminate	Specify	Specify	Specify	\$1,012.95
6-5004250-670	60W x 36D in	Laminate	Specify	Specify	Specify	\$1,012.95
6-5004251-670	72W x 36D in	Laminate	Specify	Specify	Specify	\$1,039.95
<b>Markerboard with T-Mold</b>						
6-5004252-670	42 in	Markerboard	White	Specify	Specify	\$939.95
6-5004255-670	48W x 30D in	Markerboard	White	Specify	Specify	\$912.95
6-5004253-670	60W x 30D in	Markerboard	White	Specify	Specify	\$966.95
6-5004254-670	72W x 30D in	Markerboard	White	Specify	Specify	\$992.95
6-5004256-670	60W x 36D in	Markerboard	White	Specify	Specify	\$992.95
6-5004257-670	72W x 36D in	Markerboard	White	Specify	Specify	\$1,019.95
<b>Markerboard with LockEdge®</b>						
6-5004258-670	42 in	Markerboard	White	Specify	Specify	\$1,006.95
6-5004261-670	48W x 30D in	Markerboard	White	Specify	Specify	\$979.95
6-5004259-670	60W x 30D in	Markerboard	White	Specify	Specify	\$1,032.95
6-5004260-670	72W x 30D in	Markerboard	White	Specify	Specify	\$1,059.95
6-5004262-670	60W x 36D in	Markerboard	White	Specify	Specify	\$1,059.95
6-5004263-670	72W x 36D in	Markerboard	White	Specify	Specify	\$1,086.95
<b>Butcher Block</b>						
6-5004264-670	42 in	Butcher Block	-	-	Specify	\$1,226.95
6-5004267-670	48W x 30D in	Butcher Block	-	-	Specify	\$1,199.95
6-5004265-670	60W x 30D in	Butcher Block	-	-	Specify	\$1,252.95
6-5004266-670	72W x 30D in	Butcher Block	-	-	Specify	\$1,279.95
6-5004268-670	60W x 36D in	Butcher Block	-	-	Specify	\$1,279.95
6-5004269-670	72W x 36D in	Butcher Block	-	-	Specify	\$1,306.95

Item #	Product Dimensions	List Price
<b>Top Shelf for Smaller Frame (42 in and 48 in wide)</b>		
9-2051364-670	34 W x 18 D in	\$79.95
<b>Bottom Shelf for Smaller Frame (42 in and 48 in wide)</b>		
9-2051363-670	34 W x 22-1/2 D in	\$92.95
<b>Top Shelf for Larger Frame (60 in and 72 in wide)</b>		
9-2051210-670	52 W x 18 D in	\$119.95
<b>Bottom Shelf for Larger Frame (60 in and 72 in wide)</b>		
9-2051211-670	52 W x 22-1/2 D in	\$132.95

**PLEASE SPECIFY COLOR CHOICE**  
Please refer to page 60-61 for all color selections.



PRODUCT CERTIFIED FOR LOW CHEMICAL EMISSIONS: UL COM/IGG UL 2918



### Classroom Select® Makerspace Professional Project Table

An extension to the Advocate Series® desk, is now offered in a heavy-duty makerspace project table! Choose from our two table top sizes in 60" x 30" and 72" x 30". This table features a solid 2-1/2" 14-gauge square tube leg that adjusts in height from 28" to 42" in 1" increments allowing you to choose a sitting or standing worksurface. Both tables come with a titanium powder coat colored frame. Comes with 4 glides and 4 casters (2 locking and 2 non-locking). Vinyl T-Mold edge is available on 1-1/8" particleboard. Colored LockEdge® is a sprayed on polyurethane edge on a 1-1/8" MDF top, providing increased durability.



**NEW**

Item #	Product Dimensions	Top Type	Top Color	Edge Color	List Price
6-5009898-670	60 W x 30 D	Laminate	Specify	Specify	\$884.95
6-5009899-670	60 W x 30 D	Laminate	Specify	Specify	\$918.95
6-5009900-670	60 W x 30 D	Markerboard	-	Specify	\$931.95
6-5009901-670	60 W x 30 D	Markerboard	-	Specify	\$964.95
6-2106978-670	60 W x 30 D	Butcher Block	-	-	\$1,151.95
6-5009904-670	72 W x 30 D	Laminate	Specify	Specify	\$911.95
6-5009905-670	72 W x 30 D	Laminate	Specify	Specify	\$944.95
6-5009906-670	72 W x 30 D	Markerboard	-	Specify	\$958.95
6-5009907-670	72 W x 30 D	Markerboard	-	Specify	\$991.95
6-2106976-670	72 W x 30 D	Butcher Block	-	-	\$1,178.95



Shown with markerboard top option



### Classroom Select® STEAM Table

The Classroom Select® Mobile STEAM Table features four compartments, each with two adjustable shelves and locking doors. Table top is available in your choice of durable wood-grained laminate or markerboard. Table top grommet features three AC outlets, two USB ports, and an Ethernet jack. Heavy-duty 3" locking casters. Assembled.

Item #	Description	Product Dimensions	Frame Color	Top Color	Top Type	Number of Doors	Number of Stations	List Price
6-1603222-670	Laminate, 30 Inch Height	47-3/4 W x 47-3/4 D x 30 H in	Birch	Amber Maple	Laminate	4	4	\$1,666.95
6-2027838-670	Markerboard, 30 Inch Height	47-3/4 W x 47-3/4 D x 30 H in	Birch	White	Markerboard	4	4	\$1,767.95
6-1603221-670	Laminate, 25 Inch Height	47-3/4 W x 47-3/4 D x 25 H in	Birch	Amber Maple	Laminate	-	4	\$1,356.95
6-2027839-670	Markerboard, 25 Inch Height	47-3/4 W x 47-3/4 D x 25 H in	Birch	White	Markerboard	-	4	\$1,457.95

### Classroom Select® Vigor® Butcher Block Utility Table

Made of 1-1/2" finished solid wood butcher block. Sealed with a polyurethane coating, making this top a perfect addition to our most heavy-duty Vigor® Utility Table.



Top Shape	Product Dimensions	Leg Style	Butcherblock Top	
			Item #	List Price
Rectangle	24 x 48 in	Specify	6-5004645-670	\$932.95
Rectangle	24 x 60 in	Specify	6-5004639-670	\$946.95
Rectangle	30 x 48 in	Specify	6-5004644-670	\$946.95
Rectangle	30 x 60 in	Specify	6-5004640-670	\$959.95
Rectangle	30 x 72 in	Specify	6-5004641-670	\$972.95
Rectangle	36 x 60 in	Specify	6-5004642-670	\$972.95
Square	42 in	Specify	6-5004643-670	\$959.95

CLASSROOM  
SELECT



Refer to pages 60-61 for color options.



NEW



CPU Holder



NEW

**Classroom Select® - Advocate Series® E-Sports Table**

The Classroom Select® Advocate Series® Cable Management Computer Table, now available for your E-Sports desking needs, allows you to fully organize and secure any classroom computer cables. Choose from 3 top size options for your computer technology needs. Tops have 2 scalloped cut outs for easy flip-top viewing of the compartment trough. The legs are made of a durable 14-gauge, 1-inch square tube steel that adjust from 24" to 34". Computer table comes standard with nylon glides or create your mobile computer table by ordering a set of 4 locking casters separately. Frame features an integrated backpack hook on both sides. Vinyl T-Mold edge is available on 1-1/8" particleboard.

Item #	Description	Product Dimensions	Top Color	Edge Color	List Price
<b>Laminate Top</b>					
6-5009528-670	E-Sports Cable Management	48 W x 36 D	Specify	Specify	\$679.95
6-5009529-670	E-Sports Cable Management	60 W x 36 D	Specify	Specify	\$719.95
6-5009530-670	E-Sports Cable Management	72 W x 36 D	Specify	Specify	\$746.95
<b>Markerboard Top</b>					
6-5009531-670	E-Sports Cable Management	48 W x 36 D	-	Specify	\$726.95
6-5009532-670	E-Sports Cable Management	60 W x 36 D	-	Specify	\$766.95
6-5009533-670	E-Sports Cable Management	72 W x 36 D	-	Specify	\$792.95

Item #	Description	Product Dimensions	Maximum Height	List Price
9-2104229-670	CPU Holder	9-3/4W x 18H in	18 in	\$195.95

**Classroom Select® Y-Leg Computer Table**

Height-adjustable tables can be set from 25-1/2" to 33-1/2" and are available in three widths for unsurpassed versatility. Top is a hefty 1-1/8" thick scratch-resistant HPL with grommets. Black powdercoated steel frame includes glides and 3" casters. Supporting stretcher bar provides superior structural strength and durability, and includes a steel cable management tray that provides additional stabilization.

Item #	Product Dimensions	Top Color	Edge Color	List Price
<b>T-Mold Edge</b>				
6-5009522-670	36 W x 30 D	Specify	Specify	\$599.95
6-5009523-670	60 W x 30 D	Specify	Specify	\$652.95
6-5009524-670	72 W x 30 D	Specify	Specify	\$679.95
<b>LockEdge</b>				
6-5009525-670	36 W x 30 D	Specify	Specify	\$639.95
6-5009526-670	60 W x 30 D	Specify	Specify	\$692.95
6-5009527-670	72 W x 30 D	Specify	Specify	\$719.95



**Classroom Select® Flipper Computer Table**

The Classroom Select® Flipper Computer Table features a heavy-duty, flip-top mechanism base that allows for easy maintenance and classroom cleaning. The design of the legs allows the tables to nest together to save space during storage. Legs are 2" diameter, 18-gauge tubular steel with a black powdercoat finish. The base features a 16" modesty panel with wire management tray and heavy duty 3" twin wheel polyurethane locking casters.

Item #	Description	Product Dimensions	Top Color	Frame Color	Edge Color	List Price
<b>Laminate Top</b>						
6-1400986-670	T-Mold Edge Flip-Top Table	60 W x 24 D in	Specify	Black	Specify	\$566.95
6-5003809-670	LockEdge Flip-Top Table	60 W x 24 D in	Specify	Black	Specify	\$632.95
6-1400985-670	T-Mold Edge Flip-Top Table	72 W x 24 D in	Specify	Black	Specify	\$599.95
6-5003808-670	LockEdge Flip-Top Table	72 W x 24 D in	Specify	Black	Specify	\$666.95
<b>Markerboard Top</b>						
6-5003807-670	T-Mold Edge Flip-Top Table	60 W x 24 D in	White	Black	Specify	\$612.95
6-5004855-670	LockEdge Flip Top Table	60 W x 24 D in	White	Black	Specify	\$679.95
6-5003810-670	T-Mold Edge Flip-Top Table	72 W x 24 D in	White	Black	Specify	\$646.95
6-5004856-670	LockEdge Flip Top Table	72 W x 24 D in	White	Black	Specify	\$712.95





PLEASE SPECIFY COLOR CHOICE  
Please refer to page 60-61 for all color selections.



PRODUCT CERTIFIED FOR LOW CHEMICAL EMISSIONS: UL.COM/CGG UL 2818



### Classroom Select® Height Adjustable Tilt-N-Nest® Computer Table

The Classroom Select® Height Adjustable Tilt-N-Nest® Computer Table has a sleek T-leg design and offers flexibility for every classroom. Tables adjust from 29" to 37", on 1" increments, which easily accommodates a range of ages. Tilt the tops to use as an easel and add markerboard to create a presentation space for students or instruction for teachers. Tops adjust with a simple one-handed lever mechanism providing convenient transport and nesting for compact storage. Mobility is a breeze with standard, dual-wheel, non-marring locking casters. The frame is made of strong 14-gauge steel legs that attach to 11-gauge feet, providing ultimate stability. Vinyl T-Mold edge is available on 1-1/8" particleboard. LockEdge® is a spray on polyurethane edge available on a 1-1/8" MDF top.



Item #	Product Dimensions	Top Color	Frame Color	Edge Color	List Price
<b>Laminate with T-Mold</b>					
6-5004184-670	60 W x 24 D in	Specify	Titanium	Specify	\$552.95
6-5004183-670	60 W x 30 D in	Specify	Titanium	Specify	\$566.95
6-5004186-670	72 W x 24 D in	Specify	Titanium	Specify	\$566.95
6-5004185-670	72 W x 30 D	Specify	Titanium	Specify	\$579.95
<b>Laminate with LockEdge®</b>					
6-5004188-670	60 W x 24 D in	Specify	Titanium	Specify	\$652.95
6-5004187-670	60 W x 30 D in	Specify	Titanium	Specify	\$666.95
6-5004190-670	72 W x 24 D in	Specify	Titanium	Specify	\$666.95
6-5004189-670	72 W x 30 D in	Specify	Titanium	Specify	\$679.95

Item #	Product Dimensions	Top Color	Frame Color	Edge Color	List Price
<b>Markerboard with T-Mold</b>					
6-5004192-670	60 W x 24 D in	Markerboard	Titanium	Specify	\$599.95
6-5004191-670	60 W x 30 D in	Markerboard	Titanium	Specify	\$612.95
6-5004194-670	72 W x 24 D in	Markerboard	Titanium	Specify	\$612.95
6-5004193-670	72 W x 30 D in	Markerboard	Titanium	Specify	\$626.95
<b>Markerboard with LockEdge®</b>					
6-5004671-670	60 W x 24 D in	Markerboard	Titanium	Specify	\$699.95
6-5004670-670	60 W x 30 D in	Markerboard	Titanium	Specify	\$712.95
6-5004673-670	72 W x 24 D in	Markerboard	Titanium	Specify	\$712.95
6-5004672-670	72 W x 30 D in	Markerboard	Titanium	Specify	\$726.95



### Classroom Select® Advocate Series® Four Leg Cable Management Computer Table

The Advocate Series® Cable Management Computer Table allows you to fully organize and secure any classroom computer cables. Choose from 6 top sizes for your computer technology needs. Tops have 2 scalloped cut outs for easy flip-top viewing of the compartment trough. The legs are made of a durable 14-gauge, 1" square tube steel that adjust from 24" to 34" offered with a standard nylon glide. Create your mobile computer table by ordering a set of 4 locking casters separately. Frame features an integrated backpack hook on both sides. Vinyl T-Mold edge is available on 1-1/8" particleboard. Not available in LockEdge®.

Item #	Product Dimensions	Top Color	Frame Color	Edge Color	List Price
<b>Laminate with T-Mold</b>					
6-5004196-670	48 W x 24 D in	Specify	Titanium	Specify	\$683.95
6-5004197-670	60 W x 24 D in	Specify	Titanium	Specify	\$716.95
6-5004729-670	60 W x 30 D in	Specify	Titanium	Specify	\$750.95
6-5004195-670	72 W x 24 D in	Specify	Titanium	Specify	\$750.95
6-5004728-670	72 W x 30 D in	Specify	Titanium	Specify	\$783.95

Item #	Product Dimensions	Top Color	Frame Color	Edge Color	List Price
<b>Markerboard with T-Mold</b>					
6-5004202-670	48 W x 24 D in	White	Titanium	Specify	\$730.95
6-5004203-670	60 W x 24 D in	White	Titanium	Specify	\$763.95
6-5004731-670	60 W x 30 D in	White	Titanium	Specify	\$796.95
6-5004201-670	72 W x 24 D in	White	Titanium	Specify	\$796.95
6-5004730-670	72 W x 30 D in	White	Titanium	Specify	\$830.95

Set of 4 Casters  
9-2040212-670 \$30.95

### Classroom Select® Tilt-N-Nest® EZ-Twist Desk

The Classroom Select® Tilt-N-Nest® EZ-Twist Desk offers flexibility for every classroom. Tilt the tops by activating the side knob for an easy and simple transition from a working surface to a nesting position for compact storage. Mobility is a breeze with standard, dual-wheel, non-marring locking casters. Vinyl T-Mold edge is available on 1-1/8" particleboard. LockEdge® is a spray on polyurethane edge available on a 1-1/8" MDF top.

Item #	Product Dimensions	Edge Color	Top Type	Top Size	Edge Type	Frame Color	Top Color	List Price
6-5008654-670	28 W x 20 D x 29 H in	Specify	Laminate	28 W x 20 D	T-Mold	Black	Specify	\$452.95
6-5008661-670	28 W x 20 D x 29 H in	Specify	Laminate	28 W x 20 D	LockEdge	Specify	Specify	\$519.95
6-5008694-670	48 W x 24 D x 29 H in	Specify	Laminate	48 W x 24 D	T-Mold	Specify	Specify	\$519.95
6-5008666-670	48 W x 24 D x 29 H in	Specify	Laminate	48 W x 24 D	LockEdge	Specify	Specify	\$586.95
6-5008658-670	28 W x 20 D x 29 H in	Specify	Markerboard	28 W x 20 D	T-Mold	Specify	White	\$466.95
6-5008673-670	28 W x 20 D x 29 H in	Specify	Markerboard	28 W x 20 D	LockEdge	Specify	White	\$532.95
6-5008660-670	48 W x 24 D x 29 H in	Specify	Markerboard	48 W x 24 D	T-Mold	Specify	White	\$532.95
6-5008687-670	48 W x 24 D x 29 H in	Specify	Markerboard	48 W x 24 D	LockEdge	Specify	White	\$599.95

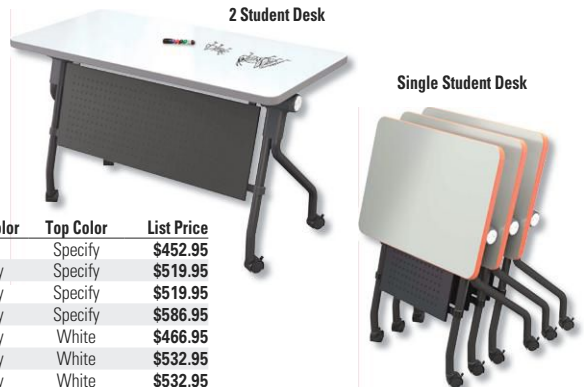



PRODUCT CERTIFIED FOR LOW CHEMICAL EMISSIONS: ULL-COAWGG-UL 2818



Refer to pages 60 - 61 for color options.

**Classroom Select® Pedestal Leg Activity Table**

In today's environment collaboration and versatility is a must! Our Pedestal Leg Activity Table provides both. Work in an individual or small group setting and even combine tables to create a larger collaborative environment. With sturdy 22" to 30" adjustable height pedestal legs, made with all rectangular 16-gauge steel tubing, these tables are designed for dependability. Choose your top and choose your edge to create a table that works for your unique environment. Don't forget to add the book box! The black metal book box measures approximately 15" W x 11" D x 4-1/2" H, and is sold separately.

- **Laminate Top** – High pressure laminate tabletops have a 1-1/8" solid core with a phenolic resin backer, choose a top color. Available in Rectangle or Trapezoid top shapes.
- **Markerboard Top** – High pressure markerboard laminate tabletops have a 1-1/8" solid core with a phenolic resin backer. Available in white markerboard, rectangle or trapezoid top shapes.
- **T-Mold Edge** – Smooth durable edge, choose an edge color.
- **LockEdge®** – Textured durable edge, available in 5 colors.
- **Leg** – Choose a glide or 2-1/2" caster leg. Caster leg adjustable height is 24-3/4" to 32-3/4" with caster.



Item #	Top Shape	Product Dimensions	Top Color	Edge Color	List Price
<b>Laminate Top, T-Mold Edge</b>					
6-1496732-670	Rectangle	36 W x 24 D in	Specify	Specify	\$286.95
6-1496712-670	Rectangle	48 W x 24 D in	Specify	Specify	\$299.95
6-1496713-670	Rectangle	60 W x 24 D in	Specify	Specify	\$312.95
6-1496714-670	Rectangle	72 W x 24 D in	Specify	Specify	\$339.95
6-1496733-670	Rectangle	48 W x 30 D in	Specify	Specify	\$312.95
6-1496715-670	Rectangle	60 W x 30 D in	Specify	Specify	\$339.95
6-1496716-670	Rectangle	72 W x 30 D in	Specify	Specify	\$366.95
6-1496717-670	Rectangle	60 W x 36 D in	Specify	Specify	\$366.95
6-1496718-670	Rectangle	72 W x 36 D in	Specify	Specify	\$392.95
6-1496720-670	Trapezoid	60 W x 30 D in	Specify	Specify	\$339.95
<b>Laminate Top, T-Mold Edge, Leg with Casters</b>					
6-1601578-670	Rectangle	36 W x 24 D in	Specify	Specify	\$319.95
6-1601579-670	Rectangle	48 W x 24 D in	Specify	Specify	\$332.95
6-1601580-670	Rectangle	60 W x 24 D in	Specify	Specify	\$346.95
6-1601581-670	Rectangle	72 W x 24 D in	Specify	Specify	\$372.95
6-1601582-670	Rectangle	48 W x 30 D in	Specify	Specify	\$346.95
6-1601583-670	Rectangle	60 W x 30 D in	Specify	Specify	\$372.95
6-1601584-670	Rectangle	72 W x 30 D in	Specify	Specify	\$399.95
6-1601587-670	Trapezoid	60 W x 30 D in	Specify	Specify	\$372.95
<b>Markerboard Top, T-Mold Edge</b>					
6-1496788-670	Rectangle	36 W x 24 D in	White	Specify	\$332.95
6-1496789-670	Rectangle	48 W x 24 D in	White	Specify	\$346.95
6-1496790-670	Rectangle	60 W x 24 D in	White	Specify	\$359.95
6-1496791-670	Rectangle	72 W x 24 D in	White	Specify	\$386.95
6-1496792-670	Rectangle	48 W x 30 D in	White	Specify	\$359.95
6-1496793-670	Rectangle	60 W x 30 D in	White	Specify	\$386.95
6-1496794-670	Rectangle	72 W x 30 D in	White	Specify	\$412.95
6-1496795-670	Rectangle	60 W x 36 D in	White	Specify	\$412.95
6-1496796-670	Rectangle	72 W x 36 D in	White	Specify	\$439.95
6-1497103-670	Trapezoid	60 W x 30 D in	White	Specify	\$386.95
<b>Markerboard Top, T-Mold Edge with Casters</b>					
6-1601608-670	Rectangle	36 W x 24 D in	White	Specify	\$366.95
6-1601609-670	Rectangle	48 W x 24 D in	White	Specify	\$379.95
6-1601610-670	Rectangle	60 W x 24 D in	White	Specify	\$392.95
6-1601611-670	Rectangle	72 W x 24 D in	White	Specify	\$419.95
6-1601612-670	Rectangle	48 W x 30 D in	White	Specify	\$392.95
6-1601613-670	Rectangle	60 W x 30 D in	White	Specify	\$419.95
6-1601614-670	Rectangle	72 W x 30 D in	White	Specify	\$446.95
6-1601617-670	Trapezoid	60 W x 30 D in	White	Specify	\$419.95

Item #	Top Shape	Product Dimensions	Top Color	Edge Color	List Price
<b>Laminate Top, LockEdge®</b>					
6-1496721-670	Rectangle	36 W x 24 D in	Specify	Specify	\$352.95
6-1496722-670	Rectangle	48 W x 24 D in	Specify	Specify	\$366.95
6-1496723-670	Rectangle	60 W x 24 D in	Specify	Specify	\$379.95
6-1496724-670	Rectangle	72 W x 24 D in	Specify	Specify	\$406.95
6-1496725-670	Rectangle	48 W x 30 D in	Specify	Specify	\$379.95
6-1496726-670	Rectangle	60 W x 30 D in	Specify	Specify	\$406.95
6-1496727-670	Rectangle	72 W x 30 D in	Specify	Specify	\$432.95
6-1496728-670	Rectangle	60 W x 36 D in	Specify	Specify	\$432.95
6-1496729-670	Rectangle	72 W x 36 D in	Specify	Specify	\$459.95
6-1496731-670	Trapezoid	60 W x 30 D in	Specify	Specify	\$406.95
<b>Laminate Top, LockEdge®, Leg with Casters</b>					
6-1601588-670	Rectangle	36 W x 24 D in	Specify	Specify	\$386.95
6-1601589-670	Rectangle	48 W x 24 D in	Specify	Specify	\$399.95
6-1601590-670	Rectangle	60 W x 24 D in	Specify	Specify	\$412.95
6-1601591-670	Rectangle	72 W x 24 D in	Specify	Specify	\$439.95
6-1601592-670	Rectangle	48 W x 30 D in	Specify	Specify	\$412.95
6-1601593-670	Rectangle	60 W x 30 D in	Specify	Specify	\$439.95
6-1601594-670	Rectangle	72 W x 30 D in	Specify	Specify	\$466.95
6-1601597-670	Trapezoid	60 W x 30 D in	Specify	Specify	\$439.95
<b>Markerboard Top, LockEdge®</b>					
6-5004793-670	Rectangle	36 W x 24 D in	White	Specify	\$399.95
6-5004794-670	Rectangle	48 W x 24 D in	White	Specify	\$412.95
6-5004795-670	Rectangle	60 W x 24 D in	White	Specify	\$426.95
6-5004796-670	Rectangle	72 W x 24 D in	White	Specify	\$452.95
6-5004797-670	Rectangle	48 W x 30 D in	White	Specify	\$426.95
6-5004798-670	Rectangle	60 W x 30 D in	White	Specify	\$452.95
6-5004799-670	Rectangle	72 W x 30 D in	White	Specify	\$479.95
6-5004800-670	Rectangle	60 W x 36 D in	White	Specify	\$479.95
6-5004801-670	Rectangle	72 W x 36 D in	White	Specify	\$506.95
6-5004802-670	Trapezoid	60 W x 30 D in	White	Specify	\$452.95
<b>Markerboard Top, LockEdge® with Casters</b>					
6-1601598-670	Rectangle	36 W x 24 D in	White	Specify	\$432.95
6-1601599-670	Rectangle	48 W x 24 D in	White	Specify	\$446.95
6-1601600-670	Rectangle	60 W x 24 D in	White	Specify	\$459.95
6-1601601-670	Rectangle	72 W x 24 D in	White	Specify	\$486.95
6-1601602-670	Rectangle	48 W x 30 D in	White	Specify	\$459.95
6-1601603-670	Rectangle	60 W x 30 D in	White	Black	\$486.95
6-1601604-670	Rectangle	72 W x 30 D in	White	Specify	\$512.95
6-1601607-670	Trapezoid	60 W x 30 D in	White	Black	\$486.95

Item #	Description	List Price
9-1547618-670	Activity Table Book Box	\$27.95
9-5002704-670	Technology Basket	\$31.95
<b>Additional Power Options</b>		
6-5004132-670	Clamp Mount	\$366.95
6-5004726-670	Under Table Mount	\$366.95

# CLASSROOM SELECT® TABLE COMPARISON CHART

Use this chart to compare our top-selling tables to find the right product for your needs.



**CONTRUCT-HT®  
PROJECT CENTERS**  
P. 76



**VIGOR® TABLE**  
P. 74-75



**ADVOCATE SERIES®  
CABLE MANAGEMENT  
COMPUTER TABLE**  
P. 79



**TILT N NEST®  
COMPUTER TABLE**  
P. 79



**FLIPPER  
COMPUTER TABLE**  
P. 78



**ACTIVITY TABLE**  
P. 62-73

<b>Top Shapes</b>	2 shapes	7 shapes	1 shape	1 shape	1 shape	32 shapes
<b>Top Type</b>	Markerboard, Laminate, Butcher Block	Markerboard, Laminate, Butcher Block	Markerboard, Laminate	Markerboard, Laminate	Markerboard, Laminate	Markerboard, Laminate
<b>Top Colors</b>	32 Laminate Colors	32 Laminate Colors	32 Laminate Colors	32 Laminate Colors	32 Laminate Colors	32 Laminate Colors
<b>Edge Types</b>	T-Mold, LockEdge®	T-Mold, LockEdge®	T-Mold	T-Mold, LockEdge®	T-Mold, LockEdge®	T-Mold, LockEdge®
<b>Edge Colors</b>	23 T-Mold, 5 LockEdge®	23 T-Mold, 5 LockEdge®	23 T-Mold	23 T-Mold, 5 LockEdge®	23 T-Mold, 5 LockEdge®	23 T-Mold, 5 LockEdge®
<b>Leg Style/ Frame Type</b>	A-Frame	Unitized Frame	C Frame	Flip Frame Nesting Frame	Flip Frame Nesting Frame	Standard Leg, Apollo Leg, NeoClass® Elliptical Leg
<b>Leg/Frame Color</b>	Titanium	Black	Titanium	Titanium	Black	Standard/ Apollo Leg - 7 colors NeoClass® Leg - 11 colors
<b>Height Options</b>	29-40" Height Adjustable	29-42" Height Adjustable	24-34" Height Adjustable	29-37" Height Adjustable	30" Fixed Height	Standard Leg - 15-25", 22-30" Apollo Leg - 11-17", 15-25", 22-30" NeoClass® Elliptical Leg - 15-25", 22-30", 30-43"
<b>Glides Casters</b>	Glides	Nylon	Nylon			Nylon
	Casters	Casters Included	Sold Separately	Sold Separately	Casters Included	Casters Included
<b>Cable Management</b>			2 Scalloped Cutouts			

Contact your School Specialty rep to discuss custom options.

# LUXOR

## Stand Up Adjustable Tables

With the Luxor Innovative Sit to Stand adjustable crank desks, it's easy to achieve long lasting health benefits like burning more daily calories, boosting productivity, improving posture and reducing risk of heart problems. The crank allows for effortless adjustment from sitting to standing. Perfect for desktop, laptop or tablet computing. Mobile and adjustable to meet your everyday needs. It has a durable steel frame with powder coat paint finish. Desk is easy to maneuver with four 3" furniture casters, two with locking brakes. Includes all hardware and tools required for assembly.



Item #	Product Dimensions	List Price
6-1559581-670	48 x 29-1/2 x 29-45-1/4 in	\$1,092.95
6-1559548-670	39-3/8 x 23-5/8 x 30-45-1/4 in	\$1,177.95
6-1560975-670	59 x 29-1/2 x 29-1/2-45-1/4 in	\$1,207.95



# LUXOR

## Luxor Adjustable Flip-Top Table with Crank Handle

This flip-top table is a multipurpose sit/stand desk that's perfect for schools, training rooms, or general office use. The convenient crank handle adjusts the table height from 30" to 42-1/4" to accommodate a range of seated or standing users, while 3" locking casters allow easy mobility. Adding to its versatility, each table can be neatly folded for space-saving storage using two pull-handles that flip the table into a nesting position. Choose the 60" or 72" mobile flipper table to create a professional and ergonomic work space.

- Grommet holes route, network, and organize cables
- Easy set-up and teardown with release latches under table
- Multiple tables nest together for simple storage

Item #	Description	Product Dimensions	Top Color	Frame Color	List Price
6-1581415-670	72" Adjustable Flip-Top Table	71 Wx23-1/2 Dx30 - 45-1/4 H in	Gray	Gray	\$1,357.95
6-1581414-670	60" Adjustable Flip-Top Table	59 Wx23-1/2 Dx30 - 45-1/4 H in	Gray	Gray	\$1,476.95



## National Public Seating® Plastic Flip-n-Store Tables

A Flipper table with a blow-molded high-density polyethylene top! Lightweight (only 48 lbs.) Use for training or conference room or seminary setup. Includes wire management grommets and a modesty panel. Can hold up to 700 lbs. Tables nest together for space-saving storage. Minimal assembly required. Comes in Speckled Gray smooth top with Gray powdercoat legs. Easily portable with four 2" casters (two locking).

Item #	Product Dimensions	List Price
6-1453091-670	60 W x 24 D x 29-1/2 H in	\$608.95
6-1541262-670	72 W x 24 D x 29-1/2 H in	\$698.95





# art room



## Diversified Woodcrafts Laminate Colors



Art Bench



projects by design™

## Diversified Spaces™ Art and Planning Table

Designed to be used in most any environment from art and general planning to sewing and model construction. The base is constructed of two tapered solid maple pedestal style panel legs and two solid maple truss bars. The unique way the top is attached prevents the table from racking or rocking. The table is finished with an earth-friendly UV finish. Choose from a 1-3/4" solid maple top or 1-1/4" plastic laminate with a 3mm PVC edging in your choice of almond or birch color.

Item #	Description	Product Dimensions	Top Type	List Price
6-1285113-670	Without Compartments	60 W x 42 D x 26 H in	Almond Laminate	\$1,734.95
6-818305-670	Without Compartment	60 W x 42 D x 30 H in	Specify	\$1,709.95
6-815411-670	With Book Compartments	60 W x 42 D x 30 H in	Specify	\$1,771.95
6-818291-670	Without Compartment	60 W x 42 D x 30 H in	Solid Maple	\$2,366.95
6-815454-670	With Book Compartments	60 W x 42 D x 30 H in	Solid Maple	\$2,458.95
<b>Art Bench</b>				
6-406961-670	Art Bench	17 W x 12 D x 17 H in	Solid Maple	\$384.95

## Diversified Spaces™ Extra Large Pedestal Table

A larger model of the plain pedestal table. With a 72" W x 48" D top size, and 36" leg height this table is designed to be large enough for multiple users to work on projects. The base is constructed of two tapered solid maple pedestal style panel legs and two solid maple truss bars.

Item #	Top Type	List Price
6-1400066-670	Almond Laminate	\$1,893.95
6-1400067-670	Natural Birch Laminate	\$1,893.95
6-1400065-670	Hard Maple	\$3,352.95



## Debcor Ceramic Work Tables

Ideal for ceramic workshops, studios and labs, these multipurpose work tables have Formica tops to resist liquids and clean up easily. Available in a variety of sizes and heights. Available in the color Gray.

Item #	Description	Product Dimensions	Top Type	List Price
6-424060-670	Ceramic Works Table	48 W x 24 D x 31 - 35 H in	Laminated Particleboard	\$1,255.95
6-672337-670	Ceramic Works Table	60 W x 30 D x 31 - 35 H in	Laminated Particleboard	\$1,442.95
6-656509-670	Ceramic Works Table	72 W x 30 D x 31 - 35 H in	Laminated Particleboard	\$1,605.95



**Diversified Spaces Tall Storage Cabinet**

Constructed of solid hardwood, solid maple and maple veneers, and highlighted by an earth-friendly UV finish. Upper section consists of four adjustable 1" shelves and one fixed bottom shelf. The locking doors provide secure storage. The lower section consists of four locking drawers (22-3/4 W x 19-3/4 D x 8-1/4 H in) that are fully dovetailed.

Item #	Product Dimensions	Number of Drawers	List Price
6-1397225-670	48 W x 22 D x 84 H in	4	\$3,353.95

**Diversified Spaces General Storage Cabinet**

Solid hardwood, solid maple and maple veneers, highlighted by an earth-friendly UV finish. Available with hinged maple doors. Each cabinet comes with a 3-point locking system. 48" wide maple door units have 1" shelves. All units include two fixed and four adjustable shelves. Limited lifetime warranty.

Item #	Product Dimensions	List Price
6-1400058-670	48 W x 22 D x 84 H in	\$2,400.95
6-1303047-670	60 W x 22 D x 84 H in	\$3,031.95



**Diversified Spaces Tote Tray Cabinet**

This sensible storage case holds 48 tote trays (14-1/2 W x 19 D x 3-1/2 H in). A great place for students to store their art, sewing or individual projects. Maple doors with 3-point locking handles. Unit includes 48 trays.

Item #	Product Dimensions	Number of Trays	List Price
6-1400068-670	48 W x 22 D x 84 H in	48	\$5,622.95



**brent®**  
**brent® Ware Cart EX**

Designed for stability, convenience and versatility. Stack bats, ware, tools, etc. according to your needs. Constructed of heavy duty 1" steel pipe with welded on shelf supports, with 4 rubber tires on swivel casters. Includes twelve 12" x 32" x 1/2" shelves constructed on 1/2" thick exterior grade plywood to support heavy loads. Shipped knocked down, minimal assembly needed. 9 shelf supports. Also includes plastic cover to slow dry time of wet work and minimize dust.



Item #	Dimensions	List Price
6-232761-670	35 W x 24 D x 72-3/4 H in	\$1,579.95



**Diversified Spaces Portfolio Cabinet**

Solid maple, hardwood and maple veneers, finished with a clear chemical resistant UV finish. Unit can hold up to 39 portfolios for 24" W x 30" L papers. Unit has dividers that are removable so you can add thicker portfolios as well. The dividers are made of zinc.

Item #	Product Dimensions	List Price
6-1400052-670	36 W x 30 D x 84 H in	\$2,516.95



**brent® SmartCart™**

A smart "art cart" on wheels, this sturdy cart has a solid top shelf and two steel mesh shelves for storing ceramic supplies while working. Includes a retractable shelf that slides right or left for additional work or storage area. The top shelf has four pre-drilled holes to accommodate the brent® Mini Slab Roller. The four heavy-duty swivel/locking casters make the SmartCart™ easily maneuverable so it can be stored away in closets. Includes one year warranty.

Item #	Dimensions	List Price
6-1442910-670	27 W x 24-1/2 D x 34 H in	\$1,466.95

**brent® Ware Cart EX**

Designed for stability, convenience and versatility. Stack bats, ware, tools, etc. according to your needs. Constructed of heavy duty 1" steel pipe with welded on shelf supports, with 4 rubber tires on swivel casters. Includes twelve 12" x 32" x 1/2" shelves constructed on 1/2" thick exterior grade plywood to support heavy loads. Shipped knocked down, minimal assembly needed. 9 shelf supports. Also includes plastic cover to slow dry time of wet work and minimize dust.



Item #	Dimensions	List Price
6-232761-670	35 W x 24 D x 72-3/4 H in	\$1,579.95



**Debcor All Steel Portable Clay Storage Cart**

Portable, holds 140 lbs. of clay. Keeps clay workable and moist. Heavy-duty all-steel construction, with removable plastic liner and lid. Hinged lid for easy access. 4" ball-bearing swivel wheels for easy mobility. Outside dimensions: 17-1/2" W x 13-1/2" D x 28-1/2" H. Dark brown.



Item #	Description	List Price
6-423145-670	Portable Clay Storage Cart	\$1,041.95



**Debcor Wedging Board with Steel Stand**

Heavy-duty steel table for wedging or kneading clay before forming. Stand is 19-1/2" x 20-3/4" and adjusts from 30" to 36" in height. Includes wedging board which bolts to top of stand. (Plaster not furnished). Dark brown in color.



Item #	Description	List Price
6-401511-670	Wedging Board with Stand	\$1,598.95



**Debcor Damp-Proof Cabinet**

Designed to maintain your clay projects in moist workable condition. This model features rubber gasketed doors of double-wall construction. Interior sides and backs are lined with aluminum panels attached to the outer steel structure. Cabinet has 4 angle shelves, each shelf has one 18" x 36" x 1 1/8" highly absorbent foam bat. Ship wt. 275 lbs.

Item #	Description	Dimensions	List Price
A 6-405172-670	Large Damp-Proof Cabinet	36 W x 18 D x 84 H in	\$5,983.95

**Debcor Drying Cabinet**

Offers proper storage of your clay projects during the drying period. Each unit is furnished with 4 large angle frame shelves covered with 1/8" tempered pegboard to increase movement of air and improve the drying process.

Item #	Description	Dimensions	List Price
B 6-423146-670	Large Drying Cabinet	36 W x 18 D x 84 H in	\$4,460.95



A



B



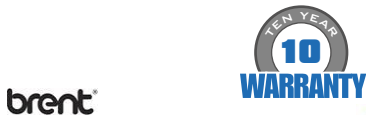

**brent®**

**brent® B Pottery Wheel**

The 1/2-hp, 5-amp motor handles up to 150 lbs. of clay continuously. Solid all-steel table with durable poly cover features a 14" cast aluminum wheel head, forward/reverse switch, and automatic belt tensioning. Receive a \$100 manufacturer's rebate for AMACO® glazes with purchase.



Item #	Description	Dimensions	Ship Weight	List Price
6-1127442-670	Model B Wheel	21 W x 28 D x 21-1/2 H in	130 lbs	\$2,978.95



**brent®**

**brent® C Pottery Wheel**

The 3/4-hp, 7-amp motor handles up to 225 lbs. of clay continuously. Solid all-steel table with durable poly cover features a 14" cast aluminum wheel head, forward/reverse switch, and automatic belt tensioning. Receive a \$100 manufacturer's rebate for AMACO® glazes with purchase.



Item #	Description	Dimensions	Ship Weight	List Price
6-1127441-670	Model C Wheel	21 W x 28 D x 21-1/2 H in	130 lbs	\$3,078.95



**Shimpo® VL-Whisper Potter's Wheel**

Brushless 1/2-hp DC motor with direct-drive (no belts or pulleys) system provides plenty of power for centering up to 100 lbs. of clay. Broad speed range of 0-250 rpm is controlled by foot pedal. Reversible for left and right-handed users. Includes 14" alloy wheelhead drilled for bats and two-piece splash pan. New space-saving storage option frees up valuable space in your classroom or studio.

Item #	Description	Dimensions	Ship Weight	List Price
6-406221-670	Brushless Pottery Wheel	14 in	135 lbs	\$2,736.95



**Artista™ Potter's Wheel**

This Artista™ Pottery Wheel is completely portable for tabletop use. Weighing only 26 pounds it can be cleaned, transported, and stored easily. Features an 11-inch wheel head and a height of 3-5/8 inches above tabletop. Offers a 1/2-horsepower industrial motor that runs smoothly with little noise. This wheel is stable on any flat surface, ideal for standing up, throwing, or for physically-challenged access. Variable speed hand control (0-220 RPM). Sturdy, high-impact plastic and steel-frame construction. It has a convenient space for two 2-1/2 quart buckets, included (for tools and water). Makes an ideal trimming station.



Item #	Description	Dimensions	Ship Weight	List Price
6-1363304-670	Pottery Wheel	11 in	40 lbs	\$932.95
6-1402106-670	Pottery Wheel - Left Hand	11 in	40 lbs	\$932.95



**Bailey Mini-Might Slab Rollers**

The Mini-Might slab rollers are small, portable, and ideal for classroom use. Durable, table top models don't require permanent installation or take up a lot of space. No need to clamp them down, just place on a table and the rubber feet will hold unit in place while you effortlessly roll out perfect slabs. Includes four shims and canvas. Slab thickness is variable from 1/8" to 3/4" in 1/8" intervals. The 16" Mini-Might rolls out 16" W x 18" L slabs. The 22" Mini-Might rolls out 22" W x 24" L slabs. Free-standing 22" Mini-Might floor unit includes leg set assembly.

Item #	Description	Dimensions	Ship Weight	List Price
6-408095-670	16-in Table Top Slab Roller	24 W x 21 D x 5 H in	44 lbs	\$941.95
6-408096-670	22-in Table Top Slab Roller	48 W x 28 D x 5 H in	87 lbs	\$1,240.95
6-2017136-670	22 in Slab Roller w/Leg Set	48 W x 24 L x 36 H in	110 lbs	\$1,809.95



**brent®**

**brent® SR Slab Rollers**

brent® SR slab rollers feature heavy gauge steel construction, a durable cable system, circular handles, and removable shims to adjust thickness. SR-14 model rolls slabs 14" W x 36" L, up to 1-3/4" thick. SR-20 model rolls slabs 20" W x 52" L, up to 1-1/2" thick.



Item #	Description	Dimensions	Ship Weight	List Price
6-1595141-670	Model SR-14 Slab Roller	52 W x 27 D x 40 H in	245 lbs	\$4,796.95
6-401860-670	Model SR-20 Slab Roller	76 W x 34 D x 40 H in	487 lbs	\$5,609.95





**SKUTT**

KMT Controller



**Why a Skutt?**

- Training DVD covers everything you need to know
- Spring assisted lid lifter is safe and easy to use
- U. L listing is the most trusted name in safety testing
- Two year warranty that includes parts and labor
- Web and phone technical support
- Sectional design fits through any doorway
- Balanced elements ensure even heating
- Easy to use KilnMaster or KilnMaster Touchscreen automatic controllers
- Pre-heat feature prevents cracking
- Delay firing feature adjusts the firing to your schedule
- Coated lids prevent brick dust falling into your glazed pieces
- Ramp and hold programming allows you to fuse glass
- Built-in diagnostics allows over the phone technical help

Model #	Phase	Volts	Amps	Cone	Firing Temp (°F)	Inside Dimensions	Ship Weight	KilnMaster® (KM) Controller		KilnMaster® Touchscreen (KMT) Controller	
								Item #	List Price	Item #	List Price
1027	1	208	48	6	2250	23-3/8 W x 27 D in	290 lbs	6-220164-670	\$6,371.95	6-2027246-670	\$7,362.95
1027	1	240	48	10	2350	23-3/8 W x 27 D in	290 lbs	6-220167-670	\$6,371.95	6-2027247-670	\$7,362.95
1027	3	208	31.7	10	2350	23-3/8 W x 27 D in	290 lbs	6-424503-670	\$6,762.95	6-2027248-670	\$7,525.95
1027	3	240	29.3	10	2350	23-3/8 W x 27 D in	290 lbs	6-424504-670	\$6,762.95	6-2027249-670	\$7,525.95
1027-3	1	208	48	10	2350	22-3/8 W x 27 D in	320 lbs	6-1305280-670	\$6,887.95	6-2027250-670	\$7,752.95
1027-3	1	240	48	10	2350	22-3/8 W x 27 D in	320 lbs	6-1321657-670	\$6,887.95	6-2027251-670	\$7,752.95
1027-3	3	208	31.7	10	2350	22-3/8 W x 27 D in	320 lbs	6-1137089-670	\$7,032.95	6-2027252-670	\$7,892.95
1027-3	3	240	29.3	10	2350	22-3/8 W x 27 D in	320 lbs	6-1302169-670	\$7,032.95	6-2027253-670	\$7,892.95
1227-3	1	208	48	5	2185	28-1/8 W x 27 D in	400 lbs	6-220158-670	\$7,898.95	6-2027254-670	\$8,951.95
1227-3	1	240	48	8	2300	28-1/8 W x 27 D in	400 lbs	6-424499-670	\$7,898.95	6-2027255-670	\$8,951.95
1227-3	3	208	31.7	8	2300	28-1/8 W x 27 D in	400 lbs	6-424502-670	\$8,122.95	6-2027256-670	\$9,354.95
1227-3	3	240	29.3	8	2300	28-1/8 W x 27 D in	400 lbs	6-220161-670	\$8,122.95	6-2027257-670	\$9,354.95

Visit our website: [select.schoolspecialty.com/kilns](http://select.schoolspecialty.com/kilns) to download a kiln ordering specification worksheet

**Skutt Furniture Kits**

**Kit for Model 1027:** eight 5/8"-thick half shelves, 1 large post assortment, 8 oz. bag kiln wash

**Kit for Model 1027-3:** eight 5/8"-thick half shelves, 1 large post assortment, 8 oz. bag kiln wash

**Kit for Model 1218-3:** six 1"-thick half shelves, 1 large post assortment, 8 oz. bag kiln wash

**Kit for Model 1227-3:** eight 1"-thick half shelves, 1 large post assortment, 8 oz. bag kiln wash



Item #	Description	List Price
6-423191-670	Kit for 1027 Kiln	\$938.95
6-460262-670	Kit for 1027-3 Kiln	\$938.95
6-127772-670	Kit for 1218-3 Kiln	\$1,290.95
6-423195-670	Kit for 1227-3 Kiln	\$1,417.95



**Skutt EnviroVent™ 2**

The EnviroVent 2 creates a down draft effect which improves kiln temperature and uniformity. Wall-mounted design keeps the fan motor cool, eliminates vibration, and creates a negative pressure system to remove the fumes before they enter the room. Installs easily on all 8-sided and larger Skutt kilns. UL listed.

Item #	Description	Volts	Ship Weight	List Price
6-409816-670	Kiln Ventilation System	120	17 lbs	\$1,066.95



**Childcraft® Mobile Art Cart**

This versatile art cart moves easily to where it's needed. Two adjustable lower shelves and dual-wheel locking casters. Assembled. 106 lbs.

Item #	Description	Product Dimensions	List Price
6-1457568-670	Mobile Art Cart	30 W x 24 D x 33 H in	\$523.95



**Childcraft® Mobile 3-Shelf Cart**

This stain resistant mobile cart has three shelves, holds paper up to 18"x24" and is easy to clean. Heavy-duty locking casters. Assembled.

Item #	Description	Product Dimensions	List Price
5-271585-670	Mobile 3-Shelf Cart	28W x 19-3/8D x 26-1/8H in	\$551.95



**Childcraft® Mobile Paper Storage and Drying Rack**

This mobile unit includes fourteen shelves that hold paper up to 18" x 24". Heavy-duty locking casters. Assembled.

Item #	Description	Product Dimensions	List Price
6-1291236-670	Mobile Paper Drying Rack	28-5/8 Wx24-1/2 Dx49-5/8 H in	\$752.95



**Childcraft® Locking Mobile Supply Cabinet**

Large enough to store an entire classroom's supplies. Features an adjustable shelf, locking doors, two pullout drawers, and heavy-duty locking casters. Assembled.

Item #	Description	Product Dimensions	List Price
6-204149-670	Mobile Supply Cabinet	36 W x 24 D x 46 H in	\$2,171.95



**Childcraft® Extra-Wide Construction Paper Holder**

All-birch panels. Holds 9 x 12 inch and 12 x 18 inch paper. Assembled.

Item #	Description	Product Dimensions	List Price
5-071988-670	Construction Paper Holder	29-3/8 W x 12-3/4 D x 15 H in	\$306.95



# CHILDCRAFT®

A School Specialty Exclusive



PRODUCT CERTIFIED FOR LOW CHEMICAL EMISSIONS: UL/COM/IGG UL 2818



Double Adjustable Easel with Drying Rack



See-View Easel with Drying Rack

## Childcraft® Double Adjustable Easel

Easel features solid-maple frame with two adjustable easel panels in dry-erase or clear options. Includes cross rails for extra stability, locking metal stay arms to hold the easel open, non-skid rubber feet, four large clips, and two removable paint trays that hold up to ten paint cups. Easel stands 44-1/2" when open. Each panel measures 23-3/4"W x 27-7/8"H and can be adjusted individually at any increment from 39-3/8" to 48-1/2". Tray height will vary from 15-3/4" to 25-1/8". Assembly required. Hardware and instructions included.

## Childcraft® Adjustable Mobile Art Easel

Mobile easel includes two easy-access storage shelves and easy-to-clean, adjustable dry-erase panels on each side for tray heights between 15-3/8" and 23"H from the floor. Two paint trays are removable for easy cleaning. Heavy-duty dual-wheel locking casters. Assembled, except for blue trays.



Item #	Description	List Price
<b>Double Adjustable Easel with Dry-Erase Panels</b>		
5-074493-670	Double Adjustable Easel	\$365.95
5-296213-670	Easel W/ Paper Roll and Holder	\$395.95
5-296312-670	Easel W/ Drying Rack	\$533.95
<b>Double Adjustable Easel with Clear Acrylic Panels</b>		
5-272203-670	See-View Easel	\$530.95
5-150618-670	Easel W/ Paper Roll and Holder	\$547.95
5-296315-670	Easel W/ Drying Rack	\$691.95
<b>Accessories</b>		
9-074996-670	Paper Roll Holder	\$53.95
5-282874-670	Drying Rack	\$189.95
9-271480-670	Blue Easel Tray Replacement	\$18.95

Item #	Description	Quantity	List Price
<b>Replacement Paper Roll 18 in x 75 ft</b>			
9-1326255-670		Each	\$10.69
<b>Replacement Paper Roll 18 in x 200 ft</b>			
9-1369513-670		Each	\$33.29



Two Easel Center



Mobile Four Easel Center

## Childcraft® Two- and Four-Easel Centers

Easel includes bottom shelves for storage and adjustable dry-erase panels on each side for tray heights between 18-1/8" and 29-1/2" from the floor. Paint trays are removable for easy cleaning. Four-Easel Center features heavy-duty casters for mobility. Assembly required. Hardware and instructions included.

Item #	Description	Product Dimensions	List Price
5-271567-670	Two Easel Center	26-1/8 W x 13 D x 49-3/8 H in	\$632.95
6-271543-670	Mobile Four Easel Center	47-3/4 W x 13 D x 50-1/8 H in	\$1,154.95



## Childcraft® Tabletop Painting Easel

Easel made with all-birch panels covered with dry-erase boards. Features no-slide rubber bumper feet, two paint trays that hold up to eight paint cups, and four large clips. Assembly required. Hardware and instructions included.

Item #	Description	Product Dimensions	List Price
5-078120-670	Tabletop Painting Easel	21-5/8 W x 23 D x 22-5/8 H in	\$185.95

## Childcraft® Wall-Mounted Easel

Easel features all-birch panels with white melamine easel surface, built-in clips, and lower ledge that holds eight paint cups. Assembly and mounting required. Hardware and instructions included.



Item #	Description	Product Dimensions	List Price
5-074534-670	Wall-Mounted Easel	48-7/8 W x 10 D x 27-3/8 H in	\$458.95

**QUICKSHIP**  
 24 HRS 48 HRS 1 OR 2 WEEKS  
 Items ship within 24 hrs, 48 hrs, 1 or 2 weeks as indicated when the factory distribution center receives the order.

Items ship **Freight** or **Parcel** See Shipping & Handling terms for details.



### Triangular Table-Top Easel

An inexpensive, compact sturdy easel with Uni-frame construction, will not come apart. Has 4 angle adjustments and folds flat for easy storage. Natural finish. 17 1/2" W x 19" H.

Item #	Description	Dimensions	Quantity	List Price
9-42323-670	Table Easel	17-1/2 W x 19 H in	Each	\$82.95



### Thrifty Wood Folding Easel

Sturdy wooden easel features adjustable tray to hold canvas, heavy-duty chain to secure back leg in place, and nonskid rubber feet. Folds easily for storage. Assembly required. Ship wt. 4 lbs.

Item #	Description	Dimensions	Quantity	List Price
9-434069-670	Pine Easel	68 H in	Each	\$46.95
9-434066-670	Hardwood	66 H in	Each	\$52.95



### Wood Table Easel

School Specialty Wood Table Easel with rubber bumpers has a height of 24". Easel features chain to avoid center leg from slipping back too far.

Item #	Description	Dimensions	Quantity	List Price
9-434063-670	Wood Table Easel	18 W x 24 H in	Each	\$27.95



### Traditional Aluminum Folding Easel

Strong yet lightweight easel with sturdy reinforced frame and stable 3 legged design is perfect for holding large canvases up to 64"H. Top canvas holder is 6"W; bottom is 25"W; both have double sliding locks and black plastic knobs for adjusting height. Legs have non-slip, non-mar rubber feet. 27" bottom spread; 73"H overall. Assembles easily without tools. Ship wt. 10 lbs.

Item #	Description	Dimensions	Quantity	List Price
5-463088-670	Aluminum Easel	25 W x 27 D x 73 H in	Each	\$384.95



### Superior Easel

A real workhorse with built-in flexibility at an affordable price! Durable, lightweight, all-aluminum easel holds paintings up to 86" high. Center support bar tilts forward past vertical to properly hold pastel drawings. Retractable front extensions to hold the palette, plus tool tray for paints and brushes. Ship wt. 8.5 lbs.

Item #	Description	Dimensions	Quantity	List Price
5-230910-670	Artist Easel	24 W x 86 H in	Each	\$307.95

### Economical Aluminum Table Easel

A lightweight and practical easel. Fits into standard 12 W x 16 H in art box when folded. With canvas-holder/support bar.



Item #	Description	Dimensions	Quantity	List Price
9-219879-670	Table Easel	12 W x 16 H in	Each	\$32.95

### Aluminum Table Easel

Lightweight, sturdy, aluminum tubing. Rubber-tipped legs. Hinged bottom rest holds canvases up to 20 x 24 inches. Aluminum top bracket adds extra support. Overall: 19 W in in (24 H in with top open). Collapsible.



Item #	Description	Dimensions	Quantity	List Price
9-410845-670	Aluminum Table Easel	20 W x 19-24 H in	Each	\$49.95

### Aluminum Table or Floor Easel

Lightweight, adjustable aluminum easel is a great value for the student artist. Fully extends as a floor easel or easily adjusts to a table top size. Maximum height of 32". Tray and plastic feet are adjustable for display use. Exceptionally compact: folds up to only 21" long. Includes carrying case with shoulder strap.



Item #	Description	Dimensions	Quantity	List Price
9-410969-670	Aluminum Easel	22 W x 16 D x 60 H	Each	\$48.95

### Classic Aluminum Easel

This extremely sturdy and rigid aluminum studio easel can be set up in only two minutes. So compact and light weight it can be taken on field trips. Accommodates a 48 inch canvas. 21 W in tray. Wt. 7 lbs.



Item #	Description	Dimensions	Quantity	List Price
9-410837-670	Aluminum Easel	24 W x 68 H in	Each	\$182.95





### Creative Minds Economy Drying Rack

Dry up to 15 newly painted "masterpieces" by laying them flat on the shelves. Made of sturdy, blue, powder-coated wire. Free-standing or can be mounted.



Item #	Description	Dimensions	List Price
5-278920-670	Powder-Coated Drying Rack	20-3/4 W x 17 D x 25 H in	\$226.95

### Copernicus Spring-Loaded Drying Rack

A great way to dry and store the masterpieces of budding young artists. Paper catch clips ensure that artwork does not slip out when racks are lifted. The durable metal frame has a tough powder-coat finish and shelf corners are rounded for safety. 20 shelves. Ship weight 50 lbs. Assembly Required.



Item #	Dimensions	List Price
5-406013-670	26-1/2 W x 25 D x 33-1/2 H in	\$399.95

### Bulman 15 Shelf Desktop Drying Rack

**NEW**

User-friendly, lightweight, and durable drying rack with 15 wire trays for all of your storage needs. Red powder coat finish provides exceptional durability and resistance against common damage. Handy carrying handle on top of the unit allows for the rack to be moved with ease for repositioning within a room or across multiple rooms. Ship weight is 19.5 lbs.

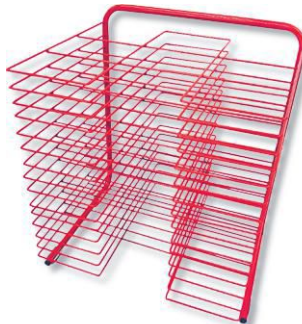

Item #	Description	Dimensions	Quantity	List Price
6-2106294-670	Red Powder Coat	21-1/2 W x 18 L x 24 H in	Each	\$299.95

### A.W.T. Rack-It™ Drying & Storage Racks

Heavy-duty racks featuring long-lasting steel bumpers welded to the outside of the shelf to allow more drying room. Each shelf spring is individually adjustable so you can control the up/down operation. The powder coated shelf finish is rust and solvent-resistant to ensure a long service life. Shelves are non-warping and spaced at 1 inch intervals to maximize solvent evaporation. Durable casters provide mobility.



Item #	Description	Dimensions	List Price
6-409474-670	40 Shelf Drying Rack	38-1/2 W x 32 D x 59 H in	\$8,839.95
6-409475-670	50 Shelf Drying Rack	38-1/2 W x 32 D x 69 H in	\$5,999.95
6-409476-670	40 Shelf Drying Rack	50-1/4 W x 33-1/2 D x 68-1/4 H	\$9,639.95
6-233067-670	40 Shelf Drying Rack	51-3/4 W x 36-1/2 D x 57-3/4 H	\$9,199.95
6-410972-670	50 Shelf Drying Rack	51-3/4 W x 36-1/2 D x 68-1/4 H	\$11,199.95



### Table Top Rack

All-purpose double-sided racks feature welded all-steel wire construction with baked enamel finish. Rigid shelves are spaced 1 inch apart to accommodate paper, cardboard, plastic, etc. Comes fully assembled. Features 50 shelves, 9 x 16 inches each. Overall dimensions: 17-1/2 inch W x 20 inch D x 30-3/4 inch H.

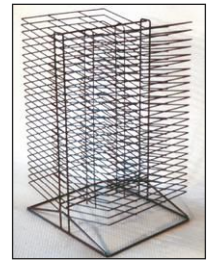

Item #	Description	Dimensions	List Price
5-216782-670	50-Shelf Double Sided Rack	17-1/2 W x 20 D x 30-3/4 H in	\$299.95

### Mobile Drying Rack

Compact and portable. Comes with forty 18 x 24 inch shelves constructed of steel with baked enamel finish. Unit features front bumpers that provide proper spacing, up and down portability. Ball-bearing swivel casters are provided for easy mobility. Shipped knocked down in 1 container.



Item #	Dimensions	List Price
9-408116-670	25 x 26 in	\$319.95

### Stack-a-Rack

A modular steel drying rack system that can grow as your needs grow. Each unit consists of 25 wire shelves measuring 19 x 12 inch spaced 1 inch apart with 6 x 6 inch mesh. A single unit can be used as a table rack or mounted to a door or wall (wall mounting hardware included). Two units can be attached back to back as a table rack. Two sets of back-to-back racks can be stacked on top of a caster package (included) to make a 100 shelf mobile floor unit. Each rack features a red powder coat finish. Ship weight. 24 lbs.



Item #	Dimensions	List Price
9-408117-670	20-1/8 W x 12-7/8 D x 29-1/4 H in	\$266.95

### Saturn Rack Tensor-18™

Perfect for commercial shops, educational and institutional use, Saturn's re-engineered Tensor-18 combines both economy and mobility. The Tensor-18 is re-engineered with features including clean power coated shelves, thicker gauge steel wire shelves, newly sized mesh to better hold small parts, backstop wires to catch items that may fall behind the unit, a retaining strip to hold shelves in place and larger bumpers for additional shelf support. The Saturn Tensor-18's versatile rack features deep trays - 18 x 24 inches, and solid steel construction with two rubber tray bumpers, allowing for sufficient space for airflow between the shelves. The Saturn Tensor-18 also has a positive locking mechanism: Original TrayLock, which holds the rack firmly in place after it is lifted up to adjust or move substrates. The Tensor-18's four casters swivel with ease and its mobility makes it invaluable in organizing under the most restrictive classroom configurations.



Item #	Description	Dimensions	Ship Weight	List Price
6-1441341-670	40 Shelf Drying Rack	22-1/2 W x 25 D x 45-1/2 H in	72 lbs	\$3,016.95
6-1441342-670	80 Shelf Industrial Rack	39-1/4 W x 25 D x 45-1/2 H in	130 lbs	\$5,972.95



# music room



projects by design™

**CLASSROOM  
SELECT**



PRODUCT CERTIFIED  
FOR LOW CHEMICAL  
EMISSIONS:  
UL.COM/GG  
UL 2818



PLEASE  
SPECIFY  
COLOR  
CHOICE

Refer to pages 60-61  
for color options.



## Classroom Select® Contemporary Music Chair

Maximize your students' musical success with this well-fitted, ergonomic soft plastic chair that features a special angled frame to encourage proper posture. Offered in 18" A+ and 18" shell with or without seat and back pads. Select from nylon, steel, felt, or rubber glide options.

Item #	Seat Height	Seat Color	Fabric Color	Frame Color	Glide/Caster Type	List Price
6-1444526-670	18 in A+	Specify	Specify	Chrome	Specify	\$199.95
6-1444527-670	18 in A+	Specify	Specify	Black	Specify	\$192.95
6-1441273-670	18 in A+	Specify	-	Chrome	Specify	\$132.95
6-1441274-670	18 in A+	Specify	-	Black	Specify	\$126.95
6-1444524-670	18 in	Specify	Specify	Chrome	Specify	\$192.95
6-1444525-670	18 in	Specify	Specify	Black	Specify	\$186.95
6-1441271-670	18 in	Specify	-	Chrome	Specify	\$126.95
6-1441272-670	18 in	Specify	-	Black	Specify	\$119.95



Shown with Optional  
Seat and Back Pad



## Classroom Select® Traditional Music Chair

The traditional music chair brings function and durability to your music room. The back legs are positioned at the proper angle to provide proper posture. Rear leg structure combines special bends which allow more aisle space on risers. Offered in 18-1/2" A+ and 17-1/2" seat heights. Select from nylon, steel, felt, or rubber glide options.

Item #	Seat Height	Seat Color	Frame Color	Glide/Caster Type	List Price
6-1441269-670	18-1/2 in A+	Specify	Chrome	Specify	\$132.95
6-1441270-670	18-1/2 in A+	Specify	Black	Specify	\$126.95
6-1441267-670	17-1/2 in	Specify	Chrome	Specify	\$126.95
6-1441268-670	17-1/2 in	Specify	Black	Specify	\$119.95







**A**  
Melody Black Music Chair

**D**  
Melody Music Stand



**B**  
Optional Tablet Arm



**E**  
Melody Music Stand Dolly (Capacity 10)



**C**  
Melody Chair Dolly



**F**  
Melody Music Stand Dolly (Capacity 20)

### National Public Seating® Melody Music Chair and Stand

The Melody Chair meets the unique demands of the musical performance equipment. It has a band pitch style seat to back angle of 97 degrees allowing for maximum breathing capability. The optional tablet arm adjusts to 4 positions: writing, upright, entry, and behind. The optional Melody chair dolly stacks up to 18 chairs. Also available is this durable music stand made with strong 22-gauge aluminum and has rolled steel edges to protect instruments and preserve the stand. Whisper glides prevent noise and floor scratching. No tools necessary for assembly. It is coated with a black textured finish that resists scratches and chipping. The stand vertically adjusts from 24" to 46" (lip to floor), and the surface desk features tension tilt. The optional music stand dolly is available in either a 10 or 20 capacity model.

Item #	Product Dimensions	List Price
<b>A</b> / 5-678773-670	19 W x 21-1/2 D x 33-1/2 H in	\$124.95
Item #	Description	List Price
<b>B</b> / 5-678774-670	Optional Tablet Arm	\$129.95
<b>C</b> / 5-678775-670	Stack Chair Dolly	\$407.95
<b>D</b> / 5-679326-670	Music Stand	\$93.95
<b>E</b> / 5-1298968-670	Music Stand Dolly Capacity 10	\$564.95
<b>F</b> / 5-1298969-670	Music Stand Dolly Capacity 20	\$761.95

### National Public Seating® Portable Stage and Seated Riser Accessories

The NPS Stage steps are made of high-grade plywood edged in vinyl t-molding, Polypropylene textured gray surface and handrails prevent users from slipping. The black frame is built with 14-gauge steel tubing, rolls on two wheels for easy setup, and clamps securely to the stage at any point. Choose one of three convenient heights to match 16", 24" and 32" stage setups. The guardrails are black in color, and available in different sizes. Recommended while using any of our stages or risers to ensure safety. Skirting is available in Box or Shirred pleat styles and comes in various sizes and colors to complete your look. Skirting includes mating hook and loop. The stage dolly is built with 14-gauge tubular steel on four 5" casters that allow you to store and transport up to six 36" or 48" stage sections safely and conveniently.



ADA ramps available.  
Call your territory manager.

Guard Rails for NPS Stages



Steps for NPS Stages



Stage Dolly



Item #	Description	Color	List Price
Guardrails/Handrails			
6-1296561-670	Stage Guardrail 36 in	Black	\$169.95
6-1283523-670	Stage Guardrail 48 in	Black	\$204.95
Steps			
6-1283519-670	Stage Steps w/ Handrails 16in	Black	\$623.95
6-1283520-670	Stage Steps w/ Handrails 24in	Black	\$955.95
6-1306926-670	Stage Steps w/ Handrails 32in	Black	\$1,233.95
Skirting			
5-1283534-670	Stage Skirt Box 16x36 in	Specify	\$133.95
6-5008498-670	Stage Skirt Box 16x48 in	Specify	\$189.95
6-1283535-670	Stage Skirt Box 24x36 in	Specify	\$145.95
6-5008501-670	Stage Skirt Box 24x48 in	Specify	\$189.95
6-1372069-670	Stage Skirt Box 32x36 in	Specify	\$187.95
6-5008502-670	Stage Skirt Box 32x48 in	Specify	\$249.95
6-1372068-670	Stage Skirt Box 8x36 in	Specify	\$133.95
6-5008504-670	Box-Pleat Skirt 8 in H	Specify	\$189.95
5-1283532-670	Stage Skirt Shirred 16x36 in	Specify	\$106.95
6-1283533-670	Stage Skirt Shirred 24x36 in	Specify	\$131.95
6-5008507-670	Stage Skirt Shirred 24x48 in	Specify	\$174.95
6-1372589-670	Stage Skirt Shirred 32x36 in	Specify	\$155.95
6-5008512-670	Shirred-Pleat Skirt 32inH	Specify	\$206.95
6-1372070-670	Stage Skirt Shirred 8x36 in	Specify	\$119.95
6-5008509-670	Stage Skirt Shirred 8x48 in	Specify	\$159.95
6-5008513-670	Shirred-Pleat Skirt 16inH	Specify	\$159.95
Dollies			
6-1296560-670	Stage Dolly	Black	\$1,721.95

PLEASE SPECIFY COLOR CHOICE

#### Stage Skirting Colors



#### Stage Skirting Styles





Use Stage Pies to create a custom stage configurations

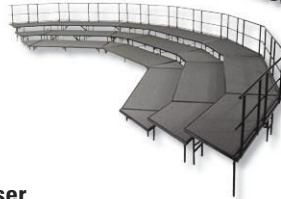
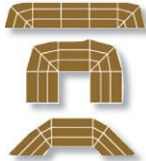

Stage Carpet Colors



National Public Seating® Portable Stages and Seated Riser

Whether your venue requires single height portable stages, multiple levels, or entire stage configurations, National Public Seating offers affordable prices, quick ship and superior craftsmanship to provide you with the best value. Built with 16-gauge steel frames and premium grade plywood core, these carpeted or hardboard stages are durable and portable. Legs are made with 14-gauge tubular steel and outfitted with spring-loaded easy to open and close support brackets, for quick set-up and safe use. Portable Stages/Seated Riser configurations in ring, oval, or bow styles are put together using multiple stage sets and pie-shaped units. Each unit is available in 36" or 48" wide, with multiple height options. Accessories sold separately.

Item #	Product Dimensions	Shape	Flooring Type	Carpet Color	List Price
6-1372584-670	96 W x 36 L x 8 H in	Rectangle	Carpet	Specify	\$1,119.95
6-1372586-670	96 W x 36 L x 16 H in	Rectangle	Carpet	Specify	\$1,188.95
6-1372587-670	96 W x 36 L x 24 H in	Rectangle	Carpet	Specify	\$1,238.95
6-1372588-670	96 W x 36 L x 32 H in	Rectangle	Carpet	Specify	\$1,295.95
6-1372060-670	96 W x 48 L x 8 H in	Rectangle	Carpet	Specify	\$1,534.95
6-1283521-670	96 W x 48 L x 16 H in	Rectangle	Carpet	Specify	\$1,622.95
6-1283522-670	96 W x 48 L x 24 H in	Rectangle	Carpet	Specify	\$1,659.95
6-1372061-670	96 W x 48 L x 32 H in	Rectangle	Carpet	Specify	\$1,722.95
6-1372095-670	96 W x 36 L x 8 H in	Triangle	Hardboard	-	\$575.95
6-1372096-670	96 W x 36 L x 16 H in	Isosceles Trapezoid	Hardboard	-	\$731.95
6-1372097-670	96 W x 36 L x 24 H in	Isosceles Trapezoid	Hardboard	-	\$994.95

Item #	Product Dimensions	Shape	Flooring Type	Carpet Color	List Price
6-1372092-670	96 W x 36 L x 8 H in	Rectangle	Hardboard	-	\$888.95
6-1372093-670	96 W x 36 L x 16 H in	Rectangle	Hardboard	-	\$935.95
6-1372094-670	96 W x 36 L x 24 H in	Rectangle	Hardboard	-	\$971.95
6-1306925-670	96 W x 36 L x 32 H in	Rectangle	Hardboard	-	\$999.95
6-1325518-670	96 W x 48 L x 8 H in	Rectangle	Hardboard	-	\$1,173.95
6-1325523-670	96 W x 48 L x 16 H in	Rectangle	Hardboard	-	\$1,338.95
6-1325522-670	96 W x 48 L x 24 H in	Rectangle	Hardboard	-	\$1,338.95
6-1306924-670	96 W x 48 L x 32 H in	Rectangle	Hardboard	-	\$1,404.95
6-1442295-670	36 W x 36 L x 32 H in	Pie	Hardboard	-	\$1,747.95
6-1442483-670	48 W x 36 L x 32 H in	Pie	Hardboard	-	\$1,828.95

National Public Seating® Trans-Port Riser

The Trans-Port is a unitized three-level carpeted Choral Riser that conveniently allows set-up in seconds!

Built-in wheels makes it easy to transport from room to room and load into a vehicle. Multiple units can be connected, using all straight or all tapered units. Comes in Aluminum Frame and Grey carpet surface.



Item #	Product Dimensions	Shape	Flooring Type	Carpet Color	List Price
6-1283516-670	72 L x 54 D x 24 H in	Straight	Carpet	Grey	\$1,688.95
6-1283517-670	60 L x 54 D x 24 H in	Tapered	Carpet	Grey	\$1,688.95

Item #	Description	List Price
6-1283518-670	Back Guard Rails	\$368.95
6-1442293-670	Side Guardrail for 3-Level	\$175.95
6-1442294-670	Side Guardrail for 4 Level	\$192.95
6-1491106-670	4th Level Rear Guardrail	\$445.95
6-1388215-670	4th Level Tapered Add-On	\$823.95

NPS Transport Riser - Flip Open and Set up!!





### National Public Seating® Stage Group

The Portable Stage Group is the reliable and affordable choice for your school performances and assemblies. Users are supported by a heavy-duty, 16-gauge steel and a black powder-coated frame. The premium 3/4" thick plywood deck is durable and features a firmly-affixed carpeted or hardboard surface. Legs are constructed with 14-gauge steel tubing and feature simple and safe spring-loaded locking mechanisms allowing for quick set-up assembly and folds up easily for manageable portable storage. The stage offers a secure weight capacity of over 200 lbs. per square foot. High-impact plastic glides will ensure floors are protected from damage. This set includes two stage steps, 14-gauge guardrails for extra safety, and skirting for an elegant look.

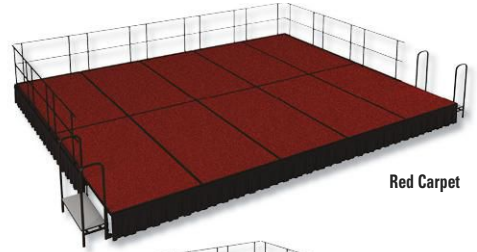

Red Carpet

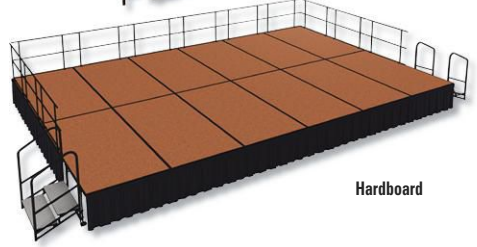

Hardboard

Item #	Product Dimensions	Flooring Type	Carpet Color	List Price
6-2009310-670	144 W x 96 L x 24 H in	Hardboard	-	\$7,840.95
6-2009311-670	192 W x 96 L x 24 H in	Hardboard	-	\$9,388.95
6-2009312-670	240 W x 192 L x 16 H in	Hardboard	-	\$18,344.95
6-2009313-670	240 W x 192 L x 24 H in	Hardboard	-	\$19,195.95
6-2009314-670	240 W x 192 L x 32 H in	Hardboard	-	\$20,838.95
6-2009309-670	288 W x 192 L x 24 H in	Hardboard	-	\$22,209.95
6-5000489-670	240 W x 192 L x 24 H in	Carpet	Specify	\$20,661.95
6-5000490-670	240 W x 192 L x 32 H in	Carpet	Specify	\$22,251.95



Please refer to page 94 for all color selections.



### National Public Seating® Portable Standing Choral Risers

The Portable Choral Standing Risers are easy to set up and allow for quick arrangement for all performance venues. Units easily attach to one another to provide multi level heights. Available in both straight and tapered units, allowing for continuous or semi-circle arrangements.

Item #	Product Dimensions	Shape	Flooring Type	Carpet Color	List Price
6-1372071-670	96 L x 18 D x 8 H in	Straight	Carpet	Specify	\$680.95
6-1372072-670	96 L x 18 D x 16 H in	Straight	Carpet	Specify	\$735.95
6-1372073-670	96 L x 18 D x 24 H in	Straight	Carpet	Specify	\$735.95
6-1372074-670	96 L x 18 D x 32 H in	Straight	Carpet	Specify	\$770.95
6-1372075-670	96 L x 18 D x 8 H in	Tapered	Carpet	Specify	\$483.95
6-1372076-670	96 L x 18 D x 16 H in	Tapered	Carpet	Specify	\$526.95
6-1372077-670	96 L x 18 D x 24 H in	Tapered	Carpet	Specify	\$566.95
6-1372078-670	96 L x 18 D x 32 H in	Tapered	Carpet	Specify	\$713.95
6-1372079-670	96 L x 18 D x 8 H in	Straight	Hardboard	-	\$687.95
6-1372080-670	96 L x 18 D x 16 H in	Straight	Hardboard	-	\$752.95
6-1372081-670	96 L x 18 D x 24 H in	Straight	Hardboard	-	\$752.95
6-1372082-670	96 L x 18 D x 32 H in	Straight	Hardboard	-	\$766.95
6-1372083-670	96 L x 18 D x 8 H in	Tapered	Hardboard	-	\$533.95
6-1372084-670	96 L x 18 D x 16 H in	Tapered	Hardboard	-	\$591.95
6-1372085-670	96 L x 18 D x 24 H in	Tapered	Hardboard	-	\$628.95
6-1372086-670	96 L x 18 D x 32 H in	Tapered	Hardboard	-	\$660.95

Item #	Description	List Price
6-1372087-670	2 Level Side Guardrail	\$157.95
6-1361104-670	3 Level Side Guardrail	\$170.95
6-1372088-670	4 Level Side Guardrail	\$186.95
6-1283530-670	24 in Tapered Rear Guardrail	\$315.95
6-1283528-670	24 in Straight Rear Guardrail	\$352.95
6-1283531-670	32 in Tapered Rear Guardrail	\$338.95
6-1283529-670	32 in Straight Rear Guardrail	\$374.95



### SICO® Harmony Choral Risers

All Choral Risers come with the attached back-rail, for added security. This important feature also folds down over the unit to keep steps secure in the transport position.

Item #	Product Dimensions	Carpet Color	List Price
<b>3-Step Riser</b>			
6-1542485-670	73-5/8W x 56-1/2L x 67-7/8H in	Specify	\$5,903.95
<b>4-Step Riser</b>			
6-1542486-670	79-1/8W x 73-5/8L x 75H in	Specify	\$6,448.95

#### SICO® Harmony Choral Risers Carpet Colors



PRODUCT CERTIFIED FOR LOW CHEMICAL EMISSIONS: UL.COM/IGG UL 2818





# science



## CLASSROOM SELECT

### Classroom Select® Hybrid Science Tables

Featuring a hybrid frame with 2-1/2" square steel legs attached by 5/16" hanger bolts, the Classroom Select® Hybrid Science Tables offer a durable, lasting option for your science room setting and is backed by a limited lifetime warranty. Available in multiple sizes and leg heights, as well as a dual book box option. Hybrid table legs are available in a variety of color options for tops as well as edges. Casters and an ADA compliant apron-cutout option, as well as custom sizes, are also available upon special request.

Item #	Product Dimensions	Top Color	Edge Color	Leg Color	List Price
<b>Non-Chem Res. Laminate Hybrid</b>					
6-5009131-670	54 W x 24 D x 30 H in	Specify	Specify	Specify	\$890.95
6-5009132-670	60 W x 24 D x 30 H in	Specify	Specify	Specify	\$910.95
<b>Non-Chem Res. Laminate Hybrid with Bookboxes</b>					
6-5009134-670	54 W x 24 D x 30 H in	Specify	Specify	Specify	\$1,065.95
6-5009141-670	54 W x 24 D x 30 H in	Specify	Specify	Specify	\$1,080.95
<b>ChemGuard Hybrid</b>					
6-5009136-670	54 W x 24 D x 30 H in	Black	Specify	Specify	\$990.95
6-5009138-670	60 W x 24 D x 30 H in	Black	Specify	Specify	\$1,015.95
<b>ChemGuard Hybrid with Bookboxes</b>					
6-5009139-670	54 W x 24 D x 30 H in	Black	Specify	Specify	\$1,170.95
6-5009140-670	54 W x 24 D x 30 H in	Black	Specify	Specify	\$1,175.95
<b>Epoxy Hybrid</b>					
6-5009130-670	54 W x 24 D x 30 H in	Black	-	Specify	\$1,487.95
6-5009133-670	60 W x 24 D x 30 H in	Black	-	Specify	\$1,670.95
<b>Epoxy Hybrid with Bookboxes</b>					
6-5009135-670	54 W x 24 D x 30 H in	Black	-	Specify	\$1,719.95
6-5009137-670	60 W x 24 D x 30 H in	Black	-	Specify	\$1,782.95

#### Classroom Select® Hybrid Science Table Top Color

PLEASE SPECIFY COLOR CHOICE

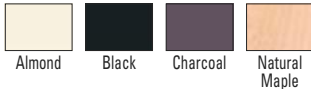

#### Classroom Select® Hybrid Science Table Leg Color



#### Classroom Select® Hybrid Science Table Edge Color

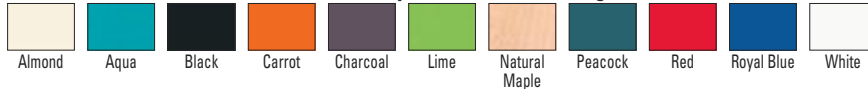

### Diversified Spaces™ Metal Table

This sturdy metal table features a 1" x 2", 16-gauge apron frame that is strong enough for a phenolic resin top. The frame features a 14-gauge outer tube with a 16-gauge insert legs that are height adjustable from 23"H to 37"H. Legs are 1-1/4" square. ADA compliant.

Item #	Product Dimensions	Top Type	List Price
6-2024841-670	54W x 24D x 23-37H in	Phenolic	\$1,417.95
6-2024840-670	60W x 24D x 23-37H in	Phenolic	\$1,500.95
6-2024803-670	60W x 30D x 23-37H in	Phenolic	\$1,713.95
6-2024843-670	60W x 42D x 23-37H in	Phenolic	\$2,042.95
6-2024842-670	72W x 30D x 23-37H in	Phenolic	\$1,861.95
6-2024839-670	72W x 36D x 23-37H in	Phenolic	\$2,097.95



**CLASSROOM  
SELECT** 



**Classroom Select® Science Tables**

Featuring a solid oak frame, with 2-1/4" x 2-1/4" legs secured by a single bolt leg attachment, the Classroom Select® Science Tables offer a durable, lasting option for your science room setting, backed by a limited lifetime warranty. Available in multiple sizes and leg heights, as well as a dual book box option. Casters and an apron-cutout option, as well as custom sizes, are also available upon special request. Contact your School Specialty representative to discuss these optional features.

**High-Pressure Laminate:** Wears exceptionally well under normal use. Offers superior resistance to scratching, with limited resistance to high temperatures and severe chemicals. Edges are finished with vinyl T-Mold edge banding.

**ChemGuard:** A Durable, chemical resistant grade of high pressure laminate. Edges are finished with a 3 mm PVC molding, sealed with heat sensitive adhesive to create an attractive waterproof and durable edge.

**Phenolic Resin:** A chemical resistant composite that will not stain or etch when exposed to most chemicals or solvents. Not recommended for use with high temperatures. Exposed edges and corners are finished with a 1/8" bevel.

**Epoxy Resin:** Impervious to normal laboratory chemicals and heat. Its monolithic composition eliminates the possibility of swelling, lamination issues and exposure of the substrate. Exhibits no effect when subjected to most common laboratory chemicals.

Item #	Product Dimensions	Top Color	List Price
<b>Non-Chem Res. Laminate</b>			
6-657673-670	48 W x 24 D x 30 H in	Black	\$719.95
6-657674-670	54 W x 24 D x 30 H in	Black	\$759.95
6-657675-670	60 W x 24 D x 30 H in	Black	\$799.95
6-1290056-670	60 W x 30 D x 30 H in	Black	\$839.95
6-1487342-670	48 W x 24 D x 36 H in	Black	\$759.95
6-1361616-670	54 W x 24 D x 36 H in	Black	\$799.95
6-1552584-670	60 W x 24 D x 36 H in	Black	\$839.95
<b>Non-Chem Res. Laminate with Bookboxes</b>			
6-672461-670	48 W x 24 D x 30 H in	Black	\$872.95
6-672462-670	54 W x 24 D x 30 H in	Black	\$912.95
6-672463-670	60 W x 24 D x 30 H in	Black	\$952.95
6-1552590-670	48 W x 24 D x 36 H in	Black	\$912.95
6-1367770-670	54 W x 24 D x 36 H in	Black	\$952.95
6-1552591-670	60 W x 24 D x 36 H in	Black	\$992.95
<b>ChemGuard</b>			
6-657677-670	48 W x 24 D x 30 H in	Black	\$786.95
6-568157-670	54 W x 24 D x 30 H in	Black	\$826.95
6-568160-670	60 W x 24 D x 30 H in	Black	\$866.95
6-1129116-670	60 W x 30 D x 30 H in	Black	\$906.95
6-1495235-670	48 W x 24 D x 36 H in	Black	\$826.95
6-1327440-670	54 W x 24 D x 36 H in	Black	\$866.95
6-1290245-670	60 W x 24 D x 36 H in	Black	\$906.95
6-1307056-670	60 W x 30 D x 36 H in	Black	\$946.95
<b>ChemGuard with Bookboxes</b>			
6-672464-670	48 W x 24 D x 30 H in	Black	\$939.95
6-672465-670	54 W x 24 D x 30 H in	Black	\$979.95
6-672466-670	60 W x 24 D x 30 H in	Black	\$1,019.95
6-1358771-670	60 W x 30 D x 30 H in	Black	\$1,059.95
6-1552593-670	48 W x 24 D x 36 H in	Black	\$979.95
6-1298629-670	54 W x 24 D x 36 H in	Black	\$1,019.95
6-1552594-670	60 W x 24 D x 36 H in	Black	\$1,059.95
6-1548588-670	60 W x 30 D x 36 H in	Black	\$1,099.95

Item #	Product Dimensions	Top Color	List Price
<b>Phenolic Resin</b>			
6-678246-670	48 W x 24 D x 30 H in	Black	\$886.95
6-678247-670	54 W x 24 D x 30 H in	Black	\$926.95
6-678248-670	60 W x 24 D x 30 H in	Black	\$966.95
6-1129117-670	60 W x 30 D x 30 H in	Black	\$1,006.95
6-1380949-670	48 W x 24 D x 36 H in	Black	\$926.95
6-1552586-670	54 W x 24 D x 36 H in	Black	\$966.95
6-1411346-670	60 W x 24 D x 36 H in	Black	\$1,006.95
6-1552587-670	60 W x 30 D x 36 H in	Black	\$1,046.95
<b>Phenolic Resin with Bookboxes</b>			
6-678249-670	48 W x 24 D x 30 H in	Black	\$1,039.95
6-678250-670	54 W x 24 D x 30 H in	Black	\$1,079.95
6-678251-670	60 W x 24 D x 30 H in	Black	\$1,119.95
6-1552595-670	60 W x 30 D x 30 H in	Black	\$1,159.95
6-1552596-670	48 W x 24 D x 36 H in	Black	\$1,079.95
6-1552597-670	54 W x 24 D x 36 H in	Black	\$1,119.95
6-1552598-670	60 W x 24 D x 36 H in	Black	\$1,159.95
6-1552599-670	60 W x 30 D x 36 H in	Black	\$1,199.95
<b>Epoxy</b>			
6-657679-670	48 W x 24 D x 30 H in	Black	\$1,119.95
6-657680-670	54 W x 24 D x 30 H in	Black	\$1,159.95
6-657681-670	60 W x 24 D x 30 H in	Black	\$1,199.95
6-1129118-670	60 W x 30 D x 30 H in	Black	\$1,239.95
6-530362-670	48 W x 24 D x 36 H in	Black	\$1,159.95
6-1129121-670	54 W x 24 D x 36 H in	Black	\$1,199.95
6-530363-670	60 W x 24 D x 36 H in	Black	\$1,239.95
6-1326057-670	60 W x 30 D x 36 H in	Black	\$1,279.95
<b>Epoxy with Bookboxes</b>			
6-672467-670	48 W x 24 D x 30 H in	Black	\$1,272.95
6-672468-670	54 W x 24 D x 30 H in	Black	\$1,312.95
6-672469-670	60 W x 24 D x 30 H in	Black	\$1,352.95
6-1491585-670	60 W x 30 D x 30 H in	Black	\$1,392.95
6-1552600-670	48 W x 24 D x 36 H in	Black	\$1,312.95
6-1552601-670	54 W x 24 D x 36 H in	Black	\$1,352.95
6-1357718-670	60 W x 24 D x 36 H in	Black	\$1,392.95
6-1552602-670	60 W x 30 D x 36 H in	Black	\$1,432.95





**Diversified Spaces™ Economy Mobile Lab Table**

Cabinet is constructed from solid oak and oak veneers with a clear chemical resistant finish. The unit features unbreakable aluminum sliding door glides and lock. 1-1/4" HP-laminate top has a chemical resistant sink with a stainless steel look, hand pump and two rod sockets. Unit also includes full upright set, GFI protected AC duplex electrical outlet, 25' extension cord, two water bottles with connecting hoses and 4" ball bearing swivel casters which lock.

Dimensions: 48" W x 24" D x 36" H. Weight: 185 lbs.

Item #	Product Dimensions	List Price
6-657684-670	48 W x 24 D x 36 H in	\$2,990.95
Item #	Description	List Price
9-568163-670	Mirror	\$210.95
9-568166-670	Optional Mirror/Markerboard	\$248.95



**Diversified Spaces™ Mobile Demonstration Table with Drawers**

A self-contained demonstration center with its own water supply, waste container, chemical resistant sink with a stainless steel look and hand pump, GFI protected AC duplex electrical receptacle, 25' extension cord and full 3/4" upright rod and 1/2" crossbar set. The unit includes four drawers which are dovetailed and mounted on epoxy coated glides. Sliding, locking doors conceal the drawers and storage compartment, and the supplied two 2-1/2 gallon water bottles. Finished with a chemical resistant, earth-friendly UV finish. Heavy-duty 4" locking ball-bearing swivel casters support 500 lbs. The top is 1-1/4" ChemGuard high-pressure laminate. Overall dimensions: 48" W x 28" D x 36" H.

Item #	Description	Color	List Price
6-657685-670	Mobile Demo Table	Oak	\$3,548.95
9-568163-670	Optional Adjustable Mirror	Oak	\$210.95
9-568166-670	Optional Mirror/Markerboard	-	\$248.95

**Diversified Spaces™ ADA-Compliant Mobile Lab Station**

This self contained unit constructed of oak and oak veneers is designed to be wheelchair accessible. The 1-1/4" ChemGuard top has a chemical-resistant plastic sink with a stainless-steel look, faucet, rod sockets that support the full upright set which is included. The faucet is operated by a toggle switch water pump which pulls and discards the water from the water bottles supplied. Unit has a GFI protected AC duplex electrical receptacle, 25' extension cord and locks on all the drawers and doors. Rolls easily on 4" ball bearing locking swivel casters. Dimensions: 72" W x 24" D x 33" H.

Item #	Description	List Price
6-572404-670	ADA Compatible Mobile Lab	\$4,965.95
9-568163-670	Optional Adjustable Mirror	\$210.95
9-568166-670	Optional Mirror/Markerboard	\$248.95



**Diversified Spaces™ Mobile Desk with Storage**

This mobile desk is equipped with three drawers (one file, two box) that have dovetail joints and run smoothly on epoxy-coated steel glides. Includes pullout writing board and all drawers and doors have locks. This unit features a 1-1/4" chemical resistant ChemGuard top, 21" W x 28" H pegboard and assorted hooks for vertical storage. A GFI protected AC duplex electrical outlet is built into the lab. Unit has four heavy-duty 4" locking swivel casters. There is a storage area for the optional mirror/markerboard. It is finished with a chemical resistant, earth friendly UV finish. Dimensions: 48" W x 28" D x 36" H.



Item #	Product Dimensions	List Price
<b>Desk with Flat Top</b>		
6-679320-670	48 W x 28 D x 36 H in	\$3,370.95
<b>Desk with Sink</b>		
6-568154-670	48 W x 28 D x 36 H in	\$4,301.95
Item #	Description	List Price
9-568163-670	Mirror	\$210.95
9-568166-670	Optional Mirror/Markerboard	\$248.95



### Diversified Spaces™ ForwardVision™ I 4-Student Workstation

Unlike typical 4-student workstations that hide students' faces and storage areas, this workstation's unparalleled design provides the instructor with optimum visibility. Instructors can see the students, fixtures and storage areas from the front of the classroom. The students all work from the same side of the workstation, while the storage area is on the opposite side. The solid epoxy resin top withstands extreme chemicals and heat. Workstation features two electrical outlets and is available with or without a sink and fixtures.

Item #	Product Dimensions	Top Type	List Price
<b>Without Sink</b>			
6-598936-670	96 W x 50 D x 36 H in	Epoxy Resin	\$7,024.95
<b>With Sink</b>			
6-598933-670	96 W x 50 D x 36 H in	Epoxy Resin	\$9,445.95

### Diversified Spaces™ Fab-Lab Workbench

The Fab-Lab Workbench offers multiple top finishes including high pressure laminate (HPL), ChemGuard, maple butcher block, and phenolic or epoxy resin with colored 3mm PVC edge banding options on the HPL and ChemGuard tops. The workbench apron is constructed of 16-gauge with end gusset geometry for additional support with the top being attached with screws in two directions to ensure stability. Legs are attached with bolts in the field. An additional 14-gauge steel stretcher bar provides additional rigidity to the table frame, and can be installed on the front, middle, or back of the leg frame. The legs are constructed of 2" X 2" square steel outer tubes that were welded together with both upper and lower cross braces; 1-3/4" x 1-3/4" square steel 14-gauge steel inner tubes with riv-nuts spaced 1" on-center to provide adjustable heights from 29-1/4"H to 36-1/4"H with glides and a 1" thick top. The workbench is equipped with adjustable glides for precise leveling. Optional casters available; add 4" to the height. Optional color coordinated 12" deep shelf made from 14-gauge steel.



Item #	Product Dimensions	Top Type	Top Color	Edge Color	Panel Color	List Price
<b>Laminate</b>						
6-5008783-670	60 W x 30 D in	Laminate	Specify	Specify	-	\$1,373.95
6-5008788-670	72 W x 30 D in	Laminate	Specify	Specify	-	\$1,501.95
6-5008793-670	96 W x 30 D in	Laminate	Specify	Specify	-	\$1,762.95
<b>ChemGuard</b>						
6-5008784-670	60 W x 30 D in	ChemGuard	Black	Specify	-	\$1,403.95
6-5008789-670	72 W x 30 D in	ChemGuard	Black	Specify	-	\$1,596.95
6-5008794-670	96 W x 30 D in	ChemGuard	Black	Specify	-	\$2,154.95
<b>Phenolic</b>						
6-5008785-670	60 W x 30 D in	Phenolic Resin	Black	-	-	\$1,624.95
6-5008790-670	72 W x 30 D in	Phenolic Resin	Black	-	-	\$1,818.95
6-5008795-670	96 W x 30 D in	Phenolic Resin	Black	-	-	\$2,270.95
<b>Epoxy Resin</b>						
6-5008787-670	60 W x 30 D in	Epoxy	Black	-	-	\$2,225.95
6-5008792-670	72 W x 30 D in	Epoxy	Black	-	-	\$2,529.95
6-5008797-670	96 W x 30 D in	Epoxy	Black	-	-	\$3,219.95
<b>Butcher Block</b>						
6-5008786-670	60 W x 30 D in	Maple Butcher Block	Maple	-	-	\$1,798.95
6-5008791-670	72 W x 30 D in	Maple Butcher Block	Maple	-	-	\$2,205.95
6-5008796-670	96 W x 30 D in	Maple Butcher Block	Maple	-	-	\$2,800.95
<b>Shelves</b>						
6-5008798-670	60 W x 12 D in	-	-	-	Specify	\$330.95
6-5008799-670	72 W x 12 D in	-	-	-	Specify	\$342.95
6-5008800-670	96 W x 12 D in	-	-	-	Specify	\$384.95
<b>Item #</b>	<b>Description</b>					<b>List Price</b>
6-2026961-670	Casters Set of 4					\$361.95



**Diversified Spaces™ Stainless-Steel Table**

Stainless-steel table with galvanized-steel legs and under shelf. The T-430 18-gauge stainless-steel top has two sound-deadened integrally welded 5" "C" channels to reinforce and maintain a level working surface (prevent sagging). The galvanized legs are 1-5/8" diameter and have adjustable high-impact corrosion-resistant feet. The under shelf is adjustable and has two pins per corner providing extra strength and stability. The table is National Safety Foundation certified.

Item #	Product Dimensions	List Price
6-1501833-670	36 W x 30 D x 35 H in	\$603.95
6-1501834-670	48 W x 30 D x 35 H in	\$681.95
6-1501835-670	60 W x 30 D x 35 H in	\$777.95
6-1501836-670	72 W x 30 D x 35 H in	\$855.95



**Diversified Spaces™ Hydroponics Growing Center**

Learn how plants can grow without soil and help teach the basic concepts for plant needs, nutrition, food production, recycling, agricultural technology and soilless growing environments. This mobile hydroponics center includes grow lights and water pump. The adjustable timers enable you to grow your plants with the perfect amount of water and sunlight. The construction allows easy access for students and teachers alike. The hydroponics center is made of solid maple and maple veneers. The containment plant tray is 42" W x 27-1/2" D x 8" H. There is a 25-gallon nutrient reservoir with lid, a locked cabinet for timers and air pump, and a 150 watt grow light. The growing system is completed with a submersible pump, an air pump, an air stone, two timers, hoses and ten 6" net pots. The unit moves easily on 4" locking, leveling casters. Overall dimensions: 52" W x 28" D x 78" H.

Item #	Product Dimensions	List Price
6-1510021-670	52 W x 28 D x 78 H in	\$3,511.95

**Diversified Spaces™ Augmented Reality Sandbox**

This amazing sandbox uses 3D visualization applications and a hands-on exhibit combining a real sandbox, virtual topography and water created using a closed loop of a Microsoft Kinect 3D camera, powerful simulation and visualization software, and a data projector. The resulting (AR) sandbox allows users to create topography models by shaping real sand, which is then augmented in real time by an elevation color map, topographic contour lines, and simulated water. The system teaches geographic, geologic, and hydrological concepts such as how to read a topography map, the meaning of contour lines, watersheds, catchment areas, levees, and much more. The software was designed by a team of scientists at UC-Davis. \* The sandbox comes complete with the box, camera, projector, wire management, and laptop loaded with visualization software. The sandbox is made of solid oak and oak plywood and moves on heavy-duty locking casters. A wire management system keeps the cords from interfering with box. There is a handy shelf to hold the laptop while in use, which folds away with a collapsible hinge. The 36-inch dimension measures to the top of the table. Note: sand not included (we recommend 300 pounds of Sandtastik® sparkling white play sand). Detailed instructions for calibrating the software and running the program are included. \* The Augmented Reality Sandbox was developed by the UC Davis W.M. Keck Center for Active Visualization in the Earth Sciences (KeckCAVES, www.keckcaves.org), supported by the National Science Foundation under Grant No. DRL 1114663. For more information, please visit <http://arsandbox.org>.



Example of Elevation View



Item #	Description	Product Dimensions	Color	Quantity	List Price
6-1582117-670	Augmented Reality Sandbox	48 W x 30 D x 36 H in	Oak	Each	\$17,791.49
Item #	Description	Color	Age Range	Product Weight	List Price
9-1585332-670	Therapy Play Sand	White	24+ months	25 lbs	\$38.69
9-1601030-670	Therapy Play Sand	White	24+ months	50 lbs	\$69.69



**CLASSROOM  
SELECT**



PRODUCT CERTIFIED  
FOR LOW CHEMICAL  
EMISSIONS.  
UL.COM/IGG  
UL 2818



PLEASE  
SPECIFY  
COLOR  
CHOICE

Refer to pages 60-61  
for color options.



Shown with Soft Plastic Seat

**Classroom Select® Traditional Art/Lab Stool**

Classroom Select® stools are a perfect addition to any classroom, science or technology lab. The stools feature integral chrome foot rings for extra comfort and nylon glides for easy mobility on both tile and carpet. Stool height adjusts from either 18" to 26" or 24" to 32". Seat material is available in soft or hard plastic.

Item #	Seat Height	Seat and Back Color	List Price
<b>Soft Plastic Seat</b>			
6-1388748-670	24 - 32 in	Specify	\$212.95
6-1388747-670	18 - 26 in	Specify	\$199.95
<b>Hard Plastic Seat</b>			
6-1388750-670	24 - 32 in	Specify	\$219.95
6-1388749-670	18 - 26 in	Specify	\$206.95

**Classroom Select® Pneumatic Stool**

The Classroom Select® Pneumatic Stool is a great, cost-effective option for any environment, especially in ones where space is limited. This 360 degree swivel stool features a 16" round seat cushion, in an easy to clean vinyl fabric. A durable chrome finish pneumatic lift base offers height adjustments from 17" to 22-1/2". This stool features 2" dual-wheel casters perfect for any floor surface.

Item #	Seat Height	Fabric Color	Frame Color	List Price
6-2051242-670	17 - 22-1/2 in	Black	Chrome	\$199.95



Shown with optional  
seat and back pads

**Classroom Select® Contemporary Swivel Stool**

Adjust this swivel stool from 23-1/2" to 32-1/2" in height. Features foot ring welded to the exterior of the legs for maximum stability and nylon glides for easy movement on tile and carpet. The shell is reinforced with ribs that allow greater flexibility, yet provides excellent support as you work on your projects. Ideal for lab or art room seating. Available with A or A+ extra wide shell.

Item #	Seat Height	Seat and Back Color	Fabric Color	List Price
6-1388752-670	A+ Shell	Specify	-	\$226.95
6-1388751-670	A Shell	Specify	-	\$219.95
<b>With Seat and Back Pad</b>				
6-1441250-670	A+ Shell	Specify	Specify	\$292.95
6-1441251-670	A Shell	Specify	Specify	\$286.95

**Classroom Select® NeoClass® Pneumatic Lift Stool with Adjustable Foot Ring**

The waterfall edge and ergonomic back of the polypropylene shell promote circulation and support while the top and bottom openings make mobility easy. Choose from A or A+ seat size; the A+ offers a wider, more accommodating seat. The sturdy, 5-star base has a 24" diameter, swivels 360 degrees, and features durable 2" dual casters. With an adjustable pneumatic height of 24" to 34", and a simple turn handle to adjust the 20" foot ring, this chair is comfortable at any height.

Item #	Seat Height	Seat and Back Color	List Price
6-1600895-670	A+ Shell 24 to 34 H in	Specify	\$264.95
6-1598670-670	A Shell 24 to 34 H in	Specify	\$258.95





**Diversified Spaces Tote Tray & Shelving Storage Cabinet**

A great place to store projects and larger objects for any science or art room. This unit is made up of solid oak and oak veneers with an earth-friendly, chemical resistant UV finish. The doors have three-point locking handles for secure storage. 24 tote cabinet includes one fixed and two adjustable shelves. Tray size: 14-1/4" W x 19" D x 3-1/2" H

Item #	Product Dimensions	List Price
<b>24 Tote</b>		
6-1400053-670	48 W x 22 D x 84 H in	\$3,914.95
<b>48 Tote</b>		
6-572410-670	48 W x 22 D x 84 H in	\$5,056.95



24 Tote

48 Tote



**Diversified Spaces Storage Cabinet with Doors**

Sturdy wood storage cabinet has three point locking handle and an earth friendly UV finish. Unit has six shelves, four of which are adjustable.

Item #	Product Dimensions	List Price
6-572428-670	24 W x 22 D x 84 H in	\$1,532.95
6-572425-670	36 W x 22 D x 84 H in	\$1,972.95
6-572422-670	48 W x 22 D x 84 H in	\$2,281.95

**Diversified Spaces Mobile Tote Tray Storage Cabinet**

Store various materials or student projects with these large totes in a mobile storage cabinet. Constructed of oak veneers and solid oak with a chemical resistant, earth friendly UV Finish. This unit rolls easily on 4" locking swivel casters. The two lockable doors swing 270 degrees and conceal 21 tote trays. Tote trays measure 14-1/4" W x 19" L x 3-1/2" H. Plastic laminate top can double as a work surface. Mobile capacity of 500lbs.

Item #	Product Dimensions	List Price
6-1129098-670	48 W x 24 D x 41-1/2 H in	\$3,167.95



**Diversified Spaces Mobile Microscope Storage Cabinet**

A safe, convenient way to store and share your microscopes. It is constructed of solid hardwood, solid oak and oak veneers with a chemical resistant, earth-friendly UV finish. The front and back doors have locks. The unit contains removable wire dividers to provide an individual space for each microscope. The cabinet rolls on heavy-duty swivel casters with brakes for easy movement and storage around the classroom. The top is 1-1/4" black plastic laminate and furnishes an auxiliary work surface. The cabinet has storage for 24 standard classroom microscopes.

Item #	Product Dimensions	List Price
6-676581-670	48 W x 24 D x 40-3/4 H in	\$1,848.95

**Diversified Spaces Mobile Storage Cabinet**

A compact, versatile rolling storage cabinet that is constructed of select oak and oak veneers with a chemical resistant, earth-friendly UV finish. The adjustable shelf measures 32"W x 18"D. This cabinet is equipped with four locking heavy-duty swivel casters and locking doors.

Item #	Product Dimensions	List Price
<b>Laminate Top</b>		
6-568172-670	36 W x 24 D x 36 H in	\$1,351.95
<b>ChemGuard Top</b>		
6-674393-670	36 W x 24 D x 36 H in	\$1,436.95





# makerspace

**CLASSROOM  
SELECT**



PRODUCT CERTIFIED  
FOR LOW CHEMICAL  
EMISSIONS:  
UL COMPGG  
UL 2818



projects by design®

## Classroom Select® STEAM Table

The Classroom Select® Mobile STEAM Table features four compartments, each with two adjustable shelves and locking doors. Table top is available in your choice of durable wood-grained laminate or markerboard. Table top grommet features three AC outlets, two USB ports, and an Ethernet jack. Heavy-duty 3" locking casters. Assembled.



Item #	Description	Product Dimensions	Frame Color	Top Color	Top Type	Number of Doors	Number of Stations	List Price
6-1603222-670	Laminate, 30 Inch Height	47-3/4 W x 47-3/4 D x 30 H in	Birch	Amber Maple	Laminate	4	4	\$1,666.95
6-2027838-670	Markerboard, 30 Inch Height	47-3/4 W x 47-3/4 D x 30 H in	Birch	White	Markerboard	4	4	\$1,767.95
6-1603221-670	Laminate, 25 Inch Height	47-3/4 W x 47-3/4 D x 25 H in	Birch	Amber Maple	Laminate	-	4	\$1,356.95
6-2027839-670	Markerboard, 25 Inch Height	47-3/4 W x 47-3/4 D x 25 H in	Birch	White	Markerboard	-	4	\$1,457.95



PLEASE  
SPECIFY  
COLOR  
CHOICE

Refer to pages 60-61  
for color options.

## Classroom Select® Makerspace Rectangle Activity Table

Constructed with a galvanized steel stretcher bar that permanently attaches to the underside of the top for extra stability, this 60" W x 30" D table is perfect for a collaborative working environment. Designed with a premium elliptical leg, the table features adjustable heights in ranges 15" to 25", 22" to 30", and 30" to 43". LockEdge® activity tables are made of 1-1/8" MDF core with a high pressure laminate top. T-Mold activity tables are made of 1-1/8" particleboard with high pressure laminate top. Casters available.

**Quickship available in Bannister Oak, Gray Nebula, Fusion Maple, Nepal Teak, Royal Blue or Markerboard laminate, with Black or Titanium T-Mold edge or Black LockEdge in your choice of any leg height and color.**

Item #	Top Shape	Product Height	Top Type	Top Color	Edge Color	Leg Color	List Price
<b>T-Mold</b>							
6-1598329-670	Rectangle	Specify	Laminate	Specify	Specify	Specify	\$359.95
6-1598383-670	Rectangle	Specify	Markerboard	White	Specify	Specify	\$399.95
<b>LockEdge®</b>							
6-1598356-670	Rectangle	Specify	Laminate	Specify	Specify	Specify	\$459.95
6-1598410-670	Rectangle	Specify	Markerboard	White	Specify	Specify	\$499.95

Item #	Description	List Price
<b>Elliptical Leg Caster Inserts (Sets of 2)</b>		
6-1609060-670	Caster Inserts for 22-30" Leg	\$59.95
6-5002713-670	Caster Inserts for 30-43" Leg	\$119.95

**24-hr Quickship** available for item 1598329 with Gray Nebula or Bannister Oak Top and Black T-mold edge, in your choice of any leg height and color. Quantities not to exceed 10 each. Applies to orders containing 24 hr quickship items only.



**CLASSROOM  
SELECT** 



PRODUCT CERTIFIED  
FOR LOW CHEMICAL  
EMISSIONS  
UL.COM/GG  
UL 2818



Refer to pages 60-61  
for color options.



Additional shapes  
available online

**Classroom Select® Vigor® Utility Table**

This versatile heavy-duty utility table is perfect for project learning environments; especially in STEAM/STEM, Art, Science, and Robotic classrooms. Tables with T-Mold edge band are made of 1-1/8" particleboard core. Tables with LockEdge® feature a sprayed on polyurethane edge on a 1-1/8" MDF top, providing increased durability. Durable butcher block tops are made of 1-1/2" finished, solid wood butcher block. Sealed with a polyurethane coating, making this top a perfect addition to our most heavy-duty Vigor® Utility Table. Choose from 14-gauge 2" square legs or 2" round legs both adjustable from 29" to 42" in height. The durable unitized frame is black powder coat with a solid steel apron providing the ultimate strength and support for any project.

Top Shape	Product Dimensions	Edge Color	Leg Style	Laminate Top			Markerboard Top	
				Item #	Top Color	List Price	Item #	List Price
<b>T-Mold</b>								
Rectangle	48 W x 24 D in	Specify	Specify	6-5003664-670	Specify	\$599.95	6-5003652-670	\$646.95
Rectangle	60 W x 24 D in	Specify	Specify	6-5003665-670	Specify	\$612.95	6-5003699-670	\$659.95
Rectangle	60 W x 30 D in	Specify	Specify	6-5003671-670	Specify	\$626.95	6-5003662-670	\$672.95
Rectangle	72 W x 30 D in	Specify	Specify	6-5003709-670	Specify	\$639.95	6-5003701-670	\$686.95
Round	36 in	Specify	Specify	6-5003690-670	Specify	\$612.95	6-5003718-670	\$659.95
Round	42 in	Specify	Specify	6-5003689-670	Specify	\$626.95	6-5003681-670	\$672.95
Round	48 in	Specify	Specify	6-5003723-670	Specify	\$639.95	6-5003658-670	\$686.95
Round	60 in	Specify	Specify	6-5003670-670	Specify	\$666.95	6-5003726-670	\$712.95
Square	36 in	Specify	Specify	6-5003703-670	Specify	\$612.95	6-5003696-670	\$659.95
Square	42 in	Specify	Specify	6-5003669-670	Specify	\$626.95	6-5003725-670	\$672.95
Square	48 in	Specify	Specify	6-5003697-670	Specify	\$639.95	6-5003719-670	\$686.95
Kidney	72 W x 48 D in	Specify	Specify	6-5003676-670	Specify	\$866.95	6-5003663-670	\$912.95
Kidney	96 W x 48 D in	Specify	Specify	6-5003657-670	Specify	\$932.95	6-5003644-670	\$979.95
Horseshoe	72 W x 48 D in	Specify	Specify	6-5003650-670	Specify	\$866.95	6-5003668-670	\$912.95
Horseshoe	66 W x 60 D in	Specify	Specify	6-5003647-670	Specify	\$932.95	6-5003649-670	\$979.95
Clover	48 W x 48 D in	Specify	Specify	6-5003707-670	Specify	\$639.95	6-5003654-670	\$686.95
<b>LockEdge®</b>								
Rectangle	48 W x 24 D in	Specify	Specify	6-5003684-670	Specify	\$666.95	6-5003721-670	\$712.95
Rectangle	60 W x 24 D in	Specify	Specify	6-5003660-670	Specify	\$679.95	6-5003704-670	\$726.95
Rectangle	60 W x 30 D in	Specify	Specify	6-5003667-670	Specify	\$692.95	6-5003714-670	\$739.95
Rectangle	72 W x 30 D in	Specify	Specify	6-5003705-670	Specify	\$706.95	6-5003692-670	\$752.95
Round	36 in	Specify	Specify	6-5003708-670	Specify	\$679.95	6-5003716-670	\$726.95
Round	42 in	Specify	Specify	6-5003694-670	Specify	\$692.95	6-5003715-670	\$739.95
Round	48 in	Specify	Specify	6-5003713-670	Specify	\$706.95	6-5003711-670	\$752.95
Round	60 in	Specify	Specify	6-5003691-670	Specify	\$732.95	6-5003675-670	\$779.95
Square	36 in	Specify	Specify	6-5003698-670	Specify	\$679.95	6-5003720-670	\$726.95
Square	42 in	Specify	Specify	6-5003643-670	Specify	\$692.95	6-5003680-670	\$739.95
Square	48 in	Specify	Specify	6-5003666-670	Specify	\$706.95	6-5003712-670	\$752.95
Kidney	72 W x 48 D in	Specify	Specify	6-5003679-670	Specify	\$932.95	6-5003648-670	\$979.95
Kidney	96 W x 48 D in	Specify	Specify	6-5003645-670	Specify	\$999.95	6-5003687-670	\$1,046.95
Horseshoe	72 W x 48 D in	Specify	Specify	6-5003653-670	Specify	\$932.95	6-5003677-670	\$979.95
Horseshoe	66 W x 60 D in	Specify	Specify	6-5003651-670	Specify	\$999.95	6-5003686-670	\$1,046.95
Clover	48 W x 48 D in	Specify	Specify	6-5003642-670	Specify	\$706.95	6-5003659-670	\$752.95

Top Shape	Product Dimensions	Leg Style	Butcherblock Top	
			Item #	List Price
Rectangle	48 W x 24 D in	Specify	6-5004645-670	\$932.95
Rectangle	60 W x 24 D in	Specify	6-5004639-670	\$946.95
Rectangle	48 W x 30 D in	Specify	6-5004644-670	\$946.95
Rectangle	60 W x 30 D in	Specify	6-5004640-670	\$959.95
Rectangle	72 W x 30 D in	Specify	6-5004641-670	\$972.95
Rectangle	60 W x 36 D in	Specify	6-5004642-670	\$972.95
Square	42 in	Specify	6-5004643-670	\$959.95





Refer to pages 60-61 for color options.

### Classroom Select® Construct-IT® Makerspace Utility Project Center

The perfect companion to the Geode Series® storage cabinets, the Construct-IT® is built like a rock with a durable steel frame and side panels available in 11 vibrant color options to make any room shine. Super heavy-duty, 4-inch zinc alloy casters, 2 locking and 2 non-locking, provide smooth and reliable transportation. Side panels feature rows of peg board perforation for increased storage potential. **Durable steel shelving units can be purchased as an accessory for added storage space.** Table tops are offered in a variety of sizes to fit any of your work area needs as well as laminate, markerboard, and butcher block options. Our uniquely engineered frames are height adjustable from 29" to 42" in 1" increments allowing you to choose a sitting or standing worksurface.

Item #	Product Dimensions	Top Type	Top Color	Edge Color	Panel Color	List Price
<b>Laminate with T-Mold</b>						
6-5004240-670	42 in	Laminate	Specify	Specify	Specify	\$892.95
6-5004243-670	48W x 30D in	Laminate	Specify	Specify	Specify	\$866.95
6-5004241-670	60W x 30D in	Laminate	Specify	Specify	Specify	\$919.95
6-5004242-670	72W x 30D in	Laminate	Specify	Specify	Specify	\$946.95
6-5004244-670	60W x 36D in	Laminate	Specify	Specify	Specify	\$946.95
6-5004245-670	72W x 36D in	Laminate	Specify	Specify	Specify	\$972.95
<b>Laminate with LockEdge®</b>						
6-5004246-670	42 in	Laminate	Specify	Specify	Specify	\$959.95
6-5004249-670	48W x 30D in	Laminate	Specify	Specify	Specify	\$932.95
6-5004247-670	60W x 30D in	Laminate	Specify	Specify	Specify	\$986.95
6-5004248-670	72W x 30D in	Laminate	Specify	Specify	Specify	\$1,012.95
6-5004250-670	60W x 36D in	Laminate	Specify	Specify	Specify	\$1,012.95
6-5004251-670	72W x 36D in	Laminate	Specify	Specify	Specify	\$1,039.95
<b>Markerboard with T-Mold</b>						
6-5004252-670	42 in	Markerboard	White	Specify	Specify	\$939.95
6-5004255-670	48W x 30D in	Markerboard	White	Specify	Specify	\$912.95
6-5004253-670	60W x 30D in	Markerboard	White	Specify	Specify	\$966.95
6-5004254-670	72W x 30D in	Markerboard	White	Specify	Specify	\$992.95
6-5004256-670	60W x 36D in	Markerboard	White	Specify	Specify	\$992.95
6-5004257-670	72W x 36D in	Markerboard	White	Specify	Specify	\$1,019.95
<b>Markerboard with LockEdge®</b>						
6-5004258-670	42 in	Markerboard	White	Specify	Specify	\$1,006.95
6-5004261-670	48W x 30D in	Markerboard	White	Specify	Specify	\$979.95
6-5004259-670	60W x 30D in	Markerboard	White	Specify	Specify	\$1,032.95
6-5004260-670	72W x 30D in	Markerboard	White	Specify	Specify	\$1,059.95
6-5004262-670	60W x 36D in	Markerboard	White	Specify	Specify	\$1,059.95
6-5004263-670	72W x 36D in	Markerboard	White	Specify	Specify	\$1,086.95
<b>Butcher Block</b>						
6-5004264-670	42 in	Butcher Block	-	-	Specify	\$1,226.95
6-5004267-670	48W x 30D in	Butcher Block	-	-	Specify	\$1,199.95
6-5004265-670	60W x 30D in	Butcher Block	-	-	Specify	\$1,252.95
6-5004266-670	72W x 30D in	Butcher Block	-	-	Specify	\$1,279.95
6-5004268-670	60W x 36D in	Butcher Block	-	-	Specify	\$1,279.95
6-5004269-670	72W x 36D in	Butcher Block	-	-	Specify	\$1,306.95

Item #	Product Dimensions	List Price
<b>Top Shelf for Smaller Frame (42 in and 48 in wide)</b>		
9-2051364-670	34 W x 18 D in	\$79.95
<b>Bottom Shelf for Smaller Frame (42 in and 48 in wide)</b>		
9-2051363-670	34 W x 22-1/2 D in	\$92.95
<b>Top Shelf for Larger Frame (60 in and 72 in wide)</b>		
9-2051210-670	52 W x 18 D in	\$119.95
<b>Bottom Shelf for Larger Frame (60 in and 72 in wide)</b>		
9-2051211-670	52 W x 22-1/2 D in	\$132.95

### Classroom Select® Project Bumper Frame

The Classroom Select® Project Bumper Frame is a perfect addition to your makerspace activities or any projects-based learning environment. Corner connector pieces are molded from a durable ABS material and side clamps are made of strong 12-gauge steel. Side panels are constructed with 1-1/8 inch MDF core double-sided with high pressure laminate and finished off with black 3mm edge banding. Designed specifically for simple assembly with easy slide-in board guides and corner connector pieces secured with inset screws. The Project Bumper Frame easily mounts on the top of our most popular rectangle activity table sizes, including our Vigor® and Construct-IT®, and our butcher block table tops. Project Bumper Frame can also be used as a floor robotic boundary area. Available in five easy to coordinate laminate colors: Gray Nebula, Dove Gray, Black, Royal Blue, and Red with black 3mm edge band. Project Bumper Frame set includes 4 corner ABS connectors, 2 side clamps, 4 high pressure laminate sideboards, and hardware.

Table sold separately.

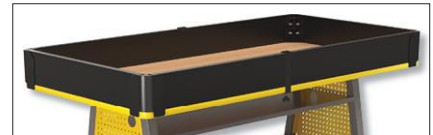

Item #	Product Dimensions	Edge Color	Panel Color	List Price
6-5008777-670	42 W x 42 D x 6 H in	Black	Specify	\$353.95
6-5008775-670	48 W x 24 D x 6 H in	Black	Specify	\$335.95
6-5008780-670	72 W x 24 D x 6 H in	Black	Specify	\$372.95
6-5008779-670	48 W x 30 D x 6 H in	Black	Specify	\$352.95
6-5008769-670	60 W x 30 D x 6 H in	Black	Specify	\$375.95
6-5008770-670	72 W x 30 D x 6 H in	Black	Specify	\$402.95
6-5008768-670	60 W x 36 D x 6 H in	Black	Specify	\$388.95
6-5008772-670	72 W x 36 D x 6 H in	Black	Specify	\$415.95



Rectangle Laminate T-Mold



Square Laminate LockEdge with Shelves



Rectangle Markerboard T-Mold



Rectangle Butcher Block with Shelves



PRODUCT CERTIFIED FOR LOW CHEMICAL EMISSIONS: UL.COM/IGG UL 2818



**Diversified Spaces™ 2 and 4 Station Bench**

The base of the unit is constructed of solid maple and maple veneers. The 2-1/4" thick top is hard maple. The unit is finished with an Earth-friendly UV finish. The locking doors have pulls and are hung on five knuckle institutional hinges while the locking drawers are fully dovetailed and roll easily on epoxy coated glides. Units can be ordered with or without vises. Choose between two-station and four-station units. Overall size: 64"W x 28"D x 31-1/4"H for the two-station and 64"W x 54"D x 31-1/4"H for the four-station.

Item #	Description	Product Dimensions	Color	Number of Doors	Number of Drawers	List Price
<b>Two Person Units - No Vises</b>						
6-526473-670	2 Station, with No Vises	64 W x 28 D x 31-1/4 H in	Maple	2	-	\$2,582.95
6-526475-670	2 Station, with No Vises	64 W x 28 D x 31-1/4 H in	Maple	2	2	\$3,079.95
<b>Two Person Units - Two Vises</b>						
6-526474-670	2 Station, with 2 Vises	64 W x 28 D x 31-1/4 H in	Maple	2	-	\$3,918.95
<b>Four Person Units - No Vises</b>						
6-526467-670	4 Station, with No Vises	64 W x 54 D x 31-1/4 H in	Maple	4	-	\$5,151.95
6-526469-670	4 Station, with No Vises	64 W x 54 D x 31-1/4 H in	Maple	4	4	\$5,909.95
6-526465-670	4 Station, with No Vises	64 W x 54 D x 31-1/4 H in	Maple	12	-	\$6,508.95
<b>Four Person Units - Four Vises</b>						
6-526468-670	4 Station, with 4 Vises	64 W x 54 D x 31-1/4 H in	Maple	4	-	\$7,591.95
6-526470-670	4 Station, with 4 Vises	64 W x 54 D x 31-1/4 H in	Maple	4	4	\$8,259.95
6-526466-670	4 Station, with 4 Vises	64 W x 54 D x 31-1/4 H in	Maple	12	-	\$8,818.95



PLEASE SPECIFY COLOR CHOICE

**Montisa 4 Station Bench**

Tough four station workbenches offer a range of options for educational environments. These hard-working benches are built to last, with solid base units supporting a hard maple surface. Available with vises. Base units are 36" W x 42" D x 31" H. Tops are 64" W x 54" D x 2 1/4" H. Each bench has an overall height of 33-1/4". 100-year warranty on all steel parts. **Please specify base color when ordering.**

Item #	Description	Product Dimensions	Color	Number of Bases	Number of Doors	Number of Drawers	List Price
<b>Four Person Unit - No Vises</b>							
6-1509942-670	Workbench w/Doors, No Vise	64 W x 54 D x 33-1/4 H in	Specify	2	4	-	\$4,990.95
6-1509940-670	Workbench w/Drawers, No Vises	64 W x 54 D x 33-1/4 H in	Specify	2	4	4	\$6,320.95
6-1509938-670	Workbench w/Lockers, No Vises	64 W x 54 D x 33-1/4 H in	Specify	2	8	-	\$5,249.95
6-1509936-670	Workbench w/Horiz Lockers	64 W x 54 D x 33-1/4 H in	Specify	2	12	-	\$5,045.95
6-1509934-670	Workbench w/Vert Lockers	64 W x 54 D x 33-1/4 H in	Specify	2	12	-	\$5,776.95
<b>Four Person Unit - Four Vises</b>							
6-1509941-670	Workbench w/Doors, 4 Vises	64 W x 54 D x 33-1/4 H in	Specify	2	4	-	\$6,801.95
6-1509939-670	Workbench w/Drawers, 4 Vises	64 W x 54 D x 33-1/4 H in	Specify	2	4	4	\$8,130.95
6-1509937-670	Workbench w/Lockers, 4 Vises	64 W x 54 D x 33-1/4 H in	Specify	2	8	-	\$7,433.95
6-1509935-670	Workbench HorizLockers,4Vises	64 W x 54 D x 33-1/4 H in	Specify	2	12	-	\$6,993.95
6-1509933-670	Workbench Vert Lockers,4Vises	64 W x 54 D x 33-1/4 H in	Specify	2	12	-	\$7,586.95

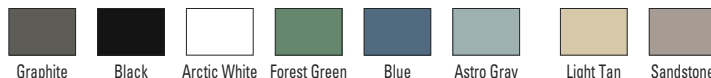





CLASSROOM  
**SELECT**



### Classroom Select® Pneumatic Stool

The Classroom Select® Pneumatic Stool is a great, cost-effective option for any environment, especially in ones where space is limited. This 360-degree swivel stool features a 16" round seat cushion, in an easy to clean vinyl fabric. A durable chrome finish pneumatic lift base offers height adjustments from 17" to 22-1/2". This stool features 2" dual-wheel casters perfect for any floor surface.

Item #	Seat Height	Fabric Color	Frame Color	List Price
6-2051242-670	17 - 22-1/2 in	Black	Chrome	\$199.95



### Montisa® Elton Angle Leg Stool

The Elton line of angle-leg stools are built to last. Constructed of four 7/8" x 7/8" x 1/8" steel legs welded into a solid frame with ball feet and nylon disk glides, and topped by a sturdy seat. Available in a variety of heights ranging from 16" to 30" high. The 14" diameter "dished" seat design adds additional comfort. Rungs on all four sides mean there is no wrong way to sit. Available in a steel or wood seat.

Item #	Seat Height	Frame Color	List Price
<b>Steel Seat</b>			
6-1478603-670	16 in	Specify	\$250.95
6-1478604-670	18 in	Specify	\$252.95
6-1478605-670	20 in	Specify	\$255.95
6-1478606-670	22 in	Specify	\$257.95
6-1478607-670	24 in	Specify	\$265.95
6-1478608-670	26 in	Specify	\$302.95
6-1478609-670	28 in	Specify	\$302.95
6-1478610-670	30 in	Specify	\$311.95
<b>Wood Seat</b>			
6-1478595-670	16 in	Specify	\$372.95
6-1478596-670	18 in	Specify	\$375.95
6-1478597-670	20 in	Specify	\$376.95
6-1478598-670	22 in	Specify	\$380.95
6-1478599-670	24 in	Specify	\$388.95
6-1478600-670	26 in	Specify	\$426.95
6-1478601-670	28 in	Specify	\$428.95
6-1478602-670	30 in	Specify	\$435.95

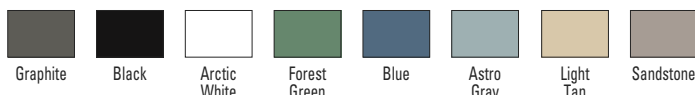

Diversified Spaces™ Stool Colors



### Diversified Spaces™ Tractor Stools

Stand out with the Diversified Spaces™ Tractor Stool that combines form and function. These ergonomic stools are constructed from rugged polyurethane that is self-skinning, chemical- and puncture-resistant, and fully washable. They easily adjust in height with a smooth pneumatic circle adjustment. They come standard with black non-marring glides, but optional self-braking, non-locking casters are available with a weight capacity of 300 lbs. All backed by a 15-year warranty—lifetime on the pneumatic lift. Comes in your choice of 18"-23" adjustable desk height or 21"-28" standing height. Choose either a blue or black seat color.

Item #	Seat Height	Frame Color	List Price
5-5004076-670	18 to 23 Inches	Black	\$462.95
5-5004077-670	21 to 28 Inches	Black	\$615.95

Item #	Description	List Price
5-2038144-670	Tractor Stool Casters	\$139.95



CLASSROOM  
SELECT



**Classroom Select® Mobile Compartment Storage**

Classroom Select® mobile storage unit provides generous storage space with six extra large cubby shelving areas. Made of solid birch, the unit has fixed shelving with each cubby sized 22" W x 21" D x 19" H. Doors are locking and the unit includes four 4" extra- durable locking casters.

Item #	Description	Product Dimensions	Number of Adjustable Shelves	Number of Fixed Shelves	Color	List Price
6-2004420-670	Fixed Shelf Storage	48 W x 24 D x 67 H in	0	4	Natural	\$1,768.95



**Classroom Select® Robotic Adjustable Shelf Storage**

Classroom Select® mobile adjustable storage unit provides premium storage capacity. Made of solid birch, the unit is designed to offer flexible capacity. One side stores your robotic or makerspace projects on drawers with full extension glides that allow students to easily pull their projects out with careful movement while the other side of the cabinet has adjustable shelves for convenient positioning and storage of trays, components, tools, supplies and projects. Doors are locking and the unit includes four 4" extra durable locking casters.

Item #	Description	Product Dimensions	Number of Drawers	Color	List Price
6-2004421-670	Adjustable Shelf Storage	48 W x 24 D x 67 H in	3	Natural	\$2,058.95

**Classroom Select® Robotic Workbench**

Classroom Select® mobile workbench provides both storage and work surface space to make the most of your makerspace and robotic project area. Made of solid birch and featuring easy pull out lower shelves to carefully store and remove those delicate projects. Organize components, supplies or tools with two spacious upper closed drawers. The top expands an additional 12-1/4" to a full 36" depth work surface, perfect for those extra-large projects. Each cubby offers a generously-sized capacity of 21" W x 18" D x 23" H. Locking doors offers security and peace of mind to keep projects safe and secure. The unit includes locking 4" extra durable casters for ease of movement.



Top can expand for 36" work surface



Item #	Description	Product Dimensions	Color	List Price
6-2004422-670	Mobile Workbench	48 W x 24 D x 36 H in	Natural	\$1,983.95



**Classroom Select® Mobile Tool Storage**

Classroom Select® Mobile Tool Storage unit provides generous and organized storage capacity. Made of solid birch, the unit is designed to offer flexible capacity. Both interior sides and interior back of the upper half is pegboard to hold and organize all your tools. The unit also holds trays to store the smallest of components with easy take-off and snap-on ability. Four easy-glide drawers help to organize or store any project related materials or supplies. Doors are locking and the unit includes four 4" extra durable locking casters.

Item #	Product Dimensions	Number of Drawers	List Price
6-2004423-670	51 W x 24 D x 67 H in	4	\$2,338.95



CLASSROOM  
SELECT 



A



B



C



D



E

### Classroom Select® Makerspace Mobile Carts

Classroom Select® Makerspace Mobile Carts are flexible, functional and help students organize their projects. Cabinet tops are made of 1-1/2" finished solid wood butcher block. Interior adjustable shelves are perfect for ease of storage. Back panels are made of magnetic painted steel markerboard for quick project notes and illustrations. Both sides of all carts are constructed of steel peg board durable enough to hang supplies and tools. A pack of ten pegs for ready to use hanging storage is included for each cart. All carts include a large titanium-color polypropylene handle for ease of mobility. Two of the four casters lock providing secure positioning. Carts include locking doors, ideal for project safety. The tool storage cart has peg board sides, two pass-through shelves, bottom shelves that hold component or smaller tool storage and smooth mobility and locking casters allowing students to safely share and store tools while collaborating and learning. The 3D printer cart includes a 18-1/2" x 18-1/2" removable tray for extra work surface space. Assembled.

	Item #	Description	Product Dimensions	Color	List Price
A	6-2010424-670	Small Makerspace Cart	24-1/2 W x 25-1/2 D x 40 H in	Black	\$965.95
B	6-2010426-670	Medium Makerspace Cart	32-1/2 W x 25-1/2 D x 40 H in	Black	\$1,098.95
C	6-2010427-670	Large Makerspace Cart	51-1/4 W x 25-1/2 D x 40 H in	Black	\$1,414.95
D	6-2010425-670	3D Printer Cart	33-1/2 W x 25-1/2 D x 40 H in	Black	\$1,085.95
E	6-2010428-670	Tool Storage Cart	39-1/2 W x 19 D x 40 H in	Black	\$955.95





PLEASE SPECIFY COLOR CHOICE  
Refer to page 253 for color options.



Accessories found on page 256

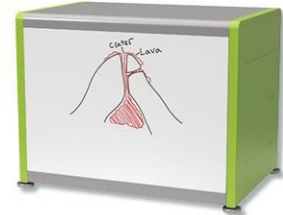

Double Wide Open with 1 Shelf and Markerboard Back - Short



Double Wide Open with 16 3/4 Totes - Medium



Double Wide with Doors and 12-6 Totes - Tall

Classroom Select® Geode Series® Storage - Double Wide - 36"

An engaging learning environment needs compelling teaching materials. Store your classroom needs in confidence with the Classroom Select® Geode Series®. Built like a rock with a durable 18-gauge steel frame and side panels available in 11 vibrant color options to make any room shine. Super heavy duty 4-inch zinc alloy locking casters provide smooth and reliable transportation. Select locking doors for added protection, because with the Classroom Select® Geode Series®, it's about what's on the inside. All units are shipped fully assembled and are crafted in the USA with globally sourced materials. Choose from short, medium and tall height in single, double or triple wide versions. Accessories compatible with short and medium sizes only. Push handles are available in single solid color only. Additional features include:

- Sliding tote trays, available in options of 3", 6", or 12" tall totes that are compatible with Classroom Select® desks Concord and Advocate Series®.
- Side panels feature rows of peg board perforations for increased storage potential.
- Durable steel shelving adjustable in 1" increments to fit your storage space needs. Combine shelves and totes on select units for a more adaptable solution.

Standard Back

Markerboard Back

Description	Number of Totes	Side Panel Color	With Glides		With Casters		With Glides		With Casters	
			Item #	List Price	Item #	List Price	Item #	List Price	Item #	List Price
<b>Short</b>										
Open w/ 1 shelf	–	Specify	6-5003343-670	\$955.95	6-5003531-670	\$1,062.95	6-5003319-670	\$1,064.95	6-5003475-670	\$1,172.95
Door w/ 1 shelf	–	Specify	6-5003421-670	\$1,181.95	6-5003455-670	\$1,288.95	6-5003318-670	\$1,290.95	6-5003495-670	\$1,398.95
Open w/ 10-3" totes	10	Specify	6-5003307-670	\$1,197.95	6-5003528-670	\$1,305.95	6-5003305-670	\$1,307.95	6-5003459-670	\$1,415.95
Door w/ 10-3" totes	10	Specify	6-5003322-670	\$1,424.95	6-5003490-670	\$1,531.95	6-5003304-670	\$1,533.95	6-5003548-670	\$1,641.95
Open w/ 6-3" totes and 2-6" totes	8	Specify	6-5003328-670	\$1,153.95	6-5003550-670	\$1,261.95	6-5003312-670	\$1,263.95	6-5003485-670	\$1,371.95
Door w/ 6-3" totes and 2-6" totes	8	Specify	6-5003302-670	\$1,379.95	6-5003491-670	\$1,487.95	6-5003306-670	\$1,489.95	6-5003499-670	\$1,597.95
<b>Medium</b>										
Open w/ 2 shelves	–	Specify	6-5003432-670	\$1,195.95	6-5003558-670	\$1,303.95	6-5003339-670	\$1,342.95	6-5003551-670	\$1,450.95
Door w/ 2 shelves	–	Specify	6-5003413-670	\$1,494.95	6-5003597-670	\$1,602.95	6-5003355-670	\$1,641.95	6-5003482-670	\$1,749.95
Open w/ 16-3/4" totes	16	Specify	6-5003433-670	\$1,525.95	6-5003535-670	\$1,633.95	6-5003390-670	\$1,672.95	6-5003538-670	\$1,780.95
Door w/ 16-3/4" totes	16	Specify	6-5003367-670	\$1,823.95	6-5003514-670	\$1,931.95	6-5003424-670	\$1,971.95	6-5003478-670	\$2,078.95
Open w/ 8-3" totes and 4-6" totes	12	Specify	6-5003392-670	\$1,447.95	6-5003568-670	\$1,554.95	6-5003434-670	\$1,594.95	6-5003543-670	\$1,702.95
Door w/ 8-3" totes and 4-6" totes	12	Specify	6-5003416-670	\$1,746.95	6-5003509-670	\$1,853.95	6-5003340-670	\$1,892.95	6-5003483-670	\$2,000.95
Open w/ 8-6" totes	8	Specify	6-5003427-670	\$1,376.95	6-5003545-670	\$1,484.95	6-5003354-670	\$1,523.95	6-5003500-670	\$1,631.95
Door w/ 8-6" totes	8	Specify	6-5003303-670	\$1,675.95	6-5003463-670	\$1,783.95	6-5003395-670	\$1,822.95	6-5003554-670	\$1,930.95
<b>Tall</b>										
Open w/ 3 shelves	–	Specify	6-5003450-670	\$1,509.95	6-5003571-670	\$1,616.95	6-5003440-670	\$1,657.95	6-5003525-670	\$1,765.95
Door w/ 3 shelves	–	Specify	6-5003375-670	\$1,905.95	6-5003516-670	\$2,013.95	6-5003372-670	\$2,054.95	6-5003487-670	\$2,162.95
Open w/ 24-3" totes	24	Specify	6-5003412-670	\$1,983.95	6-5003579-670	\$2,091.95	6-5003359-670	\$2,131.95	6-5003567-670	\$2,239.95
Door w/ 24-3" totes	24	Specify	6-5003345-670	\$2,380.95	6-5003480-670	\$2,487.95	6-5003437-670	\$2,528.95	6-5003524-670	\$2,636.95
Open w/ 6-3" totes and 2-12" totes	14	Specify	6-5003402-670	\$1,819.95	6-5003573-670	\$1,927.95	6-5003400-670	\$1,967.95	6-5003517-670	\$2,075.95
Door w/ 6-3" totes and 2-12" totes	14	Specify	6-5003360-670	\$2,216.95	6-5003532-670	\$2,324.95	6-5003431-670	\$2,364.95	6-5003521-670	\$2,472.95
Open w/ 12-6" totes	12	Specify	6-5003438-670	\$1,766.95	6-5003476-670	\$1,874.95	6-5003362-670	\$1,915.95	6-5003582-670	\$2,022.95
Door w/ 12-6" totes	12	Specify	6-5003347-670	\$2,163.95	6-5003515-670	\$2,271.95	6-5003420-670	\$2,311.95	6-5003508-670	\$2,419.95





### Gratnells MakerSpace Trolley

The Gratnells MakerSpace Trolley holds standard Gratnells trays on StopSafe runners, allowing easy and safe access to components. Side and back panels include industry standard peg holes and slots for wide range of accessories. Comes complete with three deep (F2) trays, 12 shallow (F1) trays, 12 mini bins (only available in green), roll holder, 5 single hooks and 5 double hooks. Heavy-duty lockable caster also included.



### Gratnells MakerHub Trolley

The Gratnells MakerHub Trolley is a multi-functional resource trolley that promotes collaborative working in STEAM activities in the classroom. Magnetic whiteboards are instantly interchangeable – simply lift up and draw down to remove. All standard boards are held safely in place between steel guides at the top of the frame and special stoppers on the recessed shelf. Four deep (F2) trays are included and can face either direction. Heavy-duty lockable casters also included.



Item #	Description	Product Dimensions	Tray Colors	List Price
6-5003171-670	MakerSpace Trolley	40 W x 17 D x 62 H in	Specify	\$2,618.95

Item #	Description	Product Dimensions	Tray Colors	List Price
6-5003170-670	Makerhub Trolley	17 W x 27 D x 56 H in	Specify	\$1,846.95



### Gratnells Rover Carts

Tough and practical, the Gratnells Rover has been designed to carry trays over any terrain and help you move heavy loads around with ease. Whether you need to take beanbags and bottled water to the field on sports day or a class full of iPads to an after-school club, the Rover is ideal for transporting anything you need, even up and down stairs. Trays and a strap to secure are included.

Item #	Description	Product Dimensions	Number of Trays	Tray Colors	List Price
A 6-5003158-670	Rover Cart w/ F2 Trays	22 W x 16-4/5 D x 46 H in	3	Specify	\$1,220.95
B 6-5003161-670	Rover Cart w/ F25 Trays	22 W x 16-4/5 D x 46 H in	3	Specify	\$1,285.95
C 6-5003146-670	Rover Cart w/ F3 Trays	22 W x 16-4/5 D x 46 H in	2	Specify	\$1,321.95



### Gratnells Callero Plus Storage

Callero Plus is an ergonomically designed storage solution featuring enclosed metal framing, which reduces the need for cleaning as well as offering enhanced security. The trolleys are available in two size variations, double and triple, and are all supplied fully assembled in a durable white finish. Each unit is fitted with StopSafe runners, includes feet and locking casters.

Item #	Description	Product Dimensions	Number of Trays	Tray Colors	List Price
A 6-5003156-670	Double Cart w/ 16 Trays	27-1/5 W x 17 D x 41-1/2 H in	16	Specify	\$1,675.95
6-5003175-670	Double Cart w/ 12 Trays	27-1/5 W x 17 D x 41-1/2 H in	12	Specify	\$1,607.95
6-5003153-670	Double Cart w/ 4 Trays	27-1/5 W x 17 D x 41-1/2 H in	4	Specify	\$1,429.95
B 6-5003148-670	Double Cart w/ 8 Trays	27-1/5 W x 17 D x 41-1/2 H in	8	Specify	\$1,623.95
6-5003150-670	Triple Cart w/ 6 Trays	40-1/5 W x 17 D x 41-1/2 H in	6	Specify	\$1,573.95
C 6-5003168-670	Triple Cart w/ 9 Trays	40-1/5 W x 17 D x 41-1/2 H in	9	Specify	\$1,772.95
6-5003166-670	Triple Cart w/ 12 Trays	40-1/5 W x 17 D x 41-1/2 H in	12	Specify	\$1,857.95
6-5003169-670	Triple Cart w/ 16 Trays	40-1/5 W x 17 D x 41-1/2 H in	16	Specify	\$2,038.95
D 6-5003173-670	Triple Cart w/ 24 Trays	40-1/5 W x 17 D x 41-1/2 H in	24	Specify	\$2,129.95
E 6-5003143-670	Triple Cart w/ 6 Large Trays	40-1/5 W x 17 D x 41-1/2 H in	6	Specify	\$1,685.95

### Gratnells Tray Colors





# educational technology

## CLASSROOM SELECT



### Classroom Select® 3D Printer Cart

Classroom Select® 3D printer cart offers the best organization yet for your makerspace projects including adjustable enclosed shelves, filament spool storage, and a side shelf that can be in-use, folded down, or detached altogether. The side shelf measures 18 W x 18D. Comes with a backside panel that is magnetic markerboard made of 28-gauge painted steel. Door locks for extra security. On one side there is a large Titanium color polypropylene handle for easy push or pull movement. Cabinet includes two casters that are locking and two casters that are non-locking for smooth mobility and proper positioning when needed.

Item #	Description	Product Dimensions	Color	List Price
6-2010425-670	3D Printer Cart	33-1/2" W x 25-1/2" D x 40" H in	Black	\$1,085.95

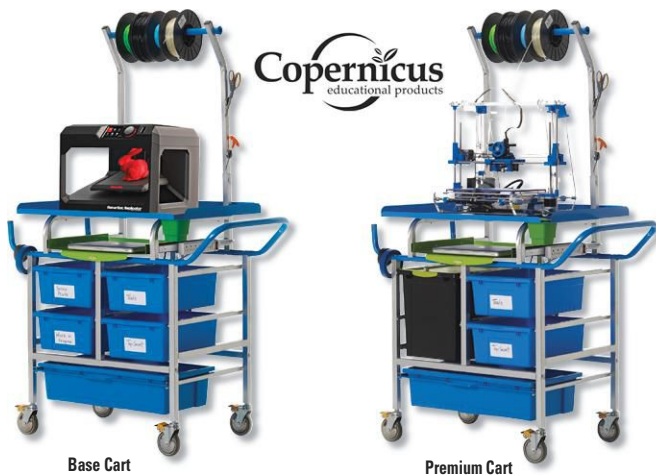

**Copernicus**  
educational products

Base Cart

Premium Cart

### Copernicus 3D Printer Cart

As schools begin to explore the exciting capabilities of 3D Printing, the need to properly store the tools and materials required increases. This 3D Printer Cart allows printing equipment to be shared around the school easily and keeps everything that you need close at hand. Features adjustable spool holder (max 4 spools), tool storage, sliding laptop shelf (fits laptops up to 17"), magnets for attaching accessories to frame, 4" casters, 2 locking and 6 outlet power strip. Accommodates 3D printers with a footprint of up to 24"D x 26-1/2"W.

**Base Model includes 4 Open Tubs, 1 Large Tub.**

**Premium Model includes Base Tech Tub™, 2 Open Tubs, 1 Large Tub.**

Frame Dimensions: 41"W x 24"D x 59"H

Lifetime Tech Tub™ and Lid Warranty; 5 Year Frame Warranty; Lifetime Tub Warranty.

Item #	Description	Product Dimensions	Color	List Price
6-1498248-670	3D Printer Cart - Base	41 W x 24 D x 59 H in	Silver/Blue	\$790.95
6-1531318-670	3D Printer Cart - Premium	41 W x 24 D x 59 H in	Silver/Blue	\$851.95





**Robo™ E3 3D Printer Plus Curriculum Bundle**

- Deliver STEM education in an interactive and engaging manner, using 3D printing to create manipulatives for over 250 hands on STEM projects for K12 students.
- The MyStemKits Classroom & E3 Bundle includes a 1 year subscription to the MyStemKits Classroom Plan (maximum of 1 teacher account) and (2) Robo E3 3D Printers, (20) 500g rolls of filament, and (2) 2 hour online training modules.

Item #	Description	Model Number	Quantity	List Price
5-2100803-670	Robo E3 3D Printer	MYSTEMKITCLRME3	Each	\$4,342.95



**Robo™ E3 3D Printer Pro**

- Robo E3 Pro Professional Grade Education 3D printer with Wi-Fi and safety enclosure. 9.8" x 11" x 11.8" build volume 30plus material compatible.
- Includes subscription to MyStemKits.com STEAM curriculum platform.
- The Robo E3 Pro comes with one of the largest build volumes for desktop education 3D printers as well as an extended 2 year warranty, spare parts pack, 2 hours of online training and certification, a 500g spool of filament, as well as a starter plan to our K12 MyStemKits curriculum so teachers can utilize their 3D printer quickly and effectively.

Item #	Description	Model Number	Quantity	List Price
5-2100800-670	Robo E3 3D Printer	E3PRO3DPRINTER	Each	\$3,766.95



**Robo™ E3 3D Printer**

- Robo E3 Education 3D printer with Wi-Fi and full safety enclosure, including HEPA filter. 6" x 6" x 6" build platform PLA plus ABS compatible.
- The Robo E3 comes with an extended 2 year warranty, spare parts pack, 2 hours of online training and certification, a 500g spool of filament, as well as a starter plan to our K12 MyStemKits curriculum so teachers can utilize their 3D printer quickly and effectively.

Item #	Description	Model Number	Quantity	List Price
5-2100801-670	Robo E3 3D Printer	E33DPRINTER	Each	\$1,587.95

**Robo™ E3 3D Printer Plus Classroom Bundle**

- Deliver STEM education in an interactive and engaging manner, using 3D printing to create manipulatives for over 250 hands on STEM projects for K12 students.
- The MyStemKits School & E3 Pro Bundle includes a 1 year subscription to the MyStemKits Classroom Plan and (2) Robo E3 Pro 3D Printers, (20) 500g rolls of filament, and (2) 2 hour online training modules.

Item #	Description	Model Number	Quantity	List Price
5-2100802-670	Robo E3 3D Printer Filament	MYSTEMKITCLSE3PRG	Each	\$7,718.95



**Robo™ E3 3D Printer Filament**

- This 10 pack of 500g PLA filament is easy to use, non toxic, odorless, and biodegradable. (also works with a wide range of other 3D printers).
- Pack comes with 2 black, 2 white, 2 red, 2 blue, and 2 green rolls of PLA filament.

Item #	Description	Model Number	Quantity	List Price
5-2100804-670	Robo E3 3D Printer	PLA10PACKGROUP	Each	\$392.95



**MakerBot™ Sketch 3D Printer Classroom Bundle**

**The Ideal Classroom Setup**

- Featuring a dual-printer set up, educators can offer the ideal student-to-printer ratio to drive 3D printing classroom success right from the start.
- With teacher and student certifications and more than 600+ lesson plans included, educators can integrate more interactive design projects and increase student engagement.

Item #	Description	Model Number	Quantity	List Price
5N-2029057-670	Sketch Printer Bundle	SKETCHKIT	Kit	\$1,798.99



**MakerBot™ Replicator+ 3D Printer**

Print high-quality models faster, easier, and with a bigger build volume. Combined with MakerBot's powerful workflow tools, the MakerBot Replicator+ streamlines desktop 3D printing for professionals and educators.

- Quick setup in less than 30 minutes
- Engineered and Tested for Reliability
- Easy-swap Smart Extruder+ provides a tool-free maintenance experience

Item #	Description	Model Number	Quantity	List Price
5N-1582551-670	Replicator+ 3D Printer	MP07825	Each	\$1,998.99

**Makerbot™ Small Filament Pack**

- MakerBot PLA Filament is the best, most consistent, and most tested filament for the MakerBot Replicator 2 Desktop 3D Printer
- Size Small PLA Filament - 10 Pack (Black, White, Red, Orange, Yellow, Green, Blue, Purple, Warm Gray, Cool Gray)
- Made in USA

Item #	Description	Model Number	Quantity	List Price
5N-1542362-670	PLA Filament	MP06591	Pack of 10	\$159.99



**Makerbot™ Method 3D Printer**

- The MakerBot Method is a professional-grade 3D printer that allows you to print ultra-precision parts with a 60°C heated chamber.
- It prints 2 times faster than leading desktop printers and offers a seamless CAD to Part workflow.
- Developed from the ground up leveraging industry-leading Stratasys® patents, Method features high quality components like a heated build chamber, precision dissolvable supports, and dry-sealed material bays.

Item #	Description	Model Number	Quantity	List Price
5N-2039276-670	Method 3D Printer	900-0001A	Each	\$4,998.99



**Makerbot™ Method X 3D Printer**

- Featuring a 100°C heated chamber, the Method X is able to print a wide range of complex and durable ABS parts and ASA materials.
- Powered through Stratasys® patents, Method X features a heated build chamber, dissolvable supports, and dry-sealed material bays.
- Perfect for manufacturing tools, end-user parts and functional prototypes.

Item #	Description	Model Number	Quantity	List Price
5N-2039277-670	Method X 3D Printer	900-0002A	Each	\$6,498.99

ENTIRE PAGE  
NEW



**HamiltonBuhl® Creator's Level Starter STEAM/STEM Kit**

- Bring STEAM curriculum to life with the HamiltonBuhl® STEAM Creator's Deluxe Kit Full of green screen and stop motion animation creations, Virtual Reality game creation, plus versatile digital camera, tripod stand and 3D Pen Kits!

Item #	Description	Model Number	Quantity	List Price
5-2100965-670	Creators Starter Kit	STEAM-1B	Kit	\$2,383.95



**HamiltonBuhl® Beginner Level Starter STEAM/STEM Kit**

- Students can collaborate to program Edison robots, see their faces light up when they make Circuit Mania's circuitry light up, prepare a script and learn to use stop motion animation, use a green screen to broadcast a show, news or weather, and use any background from anywhere in the world, add captions to the teleprompter, and create almost anything with the 3Doodler Pen Kit, with 6 3Doodler pens, lesson plans and teacher guides to maximize student creative ability!

Item #	Description	Model Number	Quantity	List Price
5-2100966-670	Beginner Starter Kit	STEAM-2BE	Kit	\$3,934.95

**HamiltonBuhl® Intermediate Level Starter STEAM/STEM Kit**

- Students can collaborate to program Edison robots in numerous ways, learn to use to create stop motion animations, write a script and use a green screen to broadcast a show, news or weather, and use any background from anywhere in the world, add captions to the teleprompter, draw almost anything in 3D with the 3Doodler®, discover the microscopic world with the included two Scout Microscopes and maximize student creative ability!



Item #	Description	Model Number	Quantity	List Price
5-2100962-670	Intermediate Starter Kit	STEAM-3B	Kit	\$2,980.95



**HamiltonBuhl® Creator's Level Deluxe STEAM/STEM Kit**

- HamiltonBuhl® STEAM Creator's Deluxe Kit Full of green screen and stop motion animation creations, Virtual Reality game creation, plus versatile digital camera, tripod stand and 3D Pen Kits!
- Students can collaborate to create stop motion animations, write a script and use a green screen to broadcast a show, news or weather, and use any background from anywhere in the world, add captions to the teleprompter, draw in 3D with the 3Doodler®, learn to shoot great photos and videos with the VividPro™ Camera and Octopus Tripod, and maximize student creative ability with VR Quest®.

Item #	Description	Model Number	Quantity	List Price
5-2100963-670	Creators Deluxe Kit	STEAM-1D	Kit	\$2,682.95



**HamiltonBuhl® Beginner Level Deluxe STEAM/STEM Kit**

- This HamiltonBuhl® Deluxe Kit is filled with new ways to create and learn. From programming and robotics, and LED circuitry to green screen broadcasting to stop motion animation, and from microscopic fun to unearthing and putting together ancient dinosaurs, this kit is chock full of fun and learning!
- Students can collaborate to program Edison robots, prepare a script and learn to use to create stop motion animations, use a green screen to broadcast a show, news or weather, and use any background from anywhere in the world, add captions to the teleprompter, and maximize student creative ability!

Item #	Description	Model Number	Quantity	List Price
5-2100960-670	Beginner Deluxe Kit	STEAM-2DX	Kit	\$1,334.95



**HamiltonBuhl® Intermediate Level Deluxe STEAM/STEM Kit**

- From programming and robotics, to green screen broadcasting to stop motion animation, and microscopic discovery, this kit is chock full of fun and will have students excited to use all these tools for STEAM/STEM learning!
- Students can collaborate to program Edison robots in numerous ways, learn to use to create stop motion animations, write a script and use a green screen to broadcast a show, news or weather, and use any background from anywhere in the world, add captions to the teleprompter, study and be amazed by the microscopic world, broadcast a professional podcast, draw in 3D with the 3Doodler®, and maximize student creative ability!

Item #	Description	Model Number	Quantity	List Price
5-2100964-670	Intermediate Deluxe Kit	STEAM-4i	Kit	\$5,303.95



**HamiltonBuhl® STEAM Animation Studio Kit**

- The simple and easy to use Animate It! software has an intuitive interface with stunningly powerful features that will have your students creating stop motion animations in no time!
- The Animation Studio Kit includes a 10x digital zoom 5MP gooseneck webcam with anon slip base and Animate It! stop motion animation software, developed by the award winning makers of "Wallace & Gromit."



**NEW**

Item #	Description	Model Number	Quantity	List Price
5-2100961-670	Large Studio Production Kit	ANI-KIT	Kit	\$195.95

**HamiltonBuhl® Green Screen Production Kit**

- "Students as producers" provides engaging opportunities to teach digital literacy, citizenship and creator's rights.
- The HB Green Screen Production Kit includes presentation software, green screen backdrop, digital zoom webcam and an instruction booklet.



Item #	Description	Model Number	Quantity	List Price
5-2000877-670	HB Green Screen Production Kit	GRN-KIT	Kit	\$331.95

**HamiltonBuhl® On-Air!™ Podcast Kit**

- On-Air! has specially designed this podcast kit to provide excellent sound quality for recording music, singing and podcasting needs.
- The equipment is compatible with Windows and Mac OS.
- A double nylon layer filter provides noise protection and the sound isolation shield helps to get clean, controlled and noise-free recordings. Great for podcasts, YouTube and music recordings.



**Kit Includes:**

- 1 USB Omnidirectional/Cardioid podcasting microphone with desktop stand
- 1 round microphone windscreen/pop filter
- 1 folding sound isolation shield

Item #	Description	Model Number	Quantity	List Price
5-2039504-670	On-Air! Podcast Kit	PCAST4	Kit	\$419.95

**HamiltonBuhl® STEM VR Kit for Social Emotional Learning**

- STEM VR and High Tech Kit for Social Emotional Learning - full of broadcasting production products, including animation kits, green screen kits, digital camcorders with external microphones, tripods, and VR game building software, too!

**NEW**



Item #	Description	Model Number	Quantity	List Price
5-2100967-670	Large Studio Production Kit	STEM-SEL	Kit	\$2,383.95



**NEW**

**JLAB® Epic Talk USB Microphone**

- Meet Epic Talk, the ultimate professional level microphone featuring the highest quality 192kHz/24BIT resolution in the game. Offering three condensers and 4 directional pattern modes to give you the best experience no matter what you're recording: Podcasts, game streams, music or voice, even ASMR.

Item #	Description	Model Number	Quantity	List Price
5-2102422-670	White	MEPICTALKRWHT4	Each	\$236.95
5-2102424-670	Black	MEPICTALKRBLK4	Each	\$236.95

**NEW**

**JLAB® JBuds Talk USB Microphone**

- Meet JBuds Talk, a compact, lightweight and portable microphone, with studio-quality performance. Offering a generous resolution of 96kHz/24BIT, JBuds Talk is great for calls, podcasts, gaming, ASMR, and voice overs using its four directional pattern modes, Stereo, Bidirectional, Cardioid and Omnidirectional.



Item #	Description	Model Number	Quantity	List Price
5-2102429-670	Black	MJBUDSTALKRBLK4	Each	\$152.95
5-2102427-670	White	MJBUDSTALKRWHT4	Each	\$152.95

**JLAB® GO Talk USB Microphone**

- Meet GO Talk, a compact, lightweight and portable microphone, with studio quality performance.
- Offering a generous resolution of 96kHz/24BIT, GO Talk is great for calls, podcasts, gaming, ASMR, and voice overs using its two directional pattern modes, Cardioid and Omnidirectional.

Item #	Description	Model Number	Quantity	List Price
5-2102419-670	Black	MTALKGO2RBLK4	Each	\$78.95
5-2102421-670	White	MTALKGO2RWHT4	Each	\$78.95

**NEW**





### Promethean ActivPanel Nickel Interactive Display

- Features Vellum Writing Technology with 15 continuous touch points and 16GB of internal storage.
- Provides front and rear HDMI, USB-A 2.0 and 3.0 and USB-B Touch, USB-C connectivity ports and included Wi-Fi module.
- Has essential apps such as Whiteboard, Annotate, Timer, Spinner, Screen Capture, Screen Share, PDF Reader and more and is compatible with Windows 8 to 10, OSX 10.8 to 10.11, macOS Sierra 10.12.1 or later, Linux Ubuntu 18.04 LTS Chrome OS.

Item #	Model Number	Screen Size	Warranty	Quantity	List Price
6N-2088405-670	AP7E-U65-NA-1	65 in	3 YEAR	Each	\$3,031.99
6N-2088403-670	AP7E-U75-NA-1	75 in	3 YEAR	Each	\$5,922.99
6N-2088407-670	AP7E-U86-NA-1	86 in	3 YEAR	Each	\$9,026.99



### i3SIXTY Flipchart Pro

- With the i3SIXTY Pro, you can whiteboard, present wirelessly, video conference and annotate on your shared content. It has everything you need for remote collaboration and fits in any space.



Item #	Description	Model Number	Screen Size	Warranty	Quantity	List Price
6-2104323-670	i3Sixty Flipchart Pro, White	10010257	55 in	3 YEAR	Each	\$11,636.95
6-2104316-670	i3Sixty Flipchart Pro, Black	10010256	55 in	3 YEAR	Each	\$11,636.95



### i3SIXTY 2 Flipchart

- The i3SIXTY 2 is a new spin on the interactive digital flipchart. Minimize clutter and maximize collaboration, whether you are in breakout groups or in a small space, roll the i3SIXTY 2 where and when you need it.

Item #	Description	Model Number	Screen Size	Warranty	Quantity	List Price
6-2104315-670	i3Sixty Flipchart 2	10010342	43 in	5 YEAR	Each	\$7,758.95
6-2104309-670	i3 Camera	10010360	-	2 YEAR	Each	\$651.95



**NEW**

**i3Touch X-One Display**

- Work at the speed of thought thanks to Android 11 and an Octa-Core CPU with 8GB of RAM.
- It's a robust, powerful, and intuitive device that is easy for anyone to use.
- We make the maintenance of your device simple with automatic over-the-air updates and remote management capabilities.

Item #	Description	Model Number	Screen Size	Warranty	Quantity	List Price
6-2104320-670	i3Touch X-One Display	10010312	65 in	8 YEAR	Each	\$6,327.95
6-2104314-670	i3Touch X-One Display	10010313	75 in	8 YEAR	Each	\$9,083.95
6-2104312-670	i3Touch X-One Display	10010314	86 in	8 YEAR	Each	\$11,266.95

**NEW**

**i3Touch E-One Display**

- The i3Touch E-One delivers durability, and an all in one integrated experience for an incredible value. With high precision IR technology and zero air gap, the E ONE gives you an excellent multi touch experience.



Item #	Description	Model Number	Screen Size	Warranty	Quantity	List Price
6-2104319-670	i3Touch E-One Display	10010352	86 in	5 YEAR	Each	\$5,756.95
6-2104318-670	i3Touch E-One Display	10010353	75 in	5 YEAR	Each	\$8,448.95
6-2104311-670	i3Touch E-One Display	10010354	65 in	5 YEAR	Each	\$10,495.95



**NEW**

**i3 Camera FHD**

- A full HD wide angle camera that can easily capture the entire classroom, and delivers great sound and image quality.

Item #	Description	Model Number	Warranty	Quantity	List Price
6-2104309-670	i3 Camera	10010360	2 YEAR	Each	\$651.95





### LG® 70 Series HDR Smart LED TV

- Intuitive interface to control movies, TV shows, online content and much more from content providers.
- Exceptional brightness and energy efficiency of LED
- Able to use the most popular streaming video apps like Netflix, YouTube, Hulu, Amazon Video, VUDU and much more.

Item #	Model Number	Resolution	Screen Size	Quantity	List Price
5-2051116-670	43UN7000PUB	4K Ultra HD	43 in	Each	\$884.95

### LG® UHD 4K HDR Smart LED TV with AI ThinQ®

- The LG® UHD 4K HDR Smart LED TV is engineered with real 4K displays for four times the resolution of a standard TV.
- Compatibility with smart assistants like Google home and Alexa
- Access the Apple TV app, Disney+, Netflix, and LG Channels and find them all in one place.
- 20W output power, 2 HDMI ports, 1 ethernet input, 2.0V USB ports and Wi-Fi certified 802.11ac.
- 1 Year Parts & Labor Warranty.



Item #	Model Number	Resolution	Screen Size	Quantity	List Price
6-2088311-670	55UN7000PUN	4K Ultra HD	55 in	Each	\$1,172.95



NEW

### LG® 80 Series Smart UHD TV with AI ThinQ®

- The LG 43 inch 80 Series provides the rich 4K display delivers quality you can see in every scene.
- The quad core processor 4K gives a smooth, crisp viewing experience with enhanced contrast, color and darks. ThinQ AI and the magic remote enable simple navigation and intuitive voice commands while the webOS platform supports a huge library of content with many of the most popular streaming apps
- Works with Hey Google, Amazon Alexa, Apple Play2, and Applet Homekit.

Item #	Model Number	Resolution	Screen Size	Quantity	List Price
5-2091439-670	43UP8000	4K Ultra HD	43 inch	Each	\$1,415.95

## CLASSROOM SELECT

### Classroom Select® Media Wall Flat Panel Cart

Classroom Select® Media Wall and Cart System with power provides an easy transition for a multimedia learning environment. The unit accommodates a flat panel display up to 60" or 125 pounds. The black laminate finish adds a modern twist with a removable back panel for easy access to equipment and cables. Keep cables organized with the wire channel in the main pillar by using the multiple grommets. Four durable casters allow for easy mobility and lock for safe stability. Adjustable bracket provides optimum viewing angle.



Flat Panel Not Included

Item #	Description	Product Dimensions	Color	List Price
6-2104604-670	Media Wall with Power	34.1 W x 21.8 D x 70 H in	Titanium	\$985.95



### MooreCo® MediaSpace Flat Panel Cart

The sleek and stylish MediaSpace Flat Panel cart provides safe and easy flat panel mobility while adding modern elegance to any multimedia environment, with durable design, materials and versatile storage options. Fits a flat panel display up to 60". Cable management built in.



Flat Panel Not Included

Item #	Description	Product Dimensions	List Price
6-1595175-670	Flat Panel Media Cart	34 W x 22 D x 70 H in	\$2,191.95

## LUXOR

### Luxor CLCD Crank Adjustable Flat Panel TV Cart

The Luxor CLCD LCD TV Cart is ideal for office applications, presentations, and more. The frame is constructed from durable steel and shelves from MDF with melamine top.

The unit measures 30 W x 29-1/2 D and is adjustable in height from 50" to 66". The Crank handle allows for easy height adjustment.

Unit includes two flat shelves with a clearance between shelves of 19-1/2" for easy access. Stand holds up to a 80" LCD TV with flat panel and includes mounting hardware. Allows up to a 15° tilt of adjustment with lock included to deter theft. Mobile TV cart with four 3" industrial casters, two with locks.

Maximum total cart weight capacity of 270 pounds. (75 pounds per shelf, 120 pounds, maximum TV weight, all evenly distributed). Some assembly required.



Flat Panel Not Included

Item #	Description	Product Dimensions	Color	List Price
6-1571521-670	Crank Adjustable TV Cart	30Wx29-1/2D x50-1/2-66-1/4H in	Black/Gray	\$946.95

### Mooreco® iTeach Spider Flat Panel Cart



Engage your students anywhere with either version of the modern black iTeach Spider Flat Panel Cart, a stylish solution to your flat panel mobility needs. Available in either an electric or manual height adjustable model. Sleek black finish adds a dramatic and modern touch to any environment. Each supports a display up to 100" / 250 lbs (to include all cables and accessories). VESA mount size up to 800 x 600.



Flat Panel Not Included

Item #	Description	Product Dimensions	Color	List Price
6-2021401-670	Flat Panel Cart, Electric	57-1/2W x 34-1/2D x 71-1/2H in	Black	\$4,822.95
6-2021365-670	Flat Panel Cart, Manual	58 W x 30-1/4 D x 74 H in	Black	\$2,434.95
6-2021402-670	Convert Manual to Electric	37-1/2 W x 8 D x 36-46 H in		\$2,879.95



### Kanto Living Full Motion Flat Panel Mount

Full motion mount. Sits 2" from the wall and extends up to 24", the PDX680 is the perfect solution for versatility. This wall mount offers 18° of tilt and a 27" wall plate to accommodate up to 24" studs. With integrated cable management and plastic caps to hide the lag bolts in the wall, the PDX680 is not only functional, but easier for your students to see too.

Item #	Description	Color	List Price
9-2020254-670	TV Wall Mount - PDX680	Black	\$351.95



### GPX® Mini Projector with Bluetooth

- The GPX mini projector can project your favorite movies, games, and photos up to a 100 in screen size with HDMI, VGA, USB, and AV.
- Connect your speakers to the audio out, a Bluetooth speaker, or use the built-in speaker to complete the scene.
- The projector includes remote control, 3.5 mm to 3x RCA audio/video cable, AC/DC power adapter, 90 day limited warranty and user's guide.



Item #	Model Number	Wi Fi	Resolution	Contrast	Lamp Life	Lumens	Built In Speaker	List Price
5-2039518-670	PJ300B	Yes	800 x 480	1000:1	20,000 hr	2000	10 Watt	\$338.95



### Dukane® ImagePro Projectors

- Ideal for education and small-to-medium-sized business environments that need essential features, including bright colorful images, automatic technologies, and eco-friendly appeal.
- They offer lamp life up to 10,000 hours at full output (20,000 hrs in eco mode) and a high contrast ratio of up to 16,000:1.
- The environment is kept in mind with ECO Mode technology, a carbon savings meter, extended filter life, and energy-saving features such as quick startup and direct power off.
- MultiPresenter functionality allows for screen mirroring of up to 16 devices simultaneously (Android and Windows) via a wired or wireless connection (wireless adapter required). (Win, MAC, Android, iOS) (No internet access or WAN required).

Item #	Model Number	Wi Fi	Resolution	Contrast	Lamp Life	Lumens	Built In Speaker	List Price
5-2088082-670	6442W	Yes	1280 x 800	16,000:1	20,000 hr	4200	16 Watt	\$2,266.95
5-2088081-670	6445X	Yes	1280 x 768	16,000:1	20,000 hr	4500	16 Watt	\$2,022.95

### Dukane® ImagePro 6543WL Projector

- The 4300 lumen, WXGA (1280 x 800) native resolution 6543WL is ideal for classrooms that need a clear image that can be seen all around the room.
- Enjoy the convenience of vertical lens shift, direct power on, and quick power off.
- The 6543WL offers a long term, maintenance free solution and a low total cost of ownership.



Item #	Model Number	Resolution	Contrast	Lamp Life	Lumens	Built In Speaker	List Price
5-2103703-670	6543WL	1280 x 800	2000:1	30,000 hr	4300	10 Watt	\$4,227.95



### Dukane® ImagePro 6652WL Projector

- With 5200 lumens, WXGA resolution and outstanding LCD color fidelity the ImagePro 6652WL delivers impressive images in demanding applications.
- Installation flexibility is achieved with a compact design and broad horizontal and vertical manual lens shift.
- The 20,000 hour laser life creates a low TCO projection solution.



Item #	Model Number	Resolution	Contrast	Lamp Life	Lumens	Built In Speaker	List Price
5-2103704-670	6652WL	1280 x 800	3,000,000:1	30,000 hr	5200	16 Watt	\$4,756.95

### ViewSonic® Multimedia Projectors

- This Viewsonic Projector with 3,600 lumens features exclusive SuperColor technology to offer a wide color gamut.
- Extensive connectivity include HDMI, two VGA ports, VGA out, composite video and audio in/out.
- Energy-saving SuperEco reduces power consumption and extends the lamp life by up to 15,000 hours.
- Equipped with the latest HDMI, this projector can connect to any HDMI-enabled device and display 3D images directly from 3D Blu-ray players.
- 3 year warranty.



Item #	Model Number	Wi Fi	Resolution	Contrast	Lamp Life	Lumens	List Price
5-2049331-670	PA503X	No	1024 x 768	22000:1	4,500 hr	3600	\$1,159.95
5-2049329-670	PA503S	No	1024 x 768	22000:1	4,500 hr	3600	\$868.95



### Epson® Power Lite Wireless LCD Projector

- This ultra thin, 4 lb model provides 3,200 lumens of color brightness, 3,200 lumens of white brightness and 1080p resolution — ideal for Full HD-quality content.
- Featuring Miracast, the latest in wireless connectivity, the 1795F can mirror content from a smartphone or streaming device.
- It also supports Chromecast, Roku and MHL-enabled devices.

Item #	Model Number	Wi Fi	Resolution	Contrast	Lamp Life	Lumens	Built In Speaker	List Price
6-1588268-670	V11H796020	Yes	1920 x 1200	10000:1	7,000 hr	3200	1 Watt	\$3,035.95



**HoverCam®  
Ultra 8 Document Camera**

- Features HDMI, VGA and SuperSpeed USB 3.0 video outputs with 8.0 MegaPixel resolution and 60 frames/sec speed.
- Connect it directly to a monitor or projector without a computer using an HDMI or VGA cable, or, use it with a computer with the USB cable to display live HD video for instruction, training and presentations.
- Take snap shots and record video directly to a SD card.
- It includes a LCD preview monitor that is also used for touch screen control. It's also a scanner, HD webcam and video recorder.



Item #	Description	Model Number	Product Resolution	Warranty	List Price
5-1532328-670	Ultra 8 HoverCam	HCU8	1080p	2 YEAR	\$1,198.95

**Dukane®  
150 Document Camera**

- Single USB port combining both power and imaging to achieve a fast-easy connection.
- Connecting the Camera 150 to a Windows computer you get a view of the material being presented.
- High definition with 8 megapixels means superior image quality and optical zoom to 100X means outstanding detail.



Item #	Description	Model Number	Product Resolution	Warranty	List Price
5-2020045-670	Document Camera	150	1080p	1 YEAR	\$518.95

**HoverCam® Solo 8+ Document Camera**

- The HoverCam Solo 8 is a SuperSpeed USB 3.0 document camera delivering 8 megapixel resolution and true 30 frames per second full motion, lag-free video. The Solo 8 comes pre-loaded with the HoverCam FLEX 10 software.



Item #	Description	Model Number	Product Resolution	Warranty	List Price
5-1598654-670	Solo 8+ Document Camera	HCS8+	1080P	2 YEAR	\$834.95

**Dukane® 446 Document Camera**

- 16x zoom capability (8x optical zoom, 2x sensor zoom) and a professional image sensor to deliver vivid colors at high-definition, Full HD, 1080p output resolutions with 30 frames per second.
- The internal memory stores up to 240 images and is expandable to 32GB using a USB flash drive.
- One-touch video recording allows for recording stand-alone presentations without the need for a PC.
- The jointless, highly flexible gooseneck enables a 360 viewing angle and object viewing from just 1.2 inch (3 cm) to observe an objects finer details.



Item #	Description	Model Number	Product Resolution	Warranty	List Price
5-1483663-670	Gooseneck Camera	446A	1080p	5 YEAR	\$1,059.95



**Luna™ 2.0 Interactive Projection Camera**

- Easy-to-use digital projection camera is also a web cam and photo/video camera.
- Connects via USB port to use with your computer or interactive whiteboard.
- Features 3.0MP digital images, adjustable gooseneck, auto focus, 8 LED lights.
- Compatible with PC and Mac. 20 inches tall. Works well with Quick Time.

Item #	Description	Model Number	Product Resolution	List Price
5-1534091-670	Luna Projection Camera	LER 4400	2048 x 1536	\$295.95



### Califone® PA21-EDU Bluetooth® PA System

- Equipped with wheels and retractable handle in a light-weight ABS design
- Built with a frequency range of 10 DB equaling 50 HZ - 20 HZ, measuring 21-3/4 in H x 14-1/2 in L x 14 in W, and weighing 35 pounds
- Includes a 2 channel UHF wireless microphone system; a media player with stereo Bluetooth®, USB port and complete mixer with echo, talk-over, EQ functions and much more
- Equipped with one 10 inch woofer and a 1.35 inch voice coil titanium driver and high capacity 12 V 7.5 AH battery
- 5 hours of playback at maximal volume
- 2 Year Warranty

Item #	Description	Model Number	Watts	Bluetooth	Quantity	List Price
5-2041058-670	Wireless PA System	PA21-EDU	100	Yes	Each	\$1,111.95

### Califone® Microphones

- Compatible with Califone® PA Systems
- 1 Year Warranty

Item #	Description	Model Number	Quantity	List Price
A 5-1544059-670	Headset Mic	HBM319	Each	\$22.95
B 5-1543838-670	Electric Lapel Mic	LM319	Each	\$24.95
C 5-1543820-670	Beltpack Transmitter	M319	Each	\$123.95
D 5-1543863-670	Wireless Handheld Mic	Q319	Each	\$152.95



### Califone® PA Megaphones

- Whether for athletes, for tour groups, or for emergency response situations, the importance of a clearly heard message can be critical. Choose from 8, 15, or 25 watts

#### Features:

- Rugged ABS plastic for durability
- Shoulder strap
- Volume control
- Talk/Siren switch
- Power/Record indicators (PA-25R only)
- Speak/Record/Play Buttons (PA-25R only)
- Detachable microphone (PA-25R only)
- 1 Year Warranty



PA-20R Megaphone

PA-15 Megaphone

### Califone® PA219 Wireless Megaphone

- Califone's Wireless Megaphone's versatility is critical when leading tour groups, directing activities on an athletic field, or in emergency response situations
- PA219 delivers a wireless mic (with a wired mic input), an input to connect a smartphone, a card reader, and a USB port
- 750 ft range, the PA219 broadcasts music or messages so the entire crowd can hear critical information
- Rugged ABS plastic exterior with comfy handle, digital read out, SD card slot and USB port, wireless microphone, MP3 controls, volume controls and 5" speaker for projection
- 1 Year Warranty



Item #	Description	Model Number	Range	Quantity	List Price
5-1543919-670	Wireless Megaphone	PA219	750 ft	Each	\$360.95



### SuperSonic® Bluetooth® Portable PA System

- Built-in Bluetooth receiver allows you to wirelessly connect to an iPad, iPhone, Smartphone, Android tablet, laptop and other devices
- LED display with a built-in FM radio, USB, Micro SD, AUX inputs to play your favorite music from external devices, also a karaoke jack and a recording/repeat feature
- Equipped with rechargeable batteries (AC 110V-220V & DC 5V) you can use both batteries at the same time or use one as a backup. 5 watt power output with a frequency response 100Hz - 18KHz

Item #	Description	Model Number	Watts	Bluetooth	Quantity	List Price
5-2067755-670	Black	SC-1443BT	5W	Yes	Each	\$48.95
5-2088401-670	Blue	SC-1443BT-BLUE	5W	Yes	Each	\$48.95
5-2088402-670	Red	SC-1443BT-RED	5W	Yes	Each	\$48.95

### Oklahoma Sound® Wireless PA System

- Weighs 19 lbs. and is easily transportable with its built-in handle
- A 40-watt solid state amplifier is matched to an 8" built-in speaker
- Broadcast effortlessly up to 100 feet away from receiver/speaker
- The control panel also includes a 1/4" mic input for additional wired microphones, as well as a 1/4" & 1/8" auxiliary inputs for MP3 & other media players
- Sync your smart phone direct to the sound system through built-in Bluetooth technology or play MP3 files through a built-in USB port and includes an SD/MMC Port
- Use with an AC wall plug, or use remotely for up to five hours while powered by its built-in rechargeable lead acid battery. Wireless microphone included
- The built-in underside receptacle allows for tripod set up. Tripod not included
- 10 Year Warranty

Item #	Description	Model Number	Watts	Bluetooth	Warranty	Quantity	List Price
5-1584461-670	Wireless PA System	PRA-8000/PRA8-5	40	Yes	10 YEAR	Each	\$742.95





**CaliTuff® Cord**

Our highly durable CaliTuff® Cord is made of braided, PVC-jacketed material that resists cutting and chewing. Includes a reinforced earcup entry point that resists stress separation. Cable management is made easy with a tethered hook and loop strap.



**Califone® 3068 Stereo Over-Ear Headsets**

The 3068 headset delivers over-ear performance at an economical price and has been upgraded with our strongest cord....CaliTuff®. The noise-reducing microphone captures a student's verbal response - not their neighbors, making it ideal for language learning, library uses, and in computer labs. The audio playback is calibrated to enhance the tonal range of the human voice in language learning.

- In-line volume control makes for easy adjustments with little distraction
- 6 foot CaliTuff™ cord
- Ambient noise-reducing, circumaural earcups
- Replaceable, foam-filled, leatherette ear pads
- Padded, adjustable headband fits most sizes
- Rugged ABS plastic head strap and earcups resist breakage



**Califone® 3068AV Switchable Stereo/Mono Over-Ear Headphones**

We've updated the cord to CaliTuff™, making this classic Califone® headphone versatile and even tougher! With the flip of switch, these headphones go from mono to stereo, providing maximum utility as students move from monaural functions (typical for ELL/ELD lesson) to stereo requirements of computer workstations and online learning.

- Volume control on each cup for optimal hearing and comfort
- 10 foot CaliTuff™ cord
- Ambient noise-reducing, circumaural earcups
- Replaceable, foam-filled, leatherette ear pads
- Padded, adjustable headband fits most sizes
- Rugged ABS plastic head strap and earcups resist breakage

3 year warranty  
Available March 2023

Item #	Model Number	Plug Type	Color	Quantity	List Price
5-2103819-670	3068AV-CT	3.5mm w/ 1/4 in adapter	Black	Each	\$18.95
5-1543923-670	EP3030 Ear Pad Replacements	-	Black	1 Pair	\$3.95
5-1465280-670	2924EC Ear Pad Covers	-	Black	12 Pairs	\$19.95

**Califone® Carrying Case**

Protect your audio investment with this rugged carrying/storage case.

- 21"L x 17"H x 10"D external dimensions
  - 19"L x 14-3/4"H x 8-1/2"D interior dimensions
  - Outer shell made of black polypropylene that resists marring and scratching
  - 1" thick foam-lined interior
  - Opposing outer clasps prevent accidental opening
  - Comfortably holds twelve sets of 2103819, ten sets of 2103825 or ten sets of 2103827 (not included)
- 1 year warranty



Item #	Model Number	Color	Quantity	List Price
5-1543869-670	2005	Black	Each	\$99.95

Item #	Model Number	Plug Type	Color	Quantity	List Price
5-2103825-670	3068MT-CT	3.5mm	Black	Each	\$18.95
5-2103827-670	3068MUSB-CT	USB	Black	Each	\$30.95
5-1543923-670	EP3030 Ear Pad Replacements	-	Black	1 Pair	\$3.95
5-1465280-670	2924EC Ear Pad Covers	-	Black	12 Pairs	\$19.95



**Califone® NeoTech Plus® 1017 Over-Ear Headphones & Headsets**

The 1017 Series was designed with enhanced audio playback that is calibrated to mirror the tonal range of the human voice. Microphones are noise-canceling and unidirectional to optimize the fidelity of voice input. Available with a convenient inline microphone or a flexible gooseneck mic that can swing up when not in use.

- Over-earcups swivel to lay flat for easy storage
  - 6 foot CaliTuff™ cord
  - Noise-isolating, padded ear pads
  - Padded, adjustable headband
  - Rugged ABS plastic head strap and earcups resist breakage
  - Heavy-gauge zippered, plastic bag with personalized label area
- 3 year warranty

Item #	Model Number	Plug Type	Color	Quantity	List Price
<b>Headphone</b>					
5-1609575-670	1017AV	3.5mm	Black	Each	\$30.95
<b>Gooseneck microphone w/inline volume control</b>					
5-1609571-670	1017MT	3.5mm	Black	Each	\$36.95
5-1609572-670	1017MUSB	USB	Black	Each	\$51.95
<b>Inline microphone w/inline volume control</b>					
5-1609573-670	1017IMT	3.5mm	Black	Each	\$36.95
5-1609574-670	1017IMUSB	USB	Black	Each	\$50.95



**Califone® GS3000 Removable Gooseneck Headphones**

Our newest over-ear headset has large, super-soft padded earcups attached to the headband with strong metal arms. When talking isn't required, simply unplug the removable gooseneck microphone.

- Uni-directional microphone on a flexible and removable gooseneck
- 6 foot CaliTuff® cord
- 3.5mm stereo plug
- In-line volume control
- Noise-isolating, padded ear cushions
- Padded, adjustable headband
- Rugged ABS plastic head strap and earcups resist breakage
- Heavy-gauge zippered, plastic bag with personalized label area
- 3 year warranty
- Available March 2023



Item #	Model Number	Color	Quantity	List Price
5-2104612-670	GS3000 BK	Black/Black	Each	\$38.95
5-2104617-670	GS3000 RD	Black/Red	Each	\$38.95



**Califone® 2021 Deluxe Over-ear Headphones**

The 2021 Series offers a lightweight headphone with cobalt transducers that perform with surround sound quality.

- Over-earcups are noise-isolating with foam padded, soft leatherette ear cushions
- In-line volume control
- 6 foot CaliTuff® cord
- Padded, adjustable headband that is strong and flexible
- Polypropylene plastic head strap and earcups resist breakage
- Heavy-gauge zippered, plastic bag with personalized label area
- 3 year warranty

Item #	Model Number	Plug Type	Color	Quantity	List Price
5-2088197-670	2021AV	3.5mm	Black	Each	\$30.95
5-2088194-670	2021AV-USB	USB	Black	Each	\$36.95

**Califone® 2021 Deluxe Over-ear Ambidextrous Headsets with Gooseneck Mic**

With the same design as the 2021 headphones, this headset was built with a gooseneck microphone that swivels 280 degrees, perfect for right or left-handed users.

- Unidirectional, noise-reducing gooseneck microphone 280 degree swivel
- Over-earcups are noise-isolating with foam padded, soft leatherette ear cushions
- In-line volume control
- 6 foot CaliTuff® cord
- Padded, adjustable headband that is strong and flexible
- Polypropylene plastic head strap and earcups resist breakage
- Heavy-gauge zippered, plastic bag with personalized label area
- 3 year warranty

Item #	Model Number	Plug Type	Color	Quantity	List Price
5-2088196-670	2021MT	3.5mm	Black	Each	\$35.95
5-2088195-670	2021MUSB	USB	Black	Each	\$42.95



**Califone® BH-202 Wireless Headset**

This sturdy stereo headset pairs with any Bluetooth-enabled smart device for wireless listening and includes a 4 foot, 3.5mm Aux cable for use with traditional devices. Includes micro-USB cable for recharging Lithium batteries.

- Earcups have user-friendly buttons for power, volume control, play, pause, next and previous.
- Uni-directional, noise-reducing microphone
- LED light indicate charging needs and successful pairing
- 4 foot Aux-T cable with volume control
- Internal Lithium rechargeable battery with micro-USB cord for charging
- Noise-isolating, padded ear cushions
- Padded, adjustable headband
- Rugged polypropylene head strap and earcups resist breakage
- 1 year warranty

Item #	Model Number	Plug Type	Color	Quantity	List Price
5-2088912-670	BH-202	Aux-T	Black	Each	\$32.95

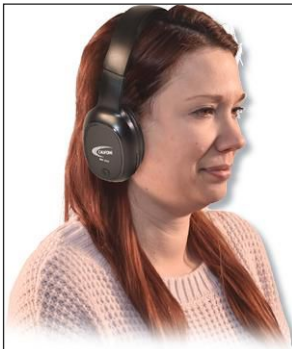



**JLAB® Jbuddies Over-Ear Folding Kids Headphones**

**Fits Ages 6 Years Old and Up**

- Smooth-sliding metal adjustments and feather-light build give the long-lasting, all-day comfort kids require
- Tested and approved for safe listening with built in volume-limiter at 85dB
- Includes an inline universal microphone with track controls
- Lifetime Limited Warranty.

Item #	Model Number	Plug Type	Color	Quantity	List Price
5-2004906-670	JKSTUDIO-GRYPPL-BOX	3.5mm	Gray/Purple	Each	\$22.95
5-2004907-670	JKSTUDIO-GRYBLU-BOX	3.5mm	Gray/Blue	Each	\$22.95



**NEW**

**JLAB® Studio Pro Over-Ear Headphones**

- C3 sound technology and 40mm neodymium drivers produce crisp, detailed audio and thumping bass for optimal immersion
- 90 degree jack is compatible with most cases and devices for versatile use
- Integrated universal mic enhances clarity during voice calls
- Built in buttons ensure easy operation and control over track functions and volume functions
- Wired headphones have a braided nylon cord to prevent tangling
- Compact, feather light build and foldable design makes them easy to carry on the go
- 2 Year Limited Warranty

Item #	Model Number	Plug Type	Color	Quantity	List Price
5-2103609-670	HASTUDIOPRORBLK4	3.5mm	Black	Each	\$32.95



**NEW**

**JLAB® Studio Pro Over-Ear Wireless Headphones**

- Ultra-plush faux leather and Cloud Foam™ cushions
- 50+ hour battery life
- Form-Fit™ earcups with smooth-sliding metal adjustments and feather-light build
- Custom EQ3 Sound

- Universal microphone to make phone calls
- Track and volume controls
- Foldable for easy storage
- 2 Year Limited Warranty
- Choose from Navy, Tropical, Slate or Black. Specify color when ordering

Item #	Model Number	Plug Type	Color	Quantity	List Price
5-5009626-670	HBASTUDIOPROR	Wireless	Specify	Each	\$79.95



**Califone® NeoTech®  
1025 On-Ear Stereo Headset with Gooseneck Microphone**

This mid-weight headset is stylish and provides on-ear listening, ideal for 1:1 learning, assessment testing and more.

- Over-earcups are made of polypropylene to resist breakage in high-use environments
- 6 foot CaliTuff® cord
- Uni-directional microphone is on bendable gooseneck arm that can swivel up when not in use
- Foam-filled leatherette ear cushions are noise-reducing and comfortable
- Padded, adjustable headband is sturdy and highly flexible
- Rugged ABS plastic head strap and earcups resist breakage
- Heavy-gauge zippered, plastic bag with personalized label area
- 3 year warranty

Item #	Model Number	Plug Type	Color	Quantity	List Price
5-1609576-670	1025MT	3.5mm	Black/Silver	Each	\$26.95
5-1609577-670	1025MUSB	USB	Black/Silver	Each	\$39.95

**CaliTuff® Cord**

Our highly durable CaliTuff® Cord is made of braided, PVC-jacketed material that resists cutting and chewing. Includes a reinforced earcup entry point that resists stress separation. Cable management is made easy with a tethered hook and loop strap.



**JLAB® Studio On-Ear Headphones**

- Plug in and GO anywhere with the Studio Headphones
- Braided nylon cord is durable to use all day, everyday
- C3 Sound delivers crystal, clear, clarity audio so music sounds perfect every time
- Fold the earcups in for compact size to fit in any bag
- These are the perfect go-to headphone for student use
- Limited Lifetime warranty.

Item #	Model Number	Plug Type	Color	Quantity	List Price
5-2020315-670	HASTUDIORBLK4	3.5mm	Black	Each	\$23.95
5-2020319-670	HASTUDIORGRYBLU4	3.5mm	Blue/Gray	Each	\$23.95



**JLAB® Audio Studio Wireless On-Ear Headphones**

- 30+ hour battery life with Bluetooth 5
- Full control of music with the touch of a button
- Adjust EQ3 Sound, choose between Signature, Balanced, and Bass Boost
- Ultra-plush faux leather and Cloud Foam™ ear cushions and headband provide a studio look and feel
- 2 Year Limited Warranty

Item #	Model Number	Color	Quantity	List Price
5-2020316-670	HBASTUDIORGRYBLU4	Blue/Gray	Each	\$48.95
5-2020312-670	HBASTUDIORBLK4	Black	Each	\$48.95



**JLAB® Go Work Wireless On-Ear Headset**

- Connect wirelessly via Bluetooth (version 5)
- Plug-in with the included USB-C to 3.5mm cable, takes up to 2 hours to fully charge
- Get a full 45+ hour work week on one charge and all day comfort with Cloud Foam™ earcups
- Rotate the boom microphone up for listening only and back down to take a call or video conference
- Control play, pause, answer, reject, volume, and mute with the convenient multi functional buttons located on the headset
- Red LED light at the end of the mic easily indicates whether the mute is on
- 2 Year Limited Warranty

Item #	Model Number	Plug Type	Color	Quantity	List Price
5-2092032-670	HBGOWORKRBLK4	USB-C, 3.5mm	Black/Blue	Each	\$78.95



ENTIRE PAGE  
**NEW**

THREE YEAR  
**3**  
WARRANTY



**Califone® KH-08 Series On-Ear Headphones**

Our new KH-08 Series is a lightweight option for elementary students that benefit from on-ear listening. Built for high-use environments, these headphones feature our durable CaliTuff® cord and have a flexible headband that can handle all the twists and turns.

- On-ear cups with soft, padded leatherette cushions
- 6 foot CaliTuff® cord
- Flexible plastic headband is fully adjustable

3 year warranty

Item #	Model Number	Plug Type	Color	Quantity	List Price
5-2104609-670	KH-08N BK	3.5mm	Black	Each	\$14.95
5-2104620-670	KH-08N RD	3.5mm	Red	Each	\$14.95
5-2104616-670	KH-08 USB BK	USB	Black	Each	\$22.95



**Califone® KH-08 Series On-Ear Headsets with Microphone**

When verbal interaction is required, the KH-08 Headsets have the same great features as the KH-08 Headphones with two microphone options; gooseneck or in-line.

- In-line volume control
- 6 foot CaliTuff® cord
- Gooseneck microphone is uni-directional and on a bendable arm that easily swings up when not in use
- In-line microphone is omni-directional on a sleek controller that also houses the volume control

3 year warranty

Item #	Model Number	Plug Type	Color	Quantity	List Price
<b>Gooseneck Microphone</b>					
5-2104605-670	KH-08GT BK	3.5mm	Black	Each	\$18.95
5-2104611-670	KH-08GT RD	3.5mm	Red	Each	\$18.95
5-2104619-670	KH-08 GUSB BK	USB	Black	Each	\$26.95
<b>In-line Microphone</b>					
5-2104610-670	KH-08T BK	3.5mm	Black	Each	\$16.95
5-2104614-670	KH-08T RD	3.5mm	Red	Each	\$16.95
5-2104606-670	KH-08 MUSB BK	USB	Black	Each	\$23.95

**CaliTuff® Cord**

Our highly durable CaliTuff® Cord is made of braided, PVC-jacketed material that resists cutting and chewing. Includes a reinforced earcup entry point that resists stress separation. Cable management is made easy with a tethered hook and loop strap.





**CaliTuff® Cord**

Our highly durable CaliTuff® Cord is made of braided, PVC-jacketed material that resists cutting and chewing. Includes a reinforced earcup entry point that resists stress separation. Cable management is made easy with a tethered hook and loop strap.



**Califone® Listening First™ 2800 Over-ear Headphones**

Designed for younger users, these headphones have an extremely flexible headband, replaceable earpads and now the durable CaliTuff® cord.

- Noise-reducing, over-ear cups filter out external distractions
- 6 foot CaliTuff® cord
- Flexible plastic headband is fully adjustable
- 3.5mm stereo plug
- Replaceable, foam-filled leatherette ear pads
- 3 year warranty

Available March 2023

Item #	Model Number	Color	Quantity	List Price
5-2103812-670	2800-BKP CT	Black	Each	\$16.95
5-2103820-670	2800-BL CT	Blue	Each	\$16.95
5-2103811-670	2800-RD CT	Red	Each	\$16.95
5-2103822-670	2800-YL CT	Yellow	Each	\$16.95
<b>Replacement Ear Pads</b>				
5-1543937-670	EP-2800	Black	1 Pair	\$3.95
<b>Disposable Ear Pad Covers</b>				
5-1543931-670	2800-EC	Black	12 Pairs	\$19.95



**Califone® Listening First™ 2810 Over-ear Headphones with Animal Faces**

New animal faces capture the attention of young listeners and an upgrade to the CaliTuff® cord makes the 2810 series even better!

- Noise-reducing, over-ear cups filter out external distractions
- 6 foot CaliTuff® cord
- Flexible plastic headband is fully adjustable
- 3.5mm stereo plug
- Replaceable, foam-filled leatherette ear pads
- 3 year warranty

Available March 2023

Item #	Description	Model Number	Quantity	List Price
5-2103809-670	Black Bear	2810-BLB	Each	\$20.95
5-2103810-670	Fox	2810-FOX	Each	\$20.95
5-2103813-670	Husky	2810-HUS	Each	\$20.95
5-2103815-670	Parrot	2810-PAR	Each	\$20.95
5-2103821-670	Sloth	2810-SLO	Each	\$20.95
5-2103818-670	Tiger	2810-TIG	Each	\$20.95
<b>Replacement Ear Pads</b>				
5-1543937-670	Ear Pad Replacements	EP-2800	1 Pair	\$3.95
5-1543931-670	Disposable Ear Pad Covers	2800-EC	12 Pairs	\$19.95





**CaliTuff® Cord**

Our highly durable CaliTuff® Cord is made of braided, PVC-jacketed material that resists cutting and chewing. Includes a reinforced earcup entry point that resists stress separation. Cable management is made easy with a tethered hook and loop strap.



**NEW**

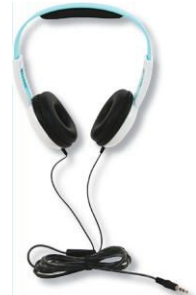

**Califone® KH-08 Pre-K On-ear Headphones**

Constructed for the littlest of listeners, these headphones are perfect for Pre-K aged children. The CaliTuff® cord and strong but flexible plastic headband will withstand the rough and tumble usage expected of this age group.

- On-ear cups
  - Foam-filled, leatherette ear pads
  - 6 foot CaliTuff® cord
  - Adjustable headband is made of plastic with padding at that top for added comfort
  - 3.5mm stereo plug
  - Available with convenient inline volume control
- 3 year warranty  
Available March 2023



Item #	Model Number	Plug Type	Color	Quantity	List Price
5-2104621-670	KH-12 BK	3.5mm	Black/Red	Each	\$12.95
5-2104608-670	KH-12 WH	3.5mm	Light Blue/White	Each	\$12.95
<b>With Inline Volume Control</b>					
5-2104622-670	KH-12V BK	3.5mm	Black/Red	Each	\$15.95
5-2104618-670	KH-12V WH	3.5mm	Light Blue/White	Each	\$15.95



**HamiltonBuhl® Flex-Phones™ Headphones**

- EVA is a safe, non-toxic, BPA free, soft, flexible and most indestructible product
- Flex-Phones are certified for all major USA and International child safety testing standards. Recommended for children ages 3 and up
- Flex-Phones grow with the children that use it, for smaller children just snap on the extension band for a snugger fit
- Drivers: 30 mm, Impedance: 32 ohms, Frequency Response: 20-20000Hz Sensitivity: 82dB +/- 3dB, 4 foot cord
- Recommended for children ages 3 and up
- **1 Year Warranty**

Item #	Model Number	Plug Type	Color	Quantity	List Price
5-1530559-670	KIDS-BLK	3.5mm	Black	Each	\$43.95
5-1533624-670	KIDS-BLU	3.5mm	Blue	Each	\$43.95
5-1533625-670	KIDS-RED	3.5mm	Red	Each	\$43.95
5-1577115-670	KIDS-PPL	3.5mm	Purple	Each	\$43.95
5-1577116-670	KIDS-GRN	3.5mm	Green	Each	\$43.95







**CaliTuff® Cord**

Our highly durable CaliTuff® Cord is made of braided, PVC-jacketed material that resists cutting and chewing. Includes a reinforced earcup entry point that resists stress separation. Cable management is made easy with a tethered hook and loop strap.

**Califone® 3060 Lightweight On-ear Headphones**

We've ramped up the value and strength of our 3060 lightweight headphones by replacing the standard cord with a 6 foot CaliTuff® cord. Features foam-filled leatherette ear pads for elevated comfort and durability.

- On-ear cups
- Foam-filled, replaceable, leatherette ear pads
- 6 foot CaliTuff® cord
- Plastic headband is fully adjustable to fit most children and adults
- 3.5mm stereo plug

90 day warranty  
Available March 2023



Item #	Model Number	Color	Quantity	List Price
5-2103816-670	3060AVS CT	Silver	Each	\$12.95
<b>Replacement Ear Pads</b>				
5-335819-670	EP-306X	Black	1 Pair	\$2.65

**Califone® CA-2 Lightweight On-ear Headphones**

The CA-2 Headphones are lightweight with foam earpads that are replaceable for high usage environments.

- On-ear cups
- Noise-reducing, foam ear pads
- 5.5 foot, standard straight cord
- 3.5mm stereo plug
- Adjustable, plastic headband suitable for children or adults
- Earcups swivel to lay flat for easy storage
- Heavy-gauge zippered, plastic bag with personalized label area
- 90 day warranty



Item #	Model Number	Color	Quantity	List Price
5-2104607-670	CA-2 BLACK	Black	Each	\$9.25
<b>Replacement Foam Ear Pads</b>				
5-1543921-670	EP-CA2	Black	Each	\$2.65

**Califone® 3065 Lightweight On-ear Headset**

3065AVT is the perfect lightweight, on-ear headset for distance learning, computer labs, language learning applications and more. The omni-directional microphone includes a foam wind-shield for clear communication.

- On-ear cups
  - Bendable, gooseneck microphone with wind shield
  - Noise-reducing, foam ear pads that are replaceable
  - 6 foot, standard straight cord
  - 3.5mm stereo plug
  - Adjustable, plastic headband suitable for children or adults
  - Earcups swivel to lay flat for easy storage
- 90 day warranty



Item #	Model Number	Color	Quantity	List Price
5-1543848-670	3065AVT	Black	Each	\$16.95
<b>Replacement Foam Ear Pads</b>				
5-1543921-670	EP-CA2	Black	Each	\$2.65

**Cables2Go 1/4 Inch Stereo Male to 3.5mm Female Adapter**

Convert a 3.5mm stereo plug to connect to a 1/4 inch jack. Connector is a 3.5mm female jack.

- Nickel plated contacts
- Carries a stereo audio signal
- TAA compliant



Item #	Description	Color	Quantity	List Price
5-2000902-670	1/4 in male to 3.5mm female	Black	Each	\$11.95

**Cables2Go 3.5mm Stereo Male to 1/4 Inch Female Adapter**

Adapt a 1/4 inch stereo plug to connect to a 3.5mm jack. Connector is a 1/4 inch female jack.

- Nickel plated contacts
- Carries a stereo audio signal
- TAA compliant



Item #	Description	Color	Quantity	List Price
5-2000901-670	3.5mm male to 1/4 in female	Black	Each	\$11.95



**Califone® Spirit™  
1886-HL Stereo Listening Centers**

Choose from the 4 or 6 person Listening Center that offers outstanding stereo sound in portable systems. Each kit includes one 1886-HL Multimedia Player/Recorder, one Carrying Case, one 10 position Jackbox, and either four or six 3068AV Mono/Stereo Switchable Headphones.

- 1886-HL Multimedia Player/Recorder: Features stereo CD/cassette player and recorder. AM/FM radio with four speakers. SD card reader and USB connector. Headphone jack for individual and group listening. Permanently attached 5' power cord.
- 2005 Black Carrying Case: Measuring 21"L x 17"H x 10"D made of durable polypropylene. Foam-line interior for added protection. Opposing outer clasps prevent accidental opening.
- 1210AVPS Jackbox: 10 position with 1/4" inputs, 5 ft cord with dual 3.5mm and 1/4" plugs. Silver-plated contact points and individual volume control. Rugged plastic construction with skid-resistant pads and two pre-drilled holes for permanent mounting.
- 3068AV Mono/Stereo Switchable Over-ear Headphones: Foam-padded, replaceable earcushions, 3.5mm plug with snap-on 1/4" adapter, 10' cord, volume control on each ear cup. Adjustable padded headband.

Item #	Description	Model Number	Headphone Jack	List Price
5-1544127-670	6 Person Center	1886PLC-6	3.5mm	\$292.95
5-1544126-670	4 Person Center	1886PLC	3.5mm	\$266.95



**Califone® 1216BKBT Bluetooth® Jackbox**

Stream audio from any Bluetooth® enabled device to this 6 position Jackbox. Pairing is easy, simply scan for devices and select Califone 1216BKBT.

Instructions included.

- Six positions with 3.5mm headphone inputs
- 3.5mm Daisy-chain capable for adding more listeners
- Silver-plated contact points
- Individual volume control
- Internal, rechargeable battery supports up to 12 hours playtime when fully charged
- Includes USB charging port with power adaptor
- Multi-function touch button controls the power (on/off) and pause/play
- LED indicators provide device status
- 3.5mm input jack for non-Bluetooth® use
- 1 year warranty

Item #	Description	Model Number	Headphone Jack	List Price
5-1609578-670	6 Position Bluetooth® Jackbox	1216BKBT	3.5mm	\$59.95



**Califone® Standard Jackboxes**

All Califone® jackboxes feature silver-plated contact points and individual volume control. Made of durable plastic with skid-resistant pads and two pre-drilled holes for permanent mounting.

- 1218AV-PV: 8 position with 1/4" inputs, 5 ft cord with dual 3.5mm and 1/4" plugs
- 1210AVPS: 10 position with 1/4" inputs, 5 ft cord with dual 3.5mm and 1/4" plugs
- JB310: 10 position with 3.5mm inputs, 6 ft cord with dual 3.5mm and 1/4" plugs, 3.5mm daisy chain input
- 1210T: 10 position with 3.5mm inputs for headphones or headsets allows for 2 way communication, 6 ft cord with 3.5mm plug, 3.5mm daisy chain input
- 1 year warranty

Item #	Description	Model Number	Headphone Jack	Quantity	List Price
A 5-060086-670	8 Position	1218AV-PY	1/4 in	Each	\$19.95
B 5-1543840-670	10 Position	1210AV-PS	1/4 in	Each	\$26.95
C 5-1543900-670	10 Position w/Daisy Chain	JB310	3.5mm	Each	\$31.95
D 5-1466302-670	2-Way 10 Position	1210T	3.5mm	Each	\$39.95



**Califone® Listening First™ 1114 Jackboxes**

This mini-jackbox measures 1.5"H x 3.25"L x 3.25"D and provides stereo sound to four positions.

- Four 3.5mm listening positions
- Silver-plated contacts prevents crackling when connected with other jackboxes.
- Individual volume control for customized preferences
- 3.5mm stereo plug with detachable 6' patch cord connects with media players
- Made of rugged ABS plastic
- Four 1/4" skid-resistant rubber pads limits movement when in use

1 year warranty  
Create your own colorful listening center using Listening First Headphones, shown on page 1002!

Item #	Description	Model Number	Headphone Jack	Quantity	List Price
5-1543834-670	Yellow	1114-YL	3.5mm	Each	\$19.95
5-1543835-670	Blue	1114-BL	3.5mm	Each	\$19.95
5-1543836-670	Red	1114-RD	3.5mm	Each	\$19.95



**Minolta® MN67Z FHD Bridge Camera**

- The MN67Z packs a punch with it's powerful 67x optical and 4x digital zoom capabilities.
- The built-in WiFi lets you easily connect to your smartphone to transfer your photos.
- 27 intelligent shooting modes including: Night Portrait, Panorama, and Sunset.
- Includes a SD/SDHC memory card slot with 16GB SDHC card to store extra photos.

Item #	Model Number	Battery Size	Quantity	List Price
5-2090317-670	MN67Z-BK	Lithium Ion	Each	\$1,014.95

**Minolta® MN53Z FHD Bridge Camera**

- 16 MP stills and 1080p HD videos for high quality content.
- Key features include: WiFi connectivity, 53x zoom lens with optical stabilization, 460k 3.0 in LCD display, and a variety of shooting modes and scene modes that complement any setting.

Item #	Model Number	Battery Size	Quantity	List Price
5-2090319-670	MN53Z-BK	Lithium Ion	Each	\$852.95



**Nikon® D7500 Digital Camera**

- It includes the AF S DX NIKKOR 18 140mm f/3.5 5.6G ED VR lens, which is optimized for Nikon's high resolution DX format image sensors.
- The lens offers a versatile 7.8x zoom range, and Nikon's VR image stabilization for blur free handheld shooting.
- Capture everything from wide angle landscapes and family portraits to telephoto close ups.

Item #	Model Number	Battery Size	Quantity	List Price
5-2104678-670	1582	Lithium Ion	Each	\$3,347.95

**Nikon® Z 50 Mirrorless Camera**

- The 16 50mm VR lens kit pairs the small but mighty Z 50 with the smallest Nikon DX lens ever, the NIKKOR Z DX 16 50mm f/3.5 6.3 VR.
- The NIKKOR Z DX 16 50mm f/3.5 6.3 VR lens offers a versatile zoom range of 16 50mm, with Vibration Reduction (VR) image stabilization built into the lens; and quiet operation, making it ideal for video as well as still images.

Item #	Model Number	Battery Size	Quantity	List Price
5-2104691-670	1633	Lithium Ion	Each	\$2,226.95



**Nikon® Z fc Mirrorless Camera**

- 4K videos with full time Eye Detection AF.
- A flip out vlogger screen with live streaming capabilities.
- Small size with big image quality.

Item #	Model Number	Battery Size	Quantity	List Price
5-2104685-670	1675	Lithium Ion	Each	\$2,454.95



**Brother® HL-L6200DWT Laser Printer**

Monochrome laser printer offers fast print speeds up to 48 pages per minute at 1200 x 1200 dpi for workgroups with higher print volumes. Backlit LCD makes navigating through the menu options fast and simple. Advanced security features help restrict unauthorized printing and protect your sensitive documents. Dual, 520-sheet input tray with 50-sheet multipurpose tray let you easily print envelopes and alternative media types. Automatic duplex printing allows you to quickly print two-sided documents to reduce paper consumption. Built-in wireless and Ethernet network interfaces enable you to share this printer with multiple users on your network.

- This printer is compatible with our toner items 1534087, 1534086 and 1534088.



Item #	Model Number	Resolution	Warranty	Quantity	List Price
5-1538684-709	HL-L6200DWT	1200 x 1200 dpi	1 YEAR LIMITED	Each	\$1,016.95

**Brother® HL-L6200DW Laser Printer**

Monochrome laser printer offers fast print speeds up to 48 pages per minute at 1200 x 1200 dpi for workgroups with higher print volumes. Backlit LCD makes navigating through the menu options fast and simple. Advanced security features help restrict unauthorized printing and protect your sensitive documents. 520-sheet input tray with 50-sheet multipurpose tray lets you easily print envelopes and alternative media types. Automatic duplex printing allows you to quickly print two-sided documents to reduce paper consumption. Built-in wireless and Ethernet network interfaces enable you to share this printer with multiple users on your network.



Item #	Model Number	Resolution	Warranty	Quantity	List Price
5-1538683-670	HL-L6200DW	1200 x 1200 dpi	1 YEAR LIMITED	Each	\$724.95

**HP® M652DN Color LaserJet Printer**

Color LaserJet printer with a 2.7 inch LCD combines exceptional performance and energy efficiency with professional-quality documents, all while protecting your network with top of the line security. With HP Sure Start, this printer regularly checks its operating code and repairs itself from attempted hacks to help prevent potential attacks. Its fast start time wakes up quickly and prints your first page in as little as 8.4 seconds for time-saving performance. Advanced design is compatible with high-yield, color toner cartridges with JetIntelligence (sold separately) to get the most out of your prints. Centralize control of your printing environment with Web Jetadmin and help build business efficiency with confidence. Printer also features 1GB memory, 1.2 GHz processor speed, 100-sheet multipurpose tray, 550-sheet input tray, 500-sheet output bin, automatic dual-sided printing and more.



Item #	Model Number	Resolution	Warranty	Quantity	List Price
5-1599885-670	M652dn	1200 x 1200 dpi	1 YEAR LIMITED	Each	\$3,996.95

**Brother® HL-L5200DWT Business Laser Printer**

Monochrome laser multifunction copier helps improve office productivity with fast print and copy speeds of 42 pages per minute at up to 1200 x 1200 dpi. Backlit LCD makes navigating through the menu options fast and simple. Advanced security features help restrict unauthorized printing and protect your sensitive documents. 250-sheet and 520-sheet paper trays plus a 50-sheet multipurpose tray provide an 820-sheet total paper capacity. Automatic duplex printing allows you to quickly print two-sided documents to reduce paper consumption. Built-in wireless and Ethernet network interfaces enable you to share this printer with multiple users on your network.

- This printer is compatible with our toner items 1273494 and 1273491.



Item #	Model Number	Resolution	Warranty	Quantity	List Price
5-1538682-670	HL-L5200DWT	1200 x 1200 dpi	1 YEAR LIMITED	Each	\$1,146.95

**Brother® HL-L3290CDW Compact Laser Printer**

Digital color printer with copying and scanning is a great choice for home or small offices. Quick print speeds up to 25 pages per minute accommodate the varied printing needs for busy locations. Manual feed slot can handle a variety of paper sizes and types, including cardstock, envelopes and more. Connect with versatile options including built-in wireless or USB interfaces and print wirelessly from mobile devices. The 250-sheet capacity, adjustable paper tray helps improve efficiency with fewer refills and handles letter-size or legal-size paper. Plus, it's compatible with Brother Genuine high-yield replacement toner cartridges (sold separately) to help minimize your printing costs.



- This printer is compatible with our toner items 2049151, 2008873, 2008874, 2008876, 2008877, 2008879, 2008878, 2008880, 2008881 and 2049146.

Item #	Model Number	Resolution	Warranty	Quantity	List Price
5-2006928-670	HL-L3290CDW	2400 x 600 dpi	1 YEAR LIMITED	Each	\$956.95

**HP® M653DN Color LaserJet Printer**

Color LaserJet printer with a 4.3 inch touch-screen display combines exceptional performance and energy efficiency with professional-quality documents, all while protecting your network with top of the line security. With HP Sure Start, this printer regularly checks its operating code and repairs itself from attempted hacks to help prevent potential attacks. Its fast start time wakes up quickly and prints your first page in as little as 5.7 seconds for time-saving performance. Advanced design is compatible with high-yield, color toner cartridges with JetIntelligence (sold separately) to get the most out of your prints. Centralize control of your printing environment with Web Jetadmin and help build business efficiency with confidence. Printer also features 1GB memory, 1.2 GHz processor speed, 100-sheet multipurpose tray, 550-sheet input tray, 500-sheet output bin, automatic dual-sided printing and more.



Item #	Model Number	Resolution	Warranty	Quantity	List Price
5-1599886-670	M653dn	1200 x 1200 dpi	1 YEAR LIMITED	Each	\$5,538.95

Visit our website for more iPad Cases



### Gumdrop® FoamTech™ iPad Carrying Case

- Lightweight yet rugged FoamTech case that features a handy handle that can also be folded for viewing and typing modes.
- FoamTech allows access to all ports and buttons, as well as the camera and speakers.
- The back of the case features a window cut-out for easy asset tagging.
- The case is designed to accommodate the Apple Pencil and other third-party styluses.

Item #	Description	Model Number	Quantity	List Price
5-2039861-670	7th, 8th, 9th Gen.	02A002	Each	\$86.95



**NEW**

### iBank® 10.2" Protective Rugged iPad Case

- 3 layer heavy duty bumper case, combined with 1 layer flexible silicone and 2 layer hard PC linings as well as built-in screen protector, providing full body protection of your iPad against accidental drops, scratches, shocks, bumps and dirt. Rotatable Kickstand and Hand Strap.
- The Rotatable and Adjustable Hand Strap makes you hold or use your device easier in all directions.
- Also designed with a Pen Holder to grab your Apple Pen whenever you want, easily to carry your Apple pen with your device.

Item #	Description	Model Number	Quantity	List Price
5-2104688-670	Black	iP1019-BP2-BLK	Each	\$66.95
5-2104692-670	Red	iP1019-BP2-RD	Each	\$66.95
5-2104684-670	Blue	iP1019-BP2-BLU	Each	\$66.95

### Supersonic® Munchkins Android Tablet

- Supersonic Munchkinz SC-774KT 7 Inch Kids Tablet. 4 GB of memory and Android 5.1 Lollipop operating system.
- Has four directional rotating capacitive multi-touch screen with 1024-600 resolution. Processor: ARM Cortex A7 RK3126B quad-core 1.3 GHz processor.



Item #	Description	Model Number	Screen Size	Wi Fi	List Price
5-1562827-670	7 in Android Tablet	SC-774KT	7 in	Yes	\$256.95



**NEW**

### iBank® 10.2" Shockproof iPad Case

- Rugged, Three Layer Protective Case with Polycarbonate Hard Shell Exterior and Flexible TPU inner core protecting against sudden drops and falls.
- Provides a perfect protection for your tablet against shocks, damages, dust and scratches.
- Precise cut and design allow easy access to all ports, sensors, speakers, cameras.

Item #	Description	Model Number	Quantity	List Price
5-2104679-670	Black	iP1019-SP11-BLK	Each	\$66.95
5-2104680-670	Red	iP1019-SP11-RD	Each	\$66.95
5-2104693-670	Blue	iP1019-SP11-BLU	Each	\$66.95



**NEW**

### iBank® 10.2" iPad Case w/ Hand Strap

- A built in Pencil holder for Pen securely carrying, BUT Apple Pencil is not included.
- This iPad case is made of premium hard plastic and soft silicone, belong to heavy duty rugged case, the three layer structure provides good protection from drop and impact.
- Precise cutout design, easy to access all features without removing cases.

Item #	Description	Model Number	Quantity	List Price
5-2104690-670	Black	iP1019-BI-BLK	Each	\$66.95
5-2104694-670	Red	iP1019-BI-RD	Each	\$66.95
5-2104697-670	Blue	iP1019-BI-BLU	Each	\$66.95

### Logitech® Keys-To-Go Portable Bluetooth Keyboard

- Unique layout and iOS shortcuts provide a familiar, fast and accurate typing experience.
- Rechargeable, three-month battery has an indicator to show when the charge is low to prevent sudden battery depletion.
- Bluetooth technology eliminates the need for wires for simple use.



Item #	Description	Model Number	Quantity	List Price
5-1536328-670	Standalone iPad Keyboard	920-006701	Each	\$174.95



**iBank® Zippered Neoprene Chromebook Case**

- The neoprene sleeve case fits any 11 or 13 inch laptop or tablet device.
- It's durable neoprene exterior is waterproof and will protect your device from bumps, scratching and impact damage.

Item #	Description	Quantity	List Price
5-2068169-670	11 in Zippered Case Black	Each	\$23.95
5-2068167-670	11 in Zippered Case Blue	Each	\$23.95



**Belkin™ Notebook Sleeve**

- Belkin Sleeve designed to carry Laptops, chromebooks, and tablets safely to and from the classroom day after day.

Item #	Description	Model Number	Quantity	List Price
5-1554442-670	11 in Sleeve, Red	B2B081-C02	Each	\$28.95



Dewey the Document Camera Stand



**Allsop® Headset/Tablet Stand with Headphone Storage**

- Measures 9-1/2 x 3-1/2 x 8 Inches
- Stores and protects headset while keeping it accessible
- Manages cables and charging cords
- Holds most tablets and phones with 4 adjustable angles for optimum viewing
- Designed for headphones up to 8 inches in height

Item #	Description	Quantity	List Price
9-1599735-670	Headset/Tablet Stand	Each	\$33.29



**Tripp Lite® Lightning iPhone/iPad Charger Cables**

- Cables are MFI Certified, so they are made for use with iPhone (5, 5c, 5s, 6, 6 Plus, 6s, 6s Plus, SE, 7, 7 Plus, 8, 8 Plus, X, XR, XS, XS Max), iPad (4th, 5th and 6th generations), iPad mini, iPad mini 2, iPad mini 3, iPad mini 4, iPad Air, iPad Air 2, iPod Touch (5th and 6th generations), iPad Pro 12.9 inch (1st and 2nd generations), iPad Pro 10.5 inch and iPad Pro 9.7 inch.

Item #	Color	Size	Quantity	List Price
9-2024503-670	White	6 ft	Each	\$47.99
9-2024525-670	White	10 ft	Each	\$61.29
9-2024537-670	White	36 in	Each	\$39.99



**Copernicus® Dewey the Document Camera Stand**

Turn your iPad® into a document camera!

- Spring loaded clamp fits all versions of iPad® with a camera and various smartphones with or without a case (excludes 12.9" iPad® Pro)
- 90 degree rotating mount that swivels and tilts, keeping the iPad® secure
- Lightweight and height adjustable
- Useful as an iPad® stand on desks or other flat surfaces
- Frame measures 10-3/4" W x 15" D x 12-3/4 – 23" H (lowest to highest position)
- 5 Year Frame Warranty

Item #	Description	Product Dimensions	List Price
5-1530117-670	Stand for iPad/iPad Mini	10-3/4W x 15D x 12-3/4-23H in	\$114.95
5-1530118-670	Stand w/ Microscope and Light	10-3/4W x 15D x 12-3/4-23H in	\$130.95



**KwikBoost products include free custom artwork**



**KwikBoost Standard Floor Stand Charging Station**

KwikBoost's flagship product, the Standard Floor Stand charging station is strong, simple and sleek. The most widely used charging station on the market, it's designed for high traffic environments. The solution charges 8 devices simultaneously, all at full speed. With the addition of the wireless charging ledge, it can charge 10 devices at the same time. Backed by a Lifetime Warranty and a 1-year service plan, the station is perfect for universities, schools, libraries, offices and more.

Item #	Description	Product Dimensions	List Price
5-2027591-670	Standard Charging Station	18 W x 15 D x 48 H in	\$1,527.95
5-2027592-670	Ledge Accessory	-	\$679.95



**KwikBoost Wall Mount Charging Station**

The standard wall mounted charging station is affordable, easy to use, and built from commercial grade durable materials. The wall mounted version of the most popular charging station saves space while providing the same functionality. The station charges 8 devices simultaneously, all at full speed. When paired with the wireless charging ledge, it can charge 10 devices at the same time. Backed by a Lifetime Warranty and 1-year service plan, it's a perfect solution for universities, schools, libraries, stadiums, offices, and more.

Item #	Description	Product Dimensions	List Price
5-2027594-670	Wall Mount Station	18 W x 3 D x 9 H in	\$1,090.95
5-2027592-670	Ledge Accessory	-	\$679.95



**KwikBoost Multi-Device Charging Locker**

KwikBoost's multi-device charging locker provides safe and secure charging for laptops, tablets, and phones. With larger bays than the phone locker, optional outlets, and USB ports, this solution charges any device on the market. Keypad locks with user-generated codes and easy set up make this a great fit for a multitude of environments, including schools, libraries, offices and more. 8 bays. And as with all KwikBoost products, the multi-device charging locker comes with the KwikBoost Lifetime Warranty.

Item #	Description	Product Dimensions	List Price
6-2027595-670	Charging Locker	24 W x 24 D x 63 H in	\$12,016.95

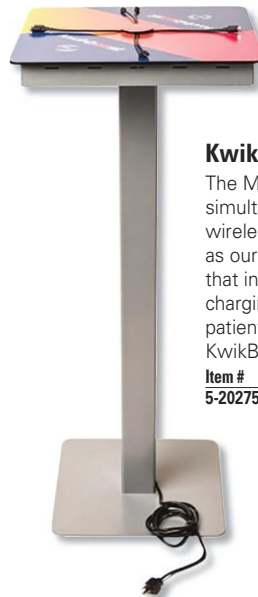

**KwikBoost Mini Power Table**

The Mini Power Table charges up 8 devices simultaneously, all at full speed, and features optional wireless charging. It provides the same functionality as our floor stand solutions, but in a convenient table that invites people to gather and collaborate while charging. It's the perfect solution to serve students, patients, travelers, and patrons. Backed by the KwikBoost Lifetime Warranty and 1-year service plan.

Item #	Description	Product Dimensions	List Price
5-2027596-670	Power Table	18 W x 18 D x 42 H in	\$2,183.95

**KwikBoost Mini Charging Hub Table Top**

The table top version of the Kwikboost Mini Charging Hub is a compact and convenient charging solution for any table or counter surface. Ultra-affordable, the station is built for high volume use and can charge up to 4 phones, all at full speed. It's perfect for dorm rooms, patient rooms, library tables, and more.

**Features:**

- 5V 2.4 A per port
- Cable configuration: 2 lightning, 1 micro, 1 type C
- Unit dimensions: 5.5 in x 5.5 in x 1.75 in
- Unit weight: 2 lbs
- Certified: MRi, USB, FCC



Item #	Description	Product Dimensions	List Price
5-2041035-670	Kwikboost Mini Charging Hub	5-1/2 x 5-1/2 x 1-3/4 in	\$283.95

# LUXOR

**kwikboost**  
EDGEPOWER™

## Desktop Charging Station

The cordless power solution for today's dynamic learning environments. Luxor's KwikBoost EdgePower is an innovative new battery-powered charging station that easily clamps onto the edges of desks, tables, and other standard surfaces.



Rechargeable Battery  
KBEP-BAT



Single Battery Charger  
KBEP-BASE1



3-Bay Base Charger System  
KBEP-BASE3



9-Bay Base Charger System  
KBEP-BASE9

Adjustable clamp is compatible with common desk and tabletop surfaces

Swappable battery makes it a snap to recharge

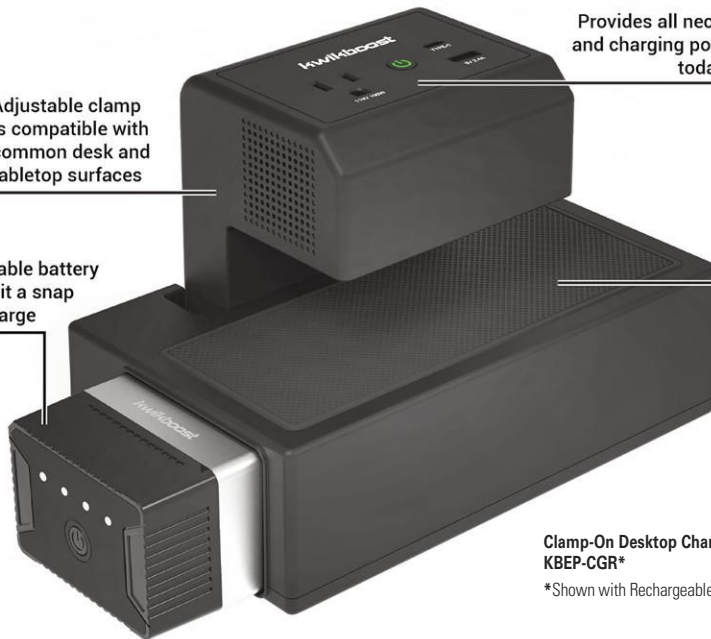

Provides all necessary outlets and charging ports required by today's electronics

Textured desktop grip

Clamp-On Desktop Charging Unit:  
KBEP-CGR\*

\*Shown with Rechargeable Battery: KBEP-BAT

Item #	Description	List Price
5-2026970-670	2 Rechargeable batteries	\$663.95
<b>Personal Use Bundle</b> KBEP-2B13C1	1 Clamp-on Desktop Charging 1 Single Battery Charger	
6-2026971-670	3 Rechargeable batteries	\$1,571.95
<b>Light Use Bundle</b> KBEP-3B3C1	3 Clamp-on Desktop Charging Unit 1 3-Bay Base Charging Station	
6-2026962-670	6 Rechargeable batteries	\$2,302.95
<b>Medium Use Bundle</b> KBEP-6B3C1	3 Clamp-on Desktop Charging Unit 1 3-Bay Base Charging Station	
6-2026967-670	9 Rechargeable batteries	\$3,912.95
<b>Heavy Use Bundle</b> KBEP-9B6C9	6 Clamp-on Desktop Charging Unit 1 9-Bay Base Charging Station	
6-2026964-670	12 Rechargeable batteries	\$4,640.95
<b>Constant Use Bundle</b> KBEP-12B6C9	6 Clamp-on Desktop Charging Unit 1 9-Bay Base Charging Station	





**Luxor® LuxPower AC and USB Charging Tower**

- The LuxPower Mobile AC and USB Charging Tower ensures that outlets for electronic devices are always in easy reach.
- This mobile and versatile surge protector tower is perfect for classrooms, conference centers, co-working spaces, offices and anywhere else that mobile power is vital.
- 1 year limited warranty.

Item #	Description	Product Dimensions	List Price
5-2087591-670	LuxPower AC USB Charge Tower	14 W x 14 D x 40 H in	\$623.95



**Oklahoma Sound® Duet Charging Cart**

- A max of 32 laptops and tablets with screens up to 15.6" (1" thickness) can be stored and charged.
- 2 UL approved power strips offering a total of 32 outlets with one simple 12ft power cord.
- Heavy-duty 4" casters (2 locking) and a sturdy handle allows for safe and easy movement. Duet, where universal storage and charging meet!

Item #	Description	Product Dimensions	Color	List Price
6-2021556-670	Charging and Storage Cart	28 1/8"W x 22"D x 38 1/4" H	Gray Base	\$1,319.95



**Classroom Select® Mobile Power Tower**

- Get instant charging access for Chromebooks, smart phones, tablets, and other mobile devices with these versatile charging towers.
- Towers are easily mobile on four dual-wheel casters (two locking).
- Provides charging capacity through a single 3-prong plug.
- Includes two AC outlets and two USB outlets on each of four sides, for a total of eight each.
- The rechargeable tower is cord free and includes four USB-C and eight USB-A ports.
- It comes with one battery but has space for three. Expand battery capacity by purchasing two extra batteries to enjoy longer times between charges.



Item #	Description	Product Dimensions	List Price
6-1576748-670	Power Tower w/Cord	17-1/2 W x 17-1/2 D x 40 H in	\$532.95
6-5009856-670	Wireless Power Tower	12 W x 12 D x 28-1/4 H in	\$2092.95



**MooreCo™ Clamp Mount Outlet and USB Charger**

The Clamp Mount Outlet & USB Charger will add instant convenient AC power and USB charging accessibility to your desktop.

- Keep your laptops, tablets, phones, or other mobile computing devices charged and ready to go at your desk, in your conference room, or anywhere else power access is needed.
- Adjusts to fit a desktop from .75" to 2" thick.
- Includes three AC outlets, two USB charging ports, and a 10' power cord.
- Handy lip can be used as a tablet stand. Accommodates the Otterbox Defender case with cover!
- UL/cUL listed. Tested for UL 962A (furniture power distribution).

Item #	Description	Product Dimensions	List Price
9-1576749-670	Clamp Mount with Charger	7-1/4 W x 3 D x 5-1/4 H in	\$138.95





Visit our website for 8th generation iPad Tech Tubs.



**Copernicus Premium Tech Tub2®**

Holds iPads®, Chromebooks or a combination of both. Ergonomic handles on the door and top. The flip-up handle on the top makes this easy to carry.

- Adjustable shelves - Internal cable organizers - 6 or 10 outlet internal power strip.
- Cable management hooks on back
- 3-point door lock with 2 keys
- Lifetime Warranty



Item #	Description	Product Dimensions	List Price
<b>Standard</b>			
5-1566449-670	Holds 6 Devices	12-1/2 Wx16-1/4 Dx16-1/2 H in	\$386.95
5-1566450-670	Holds 10 Devices	12-1/2 W x 16-1/4 D x 26 H in	\$626.95
5-1566451-670	Holds 10 Devices with USB	12-1/2 W x 16-1/4 D x 26 H in	\$796.95

**Copernicus Tech Tub2® Trolley**

Trolley has an adjustable handle, ideal for transporting small quantities of devices. Also has 3" durable casters for easy movement.

Includes Tech Tub 2® with:

- Adjustable shelves - Internal cable organizers - 6 or 10 outlet internal power strip.
- Cable management hooks on back
- 3-point door lock with 2 keys
- Lifetime Warranty



Item #	Description	Product Dimensions	List Price
<b>Standard</b>			
5-1566452-670	Trolley Holds 6 Devices	14-3/4 Wx19-1/2 Dx35-3/4 H in	\$451.95
5-1566453-670	Trolley Holds 10 Devices	14-3/4 Wx19-1/2 Dx35-3/4 H in	\$718.95
5-1566454-670	Holds 10 Devices with USB	14-3/4 Wx19-1/2 Dx35-3/4 H in	\$950.95

**Copernicus Tech Tub2® Modular Cart**

Modular Cart has two handles for ease of mobility. Top tubs break apart using clips, ideal for sharing small sets of devices. For the 32 device models the lower tub sets are permanently connected together.

- Power timer for charging – requires 1 outlet
- 4" locking casters
- Individual tubs can be locked together for added security Includes Tech Tub 2® with:
- Adjustable shelves - Internal cable organizers - internal power
- Cable management hooks on back
- 3-point door lock with 2 keys per Tub
- USB Model Only, includes 4 - 10 port syncing USB hubs for a variety of devices

Item #	Description	Product Dimensions	List Price
<b>Standard</b>			
6-1566455-670	Modular Cart Holds 24 Devices	34W x 19D x 43H in	\$2,127.95
6-1566456-670	Cart Holds 24 Devices with USB	34W x 19D x 43H in	\$3,015.95
6-1566457-670	Modular Cart Holds 32 Devices	34W x 19D x 50H in	\$2,556.95
6-1566458-670	Cart Holds 32 Devices with USB	34W x 19D x 50H in	\$3,591.95



**Copernicus Original Tech Tub® Premium**

The Original Tech Tub™ has the capability to charge Chromebooks, or other tablets. It makes sharing small sets of devices easy within a classroom or throughout a school. Adjustable dividers can accommodate most cases and the side cable pocket/channel helps keep cords neat, tidy, and lined up with each device. Tech Tub includes 2 padlocks same keys, and locking block and pin to secure the tub to a flat surface. Tech Tubs are made from highly durable, heat resistant ABS plastic, and are vented to ensure airflow.

Original Tech Tub™ Premium for 6 devices:

- Internal six outlet power strip
- NEW taller lid accommodates Chromebooks (14"H x 9" W x or smaller)

Original Tech Tub™ Premium for up to 10 devices

- 10 Port USB sync/charge hub
- USB hub can be mounted internally or externally to support up to 10 devices in one tub (depending on the size of your device and case)

Item #	Description	Product Dimensions	List Price
<b>Standard</b>			
5-1530106-670	Holds 6 Devices	12-1/2W x 16D x 16H in	\$292.95
6-1528001-670	Holds 10 Devices	12-1/2W x 16D x 14H in	\$564.95

**Copernicus Tech Tub® Standard**

For many classrooms, their device security system is simply locking the door at the end of the day. This new mid-range, top loading model is ideal for these environments and at a lower cost than our premium models. It has all the features of the premium models, including a padlock for securing the devices inside. The only difference is there is no locking block and pin to secure the tub to surfaces. Tech Tub Standard has the capability to charge up to 6 devices. It makes sharing small sets of devices easy within a classroom or throughout a school. Adjustable dividers can accommodate most cases and the side cable channel helps keep cords neat, tidy and lined up with each device.

Item #	Description	Product Dimensions	List Price
<b>Standard</b>			
5-2009450-670	Tech Tub - Holds 6 Devices	12-1/2W x 16D x 16H in	\$211.95



# Tech Tub2<sup>®</sup>

Holds iPads<sup>®</sup> and Chromebooks<sup>™</sup>



Fits your devices. Suits your budget. Goes where you go.

UV Tech Tub for sanitizing devices and more—and in one minute!

Top compartment holds package of 12 medical grade testing cards to check UVC level (monthly check is recommended)

Bulbs emit proper wavelength level required to disinfect and are easy to replace by educators. Bulbs are rated for 11,000 hours of use.

360 degrees of UVC irradiance to maximize disinfection with 4 bulbs and reflective interior

Large enough to hold open laptops to disinfect the most germ-y surfaces: the screen and keyboard



Enclosed disinfection chamber (no UVC exposure to user)  
The UV bulbs turn on only when the door is closed securely and start button is pushed



UVC filtering window (to check the bulbs are working)

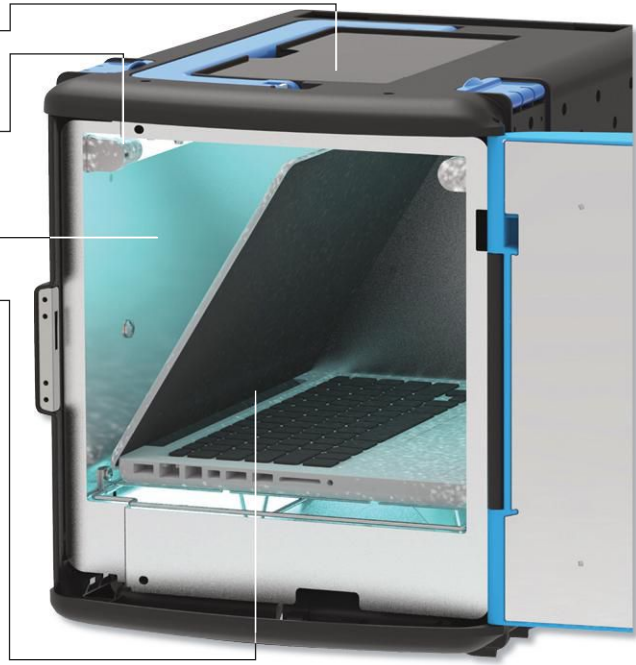

## Copernicus Tech Tub2<sup>®</sup> UV

The large chamber can disinfect\* laptops (when open), VR headsets, headphones, robotics and other commonly used classroom items. The UV Tech Tub is here to help with the necessary disinfecting of devices required to keep classrooms as germ-free as possible.

- Fully enclosed disinfection chamber (no UVC exposure to user)
- Small footprint and can clip onto existing Tech Tub2 Trolleys and Modular Carts



Item #	Description	Product Dimensions	Color	List Price
5-2040933-670	UV Tech Tub	11-3/4" W x 17" D x 13" H in	Black/Blue	\$1,166.95

\*As with all UV disinfection technology, many, but not all viruses and germs are killed in the process.

## Copernicus Tech Tub2<sup>®</sup> Modular Carts with UV Tub

In one minute, disinfect devices, including laptop screens and keyboards! Tech Tub2 Modular Carts now include options which have a UV Tech Tub to create a complete device charging, storing and disinfecting solution. To encourage physical distancing, the tubs unclip from the cart and can be placed around the classroom.

- Modular Carts have 4" locking casters

Item #	Description	Product Dimensions	List Price
6-2040945-670	Modular Cart Holds 18 Devices	34W x 19D x 43H in	\$2,899.95
6-2040940-670	Cart Holds 18 Devices with USB	34W x 19D x 43H in	\$3,952.95
6-2040939-670	Modular Cart Holds 26 Devices	34W x 19D x 50H in	\$3,310.95
6-2040938-670	Cart Holds 26 Devices with USB	34W x 19D x 50H in	\$4,296.95

## Copernicus Tech Tub2<sup>®</sup> Trolleys with UV Tub

In one minute, disinfect\* devices, including laptop screens and keyboards! Our popular Tech Tub2 Trolleys now include options which have a UV Tech Tub to create a complete device charging, storing and disinfecting solution. The green tub stores, charges and locks up small sets of iPads<sup>®</sup>, 11" Chromebooks<sup>™</sup> and other tablets and the blue tub disinfects them. The large UV chamber of the blue tub disinfects laptop keyboards and screens (when open), VR headsets, headphones, robotics and other commonly used classroom items.

- Durable 3" casters



Item #	Description	Product Dimensions	List Price
5-2040943-670	Trolley Holds 6 Devices	14-3/4" W x 19-1/2" D x 35-3/4" H in	\$1,698.95
5-2040934-670	Trolley Holds 10 Devices	14-3/4" W x 19-1/2" D x 36-3/4" H in	\$1,924.95
5-2040941-670	Trolley Holds 10 Devices w/USB	14-3/4" W x 19-1/2" D x 36-3/4" H in	\$2,166.95

\*As with all UV disinfection technology, many, but not all viruses and germs are killed in the process.





16" Height



26" Height



34" Height



42" Height

# LUXOR

## Luxor Tuffy Carts

Tuffy Carts are formed from durable, structural thermoplastic that won't warp, crack or peel. Choose from two or three shelf models, each with textured shelf surfaces and .25" retaining lips to help secure items. Comes with easy-rolling 4" ball-bearing casters, 2 locking and 2 fixed that glide over floor cracks and thresholds without effort. Electric models include a 3-outlet electrical assembly. Shelf size measures 18" x 24".

Item #	Description	Product Dimensions	Color	List Price
6-1363638-670	Tuffy Cart w/Shelf	24 W x 18 D x 16 H in	Specify	\$223.95
6-1363639-670	Tuffy Cart w/Shelf, Electric	24 W x 18 D x 16 H in	Specify	\$323.95
6-1363640-670	Tuffy Cart w/Shelf	24 W x 18 D x 26 H in	Specify	\$246.95
6-1363645-670	Tuffy Cart w/Shelf, Electric	24 W x 18 D x 34 H in	Specify	\$453.95
6-1363648-670	Tuffy Cart w/Shelf	24 W x 18 D x 42 H in	Specify	\$335.95
6-1363649-670	Tuffy Cart w/Shelf, Electric	24 W x 18 D x 42 H in	Specify	\$407.95

PLEASE SPECIFY COLOR CHOICE

### Tuffy Cart Shelf Colors

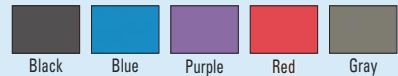

## Luxor Adjustable Height Metal AV Cart

These carts are excellent multipurpose AV/Utility Carts. Adjustable height from 24" to 42", in 2" increments. Shelves are 24" W x 18" D. Roll formed shelves with powder coat paint finish. 1/4" retaining lip around each shelf. 3-outlet, 15-foot electrical UL and CSA listed electrical assembly with cord plug snap. 4" ball bearing casters, two with locking brakes and includes safety mats. Built to last with a lifetime warranty. Model with shelf is ideal for chromebooks and keyboards. Shelf measures 18-3/4" W x 11-3/4" D.

Item #	Description	Product Dimensions	Color	List Price
6-1574547-670	Adjustable Height Metal Cart	24 W x 18 D x 24 - 42 H in	Specify	\$499.95
6-1574548-670	Adjustable Cart - Pullout Tray	24 W x 18 D x 24 - 42 H in	Specify	\$599.95

## Luxor 4 in 1 AV Cart

This versatile 4 in 1 AV cart is designed to withstand the constant demands of academic or corporate use. It's great for overhead projectors, TV sets, LCD projectors, PA systems, and more! Because this cart comes with several sets of legs, you have the ability to configure the cart to 4 different heights (15-1/2", 24-1/2", 34", and 42-1/2") to suit your particular needs. Comes with 3 shelves.

Each shelf of this adjustable height AV cart measures 18" x 24", and has a 1/4" high safety retaining lip and a textured surface to prevent sliding. A convenient 3-outlet, UL Approved, recessed electrical assembly with a 15' cord and cord wrap enhances the cart's versatility. Four 4" swivel casters (two with brakes) assure easy mobility, and the entire AV cart can hold up to 200 lbs. of evenly distributed weight.

Item #	Description	Product Dimensions	Color	List Price
6-1432728-670	4 in 1 Cart	24 W x 18 D in	Black	\$497.95

PLEASE SPECIFY COLOR CHOICE

### Luxor Cart Colors







Don't Forget the **Health Benefits** of Standing:

- Increased Heart Rate
- Burning More Calories
- Maintaining Insulin Effectiveness

Source: BBC/University of Chester research study.



**Oklahoma Sound® EduTouch Sit Stand Cart**

The EduTouch is designed to keep in mind that having the freedom to move around can help with concentration and organization of your classroom. Studies have shown that sitting for an extended period of time while working, can have a negative impact on your health. The EduTouch can accommodate technology equipment such as a laptop/chromebook or tablet, and keyboard tray. Unit rolls on two-tone double wheel hooded casters. The height can be adjusted anywhere from 27 3/4" to 44 1/2" to accommodate a wide range of comfort levels.

Item #	Top Color	List Price
6-1600680-670	Grey Nebula	\$359.95



PRODUCT CERTIFIED FOR LOW CHEMICAL EMISSIONS: UL.COM/IGG UL 2818

**MooreCo® Presentation Cart**

This presentation cart has an 18 gauge frame and shelf surfaces that have a MDF core covered in gray melamine. Keep your laptop, LCD projector, or other equipment at just the right height. Laptop shelf adjusts from 19" to 39-1/2" high in 1-1/4" increments. Handy unit rolls on heavy-duty 3" casters (2 locking) for easy maneuverability. Grommets keep cords managed between shelves. Top shelf measures 18" W x 14" D. Middle shelf measures 16" W x 9-1/2" D. Bottom shelf measures 18" W x 18" D. Optional electrical assembly has 4 UL/CSA approved outlets, 25' cord and cord winder. Black powder-coated steel frame and a gray top. TAA compliant.

Item #	Description	Product Dimensions	Color	List Price
6-677897-670	Presentation Cart	40-1/4 W x 18 D x 30 H in	Gray	\$565.95
6-677900-670	Electrical Assembly (w/winder)	25 H in	Black/Gray	\$155.95



**LUXOR**

**Luxor Presentation Cart**

This versatile cart caters to multiple users in a variety of environments. The convenient pneumatic foot pedal swiftly and quietly adjusts the height between 28"-42.5", allowing users to comfortably sit or stand. The tabletop easily tilts and transforms into a presenter's shelf, or the tabletop can also remain flat. Paper-stopping lip keeps materials and equipment in place. Two casters allow easy transportation.

Item #	Description	Product Dimensions	List Price
6-1581424-670	Presentation Cart	25-1/2 W x 28 to 42-1/2 H in	\$534.95



PRC200



PRC250



PRC400



PRC450

**Oklahoma Sound®  
PRC200 & PRC250 Premium Presentation Carts**

The PRC200 and PRC250s are multi-faceted carts that are the perfect presentation and storage solution for all your AV equipment. This product includes an adjustable projector and laptop shelf which ranges in height from 19" to 39-1/2". Its many compartments make storing and moving your accessories easy! All three shelves are adjustable and removable. Includes a locking cabinet and four easy-roll 3" heavy duty casters, two of which are locking. PRC250 includes a six-outlet power strip with a 25-foot cord winder.

Item #	Description	Product Dimensions	Color	List Price
6-1280778-670	PRC 200 Cart	30 W x 18 D x 40-1/2 H in	Black/Ivory	\$317.95
6-1442286-670	PRC 250 Cart	30 W x 18 D x 40 1/2 H in	Black/Ivory	\$863.95

**Oklahoma Sound®  
PRC400 & PRC450 Premium Presentation Carts**

The PRC400 and PRC450s are multi-functional, wide presentation cart with ample storage and display space for equipment like laptops or projectors. Safely protect all valuable devices in the spacious locking cabinet with an adjustable or removable middle shelf. Adjust the laptop shelf for presenting while either sitting or standing. Easily move this steel cart from room to room on four 4" casters, two of which lock. PRC450 includes a six-outlet power strip with a 20-foot cord and a CPU holder.

Item #	Description	Product Dimensions	Color	List Price
6-1442287-670	PRC 400 Cart	21 W x 33 D x 40 H in	Black/Ivory	\$926.95
6-1442288-670	PRC 450 Cart	21 W x 33 D x 40 H in	Black/Ivory	\$1,047.95



**Oklahoma Sound®  
Multi Media Presentation Cart**

The multimedia cart from Oklahoma Sound® features a slide-out laptop shelf and dual flip-up shelves that offer plenty of space for a laptop, projector, and document camera all at once. A locking drawer and cabinet let you conveniently store your presentation equipment inside the cart. The durable particleboard core has an attractive high-pressure laminate covering that resists dents, scratches, and peeling. Four swivel casters, two of which are locking, allow for smooth movement around your classroom.

Item #	Description	Product Dimensions	Color	List Price
6-1442289-670	Multi Media A/V Cart	25 W x 19 D x 38 H in	Cherry	\$700.95



**Oklahoma Sound®  
The Wizard Presentation Center**

Constructed of 18-gauge steel with square tube corner supports and accented with a cherry wood surface. The lockable storage cabinet and sliding shelf are designed to support all leading brand document cameras and LCD projectors. A flip-up side shelf measuring 16"L X 14"W provides the option of having your laptop and document camera available to use simultaneously. Unit easily rolls on 4" casters. A 20-foot power cord with a 6-outlet power strip is mounted in the inside of the unit for easy wire management. Shipped pre-assembled.

Item #	Description	Product Dimensions	Color	List Price
6-1365285-670	Wizard Presentation Center	21 W x 18 D x 40 H in	Cherry/Black	\$1,740.95



**Oklahoma Sound®  
Greystone Series Lecterns with or without Sound**

This elegantly designed unit offers an all-in-one presentation experience.

- Large reading surface (22.75" W x 18.25" D)
- Two side pull-out shelves (14.25" W x 12" D)
- Sliding keyboard tray (17.5" W x 9.25" D)
- The cabinet includes three large shelves plus an oversized front drawer for ample storage
- 2.5" hooded twin wheel matching casters

Choose either a no sound or a sound option.

Item #	Description	Product Dimensions	Color	List Price
<b>No Sound</b>				
9-2021566-670	Lectern	23-1/2 W x 45-1/2 H in	Charcoal Black	\$1,128.95
<b>With Sound</b>				
9-2028616-670	Lectern-Sound-Wired Mic	23-1/2 W x 45-1/2 H in	Charcoal Black	\$2,026.95
9-2028744-670	Lectern-Sound-Lapel Mic	23-1/2 W x 45-1/2 H in	Charcoal Black	\$2,317.95
9-2028747-670	Lectern-Sound-Headset Mic	23-1/2 W x 45-1/2 H in	Charcoal Black	\$2,377.95
9-2028745-670	Lectern-Sound-Wireless Mic	23-1/2 W x 45-1/2 H in	Charcoal Black	\$2,417.95
<b>With Sound and Battery</b>				
9-2028749-670	Lectern-Sound-Battery-Wired	23-1/2 W x 45-1/2 H in	Charcoal Black	\$2,267.95
9-2028746-670	Lectern-Sound-Battery-Lapel	23-1/2 W x 45-1/2 H in	Charcoal Black	\$2,558.95
9-2028748-670	Lectern-Sound-Battery-Headset	23-1/2 W x 45-1/2 H in	Charcoal Black	\$2,558.95
9-2028743-670	Lectern-Sound-Battery-Wireless	23-1/2 W x 45-1/2 H in	Charcoal Black	\$2,658.95



Medium Oak

**Oklahoma Sound®  
#222 Full Floor Lectern**

Attractive and durable; this is a 3/4" stain and scratch resistant, thermo-fused melamine laminate on MDF on a full floor lectern.

- Full size reading surface, shelf and paper/book stop built-in
- Comes with floor glides
- Convert to a mobile unit with optional caster kit
- Easy to assemble
- Available in Medium Oak and Mahogany

Item #	Description	Product Dimensions	Color	List Price
6-1363823-670	Lectern	23 W x 46-1/2 H in	Specify	\$352.95
9-677708-670	Caster Kit (Set of 4)	1/2 W x 2 H in		\$42.95

**Oklahoma Sound®  
#600 Aristocrat Lectern  
Includes Keyboard Tray**

An up-scale contoured design for professional, attractive look. Spacious reading surface with generous book stop.

- Ingenious slide-out shelf for integrating multimedia presentations
- Slides out to the right or left up to 16", 30 lbs. maximum capacity
- Two built in shelves
- Concealed casters, two locking
- Assembly required
- Available in Cherry, Medium Oak, and Mahogany



Mahogany

Item #	Description	Product Dimensions	Color	List Price
6-1364295-670	Lectern w/Pull-out Side Shelf	25 W x 46 H in	Specify	\$690.95



Ribbonwood

**Oklahoma Sound®  
#800X Lectern**

Suitable for medium-sized venues like meeting halls, auditoriums, and cafeterias. It offers a spacious reading surface illuminated by a brass lamp. Shelf space provides convenient storage. Includes a handheld mic with 9' cable and a gooseneck mic holder, and your choice of a wireless microphone option. Available in Mahogany and Ribbonwood.

Item #	Description	Product Dimensions	Color	List Price
6-1363829-670	Sound Lectern-Mic options	22 W x 46 H in	Specify	\$2,061.95
6-5000335-670	Sound Lectern w/Mic & Battery	22 W x 46 H in	Specify	\$2,280.95
9-672601-670	Optional Rechargeable Battery	2-3/4 W x 3-1/2 H in		\$218.95

**Oklahoma Sound Lectern Finish**



PLEASE SPECIFY COLOR CHOICE



**Oklahoma Sound®  
ZED Lectern with Speaker**

The ZED lectern is a versatile, 40-watt sound lectern, suitable for medium sized venues like conference rooms, meeting halls, auditoriums, and cafeterias. Equipped with halogen lamp, four concealed casters and a digital timepiece.

Item #	Description	Product Dimensions	Color	List Price
6-2103564-670	Black	19-3/4 W x 49 H in	Black	\$1,561.95



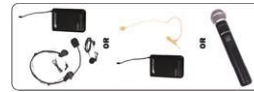

Wireless models include choice of mic

**AmplivoX® Multimedia Computer Lectern with Sound**

The Multimedia Computer Lectern has incredible features that offer a unique presentation experience.

- 4" locking drawer for a laptop and drop-leaf shelf for projector
- Lectern features 2 built-in speakers and 21" electret condenser gooseneck mic.
- Includes 10' Power Cord
- One locking door provides secure storage for extra equipment
- Includes 1 adjustable inner shelf and wire management grommets
- Available in Mahogany, Cherry, Maple, Walnut and Oak

Batteries not included. Please contact your local sales rep for customized logo solutions.



Mahogany

Item #	Description	Product Dimensions	Color	List Price
6-1541470-670	Lectern w/Wireless Sound	26 W x 20 D x 44 H in	Specify	\$3,425.95

**AmplivoX® Presidential Plus Lectern**

Non-sound Presidential Plus Lectern constructed of 3/4" melamine laminate with protective T-molding. 4 hidden casters (2 locking). Features 2 storage shelves for storing books and other materials. Assembly Required. Available in Mahogany, Oak and Walnut. Please contact your local sales rep for customized logo solutions.



Item #	Description	Product Dimensions	Color	List Price
6-1541459-670	Presidential Plus Lectern	26 W x 21 D x 47 H in	Specify	\$1,358.95

**AmplivoX® Adjustable Executive Column Sound Lecterns**

This scratch resistant with melamine finish lectern with radiused corners for durability is perfect for any classroom or auditorium.

- Ideal for audiences up to 1,950 people and room size up to 19,450 sq. ft.
- Choice of wireless mic: lapel & headset, flesh tone over-ear, or handheld microphone
- Lectern height adjusts quickly with easy-adjust pneumatic dial
- Built in Bluetooth® Module allows you to wirelessly stream sound
- 4 casters (2 locking) for easy portability
- Includes 10' power cord
- Available in Mahogany, Oak, Maple, Walnut and Black

Batteries not included. Please contact your local sales rep for customized logo solutions.

Customize any Lectern with your School Logo



Item #	Description	Product Dimensions	Color	List Price
6-1541467-670	Lectern w/Wireless Sound	22 W x 17 D x 38 - 44 H in	Specify	\$4,920.95

**AmplivoX® Curved Hardrock Lectern**

A great looking addition to any conference room, lecture hall or meeting place, this stylish model sports a curved front panel and flat rear panel. The lectern provides a spacious reading table and sturdy base which are made from high quality MDF for great looks and long life. Batteries not included for sound models. Please contact your local sales rep for customized logo solutions.



Granite

Mahogany

Item #	Description	Product Dimensions	Color	List Price
6-2103785-670	No Sound-Maple	26-3/4W x 17-1/2D x 48-3/4H In	Maple	\$3,969.95
6-5009534-670	Sound-Maple	26-3/4W x 17-1/2D x 48-3/4H In	Maple	\$5,752.95
6-2104222-670	No Sound-Granite	26-3/4W x 17-1/2D x 48-3/4H In	Granite	\$3,969.95
6-5009537-670	Sound-Granite	26-3/4W x 17-1/2D x 48-3/4H In	Granite	\$5,752.95
6-2104221-670	No Sound-Mahogany	26-3/4W x 17-1/2D x 48-3/4H In	Mahogany	\$3,969.95
6-5009536-670	Sound-Mahogany	26-3/4W x 17-1/2D x 48-3/4H In	Mahogany	\$5,752.95
6-2104223-670	No Sound-Cherry	26-3/4W x 17-1/2D x 48-3/4H In	Cherry	\$3,969.95
6-5009535-670	Sound-Cherry	26-3/4W x 17-1/2D x 48-3/4H In	Cherry	\$5,752.95

Finishes are available for all lecterns, please refer to individual items for availability.

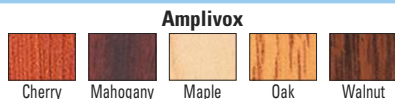

Walnut

**AmplivoX® Capri Lectern**

The Capri lectern is the perfect combination of style and practicality. Made of a scratch resistant melamine laminate finish with elegant, curved construction for durability that will stand the test of time. Use the slanted reading table with paper stop to easily present your materials, this lightweight lectern moves effortlessly on four plastic glides. No tools required for assembly. Available in Mahogany and Maple. Please contact your local sales rep for customized logo solutions.

Item #	Description	Product Dimensions	Color	List Price
6-5009622-670	Capri Lectern-No Sound	24 W x 18 D x 44 H in	Specify	\$1,152.95



# presentation



### MooreCo® Visionary Glass Board

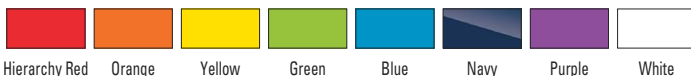

Also available in White Glass

### MooreCo® Visionary™ Magnetic Glass Board

The magnetic glass dry erase board provides the best of a quality markerboard with smart style. Surface and coloration are engineered for ideal optical qualities. The glass exhibits good depth of field, good contrast, and ambient light toleration. Compatible with any dry/wet-erase marker or grease pen, and easily cleans without ghosting or staining. Includes simple and sturdy mounting devices that are padded to protect the surface. Aluminum accessory tray included. Only accepts rare earth magnets, four are included.

Item #	Description	Product Dimensions	Color	List Price
9-1433974-670	Visionary Glass Board	35-7/16 W x 23-1/2 H in	White	\$268.95
6-1433975-670	Visionary Glass Board	47-1/4 W x 35-7/16 H in	White	\$489.95
9-1595170-670	Visionary Glass Board	47-1/4 W x 35-7/16 H in	Specify	\$526.95
6-1425765-670	Visionary Glass Board	70-7/8 W x 47-1/4 H in	White	\$947.95
6-1595171-670	Visionary Glass Board	70-7/8 W x 47-1/4 H in	Specify	\$1,023.95
6-1433976-670	Visionary Glass Board	94-1/2 W x 47-1/4 H in	White	\$1,155.95
6-1595172-670	Visionary Glass Board	94-1/2 W x 47-1/4 H in	Specify	\$1,256.95



Items ship within 24 hrs, 48 hrs, 1 or 2 weeks as indicated when the factory distribution center receives the order.



See Shipping & Handling terms for details.



PRODUCT CERTIFIED FOR LOW CHEMICAL EMISSIONS: UL.COM/CGG UL 2818

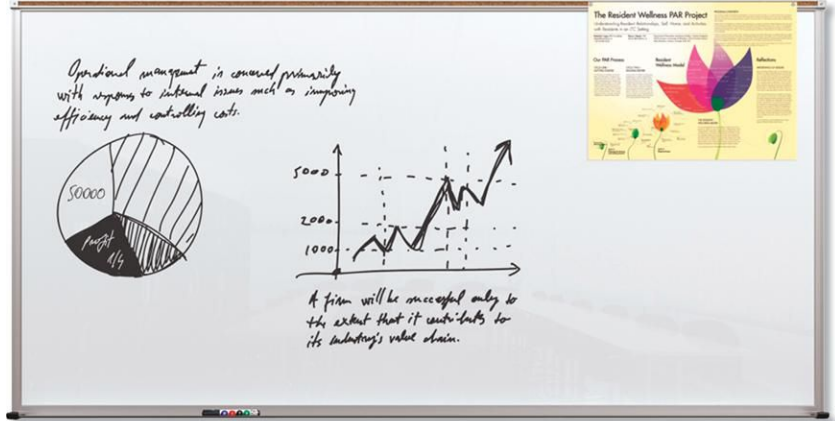

**MooreCo® Framed Magnetic Glass Dry Erase Markerboard**

Framed magnetic glass boards provide the best of a quality markerboard with smart style. Compatible with any dry/wet-erase marker, grease pen, etc. Easily cleans without ghosting or staining. Includes a full-length tackable map rail with a colored cork insert, and a full-length accessory tray with rubber Dura-Safe end caps to eliminate sharp edges. Special trim is designed with vinyl glazing so that the aluminum does not contact the glass at all. The trim corners are mitered and attached with friction locks. Only accepts rare earth magnets, four are included.

Item #	Description	Product Dimensions	Color	Frame Color	List Price
6-1577126-670	Magnetic Glass Markerboard	4 W x 3 H ft	White	Aluminum	\$1,374.95
6-1577127-670	Magnetic Glass Markerboard	6 W x 4 H ft	White	Aluminum	\$1,960.95
6-1577128-670	Magnetic Glass Markerboard	8 W x 4 H ft	White	Aluminum	\$2,377.95

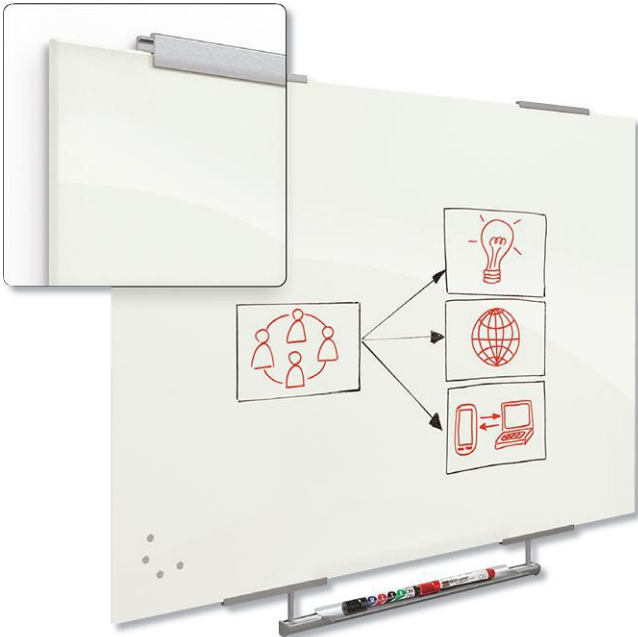

**MooreCo® Visionary™ Magnetic Glass Dry Erase with Exo Tray System**

Visionary™ magnetic glass boards provide the best of a quality whiteboard with smart style. Tempered safety glass ideal for use in any environment. Compatible with any dry/wet-erase marker, grease pen, etc. Easily cleans without ghosting or staining. Includes set of magnets, markers, and eraser.

Item #	Description	Product Dimensions	Color	Frame Color	List Price
9-1577132-670	Gloss White Board	3 W x 2 H ft	White	Aluminum	\$521.95
9-1577133-670	Gloss White Board	4 W x 3 H ft	White	Aluminum	\$851.95
6-1577134-670	Gloss White Board	6 W x 4 H ft	White	Aluminum	\$1,647.95
6-1577135-670	Gloss White Board	8 W x 4 H ft	White	Aluminum	\$1,971.95





PRODUCT CERTIFIED FOR LOW CHEMICAL EMISSIONS: UL.COM/IGG UL-2818



### MooreCo® Interactive Projector Board with Brio Trim

For the best projection surface and most durable whiteboard, choose the Interactive Projector Board as your ultimate multifunction board. The available surfaces can be cleaned of even stubborn permanent markers, and at the same time, engineered to minimize visual strain from anywhere in the room, making it ideal for spaces that are exposed to ambient light. Projector not included.

Item #	Product Dimensions	Color	List Price
6-1595406-670	6 W x 4 H ft	Standard Gloss White	\$1,081.95
6-1595413-670	6 W x 4 H ft	Low Gloss White	\$1,118.95
6-1595407-670	8 W x 4 H ft	Standard Gloss White	\$1,335.95
6-1587458-670	8 W x 4 H ft	Low Gloss White	\$1,373.95
6-1595408-670	8 W x 5 H ft	Standard Gloss White	\$1,799.95
6-1595414-670	8 W x 5 H ft	Low Gloss White	\$1,801.95

### MooreCo® Whiteboard with Ultra Trim

Magnetic porcelain steel whiteboards are engineered for superior color contrast. Standard gloss dry erase surface provides superior writability and erasability with no ghosting. Reduced surface light distortion enhances visibility to provide optimum eye comfort. Steel is permanently laminated to a lightweight substrate for stability and durability. Featured with Ultra Trim for a modern, clean lined board. Includes matching storage tray.

Item #	Description	Product Dimensions	Frame Color	List Price
6-1289863-670	Ultra Trim Whiteboard	4 W x 3 H in	Silver	\$589.95
6-1335435-670	Ultra Trim Whiteboard	6 W x 4 H ft	Silver	\$1,018.95
6-1406324-670	Ultra Trim Whiteboard	8 W x 4 H ft	Silver	\$1,208.95

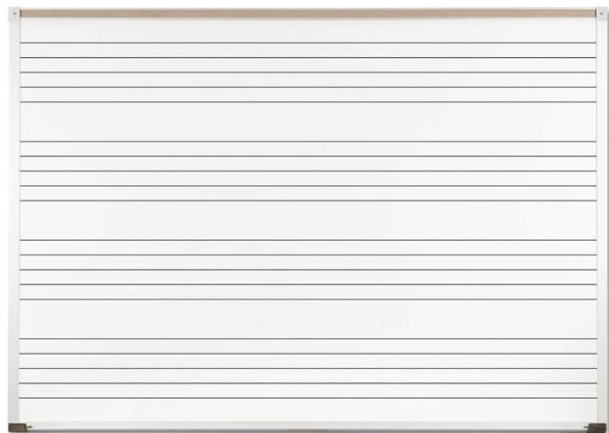
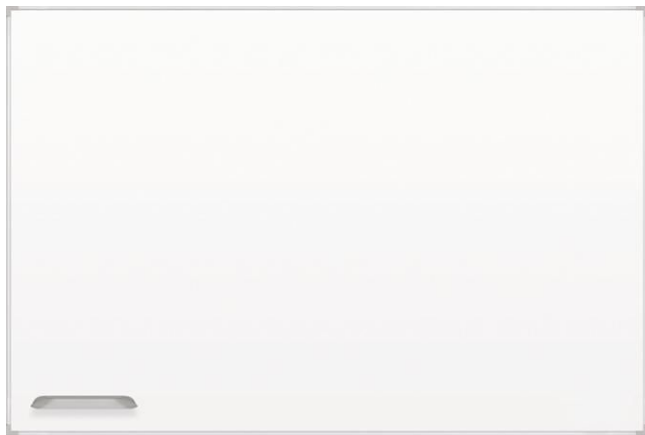

### MooreCo® Music Line Boards

Porcelain steel surface markerboards with permanently embedded graphics are as indestructible as they are functional. Factory framed with map rail and marker tray.

Item #	Description	Product Dimensions	Frame Color	List Price
6-661949-670	Music Lines	4 W x 6 H ft	Aluminum	\$1,299.95
6-661950-670	Music Lines	4 W x 8 H ft	Aluminum	\$1,715.95



QUICKSHIP Items ship within 24 hrs, 48 hrs, 1 or 2 weeks as indicated when the factory distribution center receives the order.



See Shipping & Handling terms for details.



PRODUCT CERTIFIED FOR LOW CHEMICAL EMISSIONS: UL COM1GG UL 2815

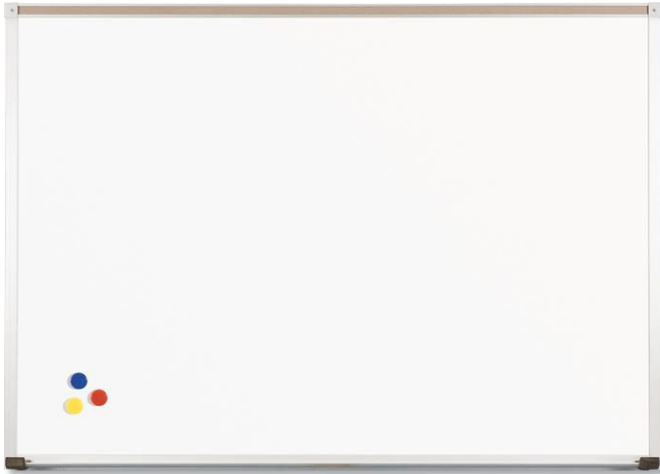

### MooreCo® Porcelain Steel Deluxe Markerboards

- The porcelain steel markerboard surface consists of a low-gloss magnetic steel surface laminated to a 7/16" thick MDF substrate for extra strength and moisture resistance
- The surface is engineered to create greater color contrast with dry erase markers. Marker ghosting is not a problem with the porcelain steel surface, which offers superior erasability
- The reduced surface light distortion enhances visibility to provide optimum eye comfort
- Aluminum frame includes full-length map rail with cork insert and full-length accessory tray with Dura-Safe® rubber end caps
- Doubles as magnetic bulletin board
- Boards include L-clips, rawl plugs, and screws for installation
- Magnets are not included

Item #	Description	Product Dimensions	Frame Color	List Price
9-658062-670	Porcelain Steel Deluxe Board	3 W x 2 H ft	Aluminum	\$294.95
5-608476-670	Porcelain Steel Deluxe Board	4 W x 3 H ft	Aluminum	\$394.95
6-608475-670	Porcelain Steel Deluxe Board	4 W x 4 H ft	Aluminum	\$640.95
6-716839-670	Porcelain Steel Deluxe Board	4 W x 5 H ft	Aluminum	\$688.95
6-608491-670	Porcelain Steel Deluxe Board	6 W x 4 H ft	Aluminum	\$713.95
6-608513-670	Porcelain Steel Deluxe Board	8 W x 4 H ft	Aluminum	\$834.95
6-608521-670	Porcelain Steel Deluxe Board	10 W x 4 H ft	Aluminum	\$1,082.95
6-608548-670	Porcelain Steel Deluxe Board	12 W x 4 H ft	Aluminum	\$1,150.95
6-608556-670	Porcelain Steel Deluxe Board	16 W x 4 H ft	Aluminum	\$1,534.95

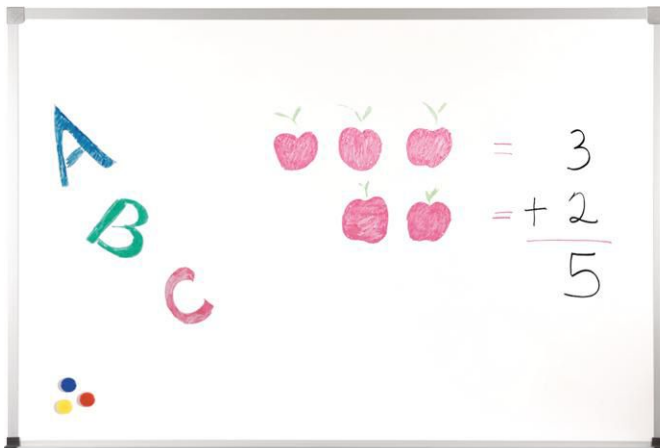

### Essentials™ by MooreCo® ABC™ Board Series

- Magnetic porcelain steel markerboards are engineered for superior color contrast with dry erase markers
- Low gloss porcelain dry erase surface provides superior writability and erasability with no ghosting
- Reduced surface light distortion enhances visibility to provide optimum eye comfort
- Steel surface is permanently laminated to a particle board substrate for stability and durability
- Anodized aluminum ABC Trim has a 7/8" profile with hairline mitered corners
- Full-length accessory tray includes plastic end caps to eliminate sharp corners
- Magnets are not included

Item #	Description	Product Dimensions	List Price
5-677049-670	Porcelain Steel Markerboard	4 W x 3 H ft	\$505.95
6-677050-670	Porcelain Steel Markerboard	4 W x 4 H ft	\$653.95
6-677051-670	Porcelain Steel Markerboard	6 W x 4 H ft	\$798.95
6-677052-670	Porcelain Steel Markerboard	8 W x 4 H ft	\$866.95



ESSENTIALS BY MOORECO



PRODUCT CERTIFIED FOR LOW CHEMICAL EMISSIONS  
UL COMFG  
UL 2818



TYPE C



TYPE E

Tackboard Colors



Sterling



Champagne



Cotton



Gray



Pacific Blue



Platinum

PLEASE SPECIFY COLOR CHOICE

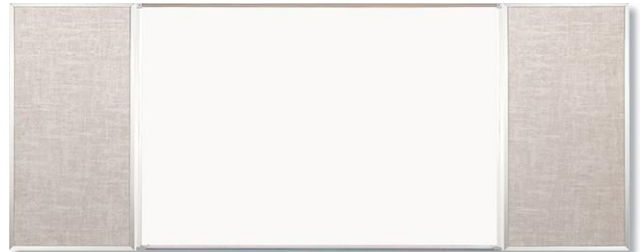

TYPE F

MooreCo® Combo-Rite Modular Boards

Why replace a whole combination board when you have a modular system? Combo-Rite boards feature Porcelain Steel markerboards complete with tackboard panels that can be replaced as needed. The durable porcelain steel writing surface is laminated to 1/2" thick MDF. Tackboard panels are available in vinyl over insulation board.

Item #	Description	Product Dimensions	Frame Color	Tackboard Color	List Price
<b>Type C</b>					
6-1371625-670	Writing Surface -4 H x 8 W ft	5 H x 6 W ft	Aluminum	Specify	\$1,321.95
6-1371626-670	Writing Surface -4 H x 8 W ft	5 H x 8 W ft	Aluminum	Specify	\$2,033.95
6-1371627-670	Writing Surface -4 H x 10 W ft	5 H x 10 W ft	Aluminum	Specify	\$2,693.95
6-1371628-670	Writing Surface -4 H x 12 W ft	5 H x 12 W ft	Aluminum	Specify	\$2,983.95
6-1371629-670	Writing Surface -4 H x 16 W ft	5 H x 16 W ft	Aluminum	Specify	\$3,867.95
<b>Type E</b>					
6-1371616-670	Writing Surface -4 H x 4 W ft	4 H x 6 W ft	Aluminum	Specify	\$1,493.95
6-1371617-670	Writing Surface -4 H x 6 W ft	4 H x 8 W ft	Aluminum	Specify	\$1,646.95
6-1371619-670	Writing Surface -4 H x 6 W ft	4 H x 10 W ft	Aluminum	Specify	\$1,792.95
6-1371621-670	Writing Surface -4 H x 8 W ft	4 H x 12 W ft	Aluminum	Specify	\$1,899.95
6-1371623-670	Writing Surface -4 H x 12 W ft	4 H x 16 W ft	Aluminum	Specify	\$2,548.95
<b>Type F</b>					
6-1371618-670	Writing Surface -4 H x 4 W ft	4 H x 8 W ft	Aluminum	Specify	\$1,730.95
6-1371620-670	Writing Surface -4 H x 6 W ft	4 H x 10 W ft	Aluminum	Specify	\$1,868.95
6-1371622-670	Writing Surface -4 H x 8 W ft	4 H x 12 W ft	Aluminum	Specify	\$2,120.95
6-1371624-670	Writing Surface -4 H x 8 W ft	4 H x 16 W ft	Aluminum	Specify	\$3,174.95

Ghent® Magnetic Porcelain Whiteboards

- Porcelain-on-steel surface; the hardest marker surface available
- Scratch resistant surface backed by a 50 yr. guarantee
- Available in satin anodized aluminum or hard wood oak framing

⚠ WARNING: This product can expose you to chemicals including Wood Dust, which is known to the State of California to cause cancer. For more information go to [www.P65Warnings.ca.gov](http://www.P65Warnings.ca.gov).



Item #	Description	Product Dimensions	Frame Color	List Price
<b>Aluminum Frame Porcelain Markerboard</b>				
5-653989-670	Porcelain Steel Markerboard	2 W x 3 H ft	Satin	\$279.95
5-653992-670	Porcelain Steel Markerboard	3 W x 4 H ft	Satin	\$501.95
6-653995-670	Porcelain Steel Markerboard	4 W x 5 H ft	Satin	\$649.95
6-653998-670	Porcelain Steel Markerboard	4 W x 6 H ft	Satin	\$764.95
6-654001-670	Porcelain Steel Markerboard	4 W x 8 H ft	Satin	\$902.95
6-675078-670	Porcelain Steel Markerboard	4 W x 10 H ft	Satin	\$1,255.95
6-674849-670	Porcelain Steel Markerboard	4 W x 12 H ft	Satin	\$1,510.95
<b>Wood Frame Porcelain Markerboard</b>				
5-662559-670	Porcelain Steel Markerboard	2 W x 3 H ft	Oak	\$346.95
5-662560-670	Porcelain Steel Markerboard	3 W x 4 H ft	Oak	\$521.95
6-662561-670	Porcelain Steel Markerboard	4 W x 5 H ft	Oak	\$756.95
6-662562-670	Porcelain Steel Markerboard	4 W x 6 H ft	Oak	\$892.95
6-662563-670	Porcelain Steel Markerboard	4 W x 8 H ft	Oak	\$1,114.95
6-674856-670	Porcelain Steel Markerboard	4 W x 10 H ft	Oak	\$1,417.95
6-675083-670	Porcelain Steel Markerboard	4 W x 12 H ft	Oak	\$1,625.95

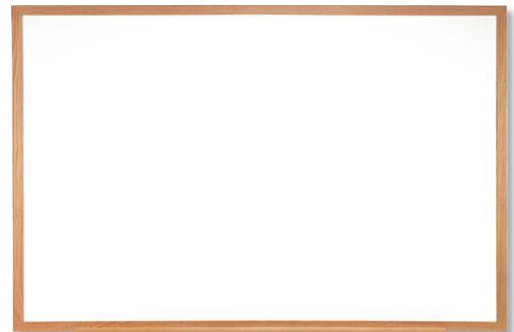



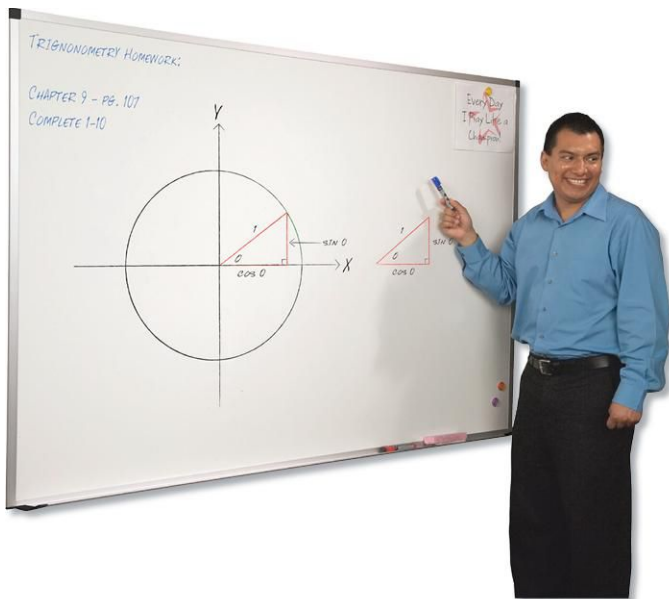

### MooreCo® Magne-Rite™ Deluxe Markerboards

- An exceptional dry erase surface at an exceptional value
- Features a surface made of steel with a special PVC coating
- The magnetic steel surface is laminated to 1/4" thick MDF
- The board includes a tackable map rail and a full-length accessory tray with silicone rubber Dura-Safe® end caps
- Boards come with a free set of Rite-On™ markers and cleaning cloth

Item #	Description	Product Dimensions	Frame Color	List Price
9-678658-670	Magne-Rite Deluxe Board	3 W x 2 H ft	Aluminum	\$319.95
5-678659-670	Magne-Rite Deluxe Board	4 W x 3 H ft	Aluminum	\$390.95
6-678660-670	Magne-Rite Deluxe Board	4 W x 4 H ft	Aluminum	\$542.95
6-678661-670	Magne-Rite Deluxe Board	6 W x 4 H ft	Aluminum	\$582.95
6-678662-670	Magne-Rite Deluxe Board	8 W x 4 H ft	Aluminum	\$692.95

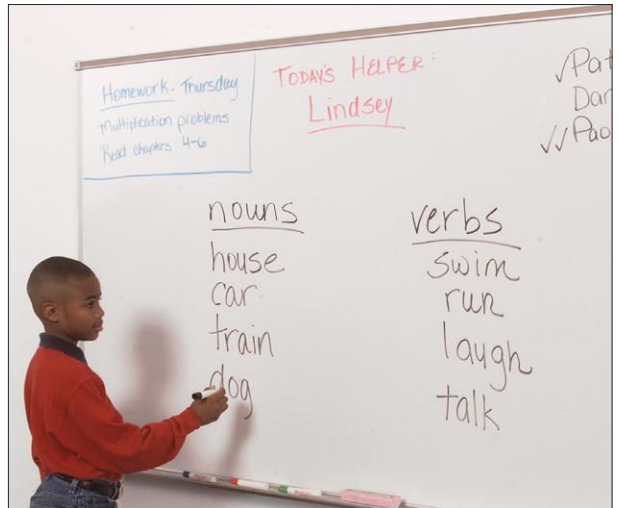

### MooreCo® Dura-Rite® Markerboards

- The Dura-Rite® Board surface is an exceptionally wear-resistant high-pressure laminate
- The laminate stands up to years of heavy use yet is budget conscious
- Dust-free surface ensures smooth writability and easy erasability
- Aluminum frame includes full-length map rail with cork insert and full-length accessory tray with Dura-Safe® rubber end caps
- Boards include L-clips, rawl plugs, and screws for installation



Item #	Description	Product Dimensions	Frame Color	List Price
5-674526-670	Dura-Rite Markerboard	4 W x 3 H ft	Aluminum	\$450.95
6-674527-670	Dura-Rite Markerboard	4 W x 4 H ft	Aluminum	\$507.95
6-674528-670	Dura-Rite Markerboard	5 W x 4 H ft	Aluminum	\$653.95
6-674529-670	Dura-Rite Markerboard	6 W x 4 H ft	Aluminum	\$654.95
6-674530-670	Dura-Rite Markerboard	8 W x 4 H ft	Aluminum	\$663.95



PRODUCT CERTIFIED FOR LOW CHEMICAL EMISSIONS: UL COMING UL 2818

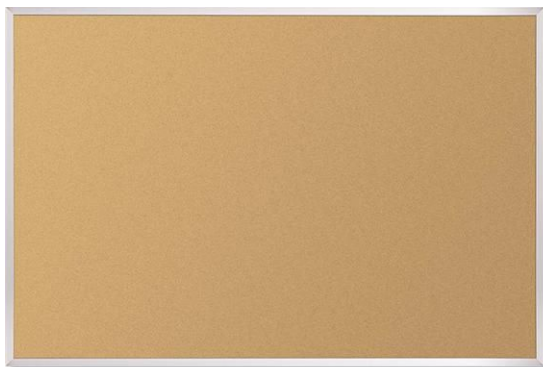

### MooreCo® Valu-Tak Tackboards

Resilient surface recovers from tack holes. Features 1/16" thick cork layer bonded to 7/16" lightweight and tackable substrate material.

- Natural cork surface
- Aluminum frame
- Loop mounting hangers for 3 H ft and smaller
- L-Clips for boards 4 H ft and larger

Item #	Description	Product Dimensions	Frame Color	List Price
5-1454594-670	Valu-Tak Tackboard	4 W x 3 H ft	Aluminum	\$282.95
6-608882-670	Valu-Tak Tackboard	4 W x 4 H ft	Aluminum	\$358.95
6-658020-670	Valu-Tak Tackboard	5 W x 3 H ft	Aluminum	\$368.95
6-608890-670	Valu-Tak Tackboard	5 W x 4 H ft	Aluminum	\$386.95
6-608904-670	Valu-Tak Tackboard	6 W x 4 H ft	Aluminum	\$394.95
6-608912-670	Valu-Tak Tackboard	8 W x 4 H ft	Aluminum	\$440.95
6-608920-670	Valu-Tak Tackboard	10 W x 4 H ft	Aluminum	\$618.95
6-608939-670	Valu-Tak Tackboard	12 W x 4 H ft	Aluminum	\$639.95

### MooreCo® Natural Add-Cork

Self-healing cork withstands heavy use. 1/8" thick cork layer bonded to 3/8" thick durable substrate material.

- Natural cork surface
- Aluminum frame
- Mounting brackets included

Item #	Description	Product Dimensions	Tackboard Color	List Price
5-661896-670	Natural Cork Tackboard	4 W x 3 H ft	Natural Cork	\$405.95
6-661897-670	Natural Cork Tackboard	4 W x 4 H ft	Natural Cork	\$530.95
6-661898-670	Natural Cork Tackboard	5 W x 4 H ft	Natural Cork	\$580.95
6-661899-670	Natural Cork Tackboard	6 W x 4 H ft	Natural Cork	\$591.95
6-661900-670	Natural Cork Tackboard	8 W x 4 H ft	Natural Cork	\$677.95
6-661901-670	Natural Cork Tackboard	10 W x 4 H ft	Natural Cork	\$962.95
6-661902-670	Natural Cork Tackboard	12 W x 4 H ft	Natural Cork	\$990.95



### MooreCo® Vin-Tak Tackboards

Attractive, colorful surface over 1/2" insulation board.

- Easily cleaned and washable
- Class A flame resistant vinyl
- Mounting hardware included
- Heavy gauge aluminum frame
- Non-fading

Item #	Description	Product Dimensions	Tackboard Color	Frame Color	List Price
9-1362427-670	Vin-Tak Tackboard	3 W x 2 H ft	Specify	Aluminum	\$244.95
5-1362428-670	Vin-Tak Tackboard	4 W x 3 H ft	Specify	Aluminum	\$316.95
6-1362429-670	Vin-Tak Tackboard	4 W x 4 H ft	Specify	Aluminum	\$413.95
6-1362430-670	Vin-Tak Tackboard	5 W x 4 H ft	Specify	Aluminum	\$433.95
6-1362431-670	Vin-Tak Tackboard	6 W x 4 H ft	Specify	Aluminum	\$442.95
6-1362432-670	Vin-Tak Tackboard	8 W x 4 H ft	Specify	Aluminum	\$495.95
6-1362433-670	Vin-Tak Tackboard	10 W x 4 H ft	Specify	Aluminum	\$692.95
6-1362434-670	Vin-Tak Tackboard	12 W x 4 H ft	Specify	Aluminum	\$717.95



Sterling



Pacific Blue



Cotton



Champagne



Gray



Platinum

#### Vin-Tak Colors



**QUICKSHIP**  
Items ship within 24 hrs, 48 hrs, 1 or 2 weeks as indicated when the factory distribution center receives the order.

Items ship **Freight** or **Parcel**

See Shipping & Handling terms for details.

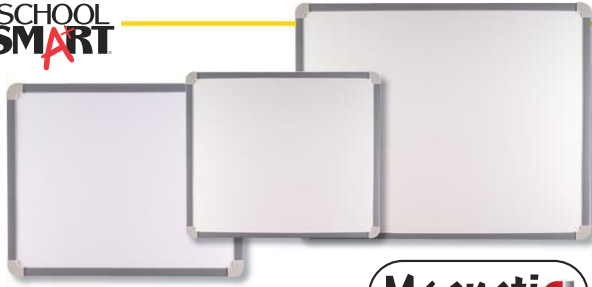

**Magnetic Dry Erase Boards**

These dual purpose coated plain metal boards with aluminum frames are perfect for use with magnetic letters, numbers, shapes and wipe off markers. Measures 17.45 mm thick.

Item #	Description	Product Dimensions	Quantity	List Price
9-086538-670	Student Board	8 x 12 in	Each	\$15.99
9-070626-670	Small Board	14 1/2 in x 17 1/4 in	Each	\$26.69
9-070627-670	Medium Board	17 1/2 in x 22 in	Each	\$33.29
9-070628-670	Large Board	23 in x 30 in	Each	\$53.29

**Dry Erase Student Boards**

High quality white dry erase boards, plain. Safety rounded corners. Writes and wipes off easily. Single-sided whiteboards measure 2.9 mm thick.



Item #	Description	Product Dimensions	Quantity	List Price
<b>9 in x 12 in Boards</b>				
9-1528372-670	Plain Student Board	9 x 12 in	Each	\$5.29
9-1325120-670	Plain Student Board	9 x 12 in	Pack of 10	\$33.29
9-081895-670	Ruled Student Board	9 x 12 in	Pack of 10	\$42.69
9-1500335-670	Plain Student Board	9 x 12 in	Pack of 30	\$106.69
9-1500336-670	Ruled Student Board	9 x 12 in	Pack of 30	\$109.29
<b>12 in x 18 in Boards</b>				
9-1325094-670	Plain Student Board	12 x 18 in	Pack of 10	\$66.69
9-357197-670	Ruled Student Board	12 x 18 in	Pack of 10	\$69.29
9-1500337-670	Plain Student Board	12 x 18 in	Pack of 30	\$199.99
9-1500338-670	Ruled Student Board	12 x 18 in	Pack of 30	\$202.69

**Dry Erase Boards**

These economical dry erase boards are constructed of a unique material that makes them lightweight yet rigid and sturdy. These 11.3 mm boards have a superior writing surface - inks wipe off cleanly and easily. All boards can be hung vertically or horizontally and include one black dry erase marker. Available with a white or black frame.



Item #	Description	Product Dimensions	Quantity	List Price
9-633747-670	White Frame Board	11 x 17 in	Each	\$15.99
9-633749-670	White Frame Board	16 x 22 in	Each	\$21.29
9-633746-670	Black Frame Board	11 x 17 in	Each	\$15.99
9-633748-670	Black Frame Board	16 x 22 in	Each	\$21.29



Expanded Offering

**KleenSlate® Dry Erase Markers with Eraser Caps**

KleenSlate® medium point dry erase markers with washable felt eraser cap. Durable round tip writes easily and won't push in. Ink is low odor and conforms to CPSIA and ASTM D-4326 standards. Please see website for colors included in assortment sets.

Item #	NIB Type	Color	Quantity	List Price
9-2093988-670	Bullet	Black	Pack of 12	\$30.69
9-1281861-670	Bullet	Black	Pack of 24	\$61.29
9-1482508-670	Bullet	Black	Pack of 36	\$78.69
9-2103567-670	Bullet - Tank Size	Red, Blue, Black, Green	Set of 4	\$9.29
9-1438929-670	Bullet	Assorted	Set of 10	\$26.69
9-2020727-670	Bullet	Assorted	Set of 30	\$73.29



**Flipside® Two-Sided Dry Erase Boards with Pen & Clip**

Two-sided Dry Erase White Boards are great for teaching and practicing fundamentals at the early learner stage. Bright white boards have one surface that has a plain white dry erase surface. The other side contains 5 sets of blue headline and broken mid-line plus red baseline format. Each line set measures 1-1/8 inches with 3/8 inch of blank descender space between sets. Boards measure 9 x 12 inches. Includes dry erase pen and pen clip.

Item #	Description	Product Dimensions	Quantity	List Price
9-2010561-670	Two-Sided with Pen	9 x 12 in	Each	\$5.99
9-2010560-670	Two-Sided with Pen	9 x 12 in	Pack of 12	\$70.69
9-2010559-670	Two-Sided with Pen	9 x 12 in	Pack of 24	\$138.69



**Best-Rite® Economy Lapboards**

Encourage student interaction with the fun and functional lap board. Featuring a dry erase surface, the board is perfect for spelling, math, or other group activities.

Item #	Description	Product Dimensions	Color	Quantity	List Price
9-1434031-670	Lap Board	9 x 12 in	White	Set of 24	\$159.99



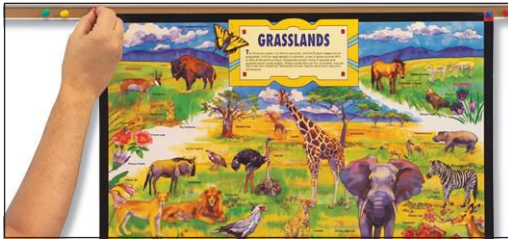

### MooreCo® Bulletin Bars

This small tackable surface makes a great note holder. Composed of long-lasting tan colored cork in a 1-inch-high aluminum frame. Each piece is furnished with double sided tape and magnetic strips for carefree mounting. 12 per case. Push pins included.

Item #	Description	Product Dimensions	Cork Color	Quantity	List Price
9-027034-670	Bulletin Bar	1 H in x 1 W ft	Natural	Case of 12	\$160.95
9-027037-670	Bulletin Bar	1 H in x 2 W ft	Natural	Case of 12	\$277.95
9-027040-670	Bulletin Bar	1 H in x 3 W ft	Natural	Case of 12	\$348.95



### Lorell Bulletin Bar Strips

Self-healing cork surface eliminates unsightly pinholes. Bulletin bar is framed with an anodized aluminum frame. It easily installs above whiteboards and chalkboards or secures directly to any wall. Easy to mount by adhesive foam tape or magnetic strip. Includes 3 pushpins.

Item #	Description	Product Dimensions	Cork Color	Quantity	List Price
9-1480484-670	Bulletin Bar	18 W in	Brown	Each	\$25.95
9-1480485-670	Bulletin Bar	24 W in	Brown	Each	\$30.95
9-1480486-670	Bulletin Bar	36 W in	Brown	Each	\$39.95
9-1480487-670	Bulletin Bar	48 W in	Brown	Each	\$45.95



### Quartet Bulletin Bar

Self-healing cork strips in a 1-inch-wide anodized aluminum frame. Includes double-sided tape and magnetic strips for mounting. Pushpins included.

Item #	Description	Product Dimensions	Cork Color	Quantity	List Price
9-1065953-670	Bulletin Bar	1 H x 18 W in	Brown	Each	\$35.95
9-1065954-670	Bulletin Bar	1 H x 24 W in	Brown	Each	\$45.95
9-1065955-670	Bulletin Bar	1 H x 36 W in	Brown	Each	\$50.95
9-1065956-670	Bulletin Bar	1 H x 48 W in	Brown	Each	\$58.95



### Advantus Map Rails

Low profile cork strip ideal for displaying posters, charts, or other items. It features an aluminum frame with satin finish and accepts flipchart hooks as well as thumbtacks. Mount rails end to end for longer lengths. Mounting hardware included.

Item #	Description	Product Dimensions	Cork Color	Quantity	List Price
9-1079106-670	Mounting Rail	1 H in x 8 W ft	Brown	Each	\$61.95
9-1078554-670	Mounting Rail	2 H in x 8 W ft	Brown	Each	\$94.95
9-1078555-670	Flip Chart Hook	2 W in		Each	\$5.25

### MooreCo® Tack-Bite Paper Holder

Tack-Bite paper holders are an innovative and safe way to display documents, posters or pictures. Features a unique roller system to provide a secure hold and quick release on papers without any damage, measures 2-1/2" high. Simply push in and lift out. Also includes a natural cork tackable insert for even more versatility. TAA compliant.



Item #	Description	Product Dimensions	Cork Color	Quantity	List Price
9-1467567-670	Display Rail	2-1/2 H in x 7 W in	Natural	Set of 6	\$137.95
9-1467568-670	Display Rail	2-1/2 H in x 1 W ft	Natural	Set of 6	\$188.95
9-1467569-670	Display Rail	2-1/2 H in x 2 W ft	Natural	Set of 6	\$344.95
9-1467570-670	Display Rail	2-1/2 H in x 3 W ft	Natural	Set of 6	\$437.95
9-1467571-670	Display Rail	2-1/2 H in x 4 W ft	Natural	Set of 6	\$575.95
9-1467572-670	Display Rail	2-1/2 H in x 6 W ft	Natural	Set of 6	\$790.95
9-1467573-670	Display Rail	2-1/2 H in x 8 W ft	Natural	Set of 4	\$811.95

### MooreCo® Map-Display Rail

Heavy gauge extruded aluminum. Cork insert is 1 inch high and 1/4" thick. Accessories slide on easily using strong spring clip hooks. Note: You may trim map rail to fit odd lengths. Roller brackets sold per pair. Map rails come in a six pack per size.

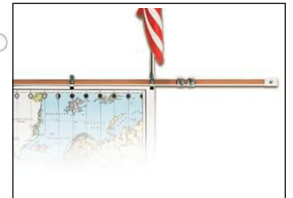

Item #	Description	Product Dimensions	Quantity	List Price
9-2028251-670	Display Rail	1 H in x 8 W ft	Set of 6	\$315.95
9-661710-670	Display Rail	1 H in x 10 W ft	Set of 6	\$357.95
9-661711-670	Display Rail	1 H in x 12 W ft	Set of 6	\$416.95
<b>Accessories</b>				
9-602886-670	Metal Map Hook	1 H in	Each	\$7.95
9-602889-670	End Stops	1 H in	Set of 2	\$11.95
9-620225-670	1" Flag Holder	1 H in	Each	\$13.95
9-864685-670	Roller Brackets (Pair)	1 H in	Each	\$29.95



### Advantus Grip-A-Strip Display Rails

Designed for holding paper, posters, and other items up to 1/8 inch thick with a patented roller system. Display rail includes brackets or tape for mounting.

Item #	Product Dimensions	Material	Quantity	List Price
9-1334039-670	1 H x 12 W in	Aluminum	Each	\$23.09
9-1334040-670	1 H x 24 W in	Aluminum	Each	\$46.49
9-2049910-670	1 H x 36 W in	Aluminum	Each	\$47.69
9-1334041-670	3 H x 48 W in	Aluminum	Each	\$74.95
5-1334042-670	3 H x 96 W in	Aluminum	Each	\$118.95





**Post-it® Flex Write Surface**

Gives you the flexibility to instantly transform your work surface into a whiteboard and the freedom to write with even a permanent marker without stains. Long-term planning is easier than ever with the use of permanent markers to prevent accidental smearing and erasing. Permanent marker wipes away with water, and you can remove writing from a dry-erase marker with a cloth. With just three easy steps, this whiteboard surface is simple to use to capture your classroom's ideas, inspire creative thinking and track projects. First, unroll the whiteboard surface, peel off the backing, and then stick to your work surface. The flexible whiteboard removes cleanly with no damage to your wall or repurposed blackboard.

Item #	Product Dimensions	Color	Quantity	List Price
9-2026869-670	4 H x 3 W ft	White	Each	\$226.39
9-2026880-670	50 H x 4 W ft	White	Each	\$2,590.89

Use dry erase and permanent markers



**Post-it® Super Sticky Dry Erase Surface**

Transform painted dry wall, glass, painted steel, finished wood or even old dry erase and chalk boards into a dry erase surface with the Post-it® Super Sticky Dry Erase Surface. Easily turn vertical and horizontal surfaces into dry erase surfaces. Peel and stick construction sticks securely and removes cleanly. The stain-proof technology on these high-performance surfaces provides great writability as well as erasability. Satisfaction guaranteed.

Item #	Description	Product Dimensions	List Price
9-1502500-670	Post-it Dry Erase Sheet	2 H x 3 W ft	\$57.95
9-1502501-670	Post-it Dry Erase Sheet	3 H x 4 W ft	\$98.95
9-1502502-670	Post-it Dry Erase Sheet	4 H x 6 W ft	\$195.95
9-1502503-670	Post-it Dry Erase Sheet	4 H x 8 W ft	\$260.95
9-1502504-670	Cleaning Cloth	10-5/8 x 10-5/8 in	\$7.99
9-1502505-670	Accessory Tray	8-2/5 L x 3 D x 5-1/5 H in	\$15.99



**MooreCo® Sharewall - Full Wall Whiteboard Panel System**

The Sharewall Full Wall Whiteboard Panel System allows you to create a user-friendly and elegant room-sized presentation surface specially designed for versatile multimedia productions. It is fully trimmed in anodized aluminum for a clean and modern appearance. Durable surface and erases cleanly.



MOORECO



PRODUCT CERTIFIED FOR LOW CHEMICAL EMISSIONS: UL COMIGG UL 2818



Item #	Description	Product Dimensions	Color	List Price
6-1595168-670	Wall Whiteboard	8 H x 8 W ft	Gloss White	\$4,771.95
6-1577937-670	Wall Whiteboard	8 H x 12 W ft	Gloss White	\$6,458.95
6-1595169-670	Wall Whiteboard	8 H x 16 W ft	Gloss White	\$8,205.95

**MooreCo®  
Porcelain Steel Self-Adhesive Whiteboard Skins**

Replace or renew any torn or worn board with magnetic dry erase Porcelain Steel Self-Adhesive Skins, designed to make markerboard resurfacing easy, with no mess or fumes. Standard gloss porcelain provides superior writability and erasability with no ghosting. Reduced surface light distortion enhances visibility to provide optimum eye comfort.

Self-adhesive skins feature a peel-and-stick backing that applies easily to an existing board. Writable and erasable cover bar available to hide seams.

**CAUTION:** Self-stick adhesive is intended for resurfacing on an existing board surface and has not been tested for use on other materials.

Ask your local sales representative how to order custom sizes!

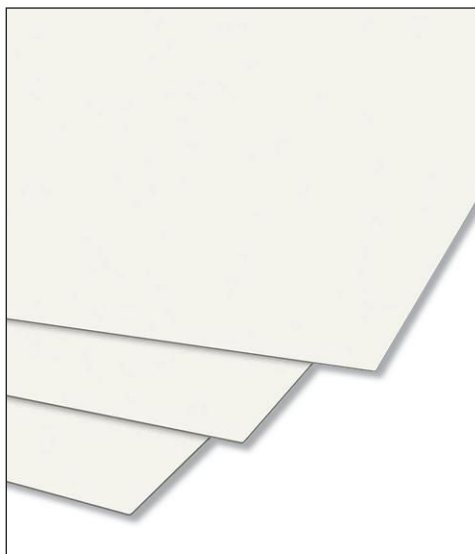

Item #	Description	Product Dimensions	Cut Size	List Price
<b>24 Gauge Steel</b>				
6-1582483-670	Porcelain on 24 Gauge Steel	4 W x 4 H ft	Specify	\$379.95
6-1582484-670	Porcelain on 24 Gauge Steel	6 W x 4 H ft	Specify	\$569.95
6-1582485-670	Porcelain on 24 Gauge Steel	8 W x 4 H ft	Specify	\$759.95
6-1582486-670	Porcelain on 24 Gauge Steel	10 W x 4 H ft	Specify	\$949.95
6-1582487-670	Porcelain on 24 Gauge Steel	12 W x 4 H ft	Specify	\$1,138.95



**MooreCo® Retro-Finish  
Whiteboard Resurfacing Panel with Frame**

Retro-Finish Panels make short work of resurfacing any old chalkboard or markerboard. No need to remove the existing board. Simply drill the Retro-Finish Panel directly into the old board. Factory framed panels come with pre-drilled holes to make mounting easy. Surface is durable porcelain steel for a superior dry erase surface. Low gloss porcelain provides superior writability and erasability with no ghosting. Reduced surface light distortion enhances visibility to provide optimum eye comfort. Mangets not included. Ask your local sales representative how to order custom sizes!

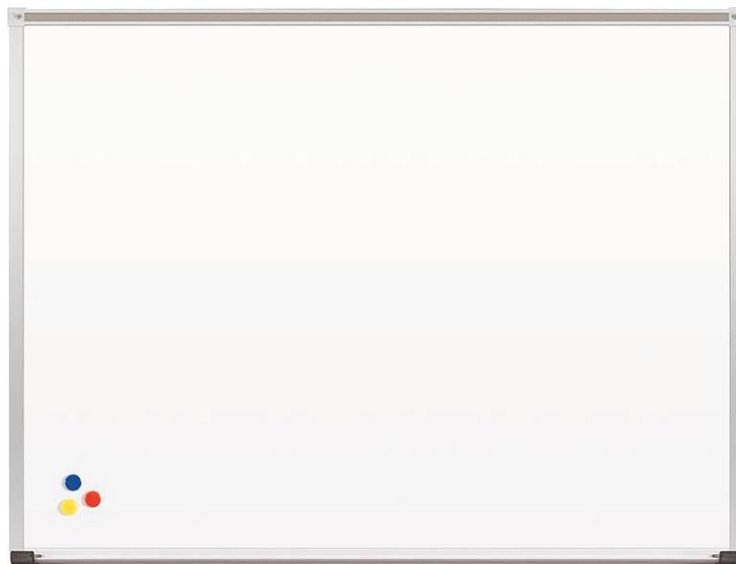

Item #	Description	Product Dimensions	Cut Size	List Price
6-1582473-670	Markerboard Skin with Frame	4 W x 4 H ft	Specify	\$435.95
6-1582474-670	Markerboard Skin with Frame	6 W x 4 H ft	Specify	\$653.95
6-1582475-670	Markerboard Skin with Frame	8 W x 4 H ft	Specify	\$872.95
6-1582476-670	Markerboard Skin with Frame	10 W x 4 H ft	Specify	\$1,090.95
6-1582477-670	Markerboard Skin with Frame	12 W x 4 H ft	Specify	\$1,308.95





**MooreCo® Visionary™  
Move Magnetic Glass Markerboard**

Ultra durable double-sided glass magnetic markerboard is a contemporary communication tool providing the highest quality writing and erasing experience.

- Smooth finish accepts dry erase, wet erase, chalk, markers and more and includes black surface markers
- Frame and trim are made with platinum powder-coated steel for superior durability
- Wide base design for stability includes dual-wheel locking casters
- Assembles at either 60.5"H or 75.25"H for ideal viewing
- Only accepts rare earth magnets, four are included

Item #	Description	Product Dimensions	Frame Color	List Price
6-5009306-670	Colored Magnetic Glass Board	3 W x 4 H ft	Platinum	\$2,785.95
6-5009307-670	Colored Magnetic Glass Board	6 W x 4 H ft	Platinum	\$5,196.95

**MooreCo® Hierarchy Grow and Roll Mobile Glassboard**

Ideal for use in collaborative learning environments, the dual-sided magnetic glass markerboard allows for multiple users, while the floor to stand surface maximizes use. Moves easily wherever you want it! Choose the color that will accent the design of your environment. Only accepts rare earth magnets, four are included.

Item #	Description	Product Dimensions	Color	Frame Color	List Price
5-5002391-670	Mobile Glass Panel	4 W x 3 H ft	Specify	Aluminum	\$2,010.95
5-2021357-670	Mobile Glass Panel	4 W x 3 H ft	Low Iron White	Aluminum	\$2,175.95
6-5002392-670	Mobile Glass Panel	4 W x 6 H ft	Specify	Aluminum	\$3,474.95
6-2021358-670	Mobile Glass Panel	4 W x 6 H ft	Low Iron White	Aluminum	\$3,491.95



Also Available in White Glass

**MooreCo® Visionary™ Curve Mobile Magnetic Glass Markerboard**

Get up to twice the functional space of a wall-mounted board with a versatile and stylish Visionary Curve Mobile Magnetic Glass Markerboard.

- Panel is beautiful and modern double-sided magnetic glass
- Provides you with style as well as a surface that provides unmatched writability and erases without ghosting
- Tempered safety glass surface measures 43.9"H x 30.6"W
- Frame and trim are made with white powder-coated steel for superior durability
- Wide base design for stability includes dual-wheel locking casters
- Only accepts rare earth magnets, four are included

Item #	Description	Product Dimensions	Color	Frame Color	List Price
6-1595174-670	Colored Glass Magnetic Board	35-1/2 W x 69-3/8 H in	Specify	White	\$2,041.95
6-1595173-670	White Glass with White Frame	35-1/2 W x 69-3/8 H in	Low Iron White	White	\$2,306.95



**MooreCo™ Visionary Glass Board**





PRODUCT CERTIFIED FOR LOW CHEMICAL EMISSIONS: UL.COM/IGG UL 2818

### Classroom Select Mobile Double Sided Markerboard

This mobile and magnetic dry erase board has a double sided writing surface. Available with a marker tray that is secured to the bottom of the board for easy organization. The markerboard is sturdy and easy to assemble. Magnetic board with anodized aluminum trim in titanium color. Mobility allows for ease when moving to and from any classroom or administration meeting. Wide base design is ideal for stability with heavy duty locking casters.

Item #	Description	Product Dimensions	Color	List Price
6-2104603-670	Double Sided Markerboard	38 W x 54 H in	Titanium	\$594.95

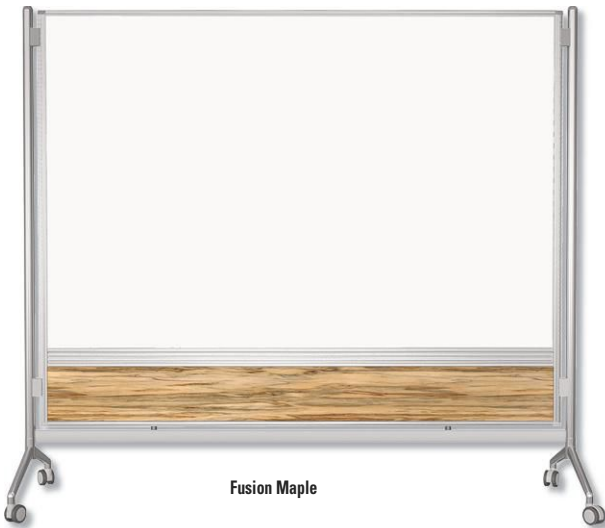
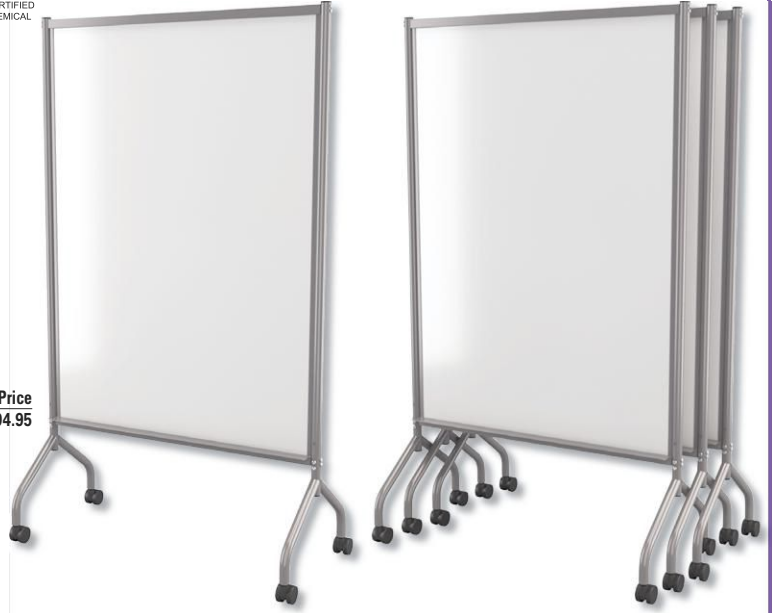

Fusion Maple



Gray Elm



### MooreCo® D.O.C. Glass Room Dividers

Pairing elegant magnetic glass whiteboard with a mobile aluminum frame, D.O.C. Glass Room Dividers allow you the freedom to divide, organize, and customize your space to fit your individual needs. These modular panels move wherever needed. Locking swivels caster help keep them in place. The glass is backed with steel to accept rare earth magnets for even more functionality and four magnets are included with your purchase. Please choose kickplate color when ordering

Item #	Description	Product Dimensions	Color	Frame Color	List Price
6-5000339-670	DOC Glass Room Divider	4 W x 6 H ft	Specify	Silver	\$3,145.95
6-5000338-670	DOC Glass Room Divider	6 W x 6 H ft	Specify	Silver	\$4,099.95

#### Doc Glass Room Divider Color



Low Line    Gray Elm    Asian Night    Amber Cherry    Castle Oak    Fusion Maple    Graphite Nebula    Gray Nebula



PRODUCT CERTIFIED FOR LOW CHEMICAL EMISSIONS: UL.COM/GG UL 2818



**Classroom Select® Mobile Makerspace Markerboard**

The Classroom Select® Mobile Makerspace Markerboard is perfect for any type of project, featuring a durable steel frame, a 2-sided 40" W X 30" H magnetic markerboard panel, and optional sliding tote rails for use with Geode Series® storage tote trays. Worksurface tables height adjusts from 16-36", on 1" increments, accommodating a wide range of student age groups. Generously sized worksurface, 24"D x 40"W", in your choice of Laminate or Markerboard with T-Mold or LockEdge® edging. Markerboard bottom tray allows for convenient storage of markerboard writing utensils. Heavy-duty, 2-inch locking casters makes mobility simple. Side panel hooks are perfect for storing the Classroom Select® Portable Markerboards, sold separately.



Without Geode Series Tote Rails



With Geode Series Tote Rails



PLEASE SPECIFY COLOR CHOICE  
Please refer to page 60-61 for all color selections.

Item #	Product Dimensions	Top Type	Top Color	Edge Color	List Price
<b>Without Geode Series Tote Rail</b>					
6-5008771-670	68-1/2Hx40Wx24D T-Mold Edge	Laminate	Specify	Specify	\$958.95
6-5008773-670	68-1/2Hx40Wx24D T-Mold Edge	Markerboard	White	Specify	\$979.95
6-5008805-670	68-1/2Hx40Wx24D LockEdge	Laminate	Specify	Specify	\$992.95
6-5008806-670	68-1/2Hx40Wx24D LockEdge	Markerboard	White	Specify	\$1,019.95
<b>With Geode Series Tote Rail</b>					
6-5008778-670	68-1/2Hx40Wx24D T-Mold Edge	Laminate	Specify	Specify	\$1,111.95
6-5008781-670	68-1/2Hx40Wx24D T-Mold Edge	Markerboard	White	Specify	\$1,131.95
6-5008776-670	68-1/2Hx40Wx24D LockEdge	Laminate	Specify	Specify	\$1,236.95
6-5008774-670	68-1/2Hx40Wx24D LockEdge	Markerboard	White	Specify	\$1,169.95
Item #	Description	Product Dimensions	Color	List Price	
<b>Portable Markerboard</b>					
5-5003880-670	Portable Markerboard Set of 4	18 W x 1/2 D x 23 H in	Specify	\$435.95	



**MooreCo® Nest Easel**

- Height adjusts from 65" - 72"
- Double sided dry-erase surface
- Full length marker tray on each side
- Height adjustable perforated steel storage box for books, maps, plans, and accessories
- Flip chart hooks provided on each side
- Four 2" casters included - 2 locking
- Writing surface is 41"H x 28 3/4"W
- Available in silver or black powder-coated steel, with a porcelain magnetic erase surface



MOORECO

Item #	Description	Product Dimensions	List Price
5-675188-670	Porcelain, Black Frame	31-1/2 W x 65 to 72 H in	\$1,124.95
5-1303249-670	Porcelain, Silver Frame	31-1/2 W x 65 to 72 H in	\$1,124.95

**Luxor Collaboration Station**

Transform your classroom into an interactive workspace with the Luxor Collaboration Station, a double-sided mobile magnetic whiteboard with four attachable marker boards. Designed to create a productive work environment where classmates can interact and share ideas, this mobile whiteboard's surface area is easily extended by attaching four small whiteboards to connectors on the sturdy steel frame. The double-sided small boards can be used individually and when not in use, are conveniently stored in the built-in storage tray. Whether visualizing ideas on the large whiteboard, with all five boards joined together, or using individual boards for group interaction, the Collaboration Station is the perfect tool to inspire innovation and creativity.



Item #	Description	Product Dimensions	Frame Material	List Price
6-2001194-670	LUXOR COLLABORATION STATION	82-1/4 W x 76-1/2 H in	Steel	\$1,554.95





4' x 6' Markerboard



40' x 30' Natural Cork

### MooreCo® Platinum Reversible Boards

Featuring sleek, contemporary design with a wide base design for added durability and stability. With twice the surface area of a wall mounted board, these mobile boards are ideal for presentations, meetings or training. A variety of surface combinations add versatility. Both the porcelain surface option as well as the perforated steel accent panel and full-length tray are magnetic. The boards have 3" locking casters. TAA compliant.

Item #	Description	Product Dimensions	Frame Material	List Price
<b>Porcelain Markerboard and Cork</b>				
6-677687-670	Porcelain Markerboard/Cork	30 W x 40 H in	Aluminum	\$1,662.95
6-677688-670	Porcelain Markerboard/Cork	6 W x 4 H ft	Aluminum	\$2,276.95
6-1433987-670	Porcelain Markerboard/Cork	8 W x 4 H ft	Aluminum	\$2,683.95
<b>Dura-Rite Markerboard and Cork</b>				
6-678649-670	Dura-Rite Markerboard/Cork	30 W x 40 H in	Aluminum	\$1,462.95
6-678650-670	Dura-Rite Markerboard/Cork	6 W x 4 H ft	Aluminum	\$2,171.95
6-1433992-670	Dura-Rite Markerboard/Cork	8 W x 4 H ft	Aluminum	\$2,684.95
<b>Double-Sided Porcelain Markerboard</b>				
6-677685-670	Porcelain Markerboard (2)	30 W x 40 H in	Aluminum	\$1,562.95
6-677686-670	Porcelain Markerboard (2)	6 W x 4 H ft	Aluminum	\$2,383.95
6-1433988-670	Porcelain Markerboard (2)	8 W x 4 H ft	Aluminum	\$2,629.95
<b>Double-Sided Dura-Rite Markerboard</b>				
6-677689-670	Dura-Rite Markerboard (2)	30 W x 40 H in	Aluminum	\$1,369.95
6-677690-670	Dura-Rite Markerboard (2)	6 W x 4 H ft	Aluminum	\$1,833.95
6-1433993-670	Dura-Rite Markerboard (2)	8 W x 4 H ft	Aluminum	\$2,186.95

### MooreCo® Deluxe Reversible Boards

Deluxe Reversible Boards provide twice the functional surface of a wall-mounted board. Mobile boards are double-sized and available in a variety of surface combinations. Surface rotates 360 degrees on a pivot hinge and locks into place with the turn of a knob. Wide base design for stability includes 3" locking casters.

Item #	Description	Product Dimensions	Frame Material	List Price
<b>Porcelain Markerboard and Cork</b>				
6-675693-670	Porcelain Markerboard/Cork	30 W x 40 H in	Aluminum	\$1,216.95
6-675672-670	Porcelain Markerboard/Cork	5 W x 4 H ft	Aluminum	\$1,684.95
6-675682-670	Porcelain Markerboard/Cork	6 W x 4 H ft	Aluminum	\$1,775.95
6-1397325-670	Porcelain Markerboard/Cork	8 W x 4 H ft	Aluminum	\$2,189.95
<b>Dura-Rite Markerboard and Cork</b>				
6-675668-670	Dura-Rite Markerboard/Cork	30 W x 40 H in	Aluminum	\$1,017.95
6-675674-670	Dura-Rite Markerboard/Cork	5 W x 4 H ft	Aluminum	\$1,614.95
6-675687-670	Dura-Rite Markerboard/Cork	6 W x 4 H ft	Aluminum	\$1,625.95
6-1397327-670	Dura-Rite Markerboard/Cork	8 W x 4 H ft	Aluminum	\$1,912.95
<b>Double-Sided Porcelain Markerboard</b>				
6-675692-670	Porcelain Markerboard (2)	30 W x 40 H in	Aluminum	\$1,190.95
6-675669-670	Porcelain Markerboard (2)	5 W x 4 H ft	Aluminum	\$1,527.95
6-675676-670	Porcelain Markerboard (2)	6 W x 4 H ft	Aluminum	\$1,695.95
6-1397324-670	Porcelain Markerboard (2)	8 W x 4 H ft	Aluminum	\$2,028.95
<b>Double-Sided Dura-Rite Markerboard</b>				
6-675694-670	Dura-Rite Markerboard (2)	30 W x 40 H in	Aluminum	\$933.95
6-675673-670	Dura-Rite Markerboard (2)	5 W x 4 H ft	Aluminum	\$1,283.95
6-675685-670	Dura-Rite Markerboard (2)	6 W x 4 H ft	Aluminum	\$1,304.95
6-1397326-670	Dura-Rite Markerboard (2)	8 W x 4 H ft	Aluminum	\$1,627.95





MOORECO

**MooreCo® The Wheasel®**

- Double sided dry-erase surface
- Equipped on both sides with pegs for flip chart use and accessory tray
- Height adjustable in two positions: 59 1/2" or 65"H
- Extra large storage shelf
- 2" locking casters for mobility included

Item #	Description	Product Dimensions	List Price
9-661713-670	The Wheasel, Melamine	28-3/4W x 27D x 59-1/2-65H in	\$713.95
9-663286-670	The Wheasel, Porcelain Steel	28-3/4W x 27D x 59-1/2-65H in	\$1,002.95



MOORECO

**MooreCo® Ogee Curved Easel**

The curved whiteboard surface on the Ogee Curved Easel maximizes the use of the writing surface while giving it a sleek high end design look. Surface measures 72"H x 36"W. Curved bottom makes writing on the lower portion of the board easier. Middle storage tray also functions as a handle to easily move the Ogee around wherever it's needed. Great for space division. Boards nest using the handle. Comes standard with a marker tray, and bottom shelf provides storage space.

Item #	Description	Product Dimensions	List Price
6-2021403-670	Porcelain Steel Easel	36-1/2W x 23-1/2D x 74-1/4H in	\$2,072.95

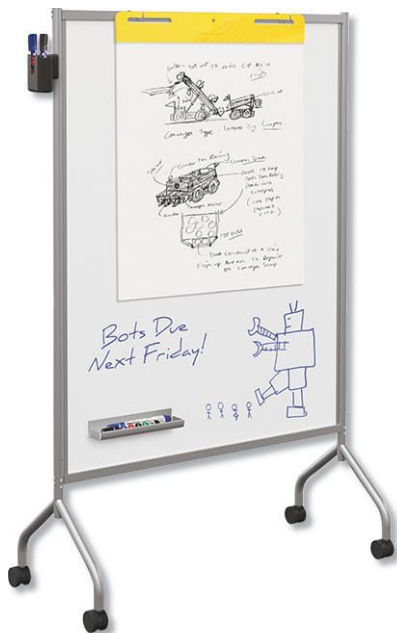

MOORECO

**Essentials™ by MooreCo® Mobile Whiteboard Easel**

The mobile markerboard is available with a magnetic surface to fit any need or environment. Includes double sided dry erase whiteboard writing surfaces, each measuring 38-1/2 x 54. Flip chart hooks included. Hooks can be adjusted from 2-1/4 to 37-1/2 inches apart. Marker cup that can be attached to the frame also included. Wide base design provides stability and heavy duty locking casters give you easy mobility.

Item #	Description	Product Dimensions	Frame Material	List Price
5-2006843-670	Magnetic, Platinum Frame	42 W x 71 3/4 H in	Anodized Aluminum	\$1,203.95



**Flipside Adjustable Easel**

Multi-use, height adjustable easel offers presentation options that can be taken anywhere. Sleek 1/2" aluminum frame surrounds a non-ghosting dry-erase board. Bottom marker tray spans the entire width of the easel and will support posters or large format books. Locking safety hinges ensure stability and fold for storage. Steel tubing legs feature anti-slip covers and are height adjustable for use on the floor or tabletop. Pressure-regulated steel strip along the top edge to hold tablets in place with thumbscrews. Perfect for any classroom!

Item #	Description	Product Dimensions	List Price
6-2104131-670	Adjustable Dry Erase- White	27-1/2 W x 29-1/2 D x 46 H in	\$328.95

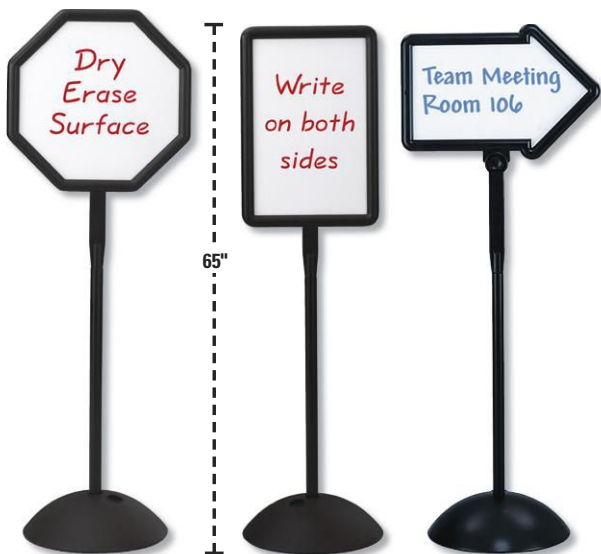

SAFCO®



**Safco® Write Way® Directional Signs**

Simply write your message on the attention-getting boards. Dual-sided white board surfaces allow messages to be displayed for traffic going in either direction. 18" wide base can be filled with sand or water for extra stability. Durable molded construction with UV inhibitors for indoor or outdoor use. Black finish. Easy to assemble.

Item #	Description	Product Dimensions	List Price
9-677044-670	Arrow Sign, Double-sided	25-1/2 W x 65H in	\$248.95
9-677045-670	Rectangle Sign, Double-sided	18 W x 65 H in	\$260.95
9-677046-670	Octagon Sign, Double-sided	22-1/2 W x 65 H in	\$263.95



**United Visual Econo Message Board**

A quick and economical message board. Panels attach to both sides. Order the A-Frame message board and then order either the Letter/Number kit for a changeable letter board, or order the Wet Erase kit for a markerboard. The Letter/Number kit includes 2 panels and a 350 piece letter/number set. The wet erase kit includes 2 panels and 5 markers. Collapses to 3 1/2" flat for easy storage.



Optional Letter/Number Kit

Item #	Description	Product Dimensions	List Price
9-1399642-670	Wet Erase Panel Kit	22 W x 28 H in	\$315.95
9-1399640-670	A-Frame Panel Holder	24 W x 36 H in	\$501.95
9-1399641-670	Letter and Number Panel Kit	22 W x 28 H in	\$599.95



**United Visual Kiosk Digital Signage**

These digital kiosks are a perfect companion to you school or auditorium entrance, or any common space that you need a digital sign. Built with BrightSign Software installed. They are easy to install and maintain, making it the perfect choice for any common area that needs a sign. Choose between the free standing or touchscreen free standing kiosk. The free standing allows you to feature built-in media while the touchscreen free standing kiosk allows your students to engage with different points of interaction and view your featured media.

Item #	Description	Product Dimensions	Frame Color	List Price
6-2018578-670	Free Standing 43" Display	25-3/4 W x 70-1/2 H in	Black	\$8,426.95
6-2018572-670	Touchscreen 43" Display	25-3/4 W x 70-1/2 H in	Black	\$8,502.95
6-2018575-670	Free Standing 49" Display	28-4/5 W x 72-1/2 H in	Black	\$8,577.95
6-2018577-670	Touchscreen 49" Display	28-4/5 W x 72-1/2 H in	Black	\$9,401.95
6-2018576-670	Free Standing 55" Display	41 W x 88 H in	Black	\$10,032.95
6-2018574-670	Touchscreen 55" Display	41 W x 88 H in	Black	\$11,240.95



QUICKSHIP Items ship within 24 hrs, 48 hrs, 1 or 2 weeks as indicated when the factory distribution center receives the order.



See Shipping & Handling terms for details.



**MooreCo® Outdoor Enclosed Bulletin Board Cabinet**

Outdoor bulletin board cabinets feature heavy duty aluminum trim available in silver or coffee and have a 1.5" internal depth. Piano hinged doors feature shatter-resistant acrylic panels. Cabinets are built to be suited for outdoor use but should be mounted beneath overhang or in semi-enclosed space. Optional interior lighting kits are available. One kit per two linear feet of cabinet is recommended. Choose from natural cork or vinyl back panel. Please specify back panel color when ordering.



Item #	Product Dimensions	Number of Doors	Frame Color	Tackboard Color	List Price
6-1397363-670	18 W x 24 H in	1	Silver	Specify	\$425.95
6-1397364-670	24 W x 36 H in	1	Silver	Specify	\$693.95
6-1397365-670	30 W x 36 H in	1	Silver	Specify	\$756.95
6-1397366-670	36 W x 36 H in	1	Silver	Specify	\$766.95
6-1400096-670	48 W x 36 H in	2	Silver	Specify	\$1,047.95
6-1397367-670	60 W x 36 H in	2	Silver	Specify	\$1,433.95
6-1397368-670	72 W x 36 H in	3	Silver	Specify	\$1,637.95
6-1397369-670	72 W x 48 H in	3	Silver	Specify	\$1,847.95
6-1397370-670	96 W x 48 H in	3	Silver	Specify	\$2,530.95

**Vin-Tak Colors**



**MooreCo® Indoor Enclosed Bulletin Board Cabinet**

The indoor enclosed bulletin board cabinet features lockable piano hinged doors and shatter proof acrylic panels and has an internal depth of 1.5". The elegant trim is available in silver aluminum. Available with natural cork or vinyl tackable back panels. Please specify back panel color when ordering. TAA compliant.



Item #	Product Dimensions	Number of Doors	Frame Color	Tackboard Color	List Price
6-1397328-670	18 W x 24 H in	1	Silver	Specify	\$394.95
6-1397329-670	24 W x 36 H in	1	Silver	Specify	\$570.95
6-1397330-670	30 W x 36 H in	1	Silver	Specify	\$702.95
6-1397331-670	36 W x 36 H in	1	Silver	Specify	\$712.95
6-1397332-670	48 W x 36 H in	2	Silver	Specify	\$960.95
6-1397333-670	60 W x 36 H in	2	Silver	Specify	\$1,331.95
6-1397334-670	72 W x 36 H in	3	Silver	Specify	\$1,521.95
6-1397335-670	72 W x 48 H in	3	Silver	Specify	\$1,716.95
6-1397336-670	96 W x 48 H in	3	Silver	Specify	\$2,276.95

**Indoor Bulletin Board Vin-Tak Colors**



More Options Available Online!

**Ghent® Indoor Enclosed Bulletin Boards**

Keep posted material neat and protected from vandalism by controlling access to the posting surface. Ghent Enclosed Bulletin Boards are made with fine quality natural cork enclosed in anodized Aluminum or Natural Oak wood hardwood frames.

The Ghent Header Bulletin Boards are framed in anodized Aluminum and feature a 6" high white acrylic header panel to identify your organization. All boards are available in one, two, or three door units with shatter resistant acrylic construction, disc tumbler locks and two keys per lock. Exterior depth is 2 1/4" and Interior depth is 1 5/16".



Item #	Description	Product Dimensions	Door Type	Number of Doors	Frame Color	Tackboard Color	Headline Panel	List Price
6-1335460-670	Indoor Bulletin Board, Encl	72 W x 48 H in	Hinged	3	Satin	Corkboard	6 in White Acrylic	\$2,452.95
6-1335461-670	Indoor Bulletin Board, Encl	96 W x 48 H in	Hinged	3	Satin	Corkboard	6 in White Acrylic	\$3,115.95



Countertop Case

### Waddell® Heritage Series Cases

These wooden display cases offer such premium features as sliding tempered glass doors, built-in locks, steel shelving hardware and floor levelers. Also available with a cornice lighting fixture for an enhanced presentation. Choose from 4 finish options and 3 back options. TAA Compliant.

Item #	Description	Product Dimensions	Back Color	Finish Color	List Price
6-1364104-670	Countertop Case, Hardwood	36 W x 14 D x 40 H in	Specify	Specify	\$1,927.95
6-1364314-670	Floor Case, Hardwood	48 W x 18 D x 70 H in	Specify	Specify	\$3,259.95
6-1596091-670	Illuminated Floor Case	48 W x 18 D x 76 H in	Specify	Specify	\$4,566.95



### Waddell® Reliant Series Cases

The Waddell Reliant Series combines the strength and durability of aluminum with the engaging look of wood. Anodized aluminum framing secures the sliding tempered glass doors and built-in lock. Ideal for either traditional or contemporary settings. Choose from 3 finish options, 3 trim options and 3 back options. TAA Compliant.

Item #	Description	Product Dimensions	Trim Color	Back Color	Finish Color	List Price
A 6-5000977-670	Display Case	36 W x 14 D x 40 H in	Specify	Specify	Specify	\$2,926.95
B 6-5000980-670	Display Case	48 W x 16 D x 72 H in	Specify	Specify	Specify	\$5,184.95
6-5000978-670	Display Case	60 W x 16 D x 72 H in	Specify	Specify	Specify	\$6,187.95
6-5000982-670	Display Case	72 W x 16 D x 72 H in	Specify	Specify	Specify	\$6,779.95
C 6-5000979-670	Lighted Display Case	48 W x 16 D x 80 H in	Specify	Specify	Specify	\$6,106.95
6-5000981-670	Lighted Display Case	60 W x 16 D x 80 H in	Specify	Specify	Specify	\$7,302.95
6-5000976-670	Lighted Display Case	72 W x 16 D x 80 H in	Specify	Specify	Specify	\$8,114.95

### Waddell® Spirit Series

The Spirit Case combines the strength and durability of aluminum with the beauty of vivid school colors. Case includes sliding tempered glass doors, built in locks and includes four (4) 14" deep adjustable half shelves with brackets. Choose from 10 color options, 3 trim options and 3 back options. TAA Compliant.

Item #	Description	Product Dimensions	Trim Color	Back Color	Finish Color	List Price
6-1399722-670	Floor Case	48 W x 16 D x 72 H in	Specify	Specify	Specify	\$5,080.95
6-1399723-670	Floor Case	60 W x 16 D x 72 H in	Specify	Specify	Specify	\$5,488.95
6-1399724-670	Floor Case	72 W x 16 D x 72 H in	Specify	Specify	Specify	\$5,981.95
6-5003782-670	Lighted Floor Case	48 W x 16 D x 80 H in	Specify	Specify	Specify	\$5,560.95
6-5003781-670	Lighted Floor Case	60 W x 16 D x 80 H in	Specify	Specify	Specify	\$6,637.95
6-5003784-670	Lighted Floor Case	72 W x 16 D x 80 H in	Specify	Specify	Specify	\$7,375.95



non-lighted case shown

lighted case shown



#### Waddell Heritage Hardwood Finishes

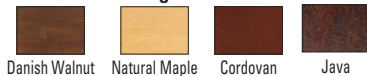

#### Waddell Trim Finishes



#### Waddell Reliant Finishes



#### Waddell Back Options



#### Waddell Spirit Colors





# common area - media



## Classroom Select® NeoFuse® Soft Seating

NeoFuse® Soft Seating offers comfortable multi-level seating ideal for lounge and atrium areas, classrooms, media centers, and flexible seating environments. Constructed of a durable wood frame and high-quality foam overlay. Enjoy the creativity and modular convenience of creating collaborative pods with stools, ottomans, two-and three-tier options plus the two-tier corner modules that can be configured to create a variety of seating spaces. NeoFuse® is offered standard as one-color fabric, however, customs are available.

**CLASSROOM  
SELECT** 

 PLEASE  
SPECIFY  
**COLOR  
CHOICE**

Refer to pages 60-61  
for color options.

Item #	Description	Color	Product Dimensions	List Price
A 6-5000931-670	Tapered Ottoman	Specify	20-1/2 W x 20-1/2 D x 24 H in	\$619.95
B 6-5000935-670	20" Round Ottoman	Specify	20 Dia x 18 H in	\$634.95
B 6-5000933-670	24" Round Ottoman	Specify	24 Dia x 18 H in	\$735.95
B 6-5003003-670	30" Round Ottoman	Specify	30 Dia x 18 H in	\$864.95
B 6-5003024-670	36" Round Ottoman	Specify	36 Dia x 18 H in	\$1,037.95
B 6-5003015-670	42" Round Ottoman	Specify	42 Dia x 18 H in	\$1,207.95
C 6-5000940-670	3-Tiered Seat	Specify	37 W x 41 D x 35 H in	\$1,653.95
D 6-5000934-670	3-Tier Out Wedge	Specify	47-1/2 W x 40-1/4 D x 35 H in	\$1,777.95
E 6-5000930-670	3-Tier In Wedge	Specify	47-1/2 W x 40-1/4 D x 35 H in	\$1,873.95
F 6-5000938-670	2-Tiered Seat	Specify	37 W x 41 D x 35 H in	\$1,552.95

Item #	Description	Color	Product Dimensions	List Price
G 6-5000929-670	2-Tier Out Wedge	Specify	47-1/2 W x 40-1/4 D x 35 H in	\$1,777.95
H 6-5000928-670	2-Tier In Wedge	Specify	47-1/2 W x 40-1/4 D x 35 H in	\$1,873.95
I 6-5000939-670	2-Tier In Corner	Specify	37 W x 41 D x 35 H in	\$1,649.95
J 6-5000941-670	2-Tier Out Corner	Specify	37 W x 41 D x 35 H in	\$1,561.95
K 6-5000936-670	32" Octagonal Ottoman	Specify	32 W x 32 D x 18 H in	\$1,524.95
L 6-5000932-670	2-Seat Bench	Specify	42 W x 20 D x 18 H in	\$717.95
M 6-5004749-670	3 Pack Nesting Bench	Specify	69 W x 57 D x 24 H in	\$3,284.95
N 6-5004750-670	Small Bench	Specify	20-1/2 W x 32-1/2 D x 12 H in	\$763.95
N 6-5004751-670	Medium Bench	Specify	22-1/2 W x 44 D x 18 H in	\$1,048.95
N 6-5004752-670	Tall Bench	Specify	24-1/2 W x 57 D x 24 H in	\$1,471.95
O 6-5004343-670	Twirl Ottoman	Specify	32 W x 16 D x 18 H in	\$400.95
P 6-5004344-670	8 PC Twirl Set	Specify	76-1/2 W x 76-1/2 D x 18 H in	\$3,204.95

For more color options, please contact your Sales Rep.



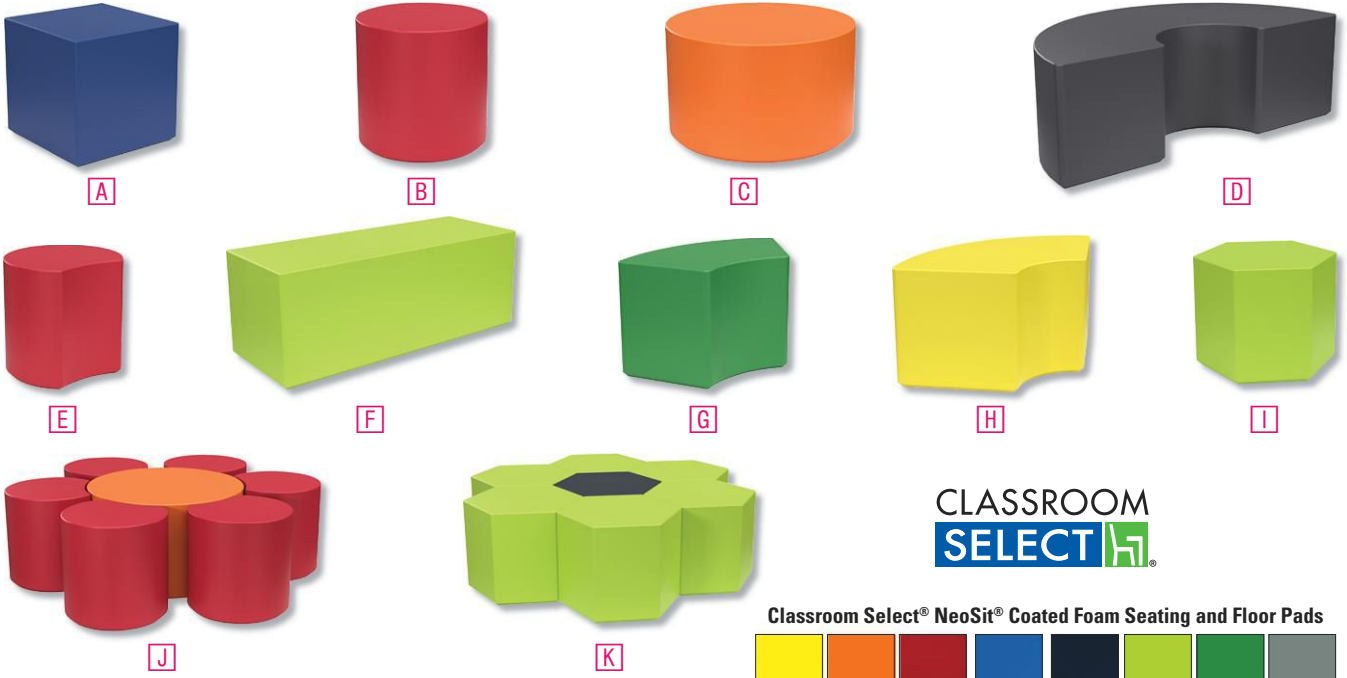

**CLASSROOM  
SELECT** 

**Classroom Select® NeoSit® Coated Foam Seating and Floor Pads**

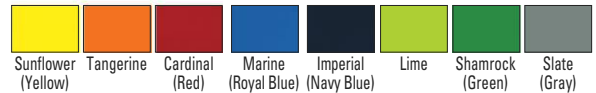

**Classroom Select® NeoSit® Coated Foam Seating**

Perfect for any school lounge area, atrium, classroom, administration offices, libraries or even hallways! NeoSit® medium-density, polyurethane foam has a silicone non-stick coating, that is difficult to stain or mark. The surface is easy to clean with most cleaning products, including bleach and other anti-microbial cleaners. There are no sewing seams to trap dirt, germs, or contaminants. NeoSit® is soft and safe for younger students, yet durable and firm enough for middle and high school students. Easy for teachers to reconfigure any learning environment quickly. Available in eight exciting colors!

Item #	Description	Color	Product Dimensions	List Price
A 6-5004754-670	Square Ottoman	Specify	18 W x 18 D x 18 H in	\$349.95
B 6-5004755-670	Round Ottoman	Specify	18 W x 18 D x 18 H in	\$370.95
C 6-5004756-670	Round Ottoman	Specify	30 W x 30 D x 18 H in	\$763.95
D 6-5004757-670	Half Round Ottoman	Specify	54 W x 27 D x 18 H in	\$872.95
E 6-5004758-670	Crescent Ottoman	Specify	18 W x 18 D x 18 H in	\$315.95
F 6-5004759-670	Bench Ottoman	Specify	48 W x 18 D x 18 H in	\$752.95
G 6-5004760-670	Arc Ottoman	Specify	38 W x 18 D x 18 H in	\$668.95
H 6-5004761-670	1/4 Round Ottoman	Specify	27 W x 18 D x 18 H in	\$443.95
I 6-5004762-670	Hexagon Ottoman	Specify	24 W x 26 D x 18 H in	\$352.95
J 6-5004763-670	Flower 7 Piece Set	Specify	53-1/2 W x 59-1/4 D x 18 H in	\$2626.95
K 6-5004764-670	Hex 7 Piece Set	Specify	60 W x 62-1/2 D x 18 H in	\$2438.95

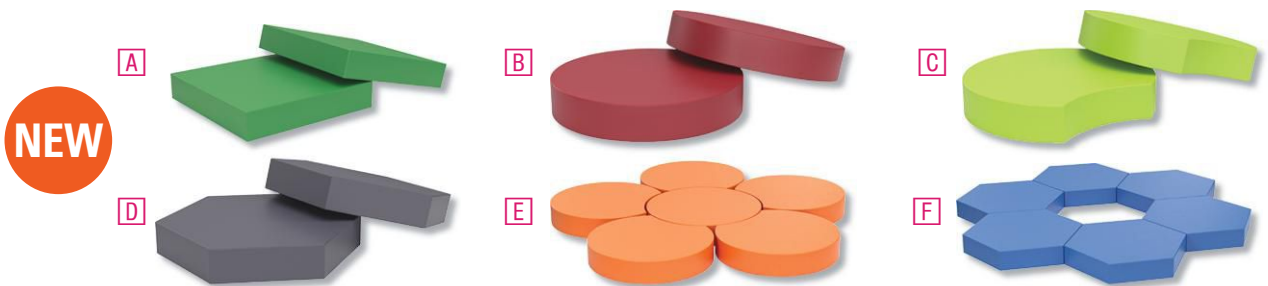

**Classroom Select® NeoSit® Coated Foam Floor Pads**

Classroom Select® NeoSit® Coated Foam Floor Pads make floor learning more comfortable and focused. Constructed of medium-density, polyurethane foam with a silicone non-stick coating, that is difficult to stain or mark. The easy-to-clean surfaces make these a perfect addition to any learning environment. The glossy bottom provides a superior non-slip surface, to keep seating pads in place. No sewing seams to trap dirt, germs, or contaminants. Conveniently stow seat pads with the Classroom Select® Floor Pad Cart, sold separately.

Item #	Description	Color	Product Dimensions	List Price
A 6-5009515-670	Square - Set of 2	Specify	16 W x 16 D x 3 H in	\$212.95
B 6-5009505-670	Round - Set of 2	Specify	16 W x 16 D x 3 H in	\$203.95
C 6-5009512-670	Crescent - Set of 2	Specify	16 W x 16 D x 3 H in	\$203.95
D 6-5009508-670	Hex - Set of 2	Specify	16 W x 18-1/2 x 3 H in	\$212.95
E 6-5009517-670	Flower Set - 6 Piece Set	Specify	42 W x 41 D x 3 H in	\$610.95
F 6-5009506-670	Hex Set - 6 Piece Set	Specify	47-1/2 W x 46 D x 3 H in	\$639.95



PLEASE SPECIFY COLOR CHOICE  
Refer to pages 60-61 for color options.

Classroom Select® NeoLink® Laminate Colors



**Classroom Select® NeoLink® Soft Seating**

NeoLink® Soft Seating has all the pieces you need to create any space, anywhere; media centers, classrooms, libraries, common areas, and even hallways. Soft seating pieces are constructed with a wood frame and high-quality foam for stability and comfort. This series will transform any space into a comfortable, inviting environment. Pairs perfectly with the NeoLink® laminate shelving and tables. Legs are standard platinum finish. Majority of the NeoLink® series are available with optional power with 2 plugs and 2 USB ports. Power units are offered as under, front, left, right, and flush mount to ensure optimal usability.

**CHAIRS**



Description	Product Dimensions	Laminate Color	Seat Color	Non Powered Option		Power Options (listed by location)					
				No Power	List Price	Under	List Price	Front	Left	Right	List Price
1 Armless Chair	23 W x 32 D x 34 H in	–	Specify	6-1605241-670	\$1,324.95	6-5000133-670	\$1,793.95	6-5000142-670	6-5000167-670	6-5000152-670	\$1,872.95
2 Armless Chair w/Right Tablet	23 W x 32 D x 34 H in	Specify	Specify	6-1605242-670	\$1,951.95	6-5000135-670	\$2,344.95	6-5000146-670	6-5000165-670	6-5000153-670	\$2,393.95
2 Armless Chair w/Left Tablet	23 W x 32 D x 34 H in	Specify	Specify	6-1605243-670	\$1,951.95	6-5000134-670	\$2,344.95	6-5000147-670	6-5000166-670	6-5000154-670	\$2,393.95
3 Double Armless Chair w/Console	58 W x 32 D x 34 H in	Specify	Specify	6-5003014-670	\$4,079.95	–	–	6-5003013-670	–	–	\$4,471.95
4 Double Armed Chair w/Console	66 W x 32 D x 34 H in	Specify	Specify	6-5002999-670	\$4,640.95	–	–	6-5002997-670	–	–	\$5,032.95
5 Chair w/Arms	32 W x 32 D x 34 H in	–	Specify	6-1605244-670	\$1,883.95	6-5000138-670	\$2,352.95	6-5000144-670	6-5000168-670	6-5000157-670	\$2,431.95
6 Chair w/Right Arm Only	27 ½ W x 32 D x 34 H in	–	Specify	6-1605245-670	\$1,710.95	6-5000139-670	\$2,181.95	6-5000143-670	6-5000169-670	6-5000155-670	\$2,257.95
7 Chair w/Left Arm Only	27 ½ W x 32 D x 34 H in	–	Specify	6-1605246-670	\$1,710.95	6-5000131-670	\$2,181.95	6-5000145-670	6-5000170-670	6-5000156-670	\$2,257.95
8 Inside 45° Armless Chair	36 ½ W x 32 D x 34 H in	–	Specify	6-5002998-670	\$1,841.95	6-5003000-670	\$2,233.95	–	6-5003847-670	6-5003873-670	\$2,233.95
9 Outside 45° Armless Chair	36 ½ W x 32 D x 34 H in	–	Specify	6-5003006-670	\$1,736.95	6-5003029-670	\$2,128.95	–	6-5003849-670	6-5003871-670	\$2,128.95

**SOFAS**



Description	Product Dimensions	Laminate Color	Seat Color	Non Powered Option		Power Options (listed by location)					
				No Power	List Price	Under	List Price	Front	Left	Right	List Price
10 58" Armless Sofa	58 W x 32 D x 34 H in	–	Specify	6-1605247-670	\$2,267.95	6-5000132-670	\$2,740.95	6-5000148-670	6-5000172-670	6-5000158-670	\$2,815.95
11 78" Armless Sofa	78 W x 32 D x 34 H in	–	Specify	6-1605248-670	\$2,734.95	6-5000130-670	\$3,205.95	6-5000149-670	6-5000171-670	6-5000159-670	\$3,283.95
12 66" Armed Sofa	66 W x 32 D x 34 H in	–	Specify	6-1605249-670	\$2,844.95	6-5000136-670	\$3,317.95	6-5000150-670	6-5000176-670	6-5000162-670	\$3,394.95
13 86" Armed Sofa	86 W x 32 D x 34 H in	–	Specify	6-1605250-670	\$3,308.95	6-5000137-670	\$3,779.95	6-5000151-670	6-5000177-670	6-5000161-670	\$3,857.95

## BENCHES WITH BACKS



Description	Product Dimensions	Laminate Color	Seat Color	Non Powered Option		Power Options (listed by location)					
				No Power	List Price	Under	List Price	Front	Left	Right	List Price
14 56" High Back Armless	56 W x 29 1/2 D x 50 H in	–	Specify	6-5003010-670	\$3,480.95	6-5003026-670	\$3,873.95	6-5003863-670	6-5003869-670	6-5003860-670	\$3,874.95
15 56" High Back Armless w/Shelf	56 W x 29 1/2 D x 50 H in	Specify	Specify	6-5003754-670	\$4,480.95	6-5003755-670	\$4,888.95	6-5003872-670	6-5003862-670	6-5003865-670	\$4,843.95
16 67" High Back w/Arms	67 W x 29 1/2 D x 50 H in	–	Specify	6-5003023-670	\$4,586.95	6-5003007-670	\$4,987.95	6-5003848-670	6-5003857-670	6-5003867-670	\$4,945.95
17 67" High Back w/Arms & Shelf	67 W x 29 1/2 D x 50 H in	Specify	Specify	6-5003753-670	\$5,195.95	6-5003756-670	\$5,588.95	6-5003851-670	6-5003853-670	6-5003868-670	\$5,588.95
18 30" Curved High Back Armless	30 W x 42 D x 50 H in	–	Specify	6-5003790-670	\$2,773.95	6-5003796-670	\$3,177.95	–	6-5003870-670	6-5003866-670	\$3,155.95
19 30" Curved High Back Armless w/Shelf	30 W x 45 D x 50 H in	Specify	Specify	6-5003792-670	\$3,435.95	6-5003795-670	\$3,827.95	–	6-5003855-670	6-5003850-670	\$3,435.95
20 30" Curved Low Back Armless	30 W x 42 D x 29 H in	–	Specify	6-5003958-670	\$2,030.95	6-5003957-670	\$2,435.95	–	6-5003954-670	6-5003956-670	\$2,393.95
21 30" Curved Low Back Armless w/Shelf	30 W x 54 D x 29 H in	Specify	Specify	6-5003959-670	\$2,662.95	6-5003952-670	\$3,066.95	–	6-5003955-670	6-5003953-670	\$3,053.95
22 56" Low Back Armless	56 W x 29 D x 29 H in	–	Specify	6-5003912-670	\$2,316.95	6-5003915-670	\$2,708.95	6-5003910-670	6-5003909-670	6-5003913-670	\$2,708.95
23 56" Low Back Armless w/Shelf	56 W x 29 D x 29 H in	Specify	Specify	6-5003916-670	\$2,988.95	6-5003911-670	\$3,381.95	6-5003914-670	6-5003908-670	6-5003917-670	\$3,381.95
24 67" Low Back w/Arms	67 W x 29 D x 29 H in	–	Specify	6-5003926-670	\$3,045.95	6-5003920-670	\$3,652.95	6-5003918-670	6-5003921-670	6-5003924-670	\$3,609.95
25 67" Low Back w/Arms & Shelf	67 W x 29 D x 29 H in	Specify	Specify	6-5003927-670	\$3,718.95	6-5003922-670	\$4,110.95	6-5003925-670	6-5003919-670	6-5003923-670	\$4,110.95

## BENCHES



Description	Product Dimensions	Laminate Color	Seat Color	Non Powered Option		Power Options (listed by location)						
				No Power	List Price	Under	List Price	Front	Left	Right	Flush Mount Top	List Price
26 30" Bench	24 W x 32 D x 18 H in	–	Specify	6-1605251-670	\$1,253.95	–	–	–	6-5000173-670	6-5000160-670	–	\$1,739.95
27 60" Bench	48 W x 32 D x 18 H in	–	Specify	6-1605252-670	\$1,648.95	6-5000141-670	\$2,121.95	–	6-5000175-670	6-5000163-670	–	\$2,195.95
28 90" Bench	71 W x 32 D x 18 H in	–	Specify	6-1605253-670	\$2,181.95	6-5000140-670	\$2,230.95	–	6-5000174-670	6-5000164-670	–	\$2,296.95
29 45" Bench	36 W x 32 D x 18 H in	–	Specify	6-5003727-670	\$1,412.95	6-5003729-670	\$1,817.95	–	6-5004063-670	6-5004066-670	–	\$1,776.95
30 45" Bench w/Laminate Top	36 W x 32 D x 16 H in	Specify	Specify	6-5003730-670	\$1,617.95	6-5003728-670	\$2,021.95	–	6-5004065-670	6-5004064-670	6-5003854-670	\$1,998.95
31 23" Single Bench	23 W x 32 D x 18 H in	–	Specify	6-5003012-670	\$1,042.95	6-5002995-670	\$1,435.95	6-5003852-670	6-5003861-670	6-5003858-670	–	\$1,435.95
32 23" Single Bench w/Laminate Top	23 W x 32 D x 16 H in	Specify	Specify	6-5003009-670	\$1,031.95	6-5003020-670	\$1,424.95	6-5003856-670	6-5003864-670	6-5003874-670	6-5003859-670	\$1,424.95

## OTTOMANS & STOOLS

Description	Product Dimensions	Seat Color	Only Non Powered Option Available	
			No Power	List Price
33 36" Round Ottoman	36 Dia x 18 H in	Specify	6-5003028-670	\$1,104.95
34 18 H Square Stool	20 W x 20 D x 18 H in	Specify	6-5003017-670	\$415.95
34 24 H Square Stool	20 W x 20 D x 24 H in	Specify	6-5003025-670	\$475.95
34 30 H Square Stool	20 W x 20 D x 30 H in	Specify	6-5003018-670	\$528.95
35 24" Square Swivel Stool	18 W x 18 D x 24 H in	Specify	6-5008615-670	\$915.95
36 24" Round Swivel Stool	18 W x 18 D x 24 H in	Specify	6-5008617-670	\$915.95
35 30" Square Swivel Stool	18 W x 18 D x 30 H in	Specify	6-5008613-670	\$948.95
36 30" Round Swivel Stool	18 W x 18 D x 30 H in	Specify	6-5008612-670	\$948.95







PLEASE SPECIFY COLOR CHOICE  
Refer to pages 60-61 for color options.

Classroom Select® Neolink® Laminate Colors



HIGH BACKS



Description	Product Dimensions	Laminate Color	One Color			Two Color			
			Item #	Color	List Price	Item #	Color	Wall Color	List Price
37 Cubicle Chair No Power	40 W x 37 3/4 D x 52 H in	Specify	6-5004351-670	Specify	\$4,117.95	6-5004783-670	Specify	Specify	\$4,256.95
37 Cubicle Chair with Power	40 W x 37 3/4 D x 52 H in	Specify	6-5004350-670	Specify	\$4,093.95	6-5004784-670	Specify	Specify	\$4,624.95
38 Corner High Back No Power	32 W x 32 D x 50 H in	—	6-5004302-670	Specify	\$1,501.95	—	—	—	—
39 High Back Table with Power	32 W x 14 D x 50 H in	Specify	6-5004303-670	Specify	\$2,434.95	—	—	—	—

SHELVING AND TABLES



Description	Product Dimensions	Color	Markerboard Back		Laminate Back	
			Item #	List Price	Item #	List Price
40 35H Curved Mobile Cabinet Single Sided	73 W x 25 1/3 D x 35 H in	Specify	6-5004027-670	\$3,692.95	6-5004022-670	\$3,533.95
40 42H Curved Mobile Cabinet Single Sided	73 W x 25 1/3 D x 42 H in	Specify	6-5004021-670	\$4,057.95	6-5004028-670	\$3,894.95
41 35H Curved Mobile Cabinet Double Sided	73 W x 30 1/2 D x 35 H in	Specify	—	—	6-5004023-670	\$4,375.95
41 42H Curved Mobile Cabinet Double Sided	73 W x 30 1/2 D x 42 H in	Specify	—	—	6-5004026-670	\$4,407.95
42 35H Straight Mobile Cabinet Single Sided	56 W x 18 D x 35 H in	Specify	6-5004031-670	\$2,893.95	6-5004024-670	\$2,624.95
42 42H Straight Mobile Cabinet Single Sided	56 W x 18 D x 42 H in	Specify	6-5004029-670	\$2,903.95	6-5004030-670	\$3,083.95
43 35H Straight Mobile Cabinet Double Sided	56 W x 24 D x 35 H in	Specify	—	—	6-5004032-670	\$3,149.95
43 42H Straight Mobile Cabinet Double Sided	56 W x 24 D x 42 H in	Specify	—	—	6-5004025-670	\$3,337.95
44 29H Curved Table	73 W x 25 1/3 D x 29 H in	Specify	6-5003876-670	\$2,666.95	6-5004039-670	\$2,666.95
44 42H Curved Table	73 W x 25 1/3 D x 42 H in	Specify	6-5003875-670	\$2,863.95	6-5004042-670	\$2,863.95
45 29H Straight Table	56 W x 18 D x 29 H in	Specify	6-5003877-670	\$2,370.95	6-5004040-670	\$2,370.95
45 42H Straight Table	56 W x 18 D x 42 H in	Specify	6-5003878-670	\$2,567.95	6-5004041-670	\$2,567.95

WALLS



Description	Product Dimensions	Laminate Color	Fabric Color	Non Powered Option		Power Options (listed by location)						
				No Power	List Price	Under	Front	Left	Right	Flush Mount Top	List Price	
46 42" Media Wall	42 W x 60 D x 66 H in	Specify	Specify	6-5003901-670	\$3,739.95	—	6-5003902-670	—	—	—	—	\$3,975.95

Description	Product Dimensions	One Color			Two Color			
		Item #	Color	List Price	Item #	Color	Wall Color	List Price
47 Mobile X Privacy Wall with Casters	70 W x 70 D x 50 H in	6-5004349-670	Specify	\$3,133.95	6-5004753-670	Specify	Specify	\$3,435.95



### Classroom Select® NeoLounge® Soft Seating

Create flexible and collaborative spaces for teachers and students with NeoLounge® soft seating modular pieces. Choose from our expanded line of fabric colors and prints to mix and match to create spaces for common areas, classrooms, offices, and media centers!

All-foam construction makes these pieces easy to move and configure where seating is needed. 1/2" MDF base board with metal inserts for glides.

Single units (A-Z) can be ordered as one fabric color or two fabric color options. Customize two color options by choosing one color for the sides and another color for the top. **Quickship only available in one color options: Vinyl fabrics: Canter-Ink, Canter-Adobe, Canter-Red, and in Coated fabrics: Eon-Atlantic, Eon Spring, and Eon-Typographic.**

Sets (1-6) can be ordered as one color for all pieces or two color options. Sets with a center ottoman will be considered a two color option by choosing a color for the center and another color for the pieces surrounding the center. Sets with no center can be ordered as two colors with every other piece a different color (if two colors are selected for the Twist 5 piece set, one color is for the sides of all units and another color is for the top of all units).

Description	Product Dimensions	One Color			Two Color			
		Item #	Color	List Price	Item #	Top Color	Side Color	List Price
<b>A</b> Arrow Bench	72 W x 18 D x 18 H in	6-5008618-670	Specify	\$1,112.95	6-5008622-670	Specify	Specify	\$1,168.95
<b>B</b> Diamond Ottoman	36 W x 18 D x 18 H in	6-5008623-670	Specify	\$624.95	6-5008621-670	Specify	Specify	\$656.95
<b>C</b> Honeycomb Ottoman	24 W x 21 D x 18 H in	6-5008619-670	Specify	\$479.95	6-5008626-670	Specify	Specify	\$503.95
<b>D</b> Twist Ottoman	26 W x 24 D x 18 H in	6-5008632-670	Specify	\$474.95	6-5008633-670	Specify	Specify	\$498.95
<b>E</b> Wedge Ottoman	24 W x 21 D x 18 H in	6-5008629-670	Specify	\$423.95	6-5008628-670	Specify	Specify	\$445.95
<b>F</b> Rectangle Ottoman	18 W x 18 D x 18 H in	6-5003944-670	Specify	\$421.95	6-5003985-670	Specify	Specify	\$443.95
<b>G</b> Round Ottoman	18 W x 18 D x 18 H in	6-5003942-670	Specify	\$433.95	6-5003980-670	Specify	Specify	\$455.95
<b>H</b> 1/2 Round Ottoman	18 W x 54 D x 18 H in	6-5003940-670	Specify	\$950.95	6-5003963-670	Specify	Specify	\$998.95
<b>I</b> Crescent Ottoman	18 W x 18 D x 18 H in	6-5003937-670	Specify	\$410.95	6-5003967-670	Specify	Specify	\$431.95
<b>J</b> Bench Ottoman	18 W x 48 D x 18 H in	6-5003939-670	Specify	\$851.95	6-5003986-670	Specify	Specify	\$894.95
<b>K</b> Arc Ottoman	18 W x 38 D x 18 H in	6-5003931-670	Specify	\$727.95	6-5003971-670	Specify	Specify	\$764.95
<b>L</b> 1/4 Round Ottoman	18 W x 27 D x 18 H in	6-5003932-670	Specify	\$585.95	6-5003978-670	Specify	Specify	\$615.95
<b>M</b> Pentagon Ottoman	26 W x 24 D x 18 H in	6-5003935-670	Specify	\$596.95	6-5003977-670	Specify	Specify	\$626.95
<b>N</b> Armless Sofa	67 W x 31 D x 35 H in	6-5003929-670	Specify	\$2,434.95	6-5003981-670	Specify	Specify	\$2,556.95
<b>O</b> Armless Loveseat	45 W x 31 D x 35 H in	6-5003948-670	Specify	\$1,480.95	6-5003982-670	Specify	Specify	\$1,554.95
<b>P</b> Armless Seat	21 W x 31 D x 35 H in	6-5003947-670	Specify	\$929.95	6-5003964-670	Specify	Specify	\$976.95
<b>Q</b> 60 Deg Inside Wedge Loveseat	46 W x 31 D x 35 H in	6-5003943-670	Specify	\$1,424.95	6-5003983-670	Specify	Specify	\$1,496.95
<b>R</b> Armless Sofa In	67 W x 31 D x 35 H in	6-5003946-670	Specify	\$1,624.95	6-5003979-670	Specify	Specify	\$1,706.95
<b>S</b> Armless Loveseat In	45 W x 31 D x 35 H in	6-5003950-670	Specify	\$1,180.95	6-5003969-670	Specify	Specify	\$1,239.95
<b>T</b> Armless Loveseat Out	45 W x 31 D x 35 H in	6-5003930-670	Specify	\$1,118.95	6-5003984-670	Specify	Specify	\$1,174.95
<b>U</b> 60 Deg Outside Wedge Loveseat	46 W x 31 D x 35 H in	6-5003933-670	Specify	\$1,338.95	6-5003966-670	Specify	Specify	\$1,405.95
<b>V</b> Armless Sofa Out	67 W x 31 D x 35 H in	6-5003928-670	Specify	\$1,543.95	6-5003970-670	Specify	Specify	\$1,621.95
<b>W</b> 30 Deg Wedge Bench	37 W x 27 D x 18 H in	6-5003949-670	Specify	\$1,046.95	6-5003973-670	Specify	Specify	\$1,099.95
<b>X</b> 60 Deg Wedge Bench	71 W x 27 D x 18 H in	6-5003938-670	Specify	\$1,564.95	6-5003976-670	Specify	Specify	\$1,643.95
<b>Y</b> Rocker Ottoman	18 W x 18 D x 20 H in	6-5004685-670	Specify	\$416.95	6-5004686-670	Specify	Specify	\$437.95
<b>Y</b> Rocker Ottoman	18 W x 18 D x 18 H in	6-5004683-670	Specify	\$398.95	6-5004684-670	Specify	Specify	\$418.95
<b>Y</b> Rocker Ottoman	18 W x 18 D x 15 H in	6-5004681-670	Specify	\$347.95	6-5004682-670	Specify	Specify	\$365.95
<b>Y</b> Rocker Ottoman	18 W x 18 D x 12 H in	6-5004679-670	Specify	\$323.95	6-5004680-670	Specify	Specify	\$340.95
<b>Z</b> Bow Tie Ottoman	21 W x 16 1/4 D x 18 H in	6-5004747-670	Specify	\$375.95	6-5004748-670	Specify	Specify	\$394.95
<b>NeoLounge® Sets</b>			<b>Color</b>			<b>Color 1</b>	<b>Color 2</b>	
<b>1</b> Honeycomb 7 Piece Set	60 W x 62 1/2 D x 18 H in	6-5003945-670	Specify	\$2,596.95	6-5003974-670	Specify	Specify	\$2,726.95
<b>2</b> Twist 5 Piece Set	48 W x 48 D x 18 H in	6-5003941-670	Specify	\$2,072.95	6-5003968-670	Specify	Specify	\$2,176.95
<b>3</b> Spinner 6 Piece Set	53 1/2 W x 56 1/4 D x 18 H in	6-5003951-670	Specify	\$2,860.95	6-5003975-670	Specify	Specify	\$3,003.95
<b>4</b> Sunflower 7 Piece Set	53 1/2 W x 59 1/4 D x 18 H in	6-5003934-670	Specify	\$3,050.95	6-5003965-670	Specify	Specify	\$3,203.95
<b>5</b> Wedge 6 Piece Set	48 W x 41 1/2 D x 18 H in	6-5003936-670	Specify	\$2,270.95	6-5003972-670	Specify	Specify	\$2,384.95
<b>6</b> Bow Tie Ottoman 6 Piece Set	60 1/2 W x 60 1/2 D x 18 H in	6-5004345-670	Specify	\$3,180.95	6-5004346-670	Specify	Specify	\$3,339.95

PLEASE SPECIFY COLOR CHOICE  
Refer to pages 60-61 for color options.



CLASSROOM SELECT

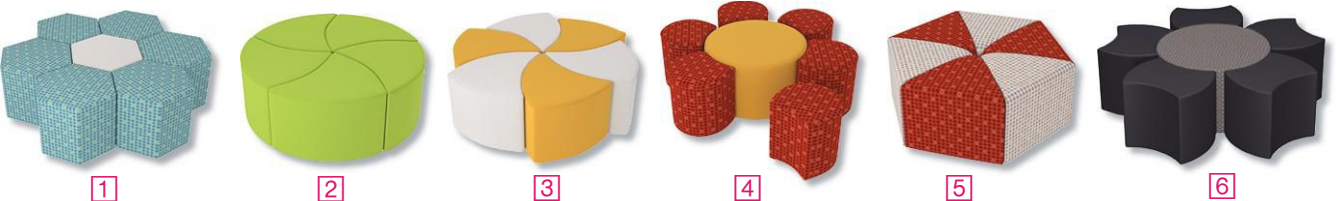
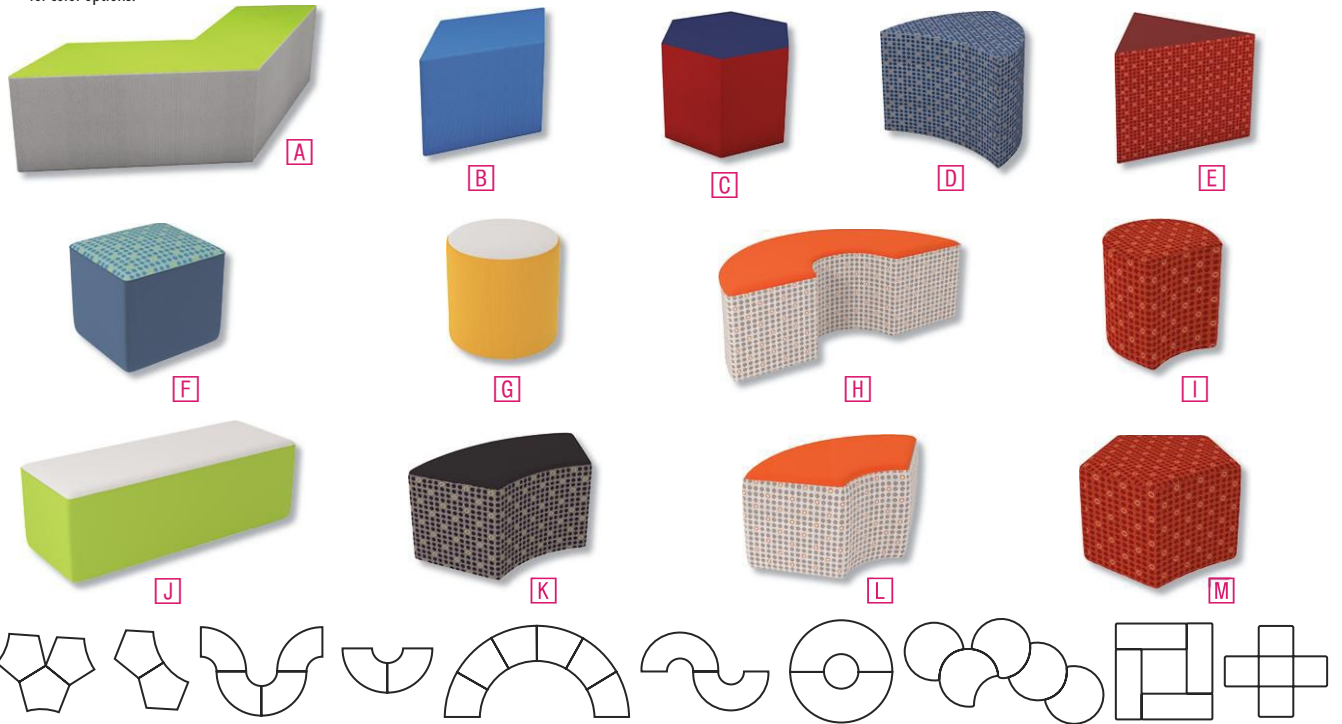



# CLASSROOM SELECT



PLEASE SPECIFY COLOR CHOICE

Refer to pages 60-61 for color options.

### Laminate Colors



## Classroom Select® REX™ Mobile Storage Stool

Stool was designed with flexible learning in mind. Stool and tablet are constructed of double-sided high-pressure laminate with ¾" particleboard core and finished with 2mm edge band. Features four 50mm locking casters. Seat height is 18 inches. Choose from a selection of top(laminate),edge and fabric(seat) colors to customize your space.

Item #	Description	Product Dimensions	Top Color	Edge Color	Fabric Color	List Price
6-5008614-670	Mobile Stool	16 W x 20-½ D x 18 H in	Specify	Specify	Specify	\$447.95
6-5008616-670	Mobile Stool w/Tablet Arm	16 W x 20-½ D x 29 H in	Specify	Specify	Specify	\$612.95



Floor Pads sold separately

## Classroom Select® Mobile Floor Pad Cart

Keep the NeoLounge2® Floor Pads neat and organized. The single cart stores up to ten 3" round and square Floor Pads and up to five 6" Deluxe Floor Pads. The double cart stores twenty 3" round and square Floor Pads and up to ten 6" Deluxe Floor Pads. Includes 4 heavy-duty casters, 2 locking. Platinum powdercoat finish.

Item #	Description	Product Dimensions	List Price
5-2090248-670	Single Floor Pad Cart	19 W x 19 D x 35 H in	\$242.95
5-2090249-670	Double Floor Pad Cart	37-½ W x 19 D x 35 H in	\$406.95



Round Seat Pad sold separately

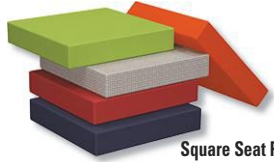

Square Seat Pad sold separately



Round Deluxe Seat Pad



Floor Pad



Rectangle Short Seat Pad



Rectangle Long Seat Pad

## Classroom Select® NeoLounge2® Floor Pad

Create a comfy, flexible learning space for students to work on their own or in a group. Fun yet functional, the NeoLounge2® floor pads are lightweight and constructed with high-quality foam and durable material. Features a concealed zipper to remove cover for washing. Only the large Floor Pad comes with an anti-skid bottom and handle. Choose from our extensive line of fabric colors and prints to make your space unique! **Quickship available in Vinyl fabrics: Canter-Ink, Canter-Adobe, Canter-Red and in Coated fabrics: Eon-Atlantic, Eon-Spring, Eon-Typographic.**

Description	Product Dimensions	One Color		
		Item #	Color	List Price
Round Seat Pad	16 W x 16 D x 3 H in	6-5004359-670	Specify	\$126.95
Square Seat Pad	16 W X 16 D X 3 H in	6-5004360-670	Specify	\$126.95
Round Deluxe Seat Pad	16 W x 16 D x 6 H in	6-5004739-670	Specify	\$160.95
Rectangle Short Seat Pad	24 W x 14 D x 6 H in	6-5004741-670	Specify	\$202.95
Rectangle Long Seat Pad	48 W x 14 D x 6 H in	6-5004740-670	Specify	\$257.95
Floor Pad	42 W x 32 D x 3 H in	6-5004742-670	Specify	\$318.95



Lounge Chair

Ottoman



Rocker



Chaise Lounger

## Classroom Select® NeoLounge2® Soft Seating

Add stylish, comfortable seating to common areas, library, or lounge spaces with NeoLounge2® soft seating. Made with high-quality foam and durable, long-lasting material with a locking zipper. The Rocker is constructed with a sturdy wood frame to create rocking motion. Choose from our extensive line of colors and fabrics. Mix and match to create an inviting space for your students!

Description	Product Dimensions	One Color			Two Color			
		Item #	Color	List Price	Item #	Color	Side/Back Color	List Price
Lounge Chair	22 W x 28-½ D x 32 H in	6-5004744-670	Specify	\$643.95	6-5004745-670	Specify	Specify	\$804.95
Ottoman	22 W x 17 D x 13-½ H in	6-5004312-670	Specify	\$306.95	6-5004313-670	Specify	Specify	\$383.95
Rocker	21 W x 26-½ D x 25-½ H in	6-5004311-670	Specify	\$769.95	6-5004310-670	Specify	Specify	\$962.95
Chaise Lounger	22 W x 54 D x 34 H in	6-5004363-670	Specify	\$934.95	6-5004743-670	Specify	Specify	\$1,168.95

# CLASSROOM SELECT

## Microsuede Colors



Foam Lounger



Foam Round



Foam Pillow



## Classroom Select® NeoLounge2® Foam Bean Bag

Microsuede foam-filled bean bags are a flexible seating option for studying, reading or lounging. Covered in soft microsuede material and filled with high-quality foam for ultimate comfort. Features inner liner and two locking zippers for safety. Microsuede can be spot cleaned with a water based cleaning solution or remove cover for machine washability. Meets TB 117 standards.

Item #	Description	Color	Product Dimensions	List Price	Item #	Description	Color	Product Dimensions	List Price
6-5008608-670	Small Lounger	Specify	25 W x 34 D x 19 H in	\$186.95	6-5004316-670	Medium Round Bag	Specify	45 W x 45 D x 16 H in	\$315.95
6-5004315-670	Medium Lounger	Specify	46 W x 34 D x 26 H in	\$337.95	6-5008607-670	Large Round Bag	Specify	72 W x 72 D x 22 H in	\$405.95
6-5008610-670	Large Lounger	Specify	50 W x 68 D x 38-1/2 H in	\$432.95	6-5004746-670	Small Pillow	Specify	44 W x 64 D x 15 H in	\$348.95
6-5008611-670	Small Round Bag	Specify	36 W x 36 D x 11 H in	\$159.95	6-5008609-670	Medium Pillow	Specify	53 W x 77 D x 20 H in	\$428.95

## Indoor/Outdoor Colors

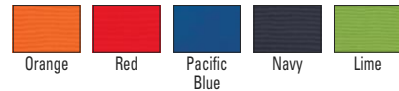

Square Ottoman



Round Ottoman



Bench Ottoman



Dew Drop Bean Bag Chair



Bean Bag Chair

## Classroom Select® NeoLounge2® Indoor/Outdoor Seating

Take the classroom or studying outside with comfy bean-filled chairs and ottomans! Cover made with machine washable, soft canvas fabric that's water, mildew, stain and fade resistant. Constructed using UV stable thread. Features an inner liner with locking zipper to keep the styrofoam beads inside! Lightweight and easy to move around. To increase longevity, it's recommended to store in a covered space while not in use.

Item #	Description	Color	Product Dimensions	List Price	Item #	Description	Color	Product Dimensions	List Price
6-5008631-670	Junior Round Ottoman	Specify	14 W x 14 D x 12 H in	\$106.95	6-5004357-670	Round Ottoman	Specify	21 D x 17 H in	\$146.95
6-5008625-670	Junior Square Ottoman	Specify	14 W x 14 D x 12 H in	\$118.95	6-5004358-670	Square Ottoman	Specify	17 W x 17 D x 17 H in	\$158.95
6-5008630-670	Junior Dew Drop Chair	Specify	24 W x 18 D x 20 H in	\$238.95	6-5004370-670	Dew Drop Chair	Specify	36 W x 28 D x 30 H in	\$278.95
6-5008627-670	Junior Bean Bag Chair	Specify	21 W x 17 D x 17 H in	\$265.95	6-5004371-670	Bean Bag Chair	Specify	36 W x 26 D x 28 H in	\$305.95
					6-5004368-670	Bench Ottoman	Specify	26 W x 18 D x 14 H in	\$215.95

**CLASSROOM  
SELECT**

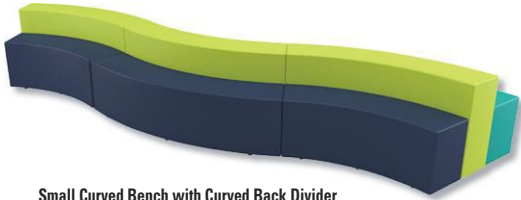

Small Curved Bench with Curved Back Divider and Large Curved Bench



Large Curved Bench



Round Ottoman



Curved Back Divider



Small Curved Bench



Straight Back Divider

**Out2Learn™ Outdoor Seating Colors**

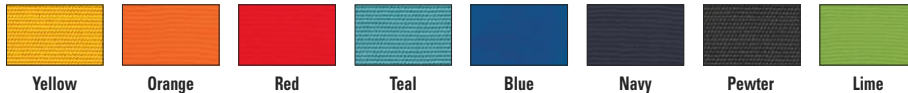

**Classroom Select® Out2Learn™ Outdoor Seating**

Take the classroom outdoor with the Classroom Select® Out2Learn™ Outdoor Seating with fully outdoor safe seating. Cover made of soft canvas fabric that's water, mildew, stain, and fade resistant. Foam interior is uniquely designed to withstand outdoor elements. Constructed using UV stable thread. Durable handles and the lightweight weight construction make moving around a breeze. Benches can be used alone or with the Back Divider, and connected with gaining straps that come standard on every unit.

Item #	Description	Color	Product Dimensions	List Price
6-5009511-670	Outdoor Small Curved Bench	Specify	53 W x 14 D x 18-1/2 H in	\$763.95
6-5009504-670	Outdoor Large Curved Bench	Specify	73 W x 14 D x 18-1/2 H in	\$1,144.95
6-5009510-670	Outdoor Curved Back Divider	Specify	63 W x 12 D x 27-1/2 H in	\$1,311.95
6-5009514-670	Outdoor Straight Bench	Specify	53 W x 19 D x 18-1/2 H in	\$1,076.95
6-5009516-670	Outdoor Straight Back Divider	Specify	43 W x 12 D x 27-1/2 H in	\$988.95
6-5009521-670	Outdoor Round Ottoman	Specify	18 W x 18 D x 15 H in	\$386.95

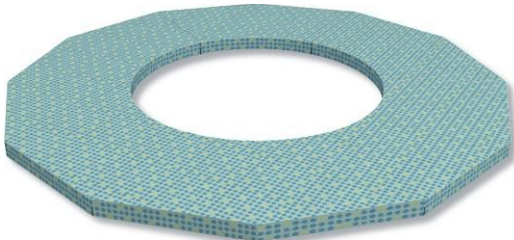

Circle Floor Fort Set of 6 - Shown flat for collaborative floor seating in single color



Polygon Floor Fort Set of 6 - Shown flat for collaborative floor seating in single color



Circle Floor Fort Set of 6 - Shown with 3 pads flat for floor seating, and 3 pads Velcroed together for a fort in dual color



Polygon Floor Fort Set of 6 - Shown 3 pads Velcroed together makes 2 separate fort in dual color



Refer to pages 60-61 for color options.

**Classroom Select® NeoLounge2® Floor Forts**

Classroom Select® NeoLounge2® Floor Forts create a comfy, flexible learning space for students to work, in a group or on their own. Fun yet functional, the NeoLounge2® Floor Forts are lightweight and constructed with high-quality foam and durable material. Sold as a 6-piece set, allowing students to build a quiet space or use as individual floor cushions. Connect floor fort pads to make fun fort learning spaces or attach as one large floor pad for collaborative learning, with strong Velcro edges. Velcro edges can be covered up when not in use.

Item #	Description	Color	Product Dimensions	List Price
6-5009509-670	Circle Floor Fort-Single Color	Specify	96 W x 92 D x 3 H in	\$3,199.95
6-5009513-670	Circle Floor Fort-Dual Color	Specify	96 W x 92 D x 3 H in	\$3,359.95
6-5009507-670	Polygon Floor Pad-Single Color	Specify	72 W x 67 D x 3 H in	\$2,012.95
6-5009518-670	Polygon Floor Pad-Dual Color	Specify	72 W x 67 D x 3 H in	\$2,113.95





# CLASSROOM SELECT® SOFT SEATING COMPARISON CHART

Use this chart to compare our top-selling soft seating to find the right product for your needs.



	NEOFUSE® P.166	NEOSIT® P.167	NEOLINK® P.168-170	NEOLOUNGE® P.171-172	NEOLOUNGE2® ROCKER, CHAISE AND LOUNGER P.173	NEOLOUNGE2® FLOOR PADS P.173	NEOLOUNGE2® FOAM BAG P.174	NEOLOUNGE2® INDOOR/OUTDOOR BEANBAGS P.174	OUT2LEARN™ P.175	
Collection Description	Pieces easily "fuse" together to create ideal work zones. Use each piece as a building block to make comfortable, durable, easily moveable configurations for everything from a small section in a classroom to a full atrium	Like nothing in the market, the unique finish on this product makes it extremely durable. It's easy to clean and easy to move. Custom colors and shapes available. Use outside without worry of product fading	This collection was designed to be linked together to create a perfect space. Pieces come standard with a ganging device to achieve endless options- chairs, sofas, high backs, low backs, with or without arms and power in multiple locations. Compatible storage and table options are also included	Create a comfortable lounge space with these solid foam construction ottomans that can be configured in fun shapes for collaborative learning. This collection features our highest Foam ILD (Indentation Load Deflection), making it extremely durable	Add stylish, comfortable seating to common areas, libraries, or lounge spaces with Neolounge2® soft seating. Made with high-quality foam and durable, long-lasting materials	Just like the Neolounge® collection lounging is made easy with the all foam construction. Pieces are lightweight and easy to move			Take the indoors out with our Classroom Select® Out2Learn™ outdoor safe soft seating	
Fabric	Standard Grade 2 Fabric - custom fabrics also available		Standard Grade 2 offering - custom fabrics also available	Standard Grade 2 offering - custom fabrics also available	Standard Grade 2 offering - custom fabrics also available	Removable cover for easy washing	Removable washable micro-suede cover	Removable UV stable washable canvas cover	UV stable canvas cover	
Foam Interior	55 ILD foam density	Medium density polyurethane foam	55 ILD foam density	70 ILD foam density	70 ILD foam density	70 ILD foam density	Polyurethane foam filling material	Polystyrene filling material	Foam interior is uniquely designed to withstand outdoor elements	
Construction	Seat suspension webbing is interior webbing that provides support for the seat	All foam construction with a two step silicone-based coating process	Hardwood frame seat suspension webbing ensures durability, comfort and longevity	Foam construction, base made of MDF	Hardwood frame with foam - Rocker has a wood frame to create a smooth rocking motion	All foam construction with concealed zipper	Foam pieces with locking zipper	Styrofoam beads with inner linear & locking zipper	Weather-treated plywood frame with weather-safe foam	
Legs/Glides/ Base	Non-marring Glides		18-gauge U-shape steel legs with nylon glides	Selected items have aluminum extruded legs with nylon glides	Rocker has a plastic over-molded Base				Outdoor safe glides and steel stabilizing bars come standard on all dividers	
Compliance	Interior Wood Carb CII Complaint Cal 117-2013 Standard		Interior Wood Carb CII compliant Cal 117-2013 Standard	Interior Wood Carb CII Complaint, Cal 117-2013 Standard	Interior Wood Carb CII compliant Cal 117-2013 Standard	Cal 117-2013 Standard	Cal 117-2013 Standard			

CLASSROOM  
SELECT 

Available With Power!

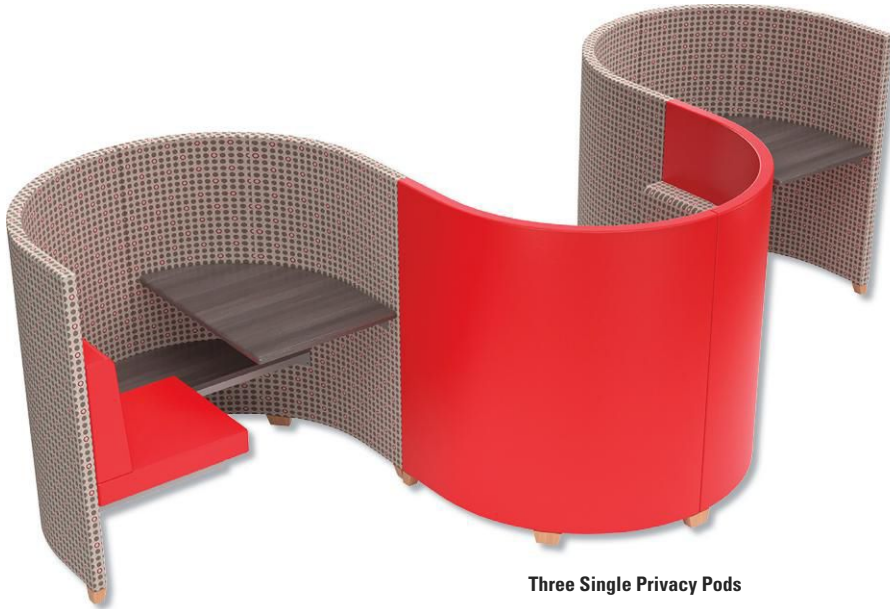

Three Single Privacy Pods

Wall color and seat color can be specified from the "Soft Seating Fabrics" on page 61.

Classroom Select®  
Laminate Top Colors



Single Privacy Pod, Left Side

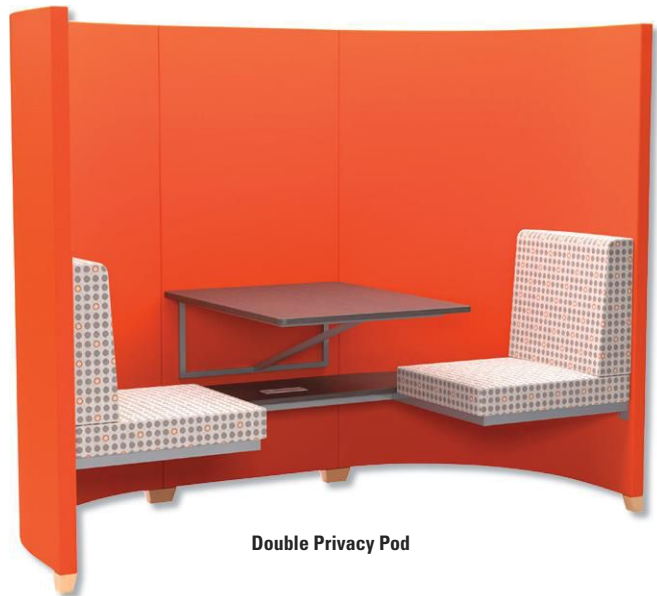

Double Privacy Pod

Classroom Select® Privacy Pod

Classroom Select® Privacy Pods are the perfect solution for working or studying in comfort. Choose from a vibrant, easy to clean fabric palette with coordinating prints adding a welcoming aesthetic and contemporary style. Match these pods back to Classroom Select® Soft Seating to complete your common area or media center. The built in worksurface and side table is available in left or right-hand orientation and with or without power. Choose from a tall or short wall in either single or double pods for independent or collaborative learning. Available in eight laminate top color options. Edge color matches the top color.

Item #	Description	Product Dimensions	Frame Color	Seat Color	Top Color	List Price
<b>Privacy Pods Without Power</b>						
6-5003777-670	Short Single, Right Side	52-1/2 W x 38-1/4 D x 48 H in	Specify	Specify	Specify	\$4,640.95
6-5003734-670	Short Single, Left Side	52-1/2 W x 38-1/4 D x 48 H in	Specify	Specify	Specify	\$4,640.95
6-5003774-670	Tall Single, Right Side	52-1/2 W x 38-1/4 D x 62 H in	Specify	Specify	Specify	\$4,829.95
6-5003731-670	Tall Single, Left Side	52-1/2 W x 38-1/4 D x 62 H in	Specify	Specify	Specify	\$4,829.95
6-5003776-670	Short Double Pod	78-3/4 W x 35-1/2 D x 48 H in	Specify	Specify	Specify	\$6,640.95
6-5003773-670	Tall Double Pod	78-3/4 W x 35-1/2 D x 62 H in	Specify	Specify	Specify	\$7,004.95
<b>Privacy Pods With Power</b>						
6-5003779-670	Short Single, Right Side	52-1/2 W x 38-1/4 D x 48 H in	Specify	Specify	Specify	\$5,021.95
6-5003733-670	Short Single, Left Side	52-1/2 W x 38-1/4 D x 48 H in	Specify	Specify	Specify	\$5,021.95
6-5003772-670	Tall Single, Right Side	52-1/2 W x 38-1/4 D x 62 H in	Specify	Specify	Specify	\$5,200.95
6-5003732-670	Tall Single, Left Side	52-1/2 W x 38-1/4 D x 62 H in	Specify	Specify	Specify	\$5,200.95
6-5003775-670	Short Double Pod	78-3/4 W x 35-1/2 D x 48 H in	Specify	Specify	Specify	\$7,182.95
6-5003778-670	Tall Double Pod	78-3/4 W x 35-1/2 D x 62 H in	Specify	Specify	Specify	\$7,436.95



NeoDen®  
Open Wall with Table



NeoDen®  
Full Wall with Table

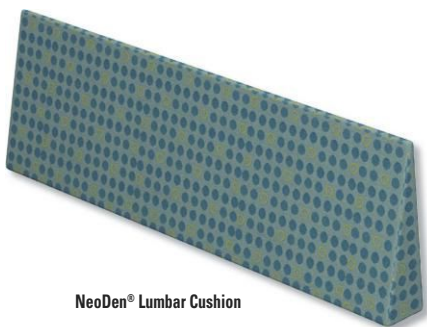

NeoDen® Lumbar Cushion



NeoDen® Markerboard  
Wall with Table

CLASSROOM  
SELECT 



PLEASE  
SPECIFY  
COLOR  
CHOICE

Refer to pages 60-61  
for color options.

### Classroom Select® NeoDen®

Add a NeoDen® to atriums, media centers, lounge areas, classrooms, cafeterias, and even hallways. The exterior is made of durable high pressure laminate, and the interior is lined with any one of our 34 fabric options. The seats, seat backs and ceiling is lined with 3" foam for added comfort. The upholstered foam interior offers a cozy sound barrier and the open side/sides make students still feel like part of the environment. Included with each NeoDen® is USB plugs, overhead lighting, and power. Available storage space located under seating benches. Super heavy duty 4-inch casters provide smooth and reliable transportation. Our NeoDen® comfortably sits 4 people, with an optional open back, a standard back or a markerboard back wall. Choose between our pre-assembled version, which is ready to use or our unassembled version. All doorways should be measured to ensure proper fit of pre-assembled NeoDen® units.

Item #	Product Dimensions	Top Color	Fabric Color	List Price
<b>NeoDen® Open Wall - Unassembled</b>				
6-5004207-670	79 W x 36 D x 77 H in	Specify	Specify	\$18,071.95
<b>NeoDen® Open Wall - Assembled</b>				
6-5004212-670	79 W x 36 D x 77 H in	Specify	Specify	\$18,688.95
<b>NeoDen® Full Wall - Unassembled</b>				
6-5004208-670	79 W x 36 D x 77 H in	Specify	Specify	\$19,157.95
<b>NeoDen® Full Wall - Assembled</b>				
6-5004213-670	79 W x 36 D x 77 H in	Specify	Specify	\$19,666.95
<b>NeoDen® Markerboard Wall - Unassembled</b>				
6-5004209-670	79 W x 36 D x 77 H in	Specify	Specify	\$19,262.95
<b>NeoDen® Markerboard Wall - Assembled</b>				
6-5004214-670	79 W x 36 D x 77 H in	Specify	Specify	\$19,765.95
<b>NeoDen® Lumbar Cushion</b>				
6-5004211-670	36 W x 6 D x 10 H in	-	Specify	\$247.95



NeoDen®  
Back View





**CLASSROOM SELECT**

PLEASE SPECIFY COLOR CHOICE

Refer to pages 60-61 for color options.

**Classroom Select® Geode Series® Den**

The Classroom Select® Geode Series® Den is made with a durable 18-gauge steel frame and side panels, which are available in 11 vibrant color options to coordinate in your classroom. Super heavy duty 4-inch casters provide smooth and reliable transportation. The inside side panels are lined with an easy to clean gray vinyl fabric with 1/2" of foam for added comfort. You can customize the interior by choosing all one fabric color for the seat, back and ceiling or two fabric color options by picking one color for the seat and another color for the back and ceiling panels. Geode 3" Totes trays are compatible with this unit in. Side panels features rows of peg board perforations for increased storage potential. All units ship fully assembled and are crafted in the USA with globally sourced materials

Item #	Description	Product Dimensions	Seat Color	Fabric Color	List Price
6-5004219-670	Mini Geode Den	19-1/4 L x 41 W x 59-1/2 H in	Specify	-	\$3423.95
6-5004766-670	Mini Geode Den Dual Fabric	19-1/4 L x 41 W x 59-1/2 H in	Specify	Specify	\$3923.95

**Smith Carrel Colors**

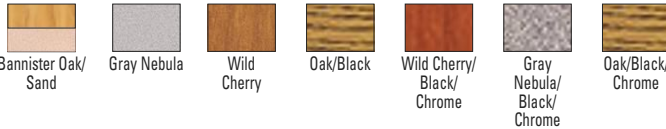

SMITH CARREL, INC.

**Smith Carrel Inc Pedestal Base Carrel**

Work surface adjusts in height from 22" to 30", with 3/4" solid core melamine panels. Work surface includes wiring grommet. Full 14-gauge rail system and upper leg sockets. 1 1/4" sq. x 16-gauge stabilizer bar. Finished with baked on epoxy powder. Chrome adjustable legs are 1" x 2" x 16-gauge tubing with 1" leveling glides. Overall dimensions: 37"W x 24"D x 47"H in highest position. Ships ready to assemble.



Item #	Description	Product Dimensions	Color	List Price
6-1364307-670	Study Carrel, Adj. Height	37 W x 24 D x 39-47 H in	Specify	\$764.95



PRODUCT CERTIFIED FOR LOW CHEMICAL EMISSIONS: UL.COM/IGG UL 2818



ASSEMBLED IN U.S.A. WITH GLOBAL MATERIALS

**CHILDCRAFT**  
A School Specialty Exclusive

**Childcraft® Student Reading Carrel**

Semi-private carrel is available in a range of leg/top heights. Simple leg assembly required.



Item #	Description	Product Dimensions	Top Height	List Price
5-1357857-670	Student Carrell	25-3/4 Wx19-3/4 Dx31-3/4 H in	18-3/4 in	\$587.95
5-1357858-670	Student Carrell	25-3/4 W x 19-3/4 D x 33 H in	20 in	\$587.95
5-1357859-670	Student Carrell	25-3/4 W x 19-3/4 D x 35 H in	22 in	\$587.95
5-1357860-670	Student Carrell	25-3/4 W x 19-3/4 D x 37 H in	24 in	\$587.95
5-1357845-670	Student Carrell	25-3/4 W x 19-3/4 D x 39 H in	26 in	\$587.95
5-1473449-670	Student Carrell	25-3/4 W x 19-3/4 D x 41 H in	28 in	\$587.95
5-1473479-670	Student Carrell	25-3/4 W x 19-3/4 D x 43 H in	30 in	\$587.95

**Porta-Screen Carrel**

An economical, lightweight, 3-panel study carrel which can be moved from desk to desk when privacy is required. The carrel is made of polyethylene and measures 42" x 11-3/4" with two 10-1/2" x 11-3/4" side panels to create a desk space of 21" x 10-1/2". Comes in assorted colors: red, yellow, orange, and blue (sorry, no color choice).

Item #	Description	Color	Dimensions	List Price
9-626436-670	Porta-Screen Carrel	Assorted	11-3/4 x 21 in	\$15.99

**QUICKSHIP** 24 HRS 48 HRS 1 OR 2 WEEKS  
Items ship within 24 hrs, 48 hrs, 1 or 2 weeks as indicated when the factory distribution center receives the order.

Items ship **Freight** or **Parcel** See Shipping & Handling terms for details.

**R•WIREworks, Inc.**

**R•WIREworks Book Spinners**

The SILENT Partner™ noiseless operation creates a relaxed atmosphere for leisurely browsing. The face-out display will show off hundreds of paperbacks for increased circulation.



**PAPERFLOW**

**Mobile Literature Displays**

Mobile display unit with five shelves. Made of durable plastic with metal reinforcement and plastic shelves. Four casters. Easy to assemble with no tools required.



Item #	Description	Product Dimensions	Number of Pockets	List Price
9-644749-670	Rotating Paperback Display	20 W x 20 D x 64 H in	56	\$625.95

Item #	Description	Product Dimensions	Color	Number of Tiers	List Price
6-2006445-670	Mobile Literature Display	13-3/4 W x 15-1/4 D x 66 H in	Silver	5	\$698.95



**Deflect-o® Contemporary Floor Stand**

Contemporary floor stand offers six large-capacity compartments for magazine-size materials. Each compartment holds up to 1 1/2" D. Ideal for reception areas, waiting rooms and classrooms. Open design features sleek curves, metal frame and plastic pockets.

**⚠ WARNING: This product can expose you to chemicals including Chromium, which is known to the State of California to cause birth defects or other reproductive harm. For more information go to www.P65Warnings.ca.gov.**



Item #	Description	Color	List Price
6-1383199-670	Literature Floor Stand	Silver	\$605.95
6-1378539-670	Literature Floor Stand	Black	\$605.95

**SAFCO®**

**Safco® 48 Pocket Rotating Literature Display**

48 Pocket Solid Wood Rotating Display Racks rotate 360 degrees for easy access to all materials. Scoop design allows maximum visibility and easy retrieval. Available in Medium Oak or Mahogany. Pocket Size is 9 1/2"W x 3/4"D x 11"H.

**⚠ WARNING: This product can expose you to chemicals including Di-n-butyl phthalate (DBP), which is known to the State of California to cause birth defects or other reproductive harm. For more information go to www.P65Warnings.ca.gov.**

**Safco Literature Colors**



Item #	Description	Product Dimensions	Color	List Price
6-1364948-670	48 Pocket Rotating Display	17-3/4 Wx17-3/4 Dx49-1/2 H in	Specify	\$1,770.95



### Monaco Original HangUp® Bags

Sturdy, portable storage bags for media materials, crafts, sewing & knitting accessories, books, charts and so much more. Robust 4-mil clear polyethylene plastic stands up to the rigors of classroom use. White plastic handle hook with snap-shut closure. Bags are reusable and can be sanitized. Set of 10.

Item #	Product Dimensions	List Price
9-658929-670	9 W x 8 H in	\$15.95
9-658930-670	8-1/2 W x 10 H in	\$16.95
9-650362-670	10 W x 13-1/2 H in	\$17.95
9-658931-670	13-1/2 W x 13-1/2 H in	\$18.95
9-200356-670	12-1/2 W x 14-1/2 H in	\$18.95
9-658932-670	14 W x 21 H in	\$23.95
9-658933-670	16 W x 25 H in	\$27.95
9-650365-670	20 W x 25 H in	\$27.95
9-256905-670	22 W x 28 H in	\$30.95



HangUp® Bags



### Monaco Sturdy Tabletop Rack

Self-supporting rack of anodized aluminum for use on any flat surface. Provides efficient, economical storage and display for a wide variety of media materials. Supports up to 25 lbs.. Rubber feet protect surfaces from scratches.

Item #	Description	Product Dimensions	List Price
9-658934-670	Tabletop Rack	30 W x 8 D x 17 H in	\$107.95

### Monaco Revolving Floor Stand

Sturdy chrome floor stand provides display and storage for hundreds of HangUp® Bags. These racks are available in single and multi tier styles. The 2-Tier Stand is perfect for Big Book Bags.



Item #	Description	Product Dimensions	List Price
5-650350-670	1-Tier Stand for Hangup Bags	20 Dia x 40 H in	\$399.95
5-650353-670	2-Tier Stand for Hangup Bags	20 Dia x 40 H in	\$618.95
5-658928-670	2-Tier Stand for Hangup Bags	20 Dia x 68 H in	\$677.95
5-650359-670	3-Tier Stand for Hangup Bags	20 Dia x 60 H in	\$824.95



6 Magazine, 12 Pamphlet



9 Magazine



PRODUCT CERTIFIED FOR LOW CHEMICAL EMISSIONS: UL COM/IGG UL 2818

## SAFCO®

### Safco® Reveal Magazine and Pamphlet Displays

Think outside of the box by looking in! Reveal design displays literature clearly. Each pocket holds 1 3/4" of printed material. Thermoformed, one-piece units have no sharp edges or corners. The displays are wall mountable with hardware included. Optional floor stand or wire hanger for partitions available.

Item #	Description	Product Dimensions	List Price
6-1111191-670	6 Pocket Magazine	30 W x 2 D x 24-1/2 H in	\$472.95
6-1111187-670	9 Pocket Magazine	30 W x 2 D x 36-3/4 H in	\$578.95
6-1286029-670	12 Pocket Magazine	30 W x 2 D x 49 H in	\$647.95
6-1279870-670	3 Magazine, 6 Pamphlet	30 W x 2 D x 22-1/2 H in	\$436.95
6-1134825-670	6 Magazine, 6 Pamphlets	30 W x 2 D x 34-3/4 H in	\$574.95
6-1313264-670	6 Magazine, 12 Pamphlet	30 W x 2 D x 45 H in	\$618.95

## SAFCO®

### Safco Onyx Rotating Mesh Magazine Stand

Stand is ideal for reception areas or waiting rooms. This contemporary, three-sided rack rotates 360° for total access to all literature. Floor standing units feature thirty 1" capacity pockets. Black steel mesh construction with powder coat finish for durability. Greenguard Certified. Limited Lifetime Warranty. Assembly required.



Item #	Description	Product Dimensions	Color	List Price
6-1313263-670	Rotating Mesh Magazine Stand	16-1/2 W x 16-1/2 D x 66 H in	Black	\$766.95



QUICKSHIP  
Items ship within 24 hrs, 48 hrs, 1 or 2 weeks as indicated when the factory distribution center receives the order.

Items ship **Freight** or **Parcel**

See Shipping & Handling terms for details.



**SAFCO**

**Safco® Runtz™ and Zenergy™ Chairs**

Safco® Zenergy™ and Runtz™ products are designed to promote active movement throughout the day and engage major muscle groups to help combat the negative effects of inactivity. These active products are designed to be an alternative desk chair or for use in meeting areas, gathering spaces, waiting rooms, or classrooms. All products include a 17-½ inch (anti-burst) exercise ball and a pump. The ball chairs include removable legs, so the feet can be inserted in the base for another size option. The swivel ball chair does not include legs, but features a 360° swivel base with active user control movement.



Runtz Swivel Ball Chair



Zenergy Ball Chair

Item #	Description	Color	Product Dimensions	List Price
5-5009500-670	Runtz Ball Chair	Specify	22-½ W x 22-½ D x 17 H in	\$301.95
5-5009501-670	Runtz Swivel Ball Chair	Specify	17 W x 17 D x 16-¾ H in	\$365.95
5-5009502-670	Zenergy Ball Chair	Specify	22-½ W x 22-½ D x 23 H in	\$322.95
5-5009503-670	Zenergy Swivel Ball Chair	Specify	17-½ W x 17-½ D x 23 H in	\$382.95



Zenergy Swivel Ball Chair



Runtz Ball Chair



**SAFCO**

**Twixt® Active Seating Chair**

Safco presents the Twixt® Ergonomic Stool designed to help support better posture and balance. Flexible ring under base allows user to adjust angle of sit and provides movement for an active sitting experience. The Twixt™ Ergonomic chair features an upholstered seat, is height-adjustable and offers a 360° swivel. Choose from black vinyl or a variety of colors, along with extended heights. **⚠️WARNING: This product can expose you to chemicals including Lead, which is known to the State of California to cause cancer. For more information go to www.P65Warnings.ca.gov.**

Item #	Description	Product Dimensions	Seat Color	List Price
5-1556814-670	Twixt Desk Height	15-½ W x 15-½ D x 17-22 H in	Specify	\$344.95
5-1556819-670	Twixt Desk Height	15-½ W x 15-½ D x 17-22 H in	Black	\$344.95
5-1556815-670	Twixt Extended Height	15-½ W x 15-½ D x 31-¾ H in	Specify	\$378.95
5-1556820-670	Twixt Extended Height	15-½ W x 15-½ D x 31-¾ H in	Black Vinyl	\$378.95



**Twixt Seating Color**



Metal w/Back



Metal w/Back and Arms



Plastic w/Back



Plastic - No Back

**CanDo® Ball Chair**

- Chairs come with backs, arms, or without and plastic bases to hold therapy balls
- Chairs are offered in child or adult sizes measured at 23" x 20" x 15", 22" x 26" x 32", 22" x 24" x 26"
- Replacement balls come in child size 15" or adult size 22"
- Balls have a non-slip PVC vinyl surface and is ribbed for extra security

Item #	Description	Product Dimensions	Color	Quantity	List Price
5-5000737-670	Metal w/ Back	22 W x 26 D x 32 H in	Specify	Each	\$166.95
5-5000736-670	Metal w/ Back and Arms	22 W x 26 D x 32 H in	Specify	Each	\$191.95
5-5000739-670	Plastic w/ Back - Child Size	23 W x 20 D x 15 H in	Specify	Each	\$132.95
5-5000738-670	Plastic w/ Back - Adult Size	22 W x 26 D x 32 H in	Specify	Each	\$140.95
5-5000735-670	Plastic - No Back	22 W x 24 D x 26 H in	Specify	Each	\$123.95
5-1588136-670	Casters		Black	Set of 2	\$18.95
5-1425490-670	Replacement Ball - 15 inches	-	Blue	Each	\$21.95
5-1412625-670	Replacement Ball - 22 inches		Black	Each	\$21.95

**CLASSROOM  
SELECT** 



PLEASE SPECIFY  
COLOR CHOICE  
Refer to pages 60-61  
for color options.



Single Laminate



Two Laminate



Single Laminate w/ Power

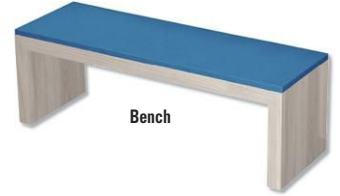

Bench

Markerboard options below  
only available for Community Tables



**Classroom Select® Community Table**

The Classroom Select® Community Table and Bench offer an open meeting concept. Designed for libraries, lounge areas and collaborative learning spaces, offered in a variety of sizes and height options. Centrally located inset power options are also available for all of your charging needs, complete with 2 USB and 2 outlets. Choose between a 2 laminate or one laminate table in any of our 31 laminate choices. Markerboard available in 5 colors on top and side, and 31 laminate under and inside colors. Community Side Bench has a 3" upholstered seat cushion for added comfort offered in any of our 34 fabric options.

**Table without Power**

Product Dimensions (D x W)	Product Height (29", 36", or 42")	Single Laminate Color Option			Two Laminate Color Option				Markerboard Option			
		Item #	Color	List Price	Item #	Top/Outside Color	Under/Inside Color	List Price	Item #	Top/Outside Color	Lam Under/Inside Color	List Price
30 x 60 in	Specify	6-5004103-670	Specify	\$2,655.95	6-5004119-670	Specify	Specify	\$2,910.95	6-5004409-670	Specify	Specify	\$2,772.95
30 x 72 in	Specify	6-5004104-670	Specify	\$2,893.95	6-5004120-670	Specify	Specify	\$3,171.95	6-5004410-670	Specify	Specify	\$3,020.95
30 x 84 in	Specify	6-5004105-670	Specify	\$3,026.95	6-5004121-670	Specify	Specify	\$3,317.95	6-5004411-670	Specify	Specify	\$3,159.95
30 x 96 in	Specify	6-5004106-670	Specify	\$3,055.95	6-5004122-670	Specify	Specify	\$3,348.95	6-5004412-670	Specify	Specify	\$3,189.95
36 x 60 in	Specify	6-5004107-670	Specify	\$2,426.95	6-5004397-670	Specify	Specify	\$2,660.95	6-5004413-670	Specify	Specify	\$2,533.95
36 x 72 in	Specify	6-5004108-670	Specify	\$2,657.95	6-5004398-670	Specify	Specify	\$2,912.95	6-5004414-670	Specify	Specify	\$2,773.95
36 x 84 in	Specify	6-5004109-670	Specify	\$3,040.95	6-5004399-670	Specify	Specify	\$3,333.95	6-5004415-670	Specify	Specify	\$3,174.95
36 x 96 in	Specify	6-5004110-670	Specify	\$3,069.95	6-5004400-670	Specify	Specify	\$3,364.95	6-5004416-670	Specify	Specify	\$2,937.95
42 x 60 in	Specify	6-5004111-670	Specify	\$2,813.95	6-5004401-670	Specify	Specify	\$3,084.95	6-5004417-670	Specify	Specify	\$2,945.95
42 x 72 in	Specify	6-5004112-670	Specify	\$2,820.95	6-5004402-670	Specify	Specify	\$3,091.95	6-5004418-670	Specify	Specify	\$2,981.95
42 x 84 in	Specify	6-5004113-670	Specify	\$2,856.95	6-5004403-670	Specify	Specify	\$3,130.95	6-5004419-670	Specify	Specify	\$3,007.95
42 x 96 in	Specify	6-5004114-670	Specify	\$3,142.95	6-5004404-670	Specify	Specify	\$3,444.95	6-5004420-670	Specify	Specify	\$3,280.95
48 x 60 in	Specify	6-5004115-670	Specify	\$2,881.95	6-5004405-670	Specify	Specify	\$3,158.95	6-5004421-670	Specify	Specify	\$3,099.95
48 x 72 in	Specify	6-5004116-670	Specify	\$2,902.95	6-5004406-670	Specify	Specify	\$3,181.95	6-5004422-670	Specify	Specify	\$3,029.95
48 x 84 in	Specify	6-5004117-670	Specify	\$2,923.95	6-5004407-670	Specify	Specify	\$3,205.95	6-5004423-670	Specify	Specify	\$3,053.95
48 x 96 in	Specify	6-5004118-670	Specify	\$2,938.95	6-5004408-670	Specify	Specify	\$3,220.95	6-5004424-670	Specify	Specify	\$3,067.95

**Table with Power**

Product Dimensions (D x W)	Product Height (29", 36", or 42")	Single Laminate Color Option			Two Laminate Color Option				Markerboard Option			
		Item #	Color	List Price	Item #	Top/Outside Color	Under/Inside Color	List Price	Item #	Top/Outside Color	Lam Under/Inside Color	List Price
30 x 60 in	Specify	6-5004425-670	Specify	\$4,553.95	6-5004441-670	Specify	Specify	\$4,892.95	6-5004457-670	Specify	Specify	\$4,753.95
30 x 72 in	Specify	6-5004426-670	Specify	\$4,856.95	6-5004442-670	Specify	Specify	\$5,221.95	6-5004458-670	Specify	Specify	\$5,070.95
30 x 84 in	Specify	6-5004427-670	Specify	\$5,055.95	6-5004443-670	Specify	Specify	\$5,436.95	6-5004459-670	Specify	Specify	\$5,278.95
30 x 96 in	Specify	6-5004428-670	Specify	\$5,149.95	6-5004444-670	Specify	Specify	\$5,535.95	6-5004460-670	Specify	Specify	\$5,376.95
36 x 60 in	Specify	6-5004429-670	Specify	\$4,325.95	6-5004445-670	Specify	Specify	\$4,642.95	6-5004461-670	Specify	Specify	\$4,515.95
36 x 72 in	Specify	6-5004430-670	Specify	\$4,621.95	6-5004446-670	Specify	Specify	\$4,963.95	6-5004462-670	Specify	Specify	\$4,824.95
36 x 84 in	Specify	6-5004431-670	Specify	\$5,069.95	6-5004447-670	Specify	Specify	\$5,451.95	6-5004463-670	Specify	Specify	\$5,292.95
36 x 96 in	Specify	6-5004432-670	Specify	\$5,163.95	6-5004448-670	Specify	Specify	\$5,551.95	6-5004464-670	Specify	Specify	\$5,390.95
42 x 60 in	Specify	6-5004433-670	Specify	\$4,711.95	6-5004449-670	Specify	Specify	\$5,066.95	6-5004465-670	Specify	Specify	\$4,919.95
42 x 72 in	Specify	6-5004434-670	Specify	\$4,784.95	6-5004450-670	Specify	Specify	\$5,142.95	6-5004466-670	Specify	Specify	\$4,994.95
42 x 84 in	Specify	6-5004435-670	Specify	\$4,885.95	6-5004451-670	Specify	Specify	\$5,249.95	6-5004467-670	Specify	Specify	\$5,100.95
42 x 96 in	Specify	6-5004436-670	Specify	\$5,236.95	6-5004452-670	Specify	Specify	\$5,630.95	6-5004468-670	Specify	Specify	\$5,467.95
48 x 60 in	Specify	6-5004437-670	Specify	\$4,779.95	6-5004453-670	Specify	Specify	\$5,139.95	6-5004469-670	Specify	Specify	\$4,989.95
48 x 72 in	Specify	6-5004438-670	Specify	\$4,866.95	6-5004454-670	Specify	Specify	\$5,231.95	6-5004470-670	Specify	Specify	\$5,080.95
48 x 84 in	Specify	6-5004439-670	Specify	\$4,953.95	6-5004455-670	Specify	Specify	\$5,324.95	6-5004471-670	Specify	Specify	\$5,170.95
48 x 96 in	Specify	6-5004440-670	Specify	\$5,032.95	6-5004456-670	Specify	Specify	\$5,407.95	6-5004472-670	Specify	Specify	\$5,253.95

**Side Benches with Cushion**

Item Number	Product Dimensions	Laminate Color	Fabric Color	List Price
6-5004588-670	53W x 17D x 18H in	Specify	Specify	\$1,451.95
6-5004589-670	65W x 17D x 18H in	Specify	Specify	\$1,501.95
6-5004590-670	77W x 17D x 18H in	Specify	Specify	\$1,493.95
6-5004591-670	89W x 17D x 18H in	Specify	Specify	\$1,601.95

CLASSROOM  
SELECT



Double Sided



Single Sided

**Classroom Select® Community Storage Bench**

The Classroom Select® Community Storage Bench pairs perfectly with the Community Tables and Side Bench. Designed for libraries, lounge areas, and collaborative learning spaces, offered in a variety of width and depth options. Our storage benches can be ordered as a double-sided, for an extra roomy seat, or as a single-sided version, if space is limited. Choose from any of our 31 laminate colors and any of our 34 fabric choices.



Please refer to page 60-61 for all color selections.



PRODUCT CERTIFIED FOR LOW CHEMICAL EMISSIONS: UL.COM/IGG UL 2818

**Classroom Select® Coffee and Side Tables**

The Classroom Select® side tables and coffee tables are a perfect addition to our NeoLounge® and NeoLink® Soft Seating lines. Table tops are constructed from a 1 – 1/8" particle board core with your choice of any of 32 laminate tops and 23 T-Mold edge color options. The side table leg is a durable 2" round 17-gauge steel titanium powder coat finish. The side table base is made from a solid 3/4" thick steel plate, that slides perfectly under any of our soft seating chairs, making this a perfect add-on for your workspace needs. The Classroom Select® coffee table comes in a variety of shapes and sizes, that are suitable for any collaborative work environment. The coffee table features a uniquely designed tapered leg which offers a very aesthetically pleasing look.



Round Top Side Table



Oval Top Coffee Table



Rectangle Top Coffee Table

Item #	Description	Product Dimensions	Laminate Color	Edge Color	List Price
<b>Coffee Tables - Rectangle Top</b>					
6-5004159-670	Rectangle Laminate Top	48 W x 24 D x 16 H in	Specify	Specify	\$246.95
6-5004160-670	Rectangle Laminate Top	60 W x 30 D x 16 H in	Specify	Specify	\$308.95
6-5004787-670	Rectangle Markerboard Top	48 W x 24 D x 16 H in	White	Specify	\$261.95
6-5004788-670	Rectangle Markerboard Top	60 W x 30 D x 16 H in	White	Specify	\$346.95
<b>Coffee Tables - Oval Top</b>					
6-5004674-670	Oval Laminate Top	36 W x 18 D x 16 H in	Specify	Specify	\$223.95
6-5004675-670	Oval Laminate Top	48 W x 24 D x 16 H in	Specify	Specify	\$246.95
6-5004789-670	Oval Markerboard Top	36 W x 18 D x 16 H in	White	Specify	\$236.95
6-5004790-670	Oval Markerboard Top	48 W x 24 D x 16 H in	White	Specify	\$261.95
<b>Coffee Tables - Round Top</b>					
6-5004676-670	Round Laminate Top	36 W x 36 D x 16 H in	Specify	Specify	\$235.95
6-5004677-670	Round Laminate Top	48 W x 48 D x 16 H in	Specify	Specify	\$319.95
6-5004791-670	Round Markerboard Top	36 W x 36 D x 16 H in	White	Specify	\$252.95
6-5004792-670	Round Markerboard Top	48 W x 48 D x 16 H in	White	Specify	\$341.95
<b>Side Tables - Round Top</b>					
6-5004157-670	Round Laminate Top	20 W x 20 D x 26 H in	Specify	Specify	\$213.95
6-5004785-670	Round Markerboard Top	20 W x 20 D x 26 H in	White	Specify	\$227.95
<b>Side Tables - Square Top</b>					
6-5004158-670	Square Laminate Top	20 W x 20 D x 26 H in	Specify	Specify	\$216.95
6-5004786-670	Square Markerboard Top	20 W x 20 D x 26 H in	White	Specify	\$232.95





# cafeteria & food court

**CLASSROOM  
SELECT** 



PRODUCT CERTIFIED  
FOR LOW CHEMICAL  
EMISSIONS:  
UL SCQ1003  
UL 2818



PLEASE  
SPECIFY  
COLOR  
CHOICE

Refer to pages 60-61  
for color selections.



Two tables shown



Tables and Benches Fold and Nest for Easy Storage



Combine Single Bench Units with Standard Built-In Ganging Devices



Use as a Comfortable Bench Unit with Back for Assembly Seating



Rotate the Backrest 75° to Provide a Versatile Writing Surface

## Classroom Select® Convertible Bench Table

The convertible bench table is so versatile you can use it for a variety of multipurpose activities. A quick flip of the back rest converts your multipurpose room from an auditorium to a lecture hall. Table tops are constructed of high pressure laminate that is bonded to a 3/4" core and are available in MDF with LockEdge®, plywood with LockEdge® or T-Mold, and particleboard with T-Mold. Available in 27" or 29" heights. Positioning units facing each other transforms your facility into an efficient cafeteria. Multiple wheelchair position options and additional height options available (25" and 32"), please contact your School Specialty Account Manager for details and lead times. **Quickship available on 1433650 in Gray Nebula top and bench color and 29" height.**

Item #	Product Dimensions	Product Height	Top Type	Edge Type	Top Color	Seat Color	Frame Color	Edge Color	List Price
6-1433640-670	6 ft	Specify	Particleboard	T-Mold	Specify	Specify	Black	Specify	<b>\$1,083.95</b>
6-1433642-670	6 ft	Specify	Plywood	T-Mold	Specify	Specify	Black	Specify	<b>\$1,150.95</b>
6-1433641-670	6 ft	Specify	MDF	LockEdge	Specify	Specify	Black	Specify	<b>\$1,150.95</b>
6-1433643-670	6 ft	Specify	Plywood	LockEdge	Specify	Specify	Black	Specify	<b>\$1,316.95</b>
6-1433644-670	7 ft	Specify	Particleboard	T-Mold	Specify	Specify	Black	Specify	<b>\$1,150.95</b>
6-1433646-670	7 ft	Specify	Plywood	T-Mold	Specify	Specify	Black	Specify	<b>\$1,216.95</b>
6-1433645-670	7 ft	Specify	MDF	LockEdge	Specify	Specify	Black	Specify	<b>\$1,383.95</b>
6-1433647-670	7 ft	Specify	Plywood	LockEdge	Specify	Specify	Black	Specify	<b>\$1,383.95</b>
6-1433648-670	8 ft	Specify	Particleboard	T-Mold	Specify	Specify	Black	Specify	<b>\$1,216.95</b>
6-1433651-670	8 ft	Specify	Plywood	T-Mold	Specify	Specify	Black	Specify	<b>\$1,283.95</b>
6-1433650-670	8 ft	Specify	MDF	LockEdge	Specify	Specify	Black	Specify	<b>\$1,450.95</b>
6-1433652-670	8 ft	Specify	Plywood	LockEdge	Specify	Specify	Black	Specify	<b>\$1,450.95</b>



**QUICKSHIP**  
Items ship within 24 hrs, 48 hrs, 1 or 2 weeks as indicated when the factory distribution center receives the order.

Items ship **Freight** or **Parcel**

See Shipping & Handling terms for details.

CLASSROOM  
SELECT 



PRODUCT CERTIFIED  
FOR LOW CHEMICAL  
EMISSIONS:  
UL COMGG  
UL 2818



Refer to pages 60-61  
for color options.



**Classroom Select® Mobile SimpleStore® Tables**

The Mobile SimpleStore® is perfect for cafeterias that require a multipurpose space filled with furniture that can serve many purposes. The 14-gauge steel, 2" tube legs and double ball bearing non-marring locking 3" casters allow mobility and strength when used. High backs with a slight 12-degree pitch provide the perfect contour for comfortable seating. Rubber Grip-Right glides engage on the floor when opened. The locking casters also allow this table to stay in place. The table is a rectangular shape with a textured black powdercoat frame. Available in an assortment of laminate color options, these mobile tables are the perfect addition to any cafeteria environment. Sold in full booth unit, individual tables, and bench options. Tables with T-Mold edge are made of 1" particleboard core, and LockEdge® are made of 1" MDF core with high pressure laminate top. Benches are 3/4" thick.

Item #	Product Dimensions	Edge Type	Top Color	Seat Color	Frame Color	Edge Color	Back Color	List Price
<b>Mobile Booth Systems</b>								
6-5003882-670	24W x 48D x 39-1/2H in	T-Mold	Specify	Specify	Black	Specify	Specify	\$3,029.95
6-5003887-670	24W x 60D x 39-1/2H in	T-Mold	Specify	Specify	Black	Specify	Specify	\$3,289.95
6-5003890-670	30W x 48D x 39-1/2H in	T-Mold	Specify	Specify	Black	Specify	Specify	\$3,073.95
6-5003883-670	30W x 60D x 39-1/2H in	T-Mold	Specify	Specify	Black	Specify	Specify	\$3,330.95
6-5003892-670	48W x 24D x 39-1/2H in	LockEdge	Specify	Specify	Black	Specify	Specify	\$3,229.95
6-5003888-670	60W x 24D x 39-1/2H in	LockEdge	Specify	Specify	Black	Specify	Specify	\$3,489.95
6-5003881-670	48W x 30D x 39-1/2H in	LockEdge	Specify	Specify	Black	Specify	Specify	\$3,273.95
6-5003891-670	60W x 30D x 39-1/2H in	LockEdge	Specify	Specify	Black	Specify	Specify	\$3,530.95
<b>Benches</b>								
6-5003889-670	48W x 25D x 38H in	T-Mold	-	Specify	Black	Specify	Specify	\$1,055.95
6-5003884-670	60W x 25D x 38H in	T-Mold	-	Specify	Black	Specify	Specify	\$1,134.95
6-5003885-670	48W x 25D x 38H in	LockEdge	-	Specify	Black	Specify	Specify	\$1,155.95
6-5003886-670	60W x 25D x 38H in	LockEdge	-	Specify	Black	Specify	Specify	\$1,234.95





### Classroom Select® Mobile SimpleStore® Tables

The Mobile SimpleStore® is perfect for cafeterias that require a multipurpose space filled with furniture that can serve many purposes. The 14-gauge steel, 2" tube legs and double ball bearing non-marring locking 3" casters allow mobility and strength when used. High backs with a slight 12-degree pitch provide the perfect contour for comfortable seating. Rubber Grip-Right glides engage on the floor when opened. The locking casters also allow this table to stay in place. The table is a rectangular shape with a textured black powdercoat frame. Available in an assortment of laminate color options, these mobile tables are the perfect addition to any cafeteria environment. Sold in full booth unit, individual tables, and bench options. Tables with T-Mold edge are made of 1" particleboard core, and LockEdge® are made of 1" MDF core with high pressure laminate top. Benches are 3/4" thick.

Item #	Product Dimensions	Top Type	Edge Type	Top Color	Frame Color	Edge Color	List Price
<b>6-5003893-670</b>	48W x 24D x 29H in	Laminate	T-Mold	Specify	Black	Specify	<b>\$917.95</b>
<b>6-5003895-670</b>	60W x 24D x 29H in	Laminate	T-Mold	Specify	Black	Specify	<b>\$1,020.95</b>
<b>6-5003900-670</b>	48W x 30D x 29H in	Laminate	T-Mold	Specify	Black	Specify	<b>\$962.95</b>
<b>6-5003894-670</b>	60W x 30D x 29H in	Laminate	T-Mold	Specify	Black	Specify	<b>\$1,061.95</b>
<b>6-5003898-670</b>	48W x 24D x 29H in	Laminate	LockEdge	Specify	Black	Specify	<b>\$1,017.95</b>
<b>6-5003897-670</b>	60W x 24D x 29H in	Laminate	LockEdge	Specify	Black	Specify	<b>\$1,120.95</b>
<b>6-5003899-670</b>	48W x 30D x 29H in	Laminate	LockEdge	Specify	Black	Specify	<b>\$1,062.95</b>
<b>6-5003896-670</b>	60W x 30D x 29H in	Laminate	LockEdge	Specify	Black	Specify	<b>\$1,161.95</b>



CLASSROOM  
SELECT 

ALL ITEMS ON THIS PAGE HAVE A  
LIMITED  
**LIFETIME**  
WARRANTY

PLEASE SPECIFY  
**COLOR CHOICE**  
Refer to pages 60-61  
for color options.

 **GREENGUARD**  
GOLD  
PRODUCT CERTIFIED  
FOR LOW CHEMICAL  
EMISSIONS:  
UL CQM7GG  
UL 2818

 **ADA**  
COMPLIANT



Storage latch release handles  
on either side for easy access



### Classroom Select® Mobile Table with Benches

The mobile fixed-bench table features a two-stage security lock that secures table in an open position as well as partially opened for floor maintenance. Also, an exclusive torsion bar easy-lift system, providing for smooth and easy opening and closing every step of the way. This unit features a lift-off caster leg design to ensure table does not roll while in use and a 4" rubber, non-marking locking wheels for easy mobility. Available in a 27" or 29" height. Benches and table tops are constructed of high pressure laminate that is bonded to a 3/4" core and are available in MDF with colored LockEdge®, plywood with colored LockEdge® or colored T-Mold, and particleboard with colored T-Mold. Please contact your School Specialty Account Manager for ADA options, additional heights (25" or 32"), table configurations, and lead time details.

Quickship available on 1433670 and 1433674 in MDF with LockEdge® Gray Nebula top and bench colors and 29" height.

Item #	Shape	Product Dimensions	Product Height	Top Type	Edge Type	Top Color	Seat Color	Frame Color	List Price
6-1433653-670	Rectangle	8 ft	Specify	Particleboard	T-Mold	Specify	Specify	Chrome	\$2,222.95
6-1433654-670	Rectangle	8 ft	Specify	MDF	LockEdge	Specify	Specify	Chrome	\$2,555.95
6-1433655-670	Rectangle	8 ft	Specify	Plywood	T-Mold	Specify	Specify	Chrome	\$2,622.95
6-1433656-670	Rectangle	8 ft	Specify	Plywood	LockEdge	Specify	Specify	Chrome	\$2,889.95
6-1433657-670	Rectangle	8 ft	Specify	Particleboard	T-Mold	Specify	Specify	Black	\$2,022.95
6-1433658-670	Rectangle	8 ft	Specify	MDF	LockEdge	Specify	Specify	Black	\$2,355.95
6-1433659-670	Rectangle	8 ft	Specify	Plywood	T-Mold	Specify	Specify	Black	\$2,422.95
6-1433660-670	Rectangle	8 ft	Specify	Plywood	LockEdge	Specify	Specify	Black	\$2,689.95
6-1433661-670	Rectangle	10 ft	Specify	Particleboard	T-Mold	Specify	Specify	Chrome	\$2,422.95
6-1433662-670	Rectangle	10 ft	Specify	MDF	LockEdge	Specify	Specify	Chrome	\$2,755.95
6-1433663-670	Rectangle	10 ft	Specify	Plywood	T-Mold	Specify	Specify	Chrome	\$2,822.95
6-1433664-670	Rectangle	10 ft	Specify	Plywood	LockEdge	Specify	Specify	Chrome	\$3,089.95
6-1433665-670	Rectangle	10 ft	Specify	Particleboard	T-Mold	Specify	Specify	Black	\$2,222.95
6-1433666-670	Rectangle	10 ft	Specify	MDF	LockEdge	Specify	Specify	Black	\$2,555.95
6-1433667-670	Rectangle	10 ft	Specify	Plywood	T-Mold	Specify	Specify	Black	\$2,622.95
6-1433668-670	Rectangle	10 ft	Specify	Plywood	LockEdge	Specify	Specify	Black	\$2,889.95
6-1433669-670	Rectangle	12 ft	Specify	Particleboard	T-Mold	Specify	Specify	Chrome	\$2,622.95
6-1433670-670	Rectangle	12 ft	Specify	MDF	LockEdge	Specify	Specify	Chrome	\$2,955.95
6-1433671-670	Rectangle	12 ft	Specify	Plywood	T-Mold	Specify	Specify	Chrome	\$3,022.95
6-1433672-670	Rectangle	12 ft	Specify	Plywood	LockEdge	Specify	Specify	Chrome	\$3,289.95
6-1433673-670	Rectangle	12 ft	Specify	Particleboard	T-Mold	Specify	Specify	Black	\$2,422.95
6-1433674-670	Rectangle	12 ft	Specify	MDF	LockEdge	Specify	Specify	Black	\$2,755.95
6-1433675-670	Rectangle	12 ft	Specify	Plywood	T-Mold	Specify	Specify	Black	\$2,822.95
6-1433676-670	Rectangle	12 ft	Specify	Plywood	LockEdge	Specify	Specify	Black	\$3,089.95



PRODUCT CERTIFIED FOR LOW CHEMICAL EMISSIONS: UL.COM/1GG UL 2818



Refer to pages 60-61 for color options.



Item #	Shape	Product Dimensions	Product Height	Top Type	Edge Type	Top Color	Seat Color	Frame Color	List Price
6-1441000-670	Elliptical	10 ft	Specify	Particleboard	T-Mold	Specify	Specify	Chrome	\$3,222.95
6-1441001-670	Elliptical	10 ft	Specify	MDF	LockEdge	Specify	Specify	Chrome	\$3,555.95
6-1441002-670	Elliptical	10 ft	Specify	Plywood	T-Mold	Specify	Specify	Chrome	\$3,622.95
6-1441003-670	Elliptical	10 ft	Specify	Plywood	LockEdge	Specify	Specify	Chrome	\$3,889.95
6-1441004-670	Elliptical	10 ft	Specify	Particleboard	T-Mold	Specify	Specify	Black	\$3,022.95
6-1441005-670	Elliptical	10 ft	Specify	MDF	LockEdge	Specify	Specify	Black	\$3,355.95
6-1441006-670	Elliptical	10 ft	Specify	Plywood	T-Mold	Specify	Specify	Black	\$3,422.95
6-1441007-670	Elliptical	10 ft	Specify	Plywood	LockEdge	Specify	Specify	Black	\$3,689.95



Item #	Shape	Product Dimensions	Product Height	Top Type	Edge Type	Top Color	Seat Color	Frame Color	List Price
6-1441008-670	Round	60 in	Specify	Particleboard	T-Mold	Specify	Specify	Chrome	\$3,222.95
6-1441009-670	Round	60 in	Specify	MDF	LockEdge	Specify	Specify	Chrome	\$3,555.95
6-1441010-670	Round	60 in	Specify	Plywood	T-Mold	Specify	Specify	Chrome	\$3,622.95
6-1441011-670	Round	60 in	Specify	Plywood	LockEdge	Specify	Specify	Chrome	\$3,889.95
6-1441012-670	Round	60 in	Specify	Particleboard	T-Mold	Specify	Specify	Black	\$3,022.95
6-1441013-670	Round	60 in	Specify	MDF	LockEdge	Specify	Specify	Black	\$3,355.95
6-1441014-670	Round	60 in	Specify	Plywood	T-Mold	Specify	Specify	Black	\$3,422.95
6-1441015-670	Round	60 in	Specify	Plywood	LockEdge	Specify	Specify	Black	\$3,689.95
6-5002824-670	Octagon	60 in	29 in	Particleboard	T-Mold	Specify	Specify	Chrome	\$3,222.95
6-5002849-670	Octagon	60 in	29 in	MDF	LockEdge	Specify	Specify	Chrome	\$3,555.95
6-5002850-670	Octagon	60 in	29 in	Plywood	T-Mold	Specify	Specify	Chrome	\$3,622.95
6-5002851-670	Octagon	60 in	29 in	Plywood	LockEdge	Specify	Specify	Chrome	\$3,889.95
6-5002852-670	Octagon	60 in	29 in	Particleboard	T-Mold	Specify	Specify	Black	\$3,022.95
6-5002853-670	Octagon	60 in	29 in	MDF	LockEdge	Specify	Specify	Black	\$3,355.95
6-5002854-670	Octagon	60 in	29 in	Plywood	T-Mold	Specify	Specify	Black	\$3,422.95
6-5002855-670	Octagon	60 in	29 in	Plywood	LockEdge	Specify	Specify	Black	\$3,689.95

**CLASSROOM  
SELECT** 

 PLEASE SPECIFY COLOR CHOICE  
Refer to pages 60-61 for color options.

 LIMITED WARRANTY

 UL GREENGUARD

PRODUCT CERTIFIED FOR LOW CHEMICAL EMISSIONS: UL.COM/SGG UL 2818

 UL

 ADA COMPLIANT



Storage latch release handles on either side for easy access

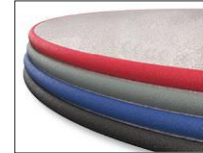

LockEdge® polyurethane edge provides cleanliness and durability



### Classroom Select® Mobile Table with Stools

The Classroom Select® mobile stool table can fit any cafeteria need. All tables have 13" diameter stools that require installation, and 30" wide tops. Features an exclusive torsion bar easy-lift system, providing for smooth and easy opening and closing every step of the way. A lift-off caster leg design to ensure table does not roll while in use; 4" rubber, non-marking wheels for easy mobility. Table tops are constructed of high pressure laminate that is bonded to a 3/4" core and are available in MDF with colored LockEdge®, plywood with colored LockEdge® or colored T-Mold, and particleboard with colored T-Mold. Available heights are 27" or 29". Perfect for use as an arts and crafts table, as a learning center for educational programs, or as a cafeteria table.

Item #	Shape	Product Dimensions	Number of Seats	Product Height	Top Type	Edge Type	Top Color	Seat Color	Frame Color	Edge Color	List Price
6-1433615-670	Rectangle	8 ft	8	Specify	Particleboard	T-Mold	Specify	Specify	Chrome	Specify	\$2,331.95
6-1433616-670	Rectangle	8 ft	8	Specify	MDF	LockEdge	Specify	Specify	Chrome	Specify	\$2,664.95
6-1433617-670	Rectangle	8 ft	8	Specify	Plywood	T-Mold	Specify	Specify	Chrome	Specify	\$2,731.95
6-1433618-670	Rectangle	8 ft	8	Specify	Plywood	LockEdge	Specify	Specify	Chrome	Specify	\$2,998.95
6-1433619-670	Rectangle	8 ft	8	Specify	Particleboard	T-Mold	Specify	Specify	Black	Specify	\$2,131.95
6-1433620-670	Rectangle	8 ft	8	Specify	MDF	LockEdge	Specify	Specify	Black	Specify	\$2,464.95
6-1433621-670	Rectangle	8 ft	8	Specify	Plywood	T-Mold	Specify	Specify	Black	Specify	\$2,531.95
6-1433622-670	Rectangle	8 ft	8	Specify	Plywood	LockEdge	Specify	Specify	Black	Specify	\$2,798.95
6-1433623-670	Rectangle	10 ft	12	Specify	Particleboard	T-Mold	Specify	Specify	Chrome	Specify	\$2,531.95
6-1433624-670	Rectangle	10 ft	12	Specify	MDF	LockEdge	Specify	Specify	Chrome	Specify	\$2,864.95
6-1433625-670	Rectangle	10 ft	12	Specify	Plywood	T-Mold	Specify	Specify	Chrome	Specify	\$2,931.95
6-1433626-670	Rectangle	10 ft	12	Specify	Plywood	LockEdge	Specify	Specify	Chrome	Specify	\$3,198.95
6-1433627-670	Rectangle	10 ft	12	Specify	Particleboard	T-Mold	Specify	Specify	Black	Specify	\$2,331.95
6-1433628-670	Rectangle	10 ft	12	Specify	MDF	LockEdge	Specify	Specify	Black	Specify	\$2,664.95
6-1433629-670	Rectangle	10 ft	12	Specify	Plywood	T-Mold	Specify	Specify	Black	Specify	\$2,731.95
6-1433630-670	Rectangle	10 ft	12	Specify	Plywood	LockEdge	Specify	Specify	Black	Specify	\$2,998.95
6-1433631-670	Rectangle	12 ft	12	Specify	Particleboard	T-Mold	Specify	Specify	Chrome	Specify	\$2,731.95
6-1433632-670	Rectangle	12 ft	12	Specify	MDF	LockEdge	Specify	Specify	Chrome	Specify	\$3,064.95
6-1433633-670	Rectangle	12 ft	12	Specify	Plywood	T-Mold	Specify	Specify	Chrome	Specify	\$3,131.95
6-1433634-670	Rectangle	12 ft	12	Specify	Plywood	LockEdge	Specify	Specify	Chrome	Specify	\$3,398.95
6-1433635-670	Rectangle	12 ft	12	Specify	Particleboard	T-Mold	Specify	Specify	Black	Specify	\$2,531.95
6-1433636-670	Rectangle	12 ft	12	Specify	MDF	LockEdge	Specify	Specify	Black	Specify	\$2,864.95
6-1433637-670	Rectangle	12 ft	12	Specify	Plywood	T-Mold	Specify	Specify	Black	Specify	\$2,931.95
6-1433638-670	Rectangle	12 ft	12	Specify	Plywood	LockEdge	Specify	Specify	Black	Specify	\$3,198.95



**CLASSROOM  
SELECT** 

 PLEASE SPECIFY  
COLOR CHOICE

Refer to pages 60-61  
for color options.

 LIMITED  
WARRANTY

 GREENGUARD

PRODUCT CERTIFIED  
FOR LOW CHEMICAL  
EMISSIONS:  
UL.COM/SGG  
UL 2818

 UL

 ADA  
COMPLIANT



Item #	Shape	Product Dimensions	Number of Seats	Product Height	Top Type	Edge Type	Top Color	Seat Color	Frame Color	Edge Color	List Price
6-1440984-670	Elliptical	10 ft	12	Specify	Particleboard	T-Mold	Specify	Specify	Chrome	Specify	\$3,331.95
6-1440985-670	Elliptical	10 ft	12	Specify	MDF	LockEdge	Specify	Specify	Chrome	Specify	\$3,664.95
6-1440986-670	Elliptical	10 ft	12	Specify	Plywood	T-Mold	Specify	Specify	Chrome	Specify	\$3,731.95
6-1440987-670	Elliptical	10 ft	12	Specify	Plywood	LockEdge	Specify	Specify	Chrome	Specify	\$3,998.95
6-1440988-670	Elliptical	10 ft	12	Specify	Particleboard	T-Mold	Specify	Specify	Black	Specify	\$3,131.95
6-1440989-670	Elliptical	10 ft	12	Specify	MDF	LockEdge	Specify	Specify	Black	Specify	\$3,464.95
6-1440990-670	Elliptical	10 ft	12	Specify	Plywood	T-Mold	Specify	Specify	Black	Specify	\$3,531.95
6-1440991-670	Elliptical	10 ft	12	Specify	Plywood	LockEdge	Specify	Specify	Black	Specify	\$3,798.95



Item #	Shape	Product Dimensions	Number of Seats	Product Height	Top Type	Edge Type	Top Color	Seat Color	Frame Color	Edge Color	List Price
6-1440992-670	Round	60 in	8	Specify	Particleboard	T-Mold	Specify	Specify	Chrome	Specify	\$2,664.95
6-1440993-670	Round	60 in	8	Specify	MDF	LockEdge	Specify	Specify	Chrome	Specify	\$2,998.95
6-1440994-670	Round	60 in	8	Specify	Plywood	T-Mold	Specify	Specify	Chrome	Specify	\$3,064.95
6-1440995-670	Round	60 in	0	Specify	Plywood	LockEdge	Specify	Specify	Chrome	Specify	\$3,331.95
6-1440996-670	Round	60 in	8	Specify	Particleboard	T-Mold	Specify	Specify	Black	Specify	\$2,464.95
6-1440997-670	Round	60 in	8	Specify	MDF	LockEdge	Specify	Specify	Black	Specify	\$2,798.95
6-1440998-670	Round	60 in	8	Specify	Plywood	T-Mold	Specify	Specify	Black	Specify	\$2,864.95
6-1440999-670	Round	60 in	8	Specify	Plywood	LockEdge	Specify	Specify	Black	Specify	\$3,131.95
6-5002816-670	Octagon	60 in	8	Specify	Particleboard	T-Mold	Specify	Specify	Chrome	Specify	\$2,664.95
6-5002817-670	Octagon	60 in	8	Specify	MDF	LockEdge	Specify	Specify	Chrome	Specify	\$2,998.95
6-5002818-670	Octagon	60 in	8	Specify	Plywood	T-Mold	Specify	Specify	Chrome	Specify	\$3,064.95
6-5002819-670	Octagon	60 in	8	Specify	Plywood	LockEdge	Specify	Specify	Chrome	Specify	\$3,331.95
6-5002820-670	Octagon	60 in	8	Specify	Particleboard	T-Mold	Specify	Specify	Black	Specify	\$2,464.95
6-5002821-670	Octagon	60 in	8	Specify	MDF	LockEdge	Specify	Specify	Black	Specify	\$2,798.95
6-5002822-670	Octagon	60 in	8	Specify	Plywood	T-Mold	Specify	Specify	Black	Specify	\$2,864.95
6-5002823-670	Octagon	60 in	8	Specify	Plywood	LockEdge	Specify	Specify	Black	Specify	\$3,131.95

**Classroom Select® Cafeteria Table Stool Colors**

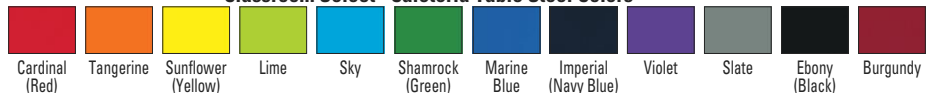



PRODUCT CERTIFIED FOR LOW CHEMICAL EMISSIONS: UL COMING UL 2818



PLEASE SPECIFY COLOR CHOICE  
Refer to pages 60-61 for color selections.



**Classroom Select® EasyFold Mobile Table**

The one-piece design and durable structure make this the perfect multi-purpose table for cafeterias, banquets, and most events. When opened, this is a seamless surface that automatically locks with two points of manual release to fold and can be nested for easy storage. 4" double ball bearing swivel casters allow for easy transportation and lift off the floor in an open position to prevent table from rocking or shifting. Glass-filled nylon, high-impact glides allow no leftover marks when moving. 14-gauge steel understructure and legs are available in textured powder coat black and chrome options. Each table model is designed for years of dependable use with tops constructed of high pressure laminate that is bonded to a 3/4" core and are available in MDF with colored LockEdge®, plywood with colored LockEdge® or colored T-Mold, and particleboard with colored T-molding. Standard height is 29", with optional 27" height available upon request.

Top Type	Edge Type	Edge Color	Top Color	Frame Color	Round 48 W x 48 D in		Round 60 W x 60 D in	
					Item #	List Price	Item #	List Price
Particle Board	T-Mold	Specify	Specify	Chrome	6-5002808-670	\$1,605.95	6-5000396-670	\$1,738.95
MDF	LockEdge	Specify	Specify	Chrome	6-5002809-670	\$1,938.95	6-5000636-670	\$2,072.95
Plywood	T-Mold	Specify	Specify	Chrome	6-5002810-670	\$1,872.95	6-5000633-670	\$2,005.95
Plywood	LockEdge	Specify	Specify	Chrome	6-5002811-670	\$2,138.95	6-5000634-670	\$2,272.95
Particle Board	T-Mold	Specify	Specify	Black	6-5002812-670	\$1,405.95	6-5000645-670	\$1,538.95
MDF	LockEdge	Specify	Specify	Black	6-5002813-670	\$1,738.95	6-5000647-670	\$1,872.95
Plywood	T-Mold	Specify	Specify	Black	6-5002814-670	\$1,672.95	6-5000648-670	\$1,805.95
Plywood	LockEdge	Specify	Specify	Black	6-5002815-670	\$1,938.95	6-5000643-670	\$2,072.95

Top Type	Edge Type	Edge Color	Top Color	Frame Color	Square 48 W x 48 D in		Square 60 W x 60 D in	
					Item #	List Price	Item #	List Price
Particle Board	T-Mold	Specify	Specify	Chrome	6-5002792-670	\$1,605.95	6-5000398-670	\$1,738.95
MDF	LockEdge	Specify	Specify	Chrome	6-5002793-670	\$1,938.95	6-5000668-670	\$2,072.95
Plywood	T-Mold	Specify	Specify	Chrome	6-5002794-670	\$1,872.95	6-5000678-670	\$2,005.95
Plywood	LockEdge	Specify	Specify	Chrome	6-5002795-670	\$2,138.95	6-5000675-670	\$2,272.95
Particle Board	T-Mold	Specify	Specify	Black	6-5002796-670	\$1,405.95	6-5000671-670	\$1,538.95
MDF	LockEdge	Specify	Specify	Black	6-5002797-670	\$1,738.95	6-5000669-670	\$1,872.95
Plywood	T-Mold	Specify	Specify	Black	6-5002798-670	\$1,672.95	6-5000677-670	\$1,805.95
Plywood	LockEdge	Specify	Specify	Black	6-5002799-670	\$1,938.95	6-5000676-670	\$2,072.95

**CLASSROOM  
SELECT**



PRODUCT CERTIFIED  
FOR LOW CHEMICAL  
EMISSIONS:  
UL-COMF5G  
UL 2818



PLEASE  
SPECIFY  
COLOR  
CHOICE

Refer to pages 60-61  
for color selections.



Top Type	Edge Type	Edge Color	Top Color	Frame Color	Hexagon 60 W x 60 D in		Hexagon 48 W x 48 D in	
					Item #	List Price	Item #	List Price
Particle Board	T-Mold	Specify	Specify	Chrome	6-5000399-670	\$1,738.95	6-5002800-670	\$1,605.95
MDF	LockEdge	Specify	Specify	Chrome	6-5000691-670	\$2,072.95	6-5002801-670	\$1,938.95
Plywood	T-Mold	Specify	Specify	Chrome	6-5000696-670	\$2,005.95	6-5002802-670	\$1,872.95
Plywood	LockEdge	Specify	Specify	Chrome	6-5000700-670	\$2,272.95	6-5002803-670	\$2,138.95
Particle Board	T-Mold	Specify	Specify	Black	6-5000695-670	\$1,538.95	6-5002804-670	\$1,405.95
MDF	LockEdge	Specify	Specify	Black	6-5000692-670	\$1,872.95	6-5002805-670	\$1,738.95
Plywood	T-Mold	Specify	Specify	Black	6-5000698-670	\$1,805.95	6-5002806-670	\$1,672.95
Plywood	LockEdge	Specify	Specify	Black	6-5000699-670	\$2,072.95	6-5002807-670	\$1,938.95

Top Type	Edge Type	Edge Color	Top Color	Frame Color	Octagon 60 W x 60 D in	
					Item #	List Price
Particle Board	T-Mold	Specify	Specify	Chrome	6-5000401-670	\$1,738.95
MDF	LockEdge	Specify	Specify	Chrome	6-5000721-670	\$2,072.95
Plywood	T-Mold	Specify	Specify	Chrome	6-5000727-670	\$2,005.95
Plywood	LockEdge	Specify	Specify	Chrome	6-5000730-670	\$2,272.95
Particle Board	T-Mold	Specify	Specify	Black	6-5000724-670	\$1,538.95
MDF	LockEdge	Specify	Specify	Black	6-5000722-670	\$1,872.95
Plywood	T-Mold	Specify	Specify	Black	6-5000728-670	\$1,805.95
Plywood	LockEdge	Specify	Specify	Black	6-5000729-670	\$2,072.95

Top Type	Edge Type	Edge Color	Top Color	Frame Color	Oval 60 W x 60 D in	
					Item #	List Price
Particle Board	T-Mold	Specify	Specify	Chrome	6-5000400-670	\$1,938.95
MDF	LockEdge	Specify	Specify	Chrome	6-5000713-670	\$2,272.95
Plywood	T-Mold	Specify	Specify	Chrome	6-5000716-670	\$2,205.95
Plywood	LockEdge	Specify	Specify	Chrome	6-5000719-670	\$2,472.95
Particle Board	T-Mold	Specify	Specify	Black	6-5000710-670	\$1,738.95
MDF	LockEdge	Specify	Specify	Black	6-5000712-670	\$2,072.95
Plywood	T-Mold	Specify	Specify	Black	6-5000717-670	\$2,005.95
Plywood	LockEdge	Specify	Specify	Black	6-5000718-670	\$2,272.95



**PLEASE SPECIFY COLOR CHOICE**  
 Refer to pages 60-61 for color options.



PRODUCT CERTIFIED FOR LOW CHEMICAL EMISSIONS: UL COM/CGG UL 2918



Rectangle



Elliptical



**Classroom Select® Mobile Shape Tables**

A well balanced strong underside construction keeps these tables flat and sturdy for years of service. Value-priced tables to "roll and unfold" for school luncheons, banquets, bake sales, scouting affairs, and other school functions. The rectangular tables feature an exclusive torsion bar easy-lift system, providing for smooth and easy opening and closing every step of the way. Table tops are constructed of high pressure laminate that is bonded to a 3/4" core and are available in MDF with colored LockEdge®, plywood with colored LockEdge® or colored T-Mold, and particleboard with colored T-Mold. A generous 1-1/8" gap between tops prevent pinching. This unit features a lift-off caster leg design to ensure table does not roll while in use; rubber, non-marking wheels are 4" in diameter for easy mobility. Please contact your School Specialty Account Manager for ADA options, table configurations, and lead time details. Standard height is 29", but it is also available in 27".

Item #	Shape	Product Dimensions	Product Height	Top Type	Edge Type	Edge Color	Top Color	Frame Color	List Price
6-1441016-670	Rectangle	8 ft	Specify	Particleboard	T-Mold	Specify	Specify	Chrome	\$1,486.95
6-1441017-670	Rectangle	8 ft	Specify	MDF	LockEdge	Specify	Specify	Chrome	\$1,653.95
6-1441018-670	Rectangle	8 ft	Specify	Plywood	T-Mold	Specify	Specify	Chrome	\$1,619.95
6-1441019-670	Rectangle	8 ft	Specify	Plywood	LockEdge	Specify	Specify	Chrome	\$1,753.95
6-1441020-670	Rectangle	8 ft	Specify	Particleboard	T-Mold	Specify	Specify	Black	\$1,386.95
6-1441021-670	Rectangle	8 ft	Specify	MDF	LockEdge	Specify	Specify	Black	\$1,553.95
6-1441022-670	Rectangle	8 ft	Specify	Plywood	T-Mold	Specify	Specify	Black	\$1,519.95
6-1441023-670	Rectangle	8 ft	Specify	Plywood	LockEdge	Specify	Specify	Black	\$1,653.95
6-1441024-670	Rectangle	10 ft	Specify	Particleboard	T-Mold	Specify	Specify	Chrome	\$1,619.95
6-1441025-670	Rectangle	10 ft	Specify	MDF	LockEdge	Specify	Specify	Chrome	\$1,786.95
6-1441026-670	Rectangle	10 ft	Specify	Plywood	T-Mold	Specify	Specify	Chrome	\$1,753.95
6-1441027-670	Rectangle	10 ft	Specify	Plywood	LockEdge	Specify	Specify	Chrome	\$1,886.95
6-1441028-670	Rectangle	10 ft	Specify	Particleboard	T-Mold	Specify	Specify	Black	\$1,519.95
6-1441029-670	Rectangle	10 ft	Specify	MDF	LockEdge	Specify	Specify	Black	\$1,686.95
6-1441030-670	Rectangle	10 ft	Specify	Plywood	T-Mold	Specify	Specify	Black	\$1,653.95
6-1441031-670	Rectangle	10 ft	Specify	Plywood	LockEdge	Specify	Specify	Black	\$1,786.95
6-1441032-670	Rectangle	12 ft	Specify	Particleboard	T-Mold	Specify	Specify	Chrome	\$1,686.95
6-1441033-670	Rectangle	12 ft	Specify	MDF	LockEdge	Specify	Specify	Chrome	\$1,853.95
6-1441034-670	Rectangle	12 ft	Specify	Plywood	T-Mold	Specify	Specify	Chrome	\$1,819.95
6-1441035-670	Rectangle	12 ft	Specify	Plywood	LockEdge	Specify	Specify	Chrome	\$1,953.95
6-1441036-670	Rectangle	12 ft	Specify	Particleboard	T-Mold	Specify	Specify	Black	\$1,586.95
6-1441037-670	Rectangle	12 ft	Specify	MDF	LockEdge	Specify	Specify	Black	\$1,753.95
6-1441038-670	Rectangle	12 ft	Specify	Plywood	T-Mold	Specify	Specify	Black	\$1,719.95
6-1441039-670	Rectangle	12 ft	Specify	Plywood	LockEdge	Specify	Specify	Black	\$1,853.95

Item #	Shape	Product Dimensions	Product Height	Top Type	Edge Type	Edge Color	Top Color	Frame Color	List Price
6-5002884-670	Elliptical	45W x 120L in	Specify	Particleboard	T-Mold	Specify	Specify	Chrome	\$2,153.95
6-5002885-670	Elliptical	45W x 120L in	Specify	MDF	LockEdge	Specify	Specify	Chrome	\$2,319.95
6-5002886-670	Elliptical	45W x 120L in	Specify	Plywood	T-Mold	Specify	Specify	Chrome	\$2,286.95
6-5002887-670	Elliptical	45W x 120L in	Specify	Plywood	LockEdge	Specify	Specify	Chrome	\$2,419.95
6-5002888-670	Elliptical	45W x 120L in	Specify	Particleboard	T-Mold	Specify	Specify	Black	\$2,053.95
6-5002889-670	Elliptical	45W x 120L in	Specify	MDF	LockEdge	Specify	Specify	Black	\$2,219.95
6-5002890-670	Elliptical	45W x 120L in	Specify	Plywood	T-Mold	Specify	Specify	Black	\$2,186.95
6-5002891-670	Elliptical	45W x 120L in	Specify	Plywood	LockEdge	Specify	Specify	Black	\$2,319.95

**PLEASE SPECIFY COLOR CHOICE**  
Refer to pages 60-61 for color options.



PRODUCT CERTIFIED FOR LOW CHEMICAL EMISSIONS: UL COM10G UL 2815

**CLASSROOM SELECT**



**Classroom Select® Tilt-N-Nest® Café Table**

The Classroom Select® multifunctional Tilt-N-Nest® Café Table can be used in several school learning environments. Simple and easy height adjustment lever raises the table from 29" to 44-1/2". Table top flips down into place and can be easily nested with other tables for safe compact storage. Tables tilt and stop at users choice. Durable heavy-duty steel column and base with 60mm locking casters allow smooth transitions and secure nesting. Tops available in square and round shapes; sizes 24", 30", and 36". Choose from 32 laminate colors including markerboard top, in LockEdge® or T-Mold edge band. Coordinate the edge color by choosing among any of our 5 LockEdge® or 23 T-Mold color options. Bases available in black powdercoat.

Item #	Product Dimensions	Top Type	Edge Type	Edge Color	Top Color	List Price
<b>Round with Laminate</b>						
6-5002846-670	24 W x 24 D x 29 - 44-1/2 H in	Laminate	T-Mold	Specify	Specify	\$428.95
6-5002834-670	24 W x 24 D x 29 - 44-1/2 H in	Laminate	LockEdge	Specify	Specify	\$461.95
6-5002825-670	30 W x 30 D x 29 - 44-1/2 H in	Laminate	T-Mold	Specify	Specify	\$461.95
6-5002840-670	30 W x 30 D x 29 - 44-1/2 H in	Laminate	LockEdge	Specify	Specify	\$528.95
6-5002838-670	36 W x 36 D x 29 - 44-1/2 H in	Laminate	T-Mold	Specify	Specify	\$495.95
6-5002842-670	36 W x 36 D x 29 - 44-1/2 H in	Laminate	LockEdge	Specify	Specify	\$528.95
<b>Round with Markerboard</b>						
6-5002830-670	24 W x 24 D x 29 - 44-1/2 H in	Markerboard	T-Mold	Specify	White	\$448.95
6-5004849-670	24 W x 24 D x 29 - 44-1/2 H in	Markerboard	LockEdge	Specify	White	\$481.95
6-5002837-670	30 W x 30 D x 29 - 44-1/2 H in	Markerboard	T-Mold	Specify	White	\$481.95
6-5004850-670	30 W x 30 D x 29 - 44-1/2 H in	Markerboard	LockEdge	Specify	White	\$548.95
6-5002844-670	36 W x 36 D x 29 - 44-1/2 H in	Markerboard	T-Mold	Specify	White	\$515.95
6-5004851-670	36 W x 36 D x 29 - 44-1/2 H in	Markerboard	LockEdge	Specify	White	\$548.95
<b>Square with Laminate</b>						
6-5002839-670	24 W x 24 D x 29 - 44-1/2 H in	Laminate	T-Mold	Specify	Specify	\$428.95
6-5002848-670	24 W x 24 D x 29 - 44-1/2 H in	Laminate	LockEdge	Specify	Specify	\$461.95
6-5002836-670	30 W x 30 D x 29 - 44-1/2 H in	Laminate	T-Mold	Specify	Specify	\$461.95
6-5002845-670	30 W x 30 D x 29 - 44-1/2 H in	Laminate	LockEdge	Specify	Specify	\$528.95
6-5002843-670	36 W x 36 D x 29 - 44-1/2 H in	Laminate	T-Mold	Specify	Specify	\$495.95
6-5002833-670	36 W x 36 D x 29 - 44-1/2 H in	Laminate	LockEdge	Specify	Specify	\$528.95
<b>Square with Markerboard</b>						
6-5002827-670	24 W x 24 D x 29 - 44-1/2 H in	Markerboard	T-Mold	Specify	White	\$448.95
6-5004852-670	24 W x 24 D x 29 - 44-1/2 H in	Markerboard	LockEdge	Specify	White	\$481.95
6-5002847-670	30 W x 30 D x 29 - 44-1/2 H in	Markerboard	T-Mold	Specify	White	\$481.95
6-5004853-670	30 W x 30 D x 29 - 44-1/2 H in	Markerboard	LockEdge	Specify	White	\$548.95
6-5002841-670	36 W x 36 D x 29 - 44-1/2 H in	Markerboard	T-Mold	Specify	White	\$515.95
6-5004854-670	36 W x 36 D x 29 - 44-1/2 H in	Markerboard	LockEdge	Specify	White	\$548.95



PRODUCT CERTIFIED FOR LOW CHEMICAL EMISSIONS: UL.COM/IGG UL 2818



Refer to pages 60-61 for color selections.



Stainless Steel Frame Cafe and Bistro Table with Laminate Top



Stainless Steel Frame Cafe and Bistro Table with Markerboard Top

Black Frame Cafe and Bistro Table with Laminate Top



**Classroom Select® Cafe and Bistro Table**

A great addition to any cafeteria or flexible space that encourages interaction. Offered in a 29" standard height or a 42" tall bistro height. Bases are available in stainless steel or black powder coat finish in an X-style or round base. Table top sizes include 30" x 48", 30" x 60", 30" x 72", 36" x 60", and 36" x 72" sizes with your choice of standard laminate top colors. Tops are constructed from 1-1/8" MDF core with a T-Mold edge or LockEdge® for added durability. Backed by a limited lifetime warranty.

**T-Mold Cafe and Bistro Tables**

Top Shape	Product Dimensions	Frame Color	Edge Color	Base Type	Laminate Top			Markerboard Top	
					Item #	Top Color	List Price	Item #	List Price
<b>29" Height</b>									
Rectangle	48 W x 30 D in	Specify	Specify	X-Style	6-5008534-670	Specify	\$742.95	6-5008532-670	\$762.95
Rectangle	48 W x 30 D in	Specify	Specify	Round	6-5008530-670	Specify	\$775.95	6-5008528-670	\$795.95
Rectangle	60 W x 30 D in	Specify	Specify	X-Style	6-5008550-670	Specify	\$762.95	6-5008548-670	\$782.95
Rectangle	60 W x 30 D in	Specify	Specify	Round	6-5008546-670	Specify	\$795.95	6-5008544-670	\$815.95
Rectangle	72 W x 30 D in	Specify	Specify	X-Style	6-5008566-670	Specify	\$775.95	6-5008564-670	\$795.95
Rectangle	72 W x 30 D in	Specify	Specify	Round	6-5008562-670	Specify	\$809.95	6-5008560-670	\$829.95
Rectangle	60 W x 36 D in	Specify	Specify	X-Style	6-5008582-670	Specify	\$842.95	6-5008580-670	\$862.95
Rectangle	60 W x 36 D in	Specify	Specify	Round	6-5008578-670	Specify	\$875.95	6-5008576-670	\$895.95
Rectangle	72 W x 36 D in	Specify	Specify	X-Style	6-5008598-670	Specify	\$869.95	6-5008596-670	\$889.95
Rectangle	72 W x 36 D in	Specify	Specify	Round	6-5008594-670	Specify	\$902.95	6-5008592-670	\$922.95
<b>42" Height</b>									
Rectangle	48 W x 30 D in	Specify	Specify	X-Style	6-5008542-670	Specify	\$775.95	6-5008540-670	\$795.95
Rectangle	48 W x 30 D in	Specify	Specify	Round	6-5008538-670	Specify	\$809.95	6-5008536-670	\$829.95
Rectangle	60 W x 30 D in	Specify	Specify	X-Style	6-5008558-670	Specify	\$795.95	6-5008556-670	\$815.95
Rectangle	60 W x 30 D in	Specify	Specify	Round	6-5008554-670	Specify	\$829.95	6-5008552-670	\$849.95
Rectangle	72 W x 30 D in	Specify	Specify	X-Style	6-5008574-670	Specify	\$809.95	6-5008572-670	\$829.95
Rectangle	72 W x 30 D in	Specify	Specify	Round	6-5008570-670	Specify	\$842.95	6-5008568-670	\$862.95
Rectangle	60 W x 36 D in	Specify	Specify	X-Style	6-5008590-670	Specify	\$875.95	6-5008588-670	\$895.95
Rectangle	60 W x 36 D in	Specify	Specify	Round	6-5008586-670	Specify	\$909.95	6-5008584-670	\$929.95
Rectangle	72 W x 36 D in	Specify	Specify	X-Style	6-5008606-670	Specify	\$902.95	6-5008604-670	\$922.95
Rectangle	72 W x 36 D in	Specify	Specify	Round	6-5008602-670	Specify	\$935.95	6-5008600-670	\$955.95





Refer to pages 60-61 for color selections.



PRODUCT CERTIFIED FOR LOW CHEMICAL EMISSIONS: UL.COM/IGG UL 2818



Black Frame Cafe and Bistro Table with Laminate Top



Stainless Steel Cafe and Bistro Table with Markerboard top



### Classroom Select® Cafe and Bistro Table

A great addition to any cafeteria or flexible space that encourages interaction. Offered in a 29" standard height or a 42" tall bistro height. Bases are available in stainless steel or black powder coat finish in an X-style or round base. Table top sizes include 30" x 48", 30" x 60", 30" x 72", 36" x 60", and 36" x 72" sizes with your choice of standard laminate top colors. Tops are constructed from 1-1/8" MDF core with a T-Mold edge or LockEdge® for added durability. Backed by a limited lifetime warranty.

### LockEdge® Cafe and Bistro Tables

Top Shape	Product Dimensions	Frame Color	Edge Color	Base Type	Laminate Top			Markerboard Top	
					Item #	Top Color	List Price	Item #	List Price
<b>29" Height</b>									
Rectangle	48 W x 30 D in	Specify	Specify	X-Style	6-5008533-670	Specify	\$775.95	6-5008531-670	\$795.95
Rectangle	48 W x 30 D in	Specify	Specify	Round	6-5008529-670	Specify	\$809.95	6-5008527-670	\$829.95
Rectangle	60 W x 30 D in	Specify	Specify	X-Style	6-5008549-670	Specify	\$795.95	6-5008547-670	\$815.95
Rectangle	60 W x 30 D in	Specify	Specify	Round	6-5008545-670	Specify	\$829.95	6-5008543-670	\$849.95
Rectangle	72 W x 30 D in	Specify	Specify	X-Style	6-5008565-670	Specify	\$809.95	6-5008563-670	\$829.95
Rectangle	72 W x 30 D in	Specify	Specify	Round	6-5008561-670	Specify	\$842.95	6-5008559-670	\$862.95
Rectangle	60 W x 36 D in	Specify	Specify	X-Style	6-5008581-670	Specify	\$875.95	6-5008579-670	\$895.95
Rectangle	60 W x 36 D in	Specify	Specify	Round	6-5008577-670	Specify	\$909.95	6-5008575-670	\$929.95
Rectangle	72 W x 36 D in	Specify	Specify	X-Style	6-5008597-670	Specify	\$902.95	6-5008595-670	\$922.95
Rectangle	72 W x 36 D in	Specify	Specify	Round	6-5008593-670	Specify	\$935.95	6-5008591-670	\$955.95
<b>42" Height</b>									
Rectangle	48 W x 30 D in	Specify	Specify	X-Style	6-5008541-670	Specify	\$809.95	6-5008539-670	\$829.95
Rectangle	48 W x 30 D in	Specify	Specify	Round	6-5008537-670	Specify	\$842.95	6-5008535-670	\$862.95
Rectangle	60 W x 30 D in	Specify	Specify	X-Style	6-5008557-670	Specify	\$829.95	6-5008555-670	\$849.95
Rectangle	60 W x 30 D in	Specify	Specify	Round	6-5008553-670	Specify	\$862.95	6-5008551-670	\$882.95
Rectangle	72 W x 30 D in	Specify	Specify	X-Style	6-5008573-670	Specify	\$842.95	6-5008571-670	\$862.95
Rectangle	72 W x 30 D in	Specify	Specify	Round	6-5008569-670	Specify	\$875.95	6-5008567-670	\$895.95
Rectangle	60 W x 36 D in	Specify	Specify	X-Style	6-5008589-670	Specify	\$909.95	6-5008587-670	\$929.95
Rectangle	60 W x 36 D in	Specify	Specify	Round	6-5008585-670	Specify	\$942.95	6-5008583-670	\$962.95
Rectangle	72 W x 36 D in	Specify	Specify	X-Style	6-5008605-670	Specify	\$935.95	6-5008603-670	\$955.95
Rectangle	72 W x 36 D in	Specify	Specify	Round	6-5008601-670	Specify	\$969.95	6-5008599-670	\$989.95



PRODUCT CERTIFIED FOR LOW CHEMICAL EMISSIONS: UL CQM005 UL 2818



Refer to pages 60-61 for color selections.

**Classroom Select® NeoClass® Sled Base Stacking Chair and Bistro Chair**

The Sled Base Stacking Chair and Bistro Chair can be used in a multitude of settings. Choose from a standard 18" seat height or 30" bistro height option. The polypropylene molded seat and back provide optimal comfort and support. A convenient hand hold offers easy movement and stacking. Chrome steel frame is durable and lightweight. Rounded polyethylene glides will protect the floor. The standard sled based stacking chair glide can be used for ganging purposes. To make transporting even easier for the 18" chair only, try the Classroom Select® chair dolly, sold separately. Glides are removable for carpet use. Assembled.

Item #	Seat Height	Seat and Back Color	Frame Color	List Price
6-1597928-670	30 in	Specify	Chrome	\$151.95
6-1597927-670	18 in	Specify	Chrome	\$124.95
Item #	Description			List Price
6-2024418-670	Chair Dolly			\$266.95



**Classroom Select® Cafe and Bistro Table**

A great addition to any cafeteria or flexible space that encourages interaction. Offered in a standard 29" or a 42" tall Bistro height. Choose from a round or square shape in an x-style or round base. Base selections are available in stainless steel or black powdercoat finish. Table top sizes include 24", 30", 34" or 40" diameter sizes with your choice of standard laminate top colors. Tops are constructed from 1-1/8" MDF core with a T-Mold edge or LockEdge® for added durability. Backed by a limited lifetime warranty.



**T-Mold Cafe and Bistro Tables**

Top Shape	Product Dimensions	Frame Color	Edge Color	Base Type	Laminate Top			Markerboard Top	
					Item #	Top Color	List Price	Item #	List Price
<b>29" Height</b>									
Round	24 in	Specify	Specify	X-Style	6-1597953-670	Specify	\$391.95	6-5000852-670	\$411.95
Round	24 in	Specify	Specify	Round	6-1597954-670	Specify	\$424.95	6-5000851-670	\$444.95
Round	30 in	Specify	Specify	X-Style	6-1597949-670	Specify	\$458.95	6-5000883-670	\$478.95
Round	30 in	Specify	Specify	Round	6-1597950-670	Specify	\$491.95	6-5000882-670	\$511.95
Round	34 in	Specify	Specify	X-Style	6-1597945-670	Specify	\$491.95	6-5000901-670	\$511.95
Round	34 in	Specify	Specify	Round	6-1597946-670	Specify	\$524.95	6-5000900-670	\$544.95
Round	40 in	Specify	Specify	X-Style	6-5002402-670	Specify	\$524.95	6-5002418-670	\$544.95
Round	40 in	Specify	Specify	Round	6-5002409-670	Specify	\$558.95	6-5002412-670	\$578.95
Square	24 in	Specify	Specify	X-Style	6-1597955-670	Specify	\$391.95	6-5000856-670	\$411.95
Square	24 in	Specify	Specify	Round	6-1597956-670	Specify	\$424.95	6-5000855-670	\$444.95
Square	30 in	Specify	Specify	X-Style	6-1597951-670	Specify	\$458.95	6-5000893-670	\$478.95
Square	30 in	Specify	Specify	Round	6-1597952-670	Specify	\$491.95	6-5000892-670	\$511.95
Square	34 in	Specify	Specify	X-Style	6-1597947-670	Specify	\$491.95	6-5000905-670	\$511.95
Square	34 in	Specify	Specify	Round	6-1597948-670	Specify	\$524.95	6-5000904-670	\$544.95
Square	40 in	Specify	Specify	X-Style	6-5003292-670	Specify	\$524.95	6-5003291-670	\$544.95
Square	40 in	Specify	Specify	Round	6-5002423-670	Specify	\$558.95	6-5002413-670	\$578.95
<b>42" Height</b>									
Round	24 in	Specify	Specify	X-Style	6-1597941-670	Specify	\$424.95	6-5000854-670	\$444.95
Round	24 in	Specify	Specify	Round	6-1597942-670	Specify	\$458.95	6-5000853-670	\$478.95
Round	30 in	Specify	Specify	X-Style	6-1597937-670	Specify	\$491.95	6-5000884-670	\$511.95
Round	30 in	Specify	Specify	Round	6-1597938-670	Specify	\$524.95	6-5000885-670	\$544.95
Round	34 in	Specify	Specify	X-Style	6-1597933-670	Specify	\$524.95	6-5000903-670	\$544.95
Round	34 in	Specify	Specify	Round	6-1597934-670	Specify	\$558.95	6-5000902-670	\$578.95
Round	40 in	Specify	Specify	X-Style	6-5003290-670	Specify	\$558.95	6-5003289-670	\$578.95
Round	40 in	Specify	Specify	Round	6-5002406-670	Specify	\$591.95	6-5002426-670	\$611.95
Square	24 in	Specify	Specify	X-Style	6-1597943-670	Specify	\$424.95	6-5000858-670	\$444.95
Square	24 in	Specify	Specify	Round	6-1597944-670	Specify	\$458.95	6-5000857-670	\$478.95
Square	30 in	Specify	Specify	X-Style	6-1597939-670	Specify	\$491.95	6-5000895-670	\$511.95
Square	30 in	Specify	Specify	Round	6-1597940-670	Specify	\$524.95	6-5000894-670	\$544.95
Square	34 in	Specify	Specify	X-Style	6-1597935-670	Specify	\$524.95	6-5000907-670	\$544.95
Square	34 in	Specify	Specify	Round	6-1597936-670	Specify	\$558.95	6-5000906-670	\$578.95
Square	40 in	Specify	Specify	X-Style	6-5002411-670	Specify	\$558.95	6-5002415-670	\$578.95
Square	40 in	Specify	Specify	Round	6-5002428-670	Specify	\$591.95	6-5002419-670	\$611.95

**PLEASE SPECIFY COLOR CHOICE**  
Refer to pages 60-61 for color selections.



**Classroom Select® NeoClass® Bistro Stool**

The Classroom Select® NeoClass® Bistro Stool offers a waterfall seat edge and a contoured back with an opening at the top and bottom to provide ergonomic comfort and boost airflow. Available in an A shell size as well as the wider, more accommodating A+ shell size. Offered in 24" and 30" seat heights and features a foot rest for comfortable seating positions. Frame is made of 1" diameter 16-gauge steel and is available in chrome, black powdercoat, and titanium powdercoat. Nylon glides. Assembled.

Item #	Seat Height	Seat and Back Color	Frame Color	List Price
<b>A+ Shell</b>				
6-5002985-670	30 in	Specify	Chrome	\$184.95
6-5002987-670	30 in	Specify	Specify	\$178.95
6-5003607-670	24 in	Specify	Chrome	\$178.95
6-5003606-670	24 in	Specify	Specify	\$171.95
<b>A Shell</b>				
6-5002986-670	30 in	Specify	Chrome	\$178.95
6-5002988-670	30 in	Specify	Specify	\$171.95
6-5003605-670	24 in	Specify	Chrome	\$171.95
6-5003604-670	24 in	Specify	Specify	\$164.95



Chrome Frame

Black Frame

Titanium Frame



**LockEdge Cafe and Bistro Tables**

Top Shape	Product Dimensions	Frame Color	Edge Color	Base Type	Laminate Top			Markerboard Top	
					Item #	Top Color	List Price	Item #	List Price
<b>29" Height</b>									
Round	24 in	Specify	Specify	X-Style	6-1599200-670	Specify	\$458.95	6-5000860-670	\$478.95
Round	24 in	Specify	Specify	Round	6-1599201-670	Specify	\$491.95	6-5000859-670	\$511.95
Round	30 in	Specify	Specify	X-Style	6-1599196-670	Specify	\$524.95	6-5000889-670	\$544.95
Round	30 in	Specify	Specify	Round	6-1599197-670	Specify	\$558.95	6-5000886-670	\$578.95
Round	34 in	Specify	Specify	X-Style	6-1599192-670	Specify	\$558.95	6-5000909-670	\$578.95
Round	34 in	Specify	Specify	Round	6-1599193-670	Specify	\$591.95	6-5000908-670	\$611.95
Round	40 in	Specify	Specify	X-Style	6-5002429-670	Specify	\$591.95	6-5002404-670	\$611.95
Round	40 in	Specify	Specify	Round	6-5002410-670	Specify	\$624.95	6-5002403-670	\$644.95
Square	24 in	Specify	Specify	X-Style	6-1599202-670	Specify	\$458.95	6-5000864-670	\$478.95
Square	24 in	Specify	Specify	Round	6-1599203-670	Specify	\$491.95	6-5000863-670	\$511.95
Square	30 in	Specify	Specify	X-Style	6-1599198-670	Specify	\$524.95	6-5000897-670	\$544.95
Square	30 in	Specify	Specify	Round	6-1599199-670	Specify	\$558.95	6-5000896-670	\$578.95
Square	34 in	Specify	Specify	X-Style	6-1599194-670	Specify	\$558.95	6-5000913-670	\$578.95
Square	34 in	Specify	Specify	Round	6-1599195-670	Specify	\$591.95	6-5000912-670	\$611.95
Square	40 in	Specify	Specify	X-Style	6-5002422-670	Specify	\$591.95	6-5002421-670	\$611.95
Square	40 in	Specify	Specify	Round	6-5002431-670	Specify	\$624.95	6-5002401-670	\$644.95
<b>42" Height</b>									
Round	24 in	Specify	Specify	X-Style	6-1599187-670	Specify	\$491.95	6-5000862-670	\$511.95
Round	24 in	Specify	Specify	Round	6-1599188-670	Specify	\$524.95	6-5000861-670	\$544.95
Round	30 in	Specify	Specify	X-Style	6-1599184-670	Specify	\$558.95	6-5000891-670	\$578.95
Round	30 in	Specify	Specify	Round	6-1598671-670	Specify	\$591.95	6-5000890-670	\$611.95
Round	34 in	Specify	Specify	X-Style	6-1599180-670	Specify	\$591.95	6-5000911-670	\$611.95
Round	34 in	Specify	Specify	Round	6-1599181-670	Specify	\$624.95	6-5000910-670	\$644.95
Round	40 in	Specify	Specify	X-Style	6-5002430-670	Specify	\$624.95	6-5002432-670	\$644.95
Round	40 in	Specify	Specify	Round	6-5002416-670	Specify	\$658.95	6-5002417-670	\$678.95
Square	24 in	Specify	Specify	X-Style	6-1599190-670	Specify	\$491.95	6-5000881-670	\$511.95
Square	24 in	Specify	Specify	Round	6-1599191-670	Specify	\$524.95	6-5000873-670	\$544.95
Square	30 in	Specify	Specify	X-Style	6-1599185-670	Specify	\$558.95	6-5000899-670	\$578.95
Square	30 in	Specify	Specify	Round	6-1599186-670	Specify	\$591.95	6-5000898-670	\$611.95
Square	34 in	Specify	Specify	X-Style	6-1599182-670	Specify	\$591.95	6-5000915-670	\$611.95
Square	34 in	Specify	Specify	Round	6-1599183-670	Specify	\$624.95	6-5000914-670	\$644.95
Square	40 in	Specify	Specify	X-Style	6-5002408-670	Specify	\$624.95	6-5002414-670	\$644.95
Square	40 in	Specify	Specify	Round	6-5002420-670	Specify	\$658.95	6-5002427-670	\$678.95





PRODUCT CERTIFIED FOR LOW CHEMICAL EMISSIONS: UL-COEWG2 UL 2818



**CHILDCRAFT**  
A School Specialty Exclusive

**Childcraft® Portable Handwashing Sink**

Portable sink is equipped with two, 5-gallon vented water tanks for clean and waste water. No plumbing necessary, just plug it in. Features 5" deep stainless steel sink with metered faucet and laminate countertop. Soap dispenser holds up to 16 oz. of liquid soap. Heavy-duty locking casters. Ships assembled.

Item #	Description	Product Dimensions	List Price
6-2039501-670	Portable Sink	30 W x 24 D x 26 H in	\$3,391.95

**CLASSROOM SELECT**

**Classroom Select® Utility Cart**

Durable high density thermoplastic cart has two or three shelves 4 1/4" deep with weight capacity of 250 lbs. per shelf. Includes 4 casters - 2 swivel, 2 fixed. Some assembly required.



Item #	Description	Product Dimensions	Capacity	Color	List Price
6-678771-670	Small Cart - 2 Shelf	17 W x 31 D x 33 H in	500 lb	Gray	\$297.95
6-678772-670	Large Cart - 2 Shelf	25-1/2 W x 37-1/2 D x 33 H in	500 lb	Gray	\$372.95
9-2091193-670	Small Cart - 3 Shelf	17 W x 31 D x 33 H in	750 lb	Gray	\$347.95
9-2091192-670	Large Cart - 3 Shelf	25-1/2 W x 37-1/2 D x 33 H in	750 lb	Gray	\$449.95



**nex.terra**  
CONFIGURED SOLUTIONS™

**Nex-Terra Waste Receptacles**

Nex-Terra Receptacles are constructed from 97% Type 2 HDPE, the purest form of recycled plastic available in the industry today. Each receptacle station is totally customizable with options for colors, restricted openings, custom logos and decals that match your needs. Liner included. Please contact your local School Specialty Rep for customizable options.

Item #	Description	Capacity	Product Dimensions	List Price
6-2104914-670	Single - Recycle Receptacle	32 Gal	21 W x 20 D x 43 H in	\$2,955.95
6-2104912-670	Single - Waste Receptacle	32 Gal	21 W x 20 D x 43 H in	\$2,955.95
6-2104911-670	Double - Waste & Recycle Recp	32 Gal	39 W x 21 D x 43 H in	\$4,989.95
6-2104910-670	Triple - Recycle-Waste-Compost	32 Gal	58 W x 20 D x 43 H in	\$7,052.95



# portable chairs & tables



A



B



C



D

## National Public Seating® Heavy Duty Folding Tables

These heavy duty blow-molded plastic tables are suitable for indoor or outdoor use. These are lightweight, weather-resistant and highly durable. Their lightly textured design keeps them scratch-resistant yet still enables a surface smooth enough for writing. ANSI/BIFMA approved.

Item #	Product Dimensions	Color	Top Shape	List Price
A 6-2051289-670	24 W x 48 D x 29-1/2 H in	Speckled Gray	Rectangle	\$133.95
A 6-676049-670	60 W x 30 D x 29-1/2 H in	Speckled Gray	Rectangle	\$156.95
A 6-676050-670	72 W x 30 D x 29-1/2 H in	Speckled Gray	Rectangle	\$183.95
A 6-676051-670	96 W x 30 D x 29-1/2 H in	Speckled Gray	Rectangle	\$265.95
B 6-2103386-670	72 W x 30 D x 29-1/2 H in	Charcoal	Rectangle	\$183.95
C 6-1333614-670	48 W x 48 D x 29-1/2 H in	Speckled Gray	Round	\$208.95
C 6-676052-670	60 W x 60 D x 29-1/2 H in	Speckled Gray	Round	\$325.95
C 6-1333615-670	71 W x 71 D x 29-1/2 H in	Speckled Gray	Round	\$459.95
D 6-679491-670	60 W x 18 D x 29-1/2 H in	Speckled Gray	Seminar	\$174.95
D 6-679492-670	72 W x 18 D x 29-1/2 H in	Speckled Gray	Seminar	\$181.95
D 6-679493-670	96 W x 18 D x 29-1/2 H in	Speckled Gray	Seminar	\$229.95
E 6-2027737-670	72 W x 30 D x 29-1/2 H in	Speckled Gray	Rectangle	\$221.95



Folds in Half



E

## National Public Seating® Table Dollies and Caddies

These are perfect for use with folding tables.

Item #	Description	Product Dimensions	List Price
6-678535-670	Table Caddy Round 48 & 60 Inch	27-3/4 Wx47-1/2 Dx31-1/4 H in	\$540.95
6-1333616-670	Table Caddy Round 71 Inches	28 W x 48 D x 40 H in	\$640.95
6-678536-670	Table Caddy 72 Inches Max	31 W x 74 D x 43 H in	\$645.95
6-678537-670	Table Caddy 96 Inches Max	31 W x 90-1/4 D x 43 H in	\$765.95
9-1584476-670	Table Dolly Fits 12 Rnd/Rect	27-3/4 Wx47-1/2 Dx31-1/4 H in	\$609.95



table caddy round



table caddy rectangle



**Correll High Pressure Laminate Table**

Heavy-duty 3/4" high pressure laminate top with backer sheet. Different size options make this table a perfect fit for multiple uses. Fixed height of 29". Please specify top color choice when ordering. Frame and T-Mold colors are pre-determined by factory. See color chart below. Quickship is available in Walnut with limited quantities. **⚠️WARNING: This product can expose you to chemicals including Lead and Formaldehyde, which are known to the State of California to cause cancer and/or birth defects or other reproductive harm. For more information go to www.P65Warnings.ca.gov.**

Item #	Product Dimensions	Top Color	List Price
<b>29 in Fixed Height</b>			
6-1362509-670	72 W x 18 D x 29 H in	Specify	\$476.95
6-1362510-670	48 W x 24 D x 29 H in	Specify	\$456.95
6-1362512-670	60 W x 30 D x 29 H in	Specify	\$470.95
6-1362514-670	72 W x 30 D x 29 H in	Specify	\$523.95
6-1362516-670	96 W x 30 D x 29 H in	Specify	\$617.95
6-1362521-670	60 Dia x 29 H in	Specify	\$830.95
<b>22-32 Adj Height</b>			
6-1428455-670	48 W x 24 D x 22 - 32 H in	Specify	\$553.95
6-1428456-670	60 W x 30 D x 22 - 32 H in	Specify	\$571.95
6-1428457-670	72 W x 30 D x 22 - 32 H in	Specify	\$622.95
6-1428458-670	96 W x 30 D x 22 - 32 H in	Specify	\$718.95
<b>29 in Fixed Height</b>			
6-1428477-670	72 W x 18 D x 29 H in	Specify	\$476.95
6-1428478-670	48 W x 24 D x 29 H in	Specify	\$499.95
6-1428479-670	60 W x 30 D x 29 H in	Specify	\$517.95
6-1428480-670	72 W x 30 D x 29 H in	Specify	\$575.95
6-1428481-670	96 W x 30 D x 29 H in	Specify	\$679.95
6-1428482-670	60 Dia x 29 H in	Specify	\$913.95
<b>22-32 Adj Height</b>			
6-1428459-670	48 W x 24 D x 22 - 32 H in	Specify	\$605.95
6-1428460-670	60 W x 30 D x 22 - 32 H in	Specify	\$628.95
6-1428461-670	72 W x 30 D x 22 - 32 H in	Specify	\$685.95
6-1428462-670	96 W x 30 D x 22 - 32 H in	Specify	\$790.95

**Correll High Pressure Laminate and Melamine Table Colors**

TOP	WALNUT	MEDIUM OAK	GRAY GRANITE	BLACK GRANITE
T-MOLD	BLACK	BROWN	GRAY	BLACK
FRAME	BROWN	BROWN	GRAY	BLACK



**National Public Seating® Max Seating Folding Tables**

The NPS Max Seating Folding Table is the superior choice for a lightweight, industrial-grade wooden folding table. With its unitized 1 1/4 Inch squared legs installed to the far corners of the tabletop and an Auto-Engage locking mechanism, these tables are engineered for easy setup, ultimate durability, and maximum seating space in an elegant setting. The Max Seating folding tables provide a perfect solution for banquet, seminar and dining hall settings. Offering ultimate seating space and rock-solid leg stability, these tables are the perfect choice for your folding table needs.

Item #	Product Dimensions	Top Type	Top Color	Frame Color	List Price
6-5009628-670	18"W X 72"D X 19"H	High Pressure Laminate	Specify	Black	\$629.95
6-5009629-670	18"W X 96"D X 19"H	High Pressure Laminate	Specify	Black	\$699.95
6-5009630-670	30"W X 72"D X 19"H	High Pressure Laminate	Specify	Black	\$749.95



**Correll Melamine Economy Folding Table**

Different size options make this table a perfect fit for multiple uses. Choose from a fixed height of 29" or an adjustable height range of 22" to 32". Please specify color choice when ordering.

**⚠️WARNING: This product can expose you to chemicals including Lead and Formaldehyde, which are known to the State of California to cause cancer and/or birth defects or other reproductive harm. For more information go to www.P65Warnings.ca.gov.**

Item #	Product Dimensions	Top Color	List Price
<b>29 in Fixed Height</b>			
6-1362511-670	60 W x 30 D x 29 H in	Specify	\$303.95
6-1362513-670	72 W x 30 D x 29 H in	Specify	\$320.95
6-1362515-670	96 W x 30 D x 29 H in	Specify	\$378.95
6-1362517-670	72 W x 36 D x 29 H in	Specify	\$378.95
6-1362518-670	96 W x 36 D x 29 H in	Specify	\$424.95
<b>Round</b>			
6-1362520-670	60 Dia x 29 H in	Specify	\$607.95
<b>22-32 Adj Height</b>			
6-1428463-670	48 W x 24 D x 22 - 32 H in	Specify	\$400.95
6-1428464-670	60 W x 30 D x 22 - 32 H in	Specify	\$400.95
6-1428465-670	72 W x 30 D x 22 - 32 H in	Specify	\$419.95
6-1428466-670	96 W x 30 D x 22 - 32 H in	Specify	\$472.95

**Correll High Intensity Colors**

TOP	GREEN	WHITE	YELLOW	RED	BLUE
T-MOLD	BLACK	BLACK	BLACK	BLACK	BLACK
FRAME	BLACK	BLACK	BLACK	BLACK	BLACK







### Correll Commercial Folding and Activity Tables

These Plastic Folding and Activity Tables are lightweight and easy to handle. Tops are water proof, scratch, stain and impact resistant. Surface is lightly textured, yet smooth enough for writing. All tables come with Black frames, except Mocha Granite top color comes with a Brown frame. Includes a 5 Year Warranty.

**⚠ WARNING: This product can expose you to chemicals including Lead and Formaldehyde, which are known to the State of California to cause cancer and/or birth defects or other reproductive harm. For more information go to [www.P65Warnings.ca.gov](http://www.P65Warnings.ca.gov).**

Item #	Product Dimensions	Leg Height	Color	Top Shape	List Price
<b>Adjustable Height Folding Tables</b>					
5-1363504-670	48 W x 24 D x 17 - 27 H in	17 - 27 in	Specify	Rectangle	\$475.95
5-1363503-670	60 W x 30 D x 17 - 27 H in	17 - 27 in	Specify	Rectangle	\$572.95
6-1363502-670	72 W x 30 D x 17 - 27 H in	17 - 27 in	Specify	Rectangle	\$600.95

Item #	Product Dimensions	Leg Height	Color	Top Shape	List Price
<b>Commercial Duty Folding Tables</b>					
6-1428468-670	48 W x 24 D x 29 H in	29 in	Specify	Rectangle	\$335.95
6-1428469-670	60 W x 30 D x 29 H in	29 in	Specify	Rectangle	\$417.95
6-1428467-670	72 W x 18 D x 29 H in	29 in	Specify	Rectangle	\$417.95
6-1428470-670	72 W x 30 D x 29 H in	29 in	Specify	Rectangle	\$444.95
6-1428471-670	96 W x 30 D x 29 H in	29 in	Specify	Rectangle	\$585.95
6-1428472-670	60 W x 60 D x 29 H in	29 in	Specify	Round	\$801.95
6-1428473-670	48 W x 24 D x 22 - 32 H in	22 - 32 in	Specify	Rectangle	\$431.95
6-1428474-670	60 W x 30 D x 22 - 32 H in	22 - 32 in	Specify	Rectangle	\$518.95
6-1428475-670	72 W x 30 D x 22 - 32 H in	22 - 32 in	Specify	Rectangle	\$546.95

Item #	Top Shape	Product Dimensions	Product Height	Top Color	List Price
<b>Correll Bright Color Activity Tables (not available in Mocha) Non-Folding</b>					
6-336865-670	Rectangle	48 W x 24 D in	19 - 29 in	Specify	\$418.95
6-336866-670	Rectangle	60 W x 30 D in	19 - 29 in	Specify	\$491.95
6-336867-670	Rectangle	72 W x 30 D in	19 - 29 in	Specify	\$552.95
6-336868-670	Kidney	72 W x 48 D in	19 - 29 in	Specify	\$777.95

#### Correll Blow Molded Table Colors



	RED	BLUE	YELLOW	GREEN	GRAY GRANITE	MOCHA
TOP						
FRAME	BLACK	BLACK	BLACK	BLACK	BLACK	BROWN

Strong Steel Frame for Commercial Use

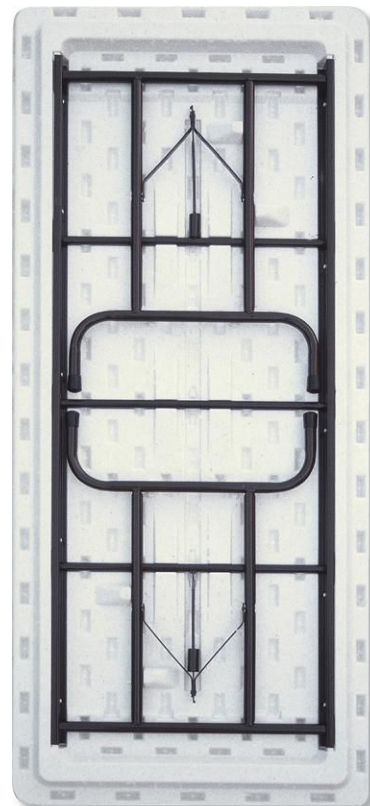

**QUICKSHIP**  
Items ship within 24 hrs, 48 hrs, 1 or 2 weeks as indicated when the factory distribution center receives the order.

Items ship **Freight** or **Parcel**

See Shipping & Handling terms for details.



**National Public Seating® 1400 Series Airflex Plastic Folding Chair**

Distinct AirFlex design, using air technology, contours to each individual making for the perfect balance of comfort and strength. Built on an 18 gauge steel frame with 11 gauge seat braces along with ultra-durable industrial grade 3.8mm polypropylene seat and back allows for a 1000 lbs. weight capacity making the Airflex virtually indestructible. Oversized 18 inch seat pad and ventilated design provides extreme comfort for all day use. It's the ideal chair for any indoor or outdoor event. Glide & leg plugs allow for stacking & nesting.

Item #	Seat Height	Seat Color	Quantity	List Price
5-2051297-670	18 in	Black	Case of 4	\$297.95
5-2096275-670	18 in	White	Case of 4	\$297.95
<b>1400 Series Dolly - Capacity 54 Chairs</b>				
6-2027736-670			Each	\$832.95



**National Public Seating® 600 Series Lightweight Folding Chair**

This high quality blow-molded resin folding chair features an ergonomically designed 18 inch seat and back making it extremely comfortable as it softly contours to your body. The blow-molded plastic is fade and stain resistant. A textured powder coated frame made from heavy duty 1 1/4 inch round tubing offers superior strength. Our durable plastic construction is ideal for indoor or outdoor use and yet is lightweight enough for easy handling. ANSI BIFMA approved.

Item #	Seat Color	Frame Color	Quantity	List Price
5-2051303-670	Black	Black	Case of 4	\$314.95
5-2051304-670	Blue	Black	Case of 4	\$314.95
5-2051315-670	Red	Black	Case of 4	\$314.95
5-2051312-670	Charcoal	Silver	Case of 4	\$314.95
5-2051299-670	Speckled Gray	Grey	Case of 4	\$314.95

**National Public Seating® 1100 Series Deluxe Polyfold Fan Back Chairs**

Oversized fan back chair with plastic seats. Frame is 7/8" round tubing, supported with triple double riveted arch braces for leg stability and double hinged linking front to rear legs for superior strength.

Item #	Seat Height	Seat Color	Quantity	List Price
5-2051327-670	17-3/4 in	Black	Case of 4	\$258.95
5-2051324-670	17-3/4 in	Dark Blue	Case of 4	\$258.95
<b>1100 Series Dolly - Capacity 26 Chairs</b>				
5-679325-670			Each	\$374.95





**National Public Seating® 1300 Series Premium Upholstered Vinyl Folding Chair**

These upholstered folding chairs feature a 1 1/4" padding on the seat covered with heavy duty vinyl. The double hinge on each side of the chair prevent the legs from buckling. Heavy 18 gauge durable steel frame. "V" tip stability plugs and double riveted "U" Shaped cross braces for added stability, with the addition of a second back leg cross brace to give it triple the strength of a standard chair.

Item #	Seat Height	Seat Color	Quantity	List Price
5-2051336-670	17-3/4 in	Caviar Black	Case of 4	\$265.95
5-2051301-670	17-3/4 in	Dark Midnight Blue	Case of 4	\$265.95
5-2051298-670	17-3/4 in	Warm Gray	Case of 4	\$265.95
5-2051291-670	17-3/4 in	French Beige	Case of 4	\$265.95

**NPS 1200 & 1300 Series Vinyl/Frame Colors**



A



B



C



D



**A National Public Seating® 1200 Series Premium Vinyl Folding Chair**

These upholstered folding chairs feature a 1 1/4" padding on the seat covered with heavy duty vinyl. The double hinge on each side of chair prevent the legs from buckling. Heavy 18 gauge durable steel frame. Includes "V" tip stability plugs and double riveted "U" Shaped cross braces for added stability.

Item #	Seat Height	Seat Color	Quantity	List Price
5-2051295-670	17-3/4 in	Caviar Black	Case of 4	\$227.95
5-2051309-670	17-3/4 in	French Beige	Case of 4	\$227.95
5-2051296-670	17-3/4 in	Honey Brown	Case of 4	\$227.95
5-2051300-670	17-3/4 in	Dark Midnight Blue	Case of 4	\$227.95
5-2051307-670	17-3/4 in	Warm Gray	Case of 4	\$227.95

**B National Public Seating® 2200 Series Premium Fabric Folding Chair**

These fabric upholstered folding chairs feature a double contoured back, double hinges, double riveted "U" Shaped cross braces, non-marring glides, and "V" tip stability caps. The 1 1/4" upholstery covers the entire seat and back. The seats and backs are firmly riveted to the chair.

Item #	Seat Height	Seat Color	Quantity	List Price
5-2051317-670	17-3/4 in	Cafe Beige	Case of 4	\$251.95
5-2051290-670	17-3/4 in	Black	Case of 4	\$251.95
5-2051320-670	17-3/4 in	Russet Walnut	Case of 4	\$251.95
5-2051328-670	17-3/4 in	Imperial Blue	Case of 4	\$251.95
5-2051316-670	17-3/4 in	Majestic Cabernet	Case of 4	\$251.95
5-2051302-670	17-3/4 in	Greystone	Case of 4	\$251.95
5-2051318-670	17-3/4 in	Imperial Blue	Case of 4	\$251.95

**C National Public Seating® 2300 Series Premium Fabric Folding Chair**

The 2300 Series has the identical quality features of the 2200 Series, with the addition of a second cross brace on the back leg to give it triple the strength of a standard chair.

Item #	Seat Height	Seat Color	Quantity	List Price
5-2051321-670	17-3/4 in	Midnight Black	Case of 4	\$275.95
5-2051313-670	17-3/4 in	Cafe Beige	Case of 4	\$275.95
5-2051329-670	17-3/4 in	Char-Blue	Case of 4	\$275.95
5-2051335-670	17-3/4 in	Greystone	Case of 4	\$275.95
5-2051333-670	17-3/4 in	Majestic Cabernet	Case of 4	\$275.95

**NPS 2200 & 2300 Fabric/Frame Colors**



**D National Public Seating® 3200 Series Padded Folding Chairs**

Features include a 2" upholstered box seat on a masonite board, padded backs are fully covered in fabric on both sides, double hinges on each leg, two double-riveted cross braces, color coordinated stability plugs and glides, designer fabrics and textured enamel frames.

Item #	Seat Height	Seat Color	Quantity	List Price
5-2051339-670	18-1/2 in	Charcoal	Case of 2	\$159.95
5-2051332-670	18-1/2 in	Antique Gold	Case of 2	\$159.95
5-2051326-670	18-1/2 in	Burgundy	Case of 2	\$159.95
5-2051323-670	18-1/2 in	Regal Blue	Case of 2	\$159.95
5-2051334-670	18-1/2 in	Black	Case of 2	\$159.95
5-2051322-670	18-1/2 in	Beige	Case of 2	\$159.95

**NPS 3200 Fabric/Frame Colors**







**National Public Seating®  
800 Series Premium Lightweight Folding Chair**

A folding chair that incorporates the strengths of a metal folding chair with the benefits of a plastic folding chair. The plastic seat and back are made of molded and contoured, polypropylene plastic with special edging to enable stacking up to 80" high. Plastic seat and backs won't fade or rust and aren't cold to the touch like steel chairs! Features a powdercoated steel frame.

Item #	Seat Height	Seat Color	Frame Color	Quantity	List Price
5-2051330-670	18 in	Black	Black	Case of 4	\$189.95
5-2051337-670	18 in	Burgundy	Black	Case of 4	\$189.95
5-2051325-670	18 in	Charcoal	Black	Case of 4	\$189.95
5-2051331-670	18 in	Blue	Grey	Case of 4	\$189.95
5-2051310-670	18 in	Grey	Grey	Case of 4	\$189.95
5-2051305-670	18 in	White	White	Case of 4	\$189.95
<b>800 Series Dolly - Capacity 36</b>					
5-672418-670			Brown	Each	\$319.95

**National Public Seating® Hanging Chair Caddy**

This Double-Tiered Hanging Chair Caddy holds up to 84 steel or plastic folding chairs with this durable, tubular steel, easy-to-assemble unit. Manufactured from 14 and 16 gauge steel tubing. Extension bar kit required for NPS 600, 1100, and 3200 series chairs.

Item #	Frame Color	Capacity	List Price
6-661637-670	Dark Brown	84 Chairs	\$743.95
<b>Extender Bar Kit</b>			
5-679328-670	Dark Brown	-	\$63.95



**National Public Seating® Folding Chair Dolly**

Solid steel powder coated construction provides a stable caddy for storing and transporting. Additional handle bar sockets allow secure placement, and easy handling. An under stage conversion kit is also available and requires 26"H for clearance.

Item #	Frame Color	Capacity	List Price
6-677300-670	Brown	35 Chairs	\$493.95
6-677299-670	Brown	50 Chairs	\$609.95
<b>Under Stage Kit</b>			
6-679327-670	-	-	\$120.95



Beige



**National Public Seating® 50 Series Standard All-Steel Folding Chair**

The Standard All-Steel folding chair features a 19 gauge 7/8" round tubular frame with 2 1/2" frame strengthener on each side of the seat; two 19 gauge 5/8" U-shaped double riveted cross braces. The back features a single contour with curled safety edges and is electro magnetically welded to the frame. Color coordinated V-Tip Plugs for added stability.

Item #	Seat Height	Seat Color	Quantity	List Price
6-2051434-670	16-3/4 in	Beige	Case of 4	\$184.95
6-2051436-670	16-3/4 in	Black	Case of 4	\$184.95
6-2051435-670	16-3/4 in	Grey	Case of 4	\$184.95



Char-Blue

**National Public Seating® 200 Series Premium All-Steel Folding Chairs**

Our premium all-steel institutional-grade folding chair features a heavy-duty power-coated 18-gauge tubular frame with a 2 1/4 inch frame strengthener on each side of the seat. Double hinges on each side for added stability and durability. Color-coordinated V-tip stability plugs to provide added reinforcement and prevent floor damage.

Item #	Seat Height	Seat Color	Quantity	List Price
5-2051251-670	17-1/4 in	Char-Blue	Case of 4	\$185.95
6-2051431-670	17-1/4 in	Beige	Case of 4	\$185.95
6-2051429-670	17-1/4 in	Grey	Case of 4	\$185.95
6-2051433-670	17-1/4 in	Brown	Case of 4	\$185.95
6-2051430-670	17-1/4 in	Black	Case of 4	\$185.95
6-2051432-670	17-1/4 in	Red	Case of 4	\$185.95



Grey

**National Public Seating® 300 Series Steel Folding Chair**

This fully featured chair has three double riveted "U" braces connecting the legs for unparalleled strength and stability. One connecting the front legs and two on the rear legs. Heavy 18 gauge steel and double hinges with a unique design for comfort make this a top of the line choice.

Item #	Seat Height	Seat Color	Quantity	List Price
5-2051294-670	17-1/4 in	Beige	Case of 4	\$212.95
5-2051308-670	17-1/4 in	Black	Case of 4	\$212.95
5-2051293-670	17-1/4 in	Brown	Case of 4	\$212.95
5-2051311-670	17-1/4 in	Char-Blue	Case of 4	\$212.95
5-2051292-670	17-1/4 in	Grey	Case of 4	\$212.95

**NPS Folding Chair Colors**

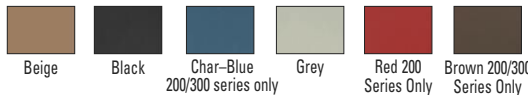

**National Public Seating® 5200 Series Steel Folding Chair with Tablet Arm ( Right and Left )**

The popular 200 Series folding chair with an added tablet arm. Fold the chair and the tablet arm folds up against the chair. Tablet is gray nebula laminate on an MDF core with black edging. Tablet arm measures 13.5"W x 22"D. Folded depth 4".

Item #	Seat Height	Seat Color	Quantity	List Price
<b>Left Side Tablet Arm</b>				
5-2051314-670	17-1/4 in	Black	Case of 2	\$199.95
<b>Right Side Tablet Arm</b>				
5-2051338-670	17-1/4 in	Black	Case of 2	\$199.95

**NPS 5200 Series Colors**



QUICKSHIP Items ship within 24 hrs, 48 hrs, 1 or 2 weeks as indicated when the factory distribution center receives the order.

Items ship Freight or Parcel

See Shipping & Handling terms for details.

**National  
Public  
Seating**



TEN YEAR  
**10**  
WARRANTY



**National Public Seating® 9100 Series Value Stacker**

Economical low back stacker chair built on a sturdy 19 gauge 3/4" frame with extra rear "H" brace. Heavy grade vinyl covers a 1/2" high density seat pad. Built-in rear handhold and hooked on bungee cord secures the chairs for added safety. Perfect for teacher's lounge, cafe, offices and meeting rooms.

Item #	Seat Height	Seat Color	Frame Color	List Price
5-1364320-670	18 in	Specify	Black	\$71.95
<b>Chair Dolly - Capacity 10</b>				
5-632845-670			Brown	\$303.95

**National Public Seating® 9200 Series Stack Chairs**

The Dome-Back stack chair is durable and features a strong 18-gauge steel frame plus an under-seat H-shaped brace for extra support. A spacious 2" thick foam cushioned waterfall seat coupled with a plywood core seat and back assures you a comfortable chair. The back has a convenient handhold for ease of movement. The stacking bars and 12 plastic stack bumpers enable the chairs to stack securely without damaging the attractive powder-coated frame finish. Choose from fabric or vinyl upholstery. ANSI/BFMA approved. Ships fully assembled.



Item #	Seat Height	Seat Color	Frame Color	List Price
<b>Vinyl/Fabric</b>				
5-1363778-670	19 in	Specify	Specify	\$74.95
<b>Vinyl</b>				
6-1336163-670	19 in	Midnight Blue	Silvervein	\$74.95
6-1336162-670	19 in	Midnight Blue	Sandtex Black	\$74.95
6-1336165-670	19 in	Black	Sandtex Black	\$74.95
<b>Fabric</b>				
6-1336157-670	19 in	Midnight Blue	Sandtex Black	\$74.95

PLEASE SPECIFY COLOR CHOICE

**NPS 9100 Series Colors**



**NPS 9200 Series Fabric Colors**

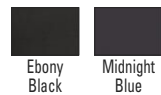

**NPS 9200 Series Pattern Colors**

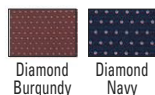

**NPS 9200 Series Frame Colors**



**NPS 9200 Series Vinyl Colors**







PRODUCT CERTIFIED FOR LOW CHEMICAL EMISSIONS: UL.COM/IGG UL 2818



### Classroom Select® NeoClass® Sled Base Stacking Chair and Bistro Chair

The Sled Base Stacking Chair and Bistro Chair can be used in a multitude of settings. Choose from a standard 18" seat height or 30" bistro height option. The polypropylene molded seat and back provide optimal comfort and support. A convenient hand hold offers easy movement and stacking. Chrome steel frame is durable and lightweight. Rounded polyethylene glides will protect the floor. The standard sled based stacking chair glide can be used for ganging purposes. To make transporting even easier for the 18" chair only, try the Classroom Select® chair dolly, sold separately. Glides are removable for carpet use. Contact your sales representative for replacement glides. Assembled.

Item #	Seat Height	Seat And Back Color	Frame Color	List Price
6-1597927-670	18 in	Specify	Chrome	\$124.95
6-1597928-670	30 in	Specify	Chrome	\$151.95

Item #	Description	List Price
6-2024418-670	Dolly for 18" Chairs	\$266.95



National Public Seating



### National Public Seating® 8700/8800 Series Cafetorium Stack Chairs

The Series #8700 Cafetorium Chair offers a sleek design with clean lines in a new futuristic look. Upholstered plush vinyl seat provides comfortable extended seating and is matched to a modern styled polypropylene plastic back that provides ergonomic back support. Also available in an all plastic version 8800 series in 4 popular colors with chrome frames. Extremely lightweight at 10 lbs, its 16-gauge frame provides support where you need it and is built to exceed ANSI BIFMA standards. Store or transport up to 35 chairs in the optional cradle style dolly. Floor protector glides are made of TPU for sensitive floors and include built-in gangers for multiple chair set up.

Please select color for the 8800 series chair.

Item #	Seat Height	Seat Color	Back Color	Frame Color	List Price
A 5-1510066-670	17-1/4 in	Black	Black	Chrome	\$154.95
5-1510068-670	17-1/4 in	Blue	Gray	Chrome	\$154.95
5-1510069-670	17-1/4 in	Navy	Navy	Black	\$154.95
B 5-2023332-670	31 in	Black	Black	Chrome	\$329.95
C 5-1584446-670	17-1/4 in	Specify	Specify	Chrome	\$142.95
D 5-2023333-670	31 in	Black	Black	Chrome	\$299.95

Chair Dolly for 17-1/4" chairs holds 35 chairs

6-1515265-670 Gray \$296.95

Dolly for 31" Cafe Height Stools holds 24 Stools

6-2027729-670 Gray \$401.95

#### NPS 8800 Series Chair Colors



### National Public Seating® 8500 High Density Stack Chairs

A comfortable plastic chair that features a 11mm steel rod chrome plated frame and comes equipped with protective floor glides to guard against skidding. The injection molded textured polypropylene seat and back is a color infused plastic and resists fading. A handle is integrated into the back to facilitate with the lifting and stacking of the chairs, enabling them to be stacked up to 40 chairs high. Optional right table arm (black) that can be used with the 8500 series.

#### NPS 8500 Series Colors



Item #	Seat Height	Seat Color	Frame Color	List Price
5-1364293-670	17 in	Specify	Chrome	\$117.95

Item #	Description	List Price
5-678529-670	Right Tablet Arm - Black	\$63.95

Item #	Frame Color	Capacity	List Price
Dolly 5-673299-670	Black	40	\$454.95



# office



Shown with optional casters



Shown with optional center drawer and slide out shelf

## CLASSROOM SELECT

### Classroom Select® Heavy-Duty Teacher's Desk

Classroom Select® teacher's desk feature pedestals that are heavy-duty all-welded construction. All drawers have full extension drawer slides and 100% of the drawer is accessible. File drawers have full-height sides to accommodate hanging files. Optional locking center drawer sold separately. The desks also have an optional slide-out shelf that can be on one pedestal or both. Specify base and top colors. Also specify left or right side when ordering single-pedestal desk.

Item #	Description	Product Dimensions	Top Color	Base Color	List Price
6-1487502-670	Single Pedestal Left/Right	48 W x 30 D x 29 H in	Specify	Specify	\$1,880.95
6-1386583-670	Double Pedestal	60 W x 24 D x 29 H in	Specify	Specify	\$1,977.95
6-1386584-670	Double Pedestal	72 W x 24 D x 29 H in	Specify	Specify	\$2,070.95
6-1386585-670	Double Pedestal	60 W x 30 D x 29 H in	Specify	Specify	\$2,493.95
6-1386586-670	Double Pedestal	72 W x 30 D x 29 H in	Specify	Specify	\$2,835.95
9-1474936-670	Center Drawer	21 W x 16 D x 2 H in			\$312.95
9-1474937-670	Slide Out Shelf	12 W x 13 D x 1 H in			\$216.95
9-1492395-670	8 Casters with Side Brakes	2 W x 2 D x 2 H in			\$151.95

### Classroom Select® Frame Colors



### Classroom Select® Laminate Colors

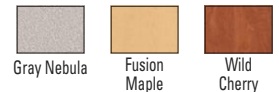

## CLASSROOM SELECT

### Classroom Select® Teacher's Desk

The Classroom Select® Teacher's desk is a quality desk solution designed for schools. The heavy-duty steel frame is available in either a Black or Platinum powder coated finish. Offered as a mobile option including four industrial casters, 2 locking, and 2 non-locking or a fully non-mobile option. Your choice of a single or double pedestal option. Desk top features a laminate T-Mold work surface promotes safety, with rounded corners, and is easy to clean and disinfect. Full extension on file and box drawers, featuring ball-bearing suspension. The central lock system locks all drawers.



A



B

Item #	Description	Product Dimensions	Top Color	Base Color	List Price
A 6-5008423-670	Single Pedestal w/o Casters	48 W x 30 D x 29-½ H in	Specify	Specify	\$760.95
6-5008422-670	Single Pedestal with Casters	48 W x 30 D x 29-½ H in	Specify	Specify	\$782.95
6-5008420-670	Double Pedestal w/o Casters	60 W x 30 D x 29-½ H in	Specify	Specify	\$892.95
B 6-5008421-670	Double Pedestal with Casters	60 W x 30 D x 29-½ H in	Specify	Specify	\$923.95



### Classroom Select® Teachers Desks Colors



CLASSROOM  
SELECT 



Classroom Select® NeoClass® Teacher's Desk Laminate Top Colors



Classroom Select® NeoClass® Teacher's Desk Edge Colors



Classroom Select® NeoClass® Mobile Teacher's Desk

Classroom Select® NeoClass® Mobile Podium Teacher's Desk is offered in multiple configurations and provides a functional "all in one" student-teacher meeting area and Teacher's presentation podium. Desks include perforated modesty panels for added style and structure and are made of strong durable steel throughout. The adjustable-height lectern with tilted top features a locking door with two adjustable interior shelves and a grommet for cord access. The lectern/podium measures 19-3/4" W x 20-3/4" D x 44.6" H. The podium top measures 20" W x 20" D and is height adjustable by 6". The desk/podium has standard heavy-duty locking/non-locking casters. Available in platinum steel frame with your choice of laminate finish and 13 T-Mold edge band colors.

Item #	Description	Product Dimensions	Top Color	Edge Color	List Price
A 6-1605466-670	Left/Right Pedestal	60 W x 30 D x 30 H in	Specify	Specify	\$1,692.95
A 6-1605467-670	Left/Right Pedestal	72 W x 30 D x 30 H in	Specify	Specify	\$1,813.95
B 6-1605468-670	Double Pedestal	60 W x 30 D x 30 H in	Specify	Specify	\$2,333.95
B 6-1605469-670	Double Pedestal	72 W x 30 D x 30 H in	Specify	Specify	\$2,415.95
C 6-1605470-670	Desk Right Return	60 W x 64 D x 30 H in	Specify	Specify	\$1,475.95
C 6-1605471-670	Desk Right Return	72 W x 76 D x 30 H in	Specify	Specify	\$1,631.95
D 6-1605472-670	Podium	19 W x 19 D x 45-49 H in	Specify	Specify	\$1,026.95
E 6-5003638-670	Right or Left Return Desk	72 W x 79 D x 30 H in	Specify	Specify	\$3,107.95
F 6-5008636-670	Conference Table	36 W x 28 D x 26 to 42 H in	Specify	Specify	\$557.95
G 6-5009519-670	Teacher Podium Desk <b>NEW</b>	24-1/2 W x 72 D x 44-1/2 H in	Specify	Specify	\$1,429.95

Item #	Description	Product Dimensions	Color	List Price
H 6-1605473-670	File Cabinet	15 W x 23-1/2 D x 30 H in	Specify	\$929.95

Item #	Description	Product Dimensions	List Price
9-1605474-670	Optional Drawer	16 W x 12 D x 2 H in	\$117.95





**FIVE YEAR  
5  
WARRANTY**



**Lorell Deluxe Adjustable Desk Riser**

Desk riser allows you to go from sitting to standing with ease. Stop at any position from 6-1/4" x 19-1/2" when adjusting the height. Desk riser operates with a double gas-spring monitor lift for smooth, easy ascension. The top worksurface includes a convenient tablet and smart phone slot. Quick-release keyboard tray provides easy reach to your keyboard even when standing and can detach easily when necessary.

Item #	Product Dimensions	Color	List Price
6-1597883-670	35-1/2 W x 36 D x 19-1/2 H in	Black	\$561.95
6-1597777-670	35-1/2 W x 36 D x 19-1/2 H in	White	\$561.95

**FIVE YEAR  
5  
WARRANTY**



**Lorell Adjustable Desk Riser**

Adjustable desk riser offers a healthy addition to any desk that allows you to sit or stand while you work. The large, 31 x 20 inch worksurface accommodates two monitors or a monitor and a laptop. Ergonomic keyboard tray moves up and down with the desk and moves out/in for the most comfortable position. Five height adjustments (up to over 16 inches above your desk) allow a comfortable standing position. Gas spring will allow you to easily move the desk up and down, even with your computer equipment. Riser is fully assembled for use right out of the box.

Item #	Product Dimensions	Color	List Price
6-1531625-670	32 W x 25 D x 16 H in	Black	\$626.95

**FIVE YEAR  
5  
WARRANTY**



**Lorell Electric Desk Riser with Keyboard Tray**

Electric desk riser with keyboard tray adjusts up and down with the push of a button. Height ranges from 5-1/4" to 17-1/8" off your worksurface. Electric motor provides a quick-release, low-noise operation. Anti-collision function will stop the up/down motion if desk riser meets objects like coffee cups or bottles.



Item #	Product Dimensions	Color	List Price
6-1597776-670	28-3/4 W x 35-3/4 D x 17 H in	Black	\$885.95

**FIVE YEAR  
5  
WARRANTY**



**Lorell Electric Desk Riser with Monitor Bracket**

Electric sit-to-stand desk riser adjusts up and down with the press of a button so you can easily enjoy the healthier, sit-stand approach to work. Adjust worksurface from 4-3/8" to 21-5/8" off your desk. Design includes stylish laminate top panel and keyboard tray.



Item #	Product Dimensions	Color	List Price
6-1597880-670	26-1/2 W x 25 D x 21-1/2 H in	Black	\$964.95

**FIVE YEAR  
5  
WARRANTY**



**Lorell XL Adjustable Desk Riser**

Full desk 46" wide top with a retractable keyboard tray. To optimize ergonomic work, this riser can be adjusted in height from 5" to 20 high. Straight up and down motion minimizes the amount of desk depth needed. Includes grommet hole for mounting monitor arm or running cables. Holds up to three monitors, a laptop and more.



Item #	Description	Top Color	List Price
6-2005680-670	Desk Riser	Black	\$883.95



**Victor High Rise Acacia Wood**

The laptop riser and standing desk are both great for college and high school students, employees working from home, or anyone with a small office setup looking to integrate a standing desk solution into their environment. Each desk features unique distinctive grain styling. Assembles and disassembles in less than 60 seconds.

**NEW**



Item #	Description	Product Dimensions	Color	List Price
6-2103079-670	Laptop Riser	17 W x 12 D x 16-1/2 H in	Woodgrain	\$256.95
6-2103080-670	Laptop Standing Desk	25 W x 12 D x 24 H in	Woodgrain	\$320.95



**Victor Adjustable Laptop Standing Desk**

This adjustable standing desk is specifically designed for laptop users that want the versatility and ease of a transportable standing desk. The adjustment from sitting to standing is smooth and effortless due to the two wheels on the legs. This standing desk gets you on your feet, while helping you improve your mental focus, and alleviating back and neck pain from sitting all day.

Item #	Description	Product Dimensions	Color	List Price
6-2103078-670	Laptop Standing Desk	28-3/4 W x 18-1/2 D x 16 H in	Black	\$257.95

**NEW**





### Victor® High Rise™ Mobile Adjustable Standing Desk

These Height Adjustable Standing Desks gives you the ergonomic benefits of a sit to stand desks plus the mobility of a cart. Wherever you need to go, your desk can follow. Rising to 44" and lowering to 29", the standard sitting height, these are the perfect ergonomic solution to your adjustable desk needs. The large work surface can accommodate a computer, keyboard and desktop necessities such as files, notes, calculator, or phone. These multi-functional tables can be used in multiple settings, including office, classroom, workshop, warehouse, lectern, healthcare, and any other application where mobility and variable height adjustment helps get the job done.

Item #	Description	Product Dimensions	Color	List Price
9-1588670-670	Mobile Standing Desk	30-3/4 W x 22 D in	Black	\$510.95



### Ergotron LearnFit® Adjustable Standing Desk

Transform classrooms and workstations into active learning environments with on-demand height-adjustable standing desks. With the simple squeeze of a hand lever, kids and adults can change the height of their desktops to their preferred level so they can work and collaborate in the way that is natural for them.

Item #	Product Dimensions	List Price
6-1562577-670	24 W x 22 D x 29-45 H in	\$946.95
6-1559013-670	24 W x 22 D x 34-50 H in	\$952.95

## LUXOR

### Luxor Adjustable Height Sit/Stand Desks

As classrooms and offices evolve to improve health and engagement, studies prove the benefits of sit/stand desks in aiding health, attention spans and collaboration. These sit/stand desk options provide freedom to sit or stand that fits into any office ambiance. Each option has a backpack hook, is height adjustable and has a durable steel construction with high-pressure laminate surface to withstand excessive use.

**Crank Adjusting Desk** - Height adjustable between 29" and 42". Crank handle neatly rests under desk or detaches for classroom management. Desktop has allotted space for pencils and a water bottle. Four casters aid student collaboration.

**Pneumatic Adjusting Desk** - Height adjustable between 29" and 43 1/2". Pneumatic lever allows students the ease and freedom to move between standing and sitting. Desktop has allotted space for pencils and a water bottle. Four casters aid student collaboration.

Item #	Top Size	List Price
<b>A</b> 6-1585865-670	27-1/2 W x 19-1/2 D in	\$638.95
<b>B</b> 6-1585866-670	27-1/2 W x 19-1/2 D in	\$759.95



# CLASSROOM SELECT



PRODUCT CERTIFIED FOR LOW CHEMICAL EMISSIONS: UL.COM/GG UL 2818



## Classroom Select® 69000 Series Colors



**Now Offered In Two New Colors!**



Shown in Mahogany

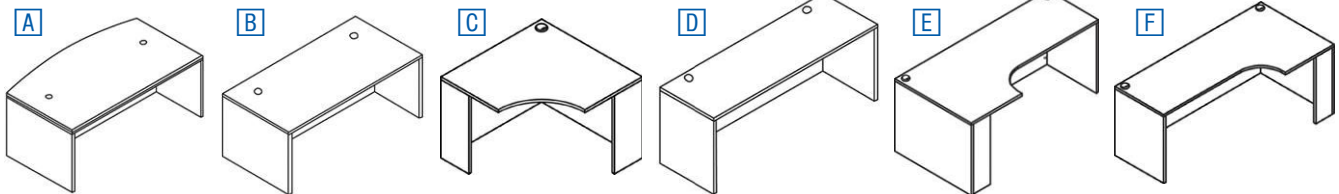

## Classroom Select® 69000 Laminate Furniture

The Classroom Select® 69000 Laminate Furniture has high-quality laminate construction and metal-to-metal cam-lock connections. Laminate top is 1" thick for durability. The desks feature two grommet holes for easy cord routing. Please specify color when ordering.

Item #	Product Dimensions	Color	List Price
<b>A Bowfront Desk Shells</b>			
6-1563860-670	70-7/8 Wx41-5/8 Dx29-1/2 H in	Cherry	\$609.95
6-1563859-670	70-7/8 Wx41-5/8 Dx29-1/2 H in	Mahogany	\$609.95
6-2048364-670	70-7/8 Wx41-5/8 Dx29-1/2 H in	Weathered Charcoal	\$609.95
6-2048365-670	70-7/8 Wx41-5/8 Dx29-1/2 H in	Espresso	\$609.95
<b>B Rectangular Desk Shells</b>			
6-1563868-670	47-1/4 Wx29-1/2 Dx29-1/2 H in	Cherry	\$398.95
6-1563867-670	47-1/4 Wx29-1/2 Dx29-1/2 H in	Mahogany	\$398.95
6-2027553-670	47-1/4 Wx29-1/2 Dx29-1/2 H in	Weathered Charcoal	\$398.95
6-1563866-670	59 Wx29-1/2 Dx29-1/2 H in	Cherry	\$425.95
6-1563865-670	59 Wx29-1/2 Dx29-1/2 H in	Mahogany	\$425.95
6-2027554-670	59 Wx29-1/2 Dx29-1/2 H in	Weathered Charcoal	\$425.95
6-2025044-670	59 Wx29-1/2 Dx29-1/2 H in	Espresso	\$425.95
6-1563864-670	66-1/8 Wx29-1/2 Dx29-1/2 H in	Cherry	\$462.95
6-1563863-670	66-1/8 Wx29-1/2 Dx29-1/2 H in	Mahogany	\$462.95
6-2027551-670	66-1/8 Wx29-1/2 Dx29-1/2 H in	Weathered Charcoal	\$462.95
6-2025049-670	66-1/8 Wx29-1/2 Dx29-1/2 H in	Espresso	\$462.95
6-1563862-670	70-7/8 Wx35-3/8 Dx29-1/2 H in	Cherry	\$554.95
6-1563861-670	70-7/8 Wx35-3/8 Dx29-1/2 H in	Mahogany	\$554.95
6-2027550-670	70-7/8 Wx35-3/8 Dx29-1/2 H in	Weathered Charcoal	\$554.95
6-2025050-670	70-7/8 Wx35-3/8 Dx29-1/2 H in	Espresso	\$554.95
<b>C Corner Desk</b>			
6-1563872-670	41-3/8 Wx41-3/8 Dx29-1/2 H in	Cherry	\$469.95
6-1563871-670	41-3/8 Wx41-3/8 Dx29-1/2 H in	Mahogany	\$469.95
6-2048362-670	41-3/8 Wx41-3/8 Dx29-1/2 H in	Weathered Charcoal	\$469.95
6-2048363-670	41-3/8 Wx41-3/8 Dx29-1/2 H in	Espresso	\$469.95

Item #	Product Dimensions	Color	List Price
<b>D Credenza Shells</b>			
6-1563870-670	47-1/4 Wx23-5/8 Dx29-1/2 H in	Cherry	\$372.95
6-1563869-670	47-1/4 Wx23-5/8 Dx29-1/2 H in	Mahogany	\$372.95
6-2027552-670	47-1/4 Wx23-5/8 Dx29-1/2 H in	Weathered Charcoal	\$372.95
6-2025043-670	47-1/4 Wx23-5/8 Dx29-1/2 H in	Espresso	\$372.95
6-1563878-670	59 Wx23-5/8 Dx29-1/2 H in	Cherry	\$400.95
6-1563877-670	59 Wx23-5/8 Dx29-1/2 H in	Mahogany	\$400.95
6-2027562-670	59 Wx23-5/8 Dx29-1/2 H in	Weathered Charcoal	\$400.95
6-2025040-670	59 Wx23-5/8 Dx29-1/2 H in	Espresso	\$400.95
6-1563876-670	66-1/8 Wx23-5/8 Dx29-1/2 H in	Cherry	\$437.95
6-1563875-670	66-1/8 Wx23-5/8 Dx29-1/2 H in	Mahogany	\$437.95
6-2048326-670	66-1/8 Wx23-5/8 Dx29-1/2 H in	Weathered Charcoal	\$437.95
6-2048358-670	66-1/8 Wx23-5/8 Dx29-1/2 H in	Espresso	\$437.95
6-1563874-670	70-7/8 Wx23-5/8 Dx29-1/2 H in	Cherry	\$419.95
6-1563873-670	70-7/8 Wx23-5/8 Dx29-1/2 H in	Mahogany	\$419.95
<b>E Left Corner Credenzas</b>			
6-1563882-670	66-1/8 Wx35-3/8 Dx29-1/2 H in	Cherry	\$580.95
6-1563881-670	66-1/8 Wx35-3/8 Dx29-1/2 H in	Mahogany	\$580.95
6-1563880-670	70-7/8 Wx35-3/8 Dx29-1/2 H in	Cherry	\$592.95
6-1563879-670	70-7/8 Wx35-3/8 Dx29-1/2 H in	Mahogany	\$592.95
6-2048357-670	70-7/8 Wx35-3/8 Dx29-1/2 H in	Weathered Charcoal	\$592.95
6-2048356-670	70-7/8 Wx35-3/8 Dx29-1/2 H in	Espresso	\$592.95
<b>F Right Corner Credenzas</b>			
6-1563886-670	66-1/8 Wx35-3/8 Dx29-1/2 H in	Cherry	\$552.95
6-1563885-670	66-1/8 Wx35-3/8 Dx29-1/2 H in	Mahogany	\$552.95
6-1563884-670	70-7/8 Wx35-3/8 Dx29-1/2 H in	Cherry	\$630.95
6-1563883-670	70-7/8 Wx35-3/8 Dx29-1/2 H in	Mahogany	\$630.95
6-2048320-670	70-7/8 Wx35-3/8 Dx29-1/2 H in	Weathered Charcoal	\$630.95
6-2048353-670	70-7/8 Wx35-3/8 Dx29-1/2 H in	Espresso	\$630.95





Shown in Mahogany

**CLASSROOM  
SELECT**



PRODUCT CERTIFIED  
FOR LOW CHEMICAL  
EMISSIONS:  
UL.COM/GG  
UL 2818



PLEASE  
SPECIFY  
**COLOR  
CHOICE**

Please refer to page 214  
for all color selections.

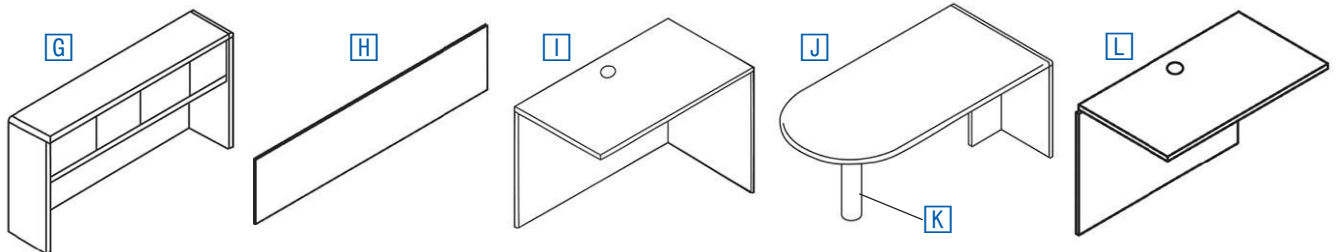

Item #	Product Dimensions	Color	List Price
<b>G Hutch with Doors</b>			
6-1563894-670	47-1/4 Wx14-3/4 Dx36 H in	Cherry	\$579.95
6-1563893-670	47-1/4 Wx14-3/4 Dx36 H in	Mahogany	\$579.95
6-2048594-670	47-1/4 Wx14-3/4 Dx36 H in	Weathered Charcoal	\$579.95
6-2048561-670	47-1/4 Wx14-3/4 Dx36 H in	Espresso	\$579.95
6-1563892-670	59 Wx14-3/4 Dx36 H in	Cherry	\$608.95
6-1563891-670	59 Wx14-3/4 Dx36 H in	Mahogany	\$608.95
6-2048543-670	59 Wx14-3/4 Dx36 H in	Weathered Charcoal	\$608.95
6-2048547-670	59 Wx14-3/4 Dx36 H in	Espresso	\$608.95
6-1563890-670	66-1/8 Wx14-3/4 Dx36 H in	Cherry	\$669.95
6-1563889-670	66-1/8 Wx14-3/4 Dx36 H in	Mahogany	\$669.95
6-2048544-670	66-1/8 Wx14-3/4 Dx36 H in	Weathered Charcoal	\$669.95
6-2048542-670	66-1/8 Wx14-3/4 Dx36 H in	Espresso	\$669.95
6-1563888-670	70-7/8 Wx14-3/4 Dx36 H in	Cherry	\$725.95
6-1563887-670	71-3/4 Wx15 Dx36 H in	Mahogany	\$725.95
6-2027565-670	71-3/4 Wx15 Dx36 H in	Weathered Charcoal	\$725.95
6-2025069-670	70-7/8 Wx14-3/4 Dx36 H in	Espresso	\$725.95
<b>H Tackboards</b>			
6-1442665-670	45 Wx16-1/2 H in	Black	\$76.95
6-1442664-670	56-3/4 Wx16-1/2 H in	Black	\$86.95
6-1442663-670	63-7/8 Wx16-1/2 H in	Black	\$89.95
6-1442662-670	68-5/8 Wx16-1/2 H in	Black	\$101.95
<b>I Return Shells</b>			
6-1563902-670	35-5/8 Wx23-5/8 Dx29-1/2 H in	Cherry	\$248.95
6-1563901-670	35-5/8 Wx23-5/8 Dx29-1/2 H in	Mahogany	\$248.95
6-2048581-670	35-5/8 Wx23-5/8 Dx29-1/2 H in	Weathered Charcoal	\$248.95

Item #	Product Dimensions	Color	List Price
6-2048554-670	35-5/8 Wx23-5/8 Dx29-1/2 H in	Espresso	\$248.95
6-1563900-670	41-5/8 Wx23-5/8 Dx29-1/2 H in	Cherry	\$314.95
6-1563899-670	41-5/8 Wx23-5/8 Dx29-1/2 H in	Mahogany	\$314.95
6-2027567-670	41-5/8 Wx23-5/8 Dx29-1/2 H in	Weathered Charcoal	\$314.95
6-2025158-670	41-5/8 Wx23-5/8 Dx29-1/2 H in	Espresso	\$314.95
6-1563898-670	47-1/4 Wx23-5/8 Dx29-1/2 H in	Cherry	\$333.95
6-1563897-670	47-1/4 Wx23-5/8 Dx29-1/2 H in	Mahogany	\$333.95
6-2027568-670	47-1/4 Wx23-5/8 Dx29-1/2 H in	Weathered Charcoal	\$333.95
6-2025160-670	47-1/4 Wx23-5/8 Dx29-1/2 H in	Espresso	\$333.95
<b>J Peninsulas</b>			
6-1563906-670	66-1/8 Wx29-1/2 Dx29-1/2 H in	Cherry	\$337.95
6-1563905-670	66-1/8 Wx29-1/2 Dx29-1/2 H in	Mahogany	\$337.95
6-2103888-670	66-1/8 Wx29-1/2 Dx29-1/2 H in	Weathered Charcoal	\$337.95
6-2103889-670	66-1/8 Wx29-1/2 Dx29-1/2 H in	Espresso	\$337.95
<b>K Black Post for Peninsula</b>			
6-1442671-670	6 Wx6 Dx28 H in	Black	\$150.95
<b>L Bridges</b>			
6-1563910-670	41-3/8 Wx23-5/8 Dx29-1/2 H in	Cherry	\$249.95
6-1563909-670	41-3/8 Wx23-5/8 Dx29-1/2 H in	Mahogany	\$249.95
6-1563908-670	47-1/4 Wx23-5/8 Dx29-1/2 H in	Cherry	\$271.95
6-1563907-670	47-1/4 Wx23-5/8 Dx29-1/2 H in	Mahogany	\$271.95
6-2027570-670	47-1/4 Wx23-5/8 Dx29-1/2 H in	Weathered Charcoal	\$271.95
6-2025159-670	47-1/4 Wx23-5/8 Dx29-1/2 H in	Espresso	\$271.95

CLASSROOM  
SELECT 



PRODUCT CERTIFIED  
FOR LOW CHEMICAL  
EMISSIONS:  
UL COM/IGG  
UL 2818



Refer to pages 214  
for color options.



Shown in Cherry

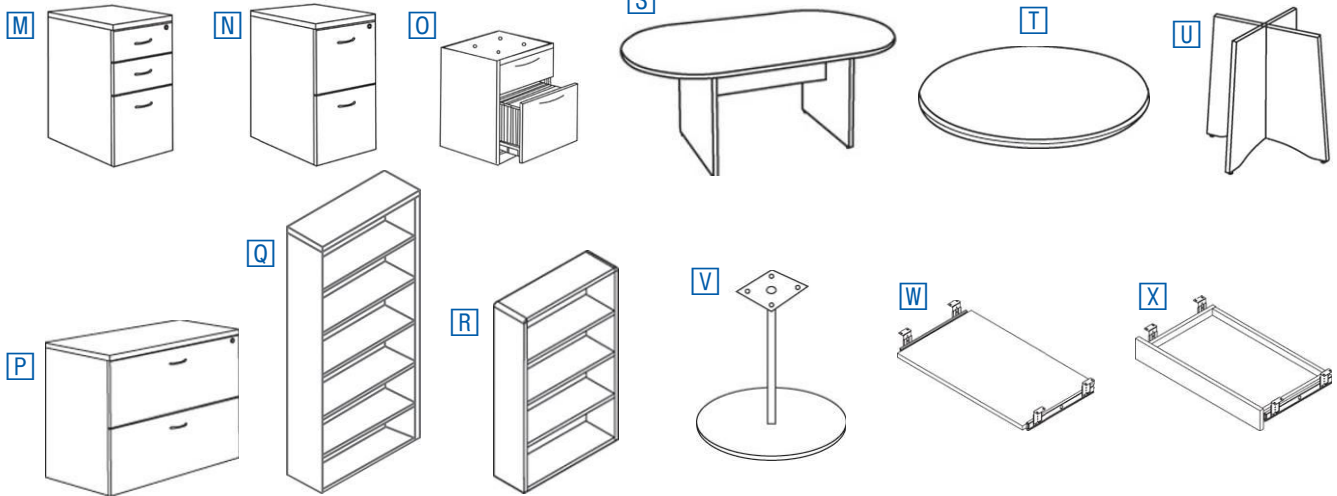

Item #	Product Dimensions	Color	List Price
<b>M Box/Box/File Pedestals</b>			
6-1563912-670	15-3/4 Wx22 Dx28-5/8 H in	Cherry	\$487.95
6-1563911-670	15-3/4 Wx22 Dx28-5/8 H in	Mahogany	\$487.95
6-2028028-670	15-3/4 Wx22 Dx28-5/8 H in	Weathered Charcoal	\$487.95
6-2025149-670	15-3/4 Wx22 Dx28-5/8 H in	Espresso	\$487.95
<b>N File/File Pedestals</b>			
6-1563914-670	15-3/4 Wx22 Dx28-5/8 H in	Cherry	\$472.95
6-1563913-670	15-3/4 Wx22 Dx28-5/8 H in	Mahogany	\$472.95
6-2028027-670	15-3/4 Wx22 Dx28-5/8 H in	Weathered Charcoal	\$472.95
6-2025152-670	15-3/4 Wx22 Dx28-5/8 H in	Espresso	\$472.95
<b>O Box/File Hanging Pedestals</b>			
6-1563916-670	15-1/2 Wx21-7/8 Dx18-7/8 H in	Cherry	\$325.95
6-1563915-670	15-1/2 Wx21-7/8 Dx18-7/8 H in	Mahogany	\$325.95
6-2027571-670	15-1/2 Wx21-7/8 Dx18-7/8 H in	Weathered Charcoal	\$325.95
6-2025147-670	15-1/2 Wx21-7/8 Dx18-7/8 H in	Espresso	\$325.95
<b>P Lateral File</b>			
6-1454002-670	35-1/2 Wx22 Dx29-1/2 H in	Cherry	\$817.95
6-1453873-670	35-1/2 Wx22 Dx29-1/2 H in	Mahogany	\$817.95
6-2103886-670	35-1/2 Wx22 Dx29-1/2 H in	Weathered Charcoal	\$817.95
6-2103885-670	35-1/2 Wx22 Dx29-1/2 H in	Espresso	\$817.95
<b>Q 6-Shelf Bookcase</b>			
6-1575465-670	36 Wx12 Dx72 H in	Cherry	\$523.95
6-2027579-670	36 Wx12 Dx72 H in	Weathered Charcoal	\$523.95
6-2025341-670	36 Wx12 Dx72 H in	Espresso	\$523.95
<b>R 4-Shelf Bookcase</b>			
6-1575459-670	36 Wx12 Dx48 H in	Cherry	\$389.95
6-1575458-670	36 Wx12 Dx48 H in	Mahogany	\$389.95
6-2028031-670	36 Wx12 Dx48 H in	Weathered Charcoal	\$389.95
6-2024464-670	36 Wx12 Dx48 H in	Espresso	\$389.95

Item #	Product Dimensions	Color	List Price
<b>S Oval Conference Table</b>			
6-1453982-670	70-15/16 Wx35-7/16 Dx29-1/2 H	Cherry	\$606.95
6-1311547-670	72 Wx36 Dx29-1/2 H in	Mahogany	\$606.95
6-2103884-670	70-15/16 Wx35-7/16 Dx29-1/2 H	Weathered Charcoal	\$606.95
6-2025085-670	70-15/16 Wx35-7/16 Dx29-1/2 H	Espresso	\$606.95
<b>T Round Tops</b>			
6-1452768-670	41-3/4 Dia x 1-1/4 H in	Cherry	\$250.95
6-1311530-670	41-7/16 Dia x 1 H in	Mahogany	\$250.95
6-2048432-670	41-7/16 Dia x 1 H in	Weathered Charcoal	\$250.95
6-2048467-670	41-7/16 Dia x 1 H in	Espresso	\$250.95
6-1576383-670	47-1/4 Dia x 1-1/4 H in	Cherry	\$261.95
6-1311531-670	47-1/4 Dia x 1-1/4 H in	Mahogany	\$261.95
6-2048456-670	47-1/4 Dia x 1-1/4 H in	Weathered Charcoal	\$261.95
6-2048472-670	47-1/4 Dia x 1-1/4 H in	Espresso	\$261.95
<b>U Laminate Base for 42" &amp; 48" Tops</b>			
6-1468555-670	24 Dia x 29 H in	Cherry	\$193.95
6-1576382-670	29-1/2 Wx29-1/2 Dx28-1/2 H in	Mahogany	\$193.95
6-2048424-670	24 Dia x 29 H in	Weathered Charcoal	\$193.95
6-2048519-670	29-1/2 Wx29-1/2 Dx28-1/2 H in	Espresso	\$193.95
<b>V Metal Base for 42" &amp; 48" Tops</b>			
6-1311532-670	23-5/8 Wx23-5/8 Dx28-1/2 H in	Black	\$498.95
<b>W Keyboard Tray</b>			
6-1563858-670	25-1/2 Wx15 Dx1 H in	Cherry	\$147.95
6-1563857-670	25-1/2 Wx15 Dx1 H in	Mahogany	\$147.95
6-2024867-670	26 Wx15 Dx1 H in	Weathered Charcoal	\$147.95
6-2024883-670	26 Wx15 Dx1 H in	Espresso	\$147.95
<b>X Center Drawer</b>			
6-1563856-670	17 Wx28 Dx5 H in	Cherry	\$203.95

# AIS

**AIS Calibrate Series Laminate Colors**

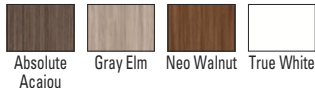

**Calibrate Series**

The Calibrate® family of laminate products can fill the entire space with coordinated, high quality, beautiful solutions. All its elements have been intentionally designed with compatible dimensions to ensure proper fit while sharing key design features such as finishes and hardware within the family - and often across other AIS lines. The result is clean reveals, tight tolerances and smooth alignment ensuring a cohesive aesthetic throughout your facility. Plan with a portion of the Calibrate® family or plan with all of it: casegoods, storage, formal and informal conference tables, open plan desking system and reception. The choice is yours.

**Affordable Interior Systems Calibrate® Series Double Pedestal Teacher Desk**

Includes:

- Full Modesty Panel Desk Shell - 72 W x 24 D x 29 H in
- Full Depth Big Box File Pedestal – 16 W x 18 D x 28 H in
- Full Depth Full File Pedestal – 16 W x 18 D x 28 H in

Item #	Description	Product Dimensions	Top Color	List Price
6-5008988-670	Double Pedestal Desk	72 W x 24 D x 29 H in	Specify	\$1,606.95



**Affordable Interior Systems® Calibrate Series Single Pedestal Teacher Desk**

Includes:

- Partial Depth Big Box File Pedestal – 16 W x 23 D x 28 H in
- Full Modesty Desk Shell – 60 W x 30 D x 29 H in

Item #	Description	Product Dimensions	Top Color	List Price
6-5008966-670	Single Pedestal Desk	66 W x 30 D x 29 H in	Specify	\$1,201.95



**Affordable Interior Systems Calibrate® Series Double Pedestal Admin Desk**

Includes:

- Right Return – 48 W x 24 D x 29 H in
- Full Modesty Desk Shell – 72 W x 30 D x 29 H in
- Partial Depth Big Box File Pedestal – 16 W x 23 D x 28 H in
- Partial Depth Full File Pedestal – 16 W x 23 D x 28 H in

Item #	Description	Product Dimensions	Top Color	List Price
6-5008980-670	Double Pedestal Desk	78 W x 30 D x 29 H in	Specify	\$2,604.95



**Affordable Interior Systems Calibrate® Series Double Pedestal L-Shaped Desk**

Includes:

- Right Return – 48 W x 24 D x 29 H in
- Full Modesty Desk Shell – 72 W x 30 D x 29 H in
- Partial Depth Big Box File Pedestal – 16 W x 23 D x 28 H in
- Partial Depth Full File Pedestal – 16 W x 23 D x 28 H in
- Single Hutch with Cabinet Doors – 78 w x 14 D x 37 H in
- Tackboard Hutch Mount – 78 W x 20 H in

Item #	Description	Product Dimensions	Top Color	List Price
6-5008984-670	Double Pedestal Desk	78 W x 30 D x 29 H in	Specify	\$3,681.95



# AIS

### AIS Calibrate Series Laminate Colors

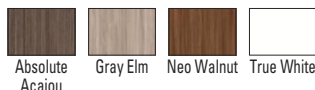

## Calibrate Series

The Calibrate® family of laminate products can fill the entire space with coordinated, high quality, beautiful solutions. All its elements have been intentionally designed with compatible dimensions to ensure proper fit while sharing key design features such as finishes and hardware within the family - and often across other AIS lines. The result is clean reveals, tight tolerances and smooth alignment ensuring a cohesive aesthetic throughout your facility. Plan with a portion of the Calibrate® family or plan with all of it: casegoods, storage, formal and informal conference tables, open plan deskings system and reception. The choice is yours.



### Affordable Interior Systems Calibrate® Series Double Pedestal U-Shape Desk

- Includes:
- Bridge with Full Modesty Flush – 48 W x 24 D x 29 H in
  - Full Modesty Desk Shell – 72 W x 30 D x 29 H in
  - Full Modesty Flush Desk Shell – 72 W x 24 D x 29 H in
  - Partial Depth Big Box File Pedestal – 16 W x 23 D x 28 H in
  - Partial Depth Full File Pedestal – 16 W x 23 D x 28 H in
  - Single Hutch with Cabinet Doors – 72 W x 14 D x 37 H in
  - Tackboard Hutch Mount – 72 W x 20 H in
  - Wardrobe Cabinet – Right Door – 24 W x 24 D x 66 H in

Item #	Description	Product Dimensions	Top Color	List Price
6-5008990-670	Double Pedestal Desk	8 x 8 Ft	Specify	\$6,028.95

### Affordable Interior Systems Calibrate® Series Principal Office

- Includes:
- Paxton Black Mesh Seat with Casters
  - Right Return – 72 W x 24 D x 29 H in
  - Bridge with Full Modesty Flush – 42 W x 24 D x 29 H in
  - Full Modesty Desk Shell – 72 W x 36 D x 29 H in
  - Full Depth Big Box File Pedestal – 16 W x 30 D x 28 H in
  - Partial Depth Full File Pedestal – 16 W x 23 D x 28 H in
  - Single Hutch with Cabinet Doors – 72 W x 14 D x 45 H in
  - Tackboard Hutch Mount – 72 W x 28 H in
  - Square Table with Glides – 42 D x 29 H in
  - Plastic Pencil Drawer – 21-1/4 W x 16-1/4 D x 2-1/4 H in
  - 40 LED Task Light with Dimmer and Transformer



Item #	Description	Product Dimensions	Color	List Price
6-5009066-670	Admin Desk	8-1/2 x 6 ft	Specify	\$6,446.95



### Affordable Interior Systems Calibrate® Series Open Leg U-Shape Desk

- Includes:
- Bolton Mid-Back Conference Seat with Black Frame
  - Overhead Wall Mount with Framed Cabinet Doors – 72 W x 14 D x 16 H in
  - Full Depth Lateral Big Box File – 30 W x 24 D x 28 H in
  - Suspended Modesty Panel – 72 W x 12 H in
  - Flat Plate
  - U-Channel – 48 W in
  - Support – FLSP C – Male Centered – 30 D in
  - Support – FLSP F – Female End – 12 D in
  - OLEG 27 x 24 in – Free Standing
  - OLEG 27 x 30 in – Free Standing
  - Rectangular Worksurface – 72 W x 24 D in
  - Rectangular Worksurface – 48 W x 30 D in
  - Rectangular Worksurface – 72 W x 30 D in

Item #	Description	Product Dimensions	Color	List Price
6-5009068-670	Admin Desk	6-1/2 x 6 ft	Specify	\$5,968.95

### Affordable Interior Systems Calibrate® Series U-Shape Desk

- Includes:
- Bolton Mid-Back Conference Seat with Black Frame
  - Paxton Side Chair with Casters – Black Mesh Back
  - Bridge with Full Modesty Flush – 48 W x 24 D x 29 H in
  - Full Modesty Desk Shell – 84 W x 30 D x 29 H in
  - Full Depth Big Box File Pedestal – 16 W x 24 D x 28 H in
  - Full Depth Lateral Big Box File – 30 W x 24 D x 28 H in
  - Single Hutch with Cabinet Doors – 66 W x 14 D x 37 H in
  - Stack-On 2 Door Cabinet – 30 W x 14 D x 37 H in
  - Tackboard Hutch Mount – 66 W x 20 H in
  - Round Table with Glides – 36 D x 29 H in
  - Rectangular Worksurface – 96 W x 24 D in
  - Desking L-Bracket - Black



Item #	Description	Product Dimensions	Color	List Price
6-5009065-670	Admin Desk	6-1/2 x 6 ft	Specify	\$6,143.95



**Suggested Layout 1**

- 1506200 **Fabric Panels (4)**      1506208 **90° Connector (1)**
- 1506207 **Straight Connectors (2)**      1506211 **Shelf (1)**



**Suggested Layout 2**

- 1506201 **Fabric Panels (4)**      1506207 **Straight Connectors (5)**
- 1506203 **Fabric Panels (2)**      1506208 **90° Connectors (7)**
- 1506206 **Fabric Panels (2)**      1506211 **Shelves (4)**

**Suggested Layout 3**

- 1506199 **Fabric Panels (2)**      1506207 **Straight Connectors (5)**
- 1506200 **Fabric Panels (5)**      1506208 **90° Connectors (4)**
- 1506205 **Fabric Panels (3)**      1506211 **Shelves (2)**



**Lorell Panel Systems**

Create the panel configuration you need with a variety of sizes available. The semi-tackable, gray panels help block sound and provide privacy. Each panel includes adjustable glides for better leveling. An accessory shelf adds overhead storage and includes mounting hardware. Versatile connectors to secure panels are sold separately.

Item #	Description	Product Dimensions	List Price	Item #	Description	Product Dimensions	List Price
<b>Panels</b>							
6-1506198-670	Privacy Screen	60-3/8 W x 71 H in	\$746.95	A	6-1506207-670	Connector	1-1/4 W x 2-1/4 D x 5/8 H in
6-1506199-670	Privacy Screen	48-3/8 W x 71 H in	\$695.95	B	6-1506208-670	Connector	2-1/4 W x 2-1/4 D x 5/8 H in
6-1506200-670	Privacy Screen	36-3/8 W x 71 H in	\$656.95	<b>Panel Accessories</b>			
6-1506201-670	Privacy Screen	30-1/2 W x 71 H in	\$606.95	C	6-1506209-670	Feet	2 W x 18-3/8 D x 1-7/8 H in
6-1506202-670	Privacy Screen	72-1/2 W x 1-1/2 D x 60 H in	\$636.95	D	6-1575027-670	Mobile T-Foot Set	\$167.95
6-1506203-670	Privacy Screen	60-3/4 W x 59-1/4 H in	\$612.95	E	6-1506210-670	Wall Bracket	2-1/2 W x 3-3/4 D x 2-1/2 H in
6-1506204-670	Privacy Screen	48-3/4 W x 60 H in	\$556.95	F	6-1506211-670	Shelf	56-1/4 W x 11-3/4 D x 14-1/4 H in
6-1506205-670	Privacy Screen	36-3/4 W x 60 H in	\$553.95				\$297.95
6-1506206-670	Privacy Screen	30-1/2 W x 59-1/4 H in	\$550.95				



Shown in Mahogany



Weathered Charcoal Rectangle Top



Mahogany Rectangle Top



Wide Single Leg



Middle Unit Leg

### Conference Table Tops & Bases

Rectangular tops combine with wide side legs and middle unite leg to create the Revelance conference table size you need. 1 inch thick tabletop features a 3mm thick PVC edge banding that matches the laminate finish. Leg frame is made of metal with a silver powder-coated surface for durability. Combine tops to make conference tables up to 144 W x 48 D.

Item #	Description	Product Dimensions	Color	List Price
6-2048509-670	Rectangle Top	60 W x 47 D x H 1 in	Mahogany	\$467.95
6-2048445-670	Rectangle Top	60 W x 47 D x H 1 in	Weathered Charcoal	\$467.95
6-2048444-670	Rectangle Top	71-1/2 W x 47 D x H 1 in	Mahogany	\$512.95
6-2048489-670	Rectangle Top	71-1/2 W x 47 D x 1 H in	Weathered Charcoal	\$512.95
6-2048564-670	Wide Side Leg	45-1/2 W x 4 D x 28-1/2 H in	Silver	\$440.95
6-2048582-670	Middle Unit Leg	38-1/2 W x 6 D x 28-1/2 H in	Silver	\$519.95



Knife Edge Detail







Shown in Tan with Walnut coffee tables.



### Lorell® Accession Collection

The Accession Collection features bonded leather with mahogany-stained legs. Coffee tables come with a top panel with melamine and 1.5mm PVC edgebanding, black powder coat steel base. Covered by a 5-year limited warranty.

Item #	Description	Product Dimensions	Color	List Price
<b>Sofas</b>				
A 6-1575023-670	Reception Sofa	75 W x 31-1/8 D x 34-1/2 H in	Tan	\$3,439.95
<b>LoveSeats</b>				
B 6-1505929-670	Loveseat Sofa	55 W x 31-1/4 D x 34-1/2 H in	Black	\$2,105.95
B 6-1575024-670	Loveseat Sofa	55 W x 31-1/4 D x 34-1/2 H in	Tan	\$2,105.95
<b>Club Chairs</b>				
C 6-1505930-670	Club Chair	36 W x 34-1/2 D x 31-1/3 H in	Black	\$1,748.95
C 6-1575025-670	Club Chair	36 W x 34-1/2 D x 31-1/3 H in	Tan	\$1,748.95
C 6-1505931-670	Club Chair with Tablet	36 W x 34-1/2 D x 31-1/3 H in	Black	\$1,934.95
<b>Coffee Tables</b>				
D 6-2048506-670	Round Coffee Table	31-1/2 D x 16-3/4 H in	Walnut	\$277.95
D 6-2048494-670	Round Coffee Table	31-1/2 D x 16-3/4 H in	Weathered Charcoal	\$277.95
<b>End Tables</b>				
E 6-2048428-670	Round End Table	19 D x 19-3/4 H in	Walnut	\$168.95
E 6-2048442-670	Round End Table	19 D x 19-3/4 H in	Weathered Charcoal	\$168.95





CLASSROOM  
**SELECT**

**Classroom Select® Mesh Guest Chair**

Stackable guest chair features a mesh back to mold to your natural curvature. The exhaust vent in the plastic cover under the fabric-upholstered, cushioned seat offers even more breathability. Nylon pads top the fixed arms that are built into the four square tube legs. Use for your lobby or large meeting areas. Chairs stack up to four high. Seat measures 18-<sup>3</sup>/<sub>4</sub>" W x 18-<sup>3</sup>/<sub>8</sub>" D x 18-<sup>1</sup>/<sub>8</sub>" H. Back size is 17-<sup>3</sup>/<sub>8</sub>" W x 14" H.

Item #	Description	Product Dimensions	Fabric Color	List Price
6-1498097-670	Guest Chair No Casters	22- <sup>7</sup> / <sub>8</sub> W x 22- <sup>5</sup> / <sub>8</sub> D x 32- <sup>1</sup> / <sub>8</sub> H in	Black	\$409.95
Item #	Description	Product Dimensions	Fabric Color	List Price
6-1591920-670	Guest Chair w/ Casters	22- <sup>7</sup> / <sub>8</sub> W x 22- <sup>5</sup> / <sub>8</sub> D x 32- <sup>1</sup> / <sub>8</sub> H in	Black	\$472.95
Item #	Product Dimensions	Seat Color	List Price	
6-1591921-670	23- <sup>5</sup> / <sub>8</sub> W x 22- <sup>7</sup> / <sub>8</sub> D x 42- <sup>7</sup> / <sub>8</sub> H in	Black	\$586.95	



CLASSROOM  
**SELECT**

**Classroom Select® Deluxe Mesh Back Chairs**

Mesh-back chairs feature fabric or mesh cushioned seats with mesh backs that are ergonomically designed for the natural curvature of a person's back. Arms adjust in height and width. Meets CA117 fire retardant standards. The mesh back chairs with color options ship in approximately three weeks and are nonreturnable. Additional colors available online.

Item #	Description	Product Dimensions	Color	List Price
6-1442637-670	Guest Chair	27 W x 27- <sup>1</sup> / <sub>2</sub> D x 41 H in	Black	\$494.95

NEW



AIS

NEW



**Affordable Interior Systems Devens Side Chairs**

The Devens Side Chair is a natural complement to both the Devens Task Chair and the Devens Stool. This cantilevered stacking chair provides an elegant and light look whether used in a private office as guest seating or by itself in a meeting room. The mesh, curved back mimics the contour of the spine for added comfort. Chairs can be stacked up to four high when not in use.

Item #	Description	Product Dimensions	Fabric Color	Frame Color	List Price
6-2089243-670	Stacking Guest Chair	22- <sup>1</sup> / <sub>2</sub> W x 23 D x 32- <sup>1</sup> / <sub>2</sub> H in	Black	Aluminum	\$447.95
6-2089249-670	Stacking Guest Chair	22- <sup>1</sup> / <sub>2</sub> W x 23 D x 32- <sup>1</sup> / <sub>2</sub> H in	Gray	Aluminum	\$447.95

**Affordable Interior Systems Side Paxton Chairs**

Paxton loves being around people—in the café, training space, classroom, waiting room, auditorium, basically anywhere with a floor. With or without casters, it's soft, stackable, and supremely comfortable. Beloved for its mesh back, soft edges, and welcoming price point, this side chair serves the need, then stacks up to save space.

Item #	Description	Product Dimensions	Fabric Color	Frame Color	List Price
6-2089254-670	With Glides	23 W x 21 D x 32 H in	Black	Black	\$236.95
6-2089250-670	With Casters	23 W x 21 D x 32 H in	Black	Black	\$247.95

CLASSROOM  
SELECT 

**TASK CHAIR**  
COMFORT & FUNCTIONALITY



















- Ergonomically designed back for best fit
- Adjustable arm width and height
- Comfortable mesh fabric cushioned seat
- Progressive waterfall front seat edge promotes good circulation and relieves pressure points
- Pneumatic seat height adjustment, back height adjustment, 360 degree swivel, tilt and asynchronous three lever control
- 5-star base for stability and easy movement
- Attractive black color
- Most Classroom Select® task seating is quickship



Go to pages 226-235 for Classroom Select® task chairs

**TASK CHAIR OPTION CHART**

Use this chart to identify task chair options on pages 226-235.















1	 <b>tilt tension control</b> Increase or decrease tilt tension depending on user's body-weight.	7	 <b>seat height adjustment</b> Raise or lower so your feet rest flat on the floor. This will accommodate individuals of all different heights.	13	 <b>arm height adjustment</b> Raise or lower so your forearms rest comfortably while typing at a computer and working at your desk.
2	 <b>center-tilt</b> Chair tilts from a point under the center of the seat allowing you to rock. Tension adjustable.	8	 <b>waterfall seat</b> Reduces pressure at the back of the knee allowing for good blood flow.	14	 <b>seat angle adjustment</b> Seat angle will lock in any position from front to back.
3	 <b>knee-tilt</b> Chair tilts from a point at the front of the seat keeping your feet on the floor as you rock. Tension adjustable.	9	 <b>forward seat tilt</b> Allows chair to tilt forward changing the angle of your thighs in relation to the floor. Allows for full back support when working at a computer.	15	 <b>swivel arm</b> Arm swivels left to right
4	 <b>tilt lock</b> Lock in positions to accommodate your posture.	10	 <b>back height adjustment</b> Raise or lower to support the lumbar (lower back) region.	16	 <b>arm depth adjustment</b> Arm moves forward and backward.
5	 <b>back angle adjustment</b> Adjust to change the angle of the back in relation to the seat. Will allow for multiple angles based on individual's size.	11	 <b>seat depth adjustment</b> Change the depth of the seat to accommodate the length of your thighs. Keeps your back in contact with the backrest while avoiding pressure behind your knees.	17	 <b>ratchet back height adjustment</b> Easily raise back with upward ratchet to support the lumbar (lower back) region.
6	 <b>synchro-tilt</b> Backrest and seat tilt in unison. Back tilts more than seat and is tension adjustable.	12	 <b>width adjustable arms</b> Adjusts arms inward or outward to match an individual's shoulder span for maximum comfort.	18	 <b>integral lumbar support</b> Easily adjusts to enhance comfort.



# Task Chair Features

Page #	Image	Brand	Item #	List Price	tilt tension control	center-tilt	knee-tilt	tilt lock	back angle adjustment	synchro-tilt	seat height adjustment	waterfall seat	forward seat tilt	back height adjustment	seat depth adjustment	width adjustable arms	arm height adjustment	integral lumbar support
226		CLASSROOM SELECT	6-1498101-670	\$292.95							●			●	●			
226		CLASSROOM SELECT	6-1480183-670	\$347.95	●	●		●			●							
226		CLASSROOM SELECT	6-1311503-670 6-1311504-670 6-1311505-670	\$371.95							●			●				●
226		CLASSROOM SELECT	6-1311480-670 6-1311477-670	\$675.95	●			●		●	●	●		●		●		
226		CLASSROOM SELECT	6-1563921-670	\$710.95	●			●			●				●	●	●	●
227		CLASSROOM SELECT	6-1594527-670	\$777.95	●			●		●	●			●				
227		CLASSROOM SELECT	6-1591926-670	\$922.95	●			●		●	●				●			
227		CLASSROOM SELECT	6-1506120-670	\$1,400.95	●			●		●	●			●	●			●
228		CLASSROOM SELECT	6-1311517-670	\$825.95	●	●	●	●	●	●	●		●	●	●	●		
229		CLASSROOM SELECT	6-2006060-670	\$642.95	●		●	●	●	●	●				●	●	●	●
229		CLASSROOM SELECT	6-2006959-670	\$678.95	●		●	●	●	●	●				●	●	●	●
229		CLASSROOM SELECT	6-2104001-670 6-2104004-670	\$443.95	●			●			●							
229		CLASSROOM SELECT	6-2006063-670 6-2006064-670	\$535.95	●	●		●			●							
230		AIS	6-2089245-670 6-2089253-670	\$755.95	●		●	●		●	●	●			●			●
230		AIS	6-2089239-670 6-2089248-670	\$650.95	●		●	●		●	●	●			●			
230		AIS	6-2090321-670	\$382.95	●		●	●			●	●			●			●
230		AIS	6-2090320-670	\$519.95	●		●	●			●	●			●			●

# Task Chair Features

Page #	Image	Brand	Item #	List Price	tilt tension control	center-tilt	knee-tilt	tilt lock	back angle adjustment	synchro-tilt	seat height adjustment	waterfall seat	forward seat tilt	back height adjustment	seat depth adjustment	width adjustable arms	arm height adjustment	integral lumbar support
231		<b>AIS</b>	6-2089255-670 6-2089236-670 6-2089244-670	\$793.95 \$793.95 \$793.95	●		●	●		●	●	●		●				
231		<b>AIS</b>	6-2089242-670	\$528.95	●		●	●		●	●	●		●		●		
231		<b>AIS</b>	6-2089237-670 6-2089251-670	\$680.95 \$680.95	●		●	●		●	●	●		●		●	●	●
232		<b>CLASSROOM SELECT</b>	6-1498095-670	\$754.95	●	●		●		●								
232		<b>CLASSROOM SELECT</b>	6-1498093-670	\$1,136.95	●	●	●	●		●								
233		<b>CLASSROOM SELECT</b>	6-1575086-670	\$1,176.95	●	●		●		●								
233		<b>CLASSROOM SELECT</b>	6-1505819-670	\$1,024.95		●				●								
233		<b>LORELL</b>	6-1504975-670	\$1,115.95	●				●	●				●	●			
233		<b>LORELL</b>	6-2048636-670	\$1,339.95	●	●	●		●	●				●	●			
234		<b>CLASSROOM SELECT</b>	6-1506130-670	\$521.95							●			●		●	●	
234		<b>CLASSROOM SELECT</b>	6-1112132-670 6-1112135-670 6-1112133-670	\$496.95 \$496.95 \$496.95						●				●	●			
235		<b>National Public Seating</b>	6-1543396-670	\$450.95						●							●	●
235		<b>National Public Seating</b>	5-2103799-670	\$499.95						●							●	●
235		<b>LORELL</b>	6-1505499-670	\$1,185.95						●				●			●	
235		<b>LORELL</b>	6-2025037-670	\$556.95						●							●	

**Classroom Select®  
Armless Multi-Task Mesh  
Back Chair**

Multi-task chair offers a breathable, black mesh back and cushioned seat upholstered in black fabric for your comfort. Functions include pneumatic seat-height adjustment from 17-1/2" to 21-3/4" H and 360° swivel. The 23-5/8" diameter, five-star nylon base is equipped 50mm dual-wheel casters with 38mm hoods for easy mobility. Weight capacity is 250 lbs.



**CLASSROOM  
SELECT**



**Classroom Select®  
Mid-Back Work Chair**

Executive mid-back work chair features a breathable mesh back and contoured seat with black upholstery. Design also offers fixed arms and a 5-star base with dual-wheel hard casters. Functions include pneumatic seat-height adjustment, 360° swivel, tilt, tilt tension and tilt lock. Capacity is 250 lbs.



Item #	Product Dimensions	Task Chair Options	Color	List Price
6-1498101-670	23 W x 25-1/2 D x 39 H in	7 10 11	Black	\$292.95

Item #	Product Dimensions	Task Chair Options	Color	List Price
6-1480183-670	27 W x 26 D x 40-1/2 H in	1 2 4 7	Black	\$347.95



**Classroom Select® Pneumatic Task Chair**

Adjustable task chair offers a molded seat and back for all-day comfort. Durable shellback and seat base deliver clean smooth lines. Height-adjustable back provides support where you need it. Functions include pneumatic seat-height adjustment, back-height adjustment, seat-depth adjustment and 360° swivel. Arms adjust in height and width. Weight capacity is 250 lbs.

Item #	Product Dimensions	Task Chair Options	Color	List Price
A 6-1311503-670	24 W x 24 D x 33 to 38 H in	7 10 13	Black	\$371.95
B 6-1311504-670	24 W x 24 D x 33 to 38 H in	7 10 13	Gray	\$371.95
C 6-1311505-670	24 W x 24 D x 33 to 38 H in	7 10 13	Blue	\$371.95

**Classroom Select® Task Seating**

Contoured molded foam seat and back provide long lasting comfort. Waterfall seat provides under thigh support. Functions include tilt tension control, center-tilt, tilt-lock, adjustable seat height, adjustable back height and adjustable arm height. Weight capacity is 225 lbs. Available in Black or Gray.

Item #	Product Dimensions	Task Chair Options	Color	List Price
6-1311480-670	26-3/4 W x 26 D x 39-1/4-42 H	1 4 6 7 8 10 12	Black	\$675.95
6-1311477-670	26-3/4 W x 26 D x 39-1/4-42 H	1 4 6 7 8 10 12	Gray	\$675.95



**Classroom Select® High-Performance Chair**

High-performance, ergonomic task chair features a contoured seat and back with built-in lumbar support as well as a sturdy metal frame. Built-in arms adjust in height from 7" to 9" and in width. Functions include pneumatic seat-height adjustment from 16-1/2" to 19", seat-glide mechanism, 360° swivel, center-tilt, tilt, tilt tension and tilt lock. With the seat-glide mechanism, seat cushion travels forward and back and then locks into position. Five-star base rolls easily on five 2" dual-wheel casters. Weight capacity is 250 lbs.

Item #	Product Dimensions	Task Chair Options	Color	List Price
6-1563921-670	27 W x 25 D x 41-1/2 H in	1 4 7 11 12 13 18	Black	\$710.95



Go to page 223 for task chair options



CLASSROOM  
SELECT 

FIVE YEAR  
5  
WARRANTY



223

Go to page 223 for task chair options

**Classroom Select® High-Back Mesh Chairs With Upholstered Seat**

Suspended upholstered seat has high density and highly resilient molded foam. Black mesh back. Built-in seat slider. Ratchet adjustable-height back. Five-position back lock with safety tilt release. Tilt tensions adjustment. Six-way adjustable arms. Designed, engineered and built in USA. Weight capacity is 250 lbs.

Item #	Product Dimensions	Task Chair Options	List Price
<b>A</b> / 6-1594527-670	26-1/3 W x 25 D x 43 H in	① ④ ⑥ ⑦ ⑩	\$498.95
<b>B</b> / 6-1594519-670	26-1/3 W x 25 D x 47 H in	① ④ ⑥ ⑦ ⑩	\$777.95

**Classroom Select® Mid-Back Chair**

Upholstered seat with either molded foam or mesh back. Adjustable height and width armrests with pivoting arm pad. Seat height and tilt tension adjustments. Tilt lock to freeze back in four positions.

Item #	Product Dimensions	Task Chair Options	Color	List Price
<b>6-1591926-670</b>	27-1/2 W x 26-1/2 D x 43 H in	① ④ ⑥ ⑦ ⑪	Black	\$922.95



**Classroom Select® High-Back Mesh Chair**

High-back mesh chair features high-strength elastic nylon mesh upholstery with a checkerboard design. Two-way adjustable armrests offer padding for comfort. Seat and back angle can adjust independently with the multi-task control. Seat-glide mechanism travels forward and back and then locks into position. The 26" diameter, five-star base is made of aluminum with a black powdercoating and is equipped with 60mm casters for easy mobility. Weight capacity is 250 lb.

Item #	Product Dimensions	Task Chair Options	Color	List Price
<b>6-1506120-670</b>	26 W x 27 1/2 D x 46 H in	① ④ ⑥ ⑦ ⑩ ⑪ ⑬	Black	\$1,400.95

CLASSROOM  
SELECT



To order a chair with a premium colored seat, simply select a high-back or mid-back frame and a seat color. Seat easily attaches to frame and ships separately.



223 Go to page 223 for task chair options

**Classroom Select® Deluxe Mesh Back Chairs**

The deluxe mesh back chair cradles you with a breathable mesh back and mesh fabric seat. The ergonomic mesh back supports the natural curvature of your back for less strain during work at the computer or meetings at your desk. Multifunction control adjusts seat and back angles independently with two levers for infinite locking within a fixed range. For more individualized comfort, arms adjust in height and width and the seat height adjusts from 17 to 21 inches. This chair also swivels 360 degrees and tilts with the pivot point located directly above the center of the chair base. Five-star nylon base is equipped with smooth rolling casters for easily moving the chair where needed. To order a deluxe mesh back chair with a premium color seat, simply select a high back or mid back frame and a premium seat color. The premium seat easily attaches to the frame. Frame and premium seat ship separately. Weight capacity is 275 lbs. Meets the CA117 fire-retardant standard.

Item #	Description	Product Dimensions	Task Chair Options	Color	List Price
A 6-1311518-670	Mid-Back w/Black Seat	25 W x 23-1/2 D x 40-1/2 H in	1 2 3 4 5 6 7 9 11 12 13	Black	\$646.95
B 6-1311517-670	High-Back w/Black Seat	28-1/2 W x 28-1/2 D x 45 H in	1 2 3 4 5 6 7 9 11 12 13	Black	\$825.95
<b>Step 1: Select Frame</b>					
C 6-2006057-670	Mid-Back Frame Only	23-1/2 Wx23-1/2 Dx 40-1/2 H in	1 2 3 4 5 6 7 9 11 12 13	Black	\$426.95
D 6-2005326-670	High-Back Frame Only	28-1/2 W x 28-1/2 D x 45 H in	1 2 3 4 5 6 7 9 11 12 13	Black	\$658.95
<b>Step 2: Select Seat Color</b>					
E 6-2005333-670	Premium Seat Only	-	-	Red	\$113.95
F 6-2005334-670	Premium Seat Only	-	-	Green	\$113.95
G 6-2005337-670	Premium Seat Only	-	-	Navy	\$113.95
H 6-2005338-670	Premium Seat Only	-	-	Ivory	\$113.95
I 6-2005329-670	Premium Seat Only	-	-	Black	\$113.95
J 6-2005330-670	Premium Seat Only	-	-	Gray	\$113.95
K 6-2005332-670	Premium Seat Only	-	-	Black Leather	\$140.95

**CLASSROOM  
SELECT**



For additional seat cushion options, select the frame only and order your fabric or leather seat separate.



**Classroom Select® Executive Mesh Back Chair**

The executive mesh-back chair features an extra thick padded seat with superior comfort. Multifunctioning mechanism features independent seat and back angle tilts, tilt lock, adjustable back height, adjustable lumbar support, tilt tension adjustment, seat slider to adjust seat depth, and a forward tilt positioning for perching. This chair is designed to fully adjust for the most comfortable sit for any user.

Item #	Description	Product Dimensions	Task Chair Options	Color	List Price
<b>A</b> / 6-2006060-670	Mid Back w/Black Seat	24 W x 24 D x 39 H in	① ③ ④ ⑤ ⑥ ⑦ ⑪ ⑫ ⑬ ⑭ ⑰ ⑱	Black	\$642.95
<b>B</b> / 6-2006959-670	High Back w/Black Seat	25 W x 24 D x 44 H in	① ③ ④ ⑤ ⑥ ⑦ ⑪ ⑫ ⑬ ⑭ ⑰ ⑱	Black	\$678.95
<b>Step 1: Select Frame</b>					
<b>C</b> / 6-2006062-670	Mid Back Frame	25 W x 24 D x 44 H in	① ③ ④ ⑤ ⑥ ⑦ ⑪ ⑫ ⑬ ⑭ ⑰ ⑱	Black	\$514.95
<b>D</b> / 6-2006960-670	High Back Frame	25 W x 24 D x 44 H in	① ③ ④ ⑤ ⑥ ⑦ ⑪ ⑫ ⑬ ⑭ ⑰ ⑱	Black	\$556.95
<b>Step 2: Select Seat Color</b>					
<b>E</b> / 6-2005391-670	Padded Seat	20-7/8 W x 20-1/8 D x 3 H in		Gray	\$145.95
<b>F</b> / 6-2005390-670	Padded Seat	20-7/8 W x 20-1/8 D x 3 H in		Navy	\$145.95
<b>G</b> / 6-2005395-670	Padded Seat	20-7/8 W x 20-1/8 D x 3 H in		Red	\$145.95
<b>H</b> / 6-2005397-670	Leather Padded Seat	20-7/8 W x 20-1/8 D x 3 H in		Black	\$165.95



**NEW**

**Classroom Select® Gaming Chair**

High-Back Gaming Chair features a sleek design, playful style and invigorating colors to support your gaming evolution. Molded cushioning on the seat and back provides contours that fit your form and need to move as you play. Vinyl upholstery on the seat and back means easy cleaning after long hours at the controls. Arms flip up and out of your way when you must lean into the action. Cushioned, upholstered pads on the arms help you relax when you can slow to cruising speed. Functions to customize your comfort include adjustable seat height from 17-7/8" to 21-7/8", tilt lock, tilt tension adjustment and 360° swivel. Roll from gaming system to gaming system on the smooth-rolling, dual-wheeled casters on the nylon base. Seat measures 20" W x 19-3/8" D. Back size is 20-7/8" W x 26-1/8" H. Weight capacity is 275 lb.

Item #	Description	Product Dimensions	Task Chair Options	Color	List Price
<b>6-2104001-670</b>	Gaming Chair	20 W x 19-3/8 D x 26 H in	① ④ ⑦	Red/Black	\$443.95
<b>6-2104004-670</b>	Gaming Chair	20 W x 19-3/8 D x 26 H in	① ④ ⑦	Blue/Black	\$443.95

**223** ... Go to page 223 for task chair options

**Classroom Select® Bucket Seat Gaming Chair**

High-back gaming chair features a racing-car style, bucket seat to keep you comfortably positioned through hours of sitting. Armrest with a soft upholstery pad flips up for added convenience. Seat-height adjustment with tilt tension allows a variety of users to sit comfortably at their desk. 360° swivel allows you to effortlessly rotate the chair for added convenience. Weight capacity is 275 lbs.

Item #	Product Dimensions	Task Chair Options	Color	List Price
<b>6-2006063-670</b>	20-1/2 W x 28 D x 47-1/2 H in	① ② ④ ⑦	Blue	\$535.95
<b>6-2006064-670</b>	20-1/2 W x 28 D x 47-1/2 H in	① ② ④ ⑦	Red	\$535.95





**223** ... Go to page 223 for task chair options

# AIS



### Affordable Interior Systems Natick High-Back Task Chair

Made for focused tasks or working in spurts, Natick is super easy to fine-tune. Seat height, seat depth, body-conforming or optional lumbar support, arm movement, and more—all are adjustable on demand. Add all that with the a synchro tilt mechanism and you get a level of comfort you never expected.

Item #	Product Dimensions	Task Chair Options	Color	List Price
6-2089245-670	26 W x 24 D x 45 H in	1 3 4 6 7 8 11 13 15 16	Black	\$755.95
6-2089253-670	26 W x 24 D x 45 H in	1 3 4 6 7 8 11 13 15 16	Gray	\$755.95

### Affordable Interior Systems Upton High-Back Task Chair

No unnecessary frills. No wonder Upton is one of our most popular office chairs. Take a seat and you'll love it even more. Ideal for conference rooms, Upton delivers sophistication above its class and comes with everything a high-performing office chair should: adjustable seat height and depth, back height, arm adjustability, and a multiple-position back lock—so you can find your fit and keep it there.

Item #	Product Dimensions	Task Chair Options	Color	List Price
6-2089239-670	25 W x 25 D x 42 H in	1 3 4 6 7 8 11 17	Black	\$650.95
6-2089248-670	25 W x 25 D x 42 H in	1 3 4 6 7 8 11 17	Black	\$650.95



### Affordable Interior Systems Revere Task Chair

Revere delivers functional adjustments at an affordable price. Its breathable black mesh back and adjustable lumbar support provide all day comfort and simple style accommodating any environment. Available through Express three-day shipping, Revere delivers speed and accessibility.

Item #	Product Dimensions	Task Chair Options	Color	List Price
6-2090321-670	25-3/4 W x 26 D x 37 H in	1 3 4 7 8 11 13 18	Black	\$382.95



### Affordable Interior Systems Essex High-Back Task Chair

With a variety of ergonomic user adjustments and breathable black mesh back, Essex task chair provides users all day comfort. Essex delivers speed at an accessible price.

Item #	Product Dimensions	Task Chair Options	Color	List Price
6-2090320-670	18 W x 23-1/2 D x 42 H in	1 3 4 7 8 11 13 18	Black	\$519.95



**Affordable Interior Systems Auburn High-Back Task Chair**

Design. Comfort. Affordability. Elevate your office or board room with this beautiful, functional, and affordable seating solution. But don't be fooled. You can afford this chair. This sleek and sophisticated chair is available at an economic price and is ideal for use in private offices and conferencing environments. The best part is that you don't have to wait long to enjoy Auburn - available in just three days through the AIS Express Seating Program. High Back: Aluminum Base, Casters, Fixed Aluminum Arms, Weight-Activated Synchro-Tilt with Automatic Tension, PVC Free Polyurethane (Anti-Microbial) Seat and Back Upholstery.

Item #	Product Dimensions	Task Chair Options	Color	List Price
6-2089255-670	18 W x 30-1/4 D x 42-1/4 H in	1 3 4 6 7 8 11	Black	\$793.95
6-2089236-670	18 W x 30-1/4 D x 42-1/4 H in	1 3 4 6 7 8 11	Gray	\$793.95
6-2089244-670	18 W x 30-1/4 D x 42-1/4 H in	1 3 4 6 7 8 11	Ivory	\$793.95



**223** Go to page 223 for task chair options

**Affordable Interior Systems Bolton Task Chairs**

No body is the same. That's why Bolton offers a robust amount of options. For the executive suite to the reception desk, in high-back and mid-back options, with a mesh back, Bolton allows users to choose the right configuration for their size, preference, and task at hand. High Back: Black Base and Frame, Casters, 4-D Arms, Weight Balanced / Automatic Tension Synchro-Tilt with Seat Depth Adj., Solid Black Back Mesh, Black Seat Upholstery. Low/Mid Back: Black Base and Frame, Casters, 1-D Arms, Center Tension Synchro-Tilt with Seat Depth Adj., Solid Black Back Mesh, Black Seat Upholstery.

Item #	Product Dimensions	Task Chair Options	Color	List Price
6-2089242-670	26 W x 24 D x 42-3/4 H in	1 3 4 6 7 8 11 13 15 16	Black	\$528.95
6-2089238-670	26 W x 24 D x 45 H in	1 3 4 6 7 8 11 13 15 16	Black	\$653.95

**Affordable Interior Systems Devens High-Back Task Chair**

Universal style. Unbeatable quality. That's what Devens is all about. Combining the latest in comfort and technology, Devens offers easy-to-use features, a weight-activated mechanism, and breathable mesh, delivering comfort and quality for long days of work.

Item #	Product Dimensions	Task Chair Options	Color	List Price
6-2089237-670	27 W x 26 D x 41-3/4 H in	1 3 4 6 7 8 11 13 15 16 18	Black	\$680.95
6-2089251-670	27 W x 26 D x 41-3/4 H in	1 3 4 6 7 8 11 13 15 16 18	Gray	\$680.95



Go to page 223 for task chair options

**Classroom Select®  
Deluxe Leather Office Chairs**

These leather office chairs feature a fully upholstered, split leather design for a rich, classic look. High- and mid-back task chairs feature stylish open loop arms and five-star nylon caster bases. Functions of the task chairs include pneumatic seat-height adjustment, 360° swivel, tilt, and tilt tension. Meets CA117 fire retardant standards. Weight capacity is 275 lbs.



Item #	Description	Product Dimensions	Task Chair Options	Color	List Price
<b>A</b> / 6-1311385-670	Leather Guest Chairs	26 W x 28 D x 35 H in		Black	\$429.95
<b>B</b> / 6-1311384-670	Mid Back	26 W x 28 D x 42-1/2 H in	① ② ④ ⑦	Black	\$556.95
<b>C</b> / 6-1311383-670	High Back	26 W x 29-1/2 D x 50 H in	① ② ④ ⑦	Black	\$581.95



**Classroom Select® Euro Design Leather Mid-back Chair**

This executive mid-back chair features a European-inspired design with stylish and comfortable bonded leather and black PVC poly fixed arms. Functions include pneumatic seat-height adjustment from 17-3/4" to 21-1/2", 360° swivel, tilt and tilt tension. 27-5/8" diameter, five-star nylon base is equipped with 50mm dual-wheel casters with 38mm hoods for easy mobility. Weight capacity is 250 lbs. Seat measures 20" W x 18-1/4" D. Back size is 20" W x 22" H.

Item #	Product Dimensions	Task Chair Options	Color	List Price
<b>6-1498095-670</b>	27-1/3W x 28-1/3D x 43-1/2H in	① ② ④ ⑦	Black	\$754.95

**Classroom Select® Modern Executive High Back Leather Chair**

This executive, high-back leather chair offers a modern, clean design with comfortable, built-in lumbar support. Chromed-metal arms are equipped with leather pads for style and comfort. Functions include pneumatic seat-height adjustment from 18-1/4" to 21-1/4", 360° swivel, tilt, knee tilt, tilt tension and tilt lock. 27-5/8" diameter, polished aluminum, 5-star base is equipped with 50mm hooded, dual-wheel casters with 38mm hoods for easy chair movement. Weight capacity is 275 lbs. Seat measures 20-1/2" W x 19" D. Back size is 20" W x 27-1/4" H. High-back chair meets or exceeds ANSI/BIFMA standards.

Item #	Product Dimensions	Task Chair Options	Color	List Price
<b>6-1498093-670</b>	27-1/3W x 28-3/4D x 48-1/2H in	① ② ③ ④ ⑦	Black	\$1,136.95



**Classroom Select® Leather Chair**

Chair features bonded leather upholstery over thickly cushioned seating for deluxe comfort and style. Fixed chrome steel arms also feature soft upholstery pads. Functions include pneumatic seat-height adjustment from 18-1/2" to 22-1/2", 360° swivel, tilt, tilt tension and tilt lock. 27-7/8" diameter spider base is made of steel with a shiny chrome finish and is equipped with 50mm hooded, dual-wheel casters for easy chair movement. Weight capacity is 250 lbs.

Item #	Description	Product Dimensions	Task Chair Options	List Price
<b>A</b> / 6-1498087-670	High-Back Task Chair	27-1/2W x 29-1/2D x 46-1/2H in	① ② ④ ⑦	\$766.95
<b>B</b> / 6-1498086-670	Sled Base Guest Chair	35-3/8 W x 26-1/8 D x 35 H in		\$638.95



CLASSROOM  
SELECTFIVE YEAR  
5  
WARRANTY**Classroom Select®  
Big & Tall Leather Chair**

This big & tall chair features bonded leather upholstery, a 500 lb. weight capacity and UltraCoil comfort with coiled comfort springs. This advanced foam layering system is designed to offer deliberate, unique and zone-based support for a more enjoyable seating experience. Functions to customize position include pneumatic seat height adjustment from 19-7/8" to 23-5/8", 360° swivel, tilt and tilt tension. Fixed, chromed metal arms feature upholstered pads.



Item #	Product Dimensions	Task Chair Options	Color	List Price
6-1575086-670	30-1/4 W x 23 D x 45-3/4 H in	①②④⑦	Black	\$1,176.95



A



B

CLASSROOM  
SELECTFIVE YEAR  
5  
WARRANTY**Classroom Select® Big & Tall Guest Chair**

With leather-upholstered, padded seat and back, this big & tall guest chair offers luxurious comfort for your waiting room and a 500 lb. capacity to support more guests. Sturdy construction features a plywood core for the seat and back, black plastic arm caps and metal frame with a powder coat finish. Sled base with stabilizing feet offers a balanced, supportive foundation for your guests.

Item #	Description	Product Dimensions	List Price
6-1565548-670	Fabric Upholstered Guest Chair	26-1/4 W x 27-1/4 D x 35 H in	\$795.95
6-1565549-670	Big & Tall Black Leather	26-1/4 W x 27-1/4 D x 35 H in	\$861.95

CLASSROOM  
SELECTFIVE YEAR  
5  
WARRANTY**Classroom Select® Big & Tall  
Double Cushion Leather Chair**

This executive swivel chair features double-plush cushions on the extra-wide seat, and back and leather upholstery for a professional look and your comfort. Durable construction with reinforced leather offers an enhanced weight capacity of 350 lbs.



Item #	Product Dimensions	Task Chair Options	Color	List Price
6-1505819-670	31 W x 31-1/2 D x 47 H in	②⑦	Black	\$1,024.95

LORELL®

**Lorell Big & Tall Chair**

Supports weight up to 450lbs and offers the bonded leather upholstery on the thickly cushioned seat and back. Chromed steel arms with soft pads. The 29" diameter five-star base is made of shiny chromed steel for durability and is equipped with casters for easy mobility. Comfort features include pneumatic seat-height adjustment, 360-degree swivel, normal tilt with lock and tilt tension adjustment. Covered by Lorell Limited 5-Year Warranty.

For  
Big  
&  
Tall  
450 lbs.

Item #	Product Dimensions	Task Chair Options	Color	List Price
6-1504975-670	22 W x 30 D x 47 H in	①⑤⑥⑩⑪	Black	\$1,115.95

LORELL  
5  
YEAR  
LIMITED  
WARRANTY

LORELL®

**Lorell Big & Tall 350 lb. Chair**

Big & Tall Mesh Back Chair features a high weight capacity and a breathable mesh back with built-in lumbar support. Additional features include pneumatic seat-height adjustments from 17 3/4" to 19 5/8", back-height adjustment, seat-glide mechanism, 360-degree swivel, tilt, and tilt tension. Polyurethane-padded arms pivot and adjust in height for optimized comfort. Covered by Lorell Limited 5-Year Warranty.

Item #	Product Dimensions	Task Chair Options	Color	List Price
6-2048636-670	29-1/2 W x 27-1/2 D x 44 H in	①②③⑤⑥⑩⑪⑭	Black	\$1,339.95



223

Go to page 223 for  
task chair options



**FIVE YEAR  
WARRANTY**

**223**

Go to page 223 for task chair options

**CLASSROOM  
SELECT**

**Classroom Select® ErgoMesh Series Mid-Back Stool**

Mid-back stool offers ratchet back and a comfortable, breathable mesh back. Mesh is made of high-strength elastic nylon. Ergonomically designed mid-back is perfect for the natural curvature of a person's back. Design also features a cushioned fabric seat and chrome foot ring to heighten your comfort. Included arms adjust in height from 32" to 42-1/2" and in width from 24" to 26" to suit your needs. Other functions include pneumatic seat-height adjustment from 25" to 35-3/8", 360° swivel and back-height adjustment. 25-1/2" diameter, five-star steel base has a polypropylene cap and casters for easy mobility. Seat size is 20" W x 18-3/4" D. Back measures 20" W (at the widest portion) x 19-3/4" H. Weight capacity is 250 lbs.

Item #	Product Dimensions	Task Chair Options	Color	List Price
6-1506130-670	26 W x 23-5/8 D x 53 H in	7 10 12 13 17	Black	\$521.95



**FIVE YEAR  
WARRANTY**

**CLASSROOM  
SELECT**

**Classroom Select® Millenia Task Stools**

Molded seat and back. Adjustable-height stool with adjustable chrome footring. 275 lb. capacity.

Item #	Product Dimensions	Task Chair Options	Color	List Price
6-1112132-670	24 W x 24 D x 50-1/2 H in	7 10 11	Black	\$496.95
6-1112135-670	24 W x 24 D x 50-1/2 H in	7 10 11	Gray	\$496.95
6-1112133-670	24 W x 24 D x 50-1/2 H in	7 10 11	Blue	\$496.95



**LIMITED  
LIFETIME  
WARRANTY**

**CLASSROOM  
SELECT**

**Classroom Select® Pneumatic Stool**

The Classroom Select® Pneumatic Stool is a great, cost-effective option for any environment, especially in ones where space is limited. This 360 degree swivel stool features a 16" round seat cushion, in an easy to clean vinyl fabric. A durable chrome finish pneumatic lift base offers height adjustments from 17" to 22-1/2". This stool features 2" dual-wheel casters perfect for any floor surface.

Item #	Seat Height	Fabric Color	Frame Color	List Price
6-2051242-670	17 - 22-1/2 in	Black	Chrome	\$199.95



Go to page 223 for task chair options



### National Public Seating® Kangaroo Stool

Kangaroo Stool provides unique strength and function for your industrial seating demands, yet designed with beauty and grace in mind. This model includes the addition of arms, which enhances the stool, offering added support and comfort. Heavy duty 1-1/4 inch thick Polyurethane seat has a waterfall edge for plush comfort and functionality, and ribbed ventilation design allows air circulation while seated. Polyurethane material is resistant to chemicals and punctures, and cleans easily.

Item #	Description	Product Dimensions	Task Chair Options	Color	List Price
5-2103798-670	Short Armless Stool	26 W x 26 D x 27 - 37 H in	<b>NEW</b>	(7) 13 18	Black \$397.95
6-1543396-670	Tall Armless Stool	26 W x 26 D x 38 - 48 H in		(7) 13 18	Black \$450.95
5-2103799-670	Short w/Arms Stool	26 W x 26 D x 27 - 37 H in	<b>NEW</b>	(7) 13 18	Black \$499.95
5-2103801-670	Tall w/Arms Stool	26 W x 26 D x 38 - 48 H in	<b>NEW</b>	(7) 13 18	Black \$540.95



### LORELL® Lorell Drafting Stool

Drafting stool offers a breathable mesh back and upholstered cushioned seat to enhance comfort. Padded arms adjust in height and width for a position that suits your needs. Adjustable chrome foot ring. Additional features include pneumatic seat-height adjustment, back-height adjustment and 360-degree swivel. Black, five-star nylon base is equipped with smooth-rolling casters for easy mobility. Weight capacity of 275 lbs. Meets or exceeds BIFMA standards. Covered by Lorell-Limited 5-Year Warranty.

Item #	Product Dimensions	Task Chair Options	Color	List Price
6-1505499-670	27 W x 25 D x 48 H in	(7) 10 13	Black	\$1,185.95

### LORELL® Lorell SOHO Mid-Back Stool

SOHO Mid-Back Stool with foot ring features a mesh back and fabric upholstery seat. Mesh back is breathable and flexible. It meets your needs with height-adjustable arms and seat. Stool also swivels and rolls on smooth-rolling casters. Weight capacity of 275 lbs. Covered by Lorell Limited 5-Year Warranty.

Item #	Product Dimensions	Task Chair Options	Color	List Price
6-2025037-670	52 H x 27 W x 27 D	(7) 13	Black	\$556.95







**Lorell Tempered Glass Chairmat**

Tempered glass chair mat features a scratch-resistant design to protect your flooring while offering a smooth surface for your chair. Its durable material safely supports up to 1,000 pounds. Easy-to-clean material wipes down quickly for simple upkeep. Chair mat is designed for any floor type, including high-pile or low-pile carpet, hardwood, marble, and more.



Item #	Product Dimensions	List Price
5-2005372-670	36 W x 46 D in	\$135.95
5-2005365-670	44 W x 50 D in	\$179.95
5-2005366-670	48 W x 60 D in	\$225.95



**Lorell Studded Polycarbonate Chairmat**

This polycarbonate chair mat with no lip can be used on all carpets. Its durable surface protects floors from chair scuffs and caster damage. Its exceptional clarity lets the beauty of the floor show through while its easy-glide rolling surface provides effortless chair mobility. This mat features a straight edge and is studded for a strong grip without piercing or damaging your carpet backing.

Item #	Product Dimensions	List Price
5-1505955-670	36 W x 48 D in	\$157.95
5-1505956-670	45 W x 53 D in	\$225.95
5-1505957-670	46 W x 60 D in	\$260.95



**Lorell Polycarbonate Chairmat**

This chair mat with no lip is designed for hard floors including wood, vinyl and tile. Its durable surface protects floors from chair scuffs and caster damage. Its exceptional clarity lets the beauty of the floor show through, while its easy-glide rolling surface provides effortless chair mobility. This mat features a straight edge and is non-studded for smooth, nonslip placement on hard floors.



Item #	Product Dimensions	List Price
5-1505958-670	36 W x 48 D in	\$174.95
5-1505959-670	45 W x 53 D in	\$209.95
5-1505960-670	46 W x 60 D in	\$219.95
5-1504921-670	60 W x 60 D in	\$299.95
5-1504922-670	60 W x 79 D in	\$387.95



### Lorell Vinyl Chairmats

Lorell Chairmat features a nonstudded design made specifically for hard floor and low-pile surfaces. Sturdy, 1/16 inch thick material protects wood, tile and vinyl flooring from wear and tear caused by chair casters. Easy-glide rolling surface provides effortless mobility. Lightly textured top surface is slip-resistant and scuff-resistant. Design also includes a straight edge. Free and Clear formula produces an exceptionally clear vinyl mat that is nonphthalate, noncadmium and BPA-free.



Item #	Description	Product Dimensions	List Price
5-1506082-670	Hard Floor Chair Mat	36 W x 48 D in	\$121.95
5-1506077-670	Low-Pile Chair Mat	36 W x 48 D in	\$169.95
5-1506083-670	Hard Floor Chair Mat	45 W x 53 D in	\$147.95
5-1506078-670	Low-Pile Chair Mat	45 W x 53 D in	\$272.95
5-1506792-670	Hard Floor Chair Mat	46 W x 60 D in	\$168.95
5-1506079-670	Low-Pile Chair Mat	46 W x 60 D in	\$281.95



PRODUCT CERTIFIED FOR LOW CHEMICAL EMISSIONS: UL COMF63 UL 2818



### Deflect-o® Supermat Chair Mats

Tough, vinyl construction lets the beauty of carpeting show through while providing a smooth riding surface. Safeguards medium pile carpet. Scuff resistant, textured top surface. The mats have hundreds of teeth to grip the mat to the carpeting. Free+Clear™ non-phthalate, non-cadmium, vinyl formula provides an exceptionally clear, durable mat. Ships rolled.

Item #	Description	Product Dimensions	List Price
5-633329-670	Rectangle With Lip	36 W x 48 D x 1/8 H in	\$148.95
5-633330-670	Rectangle With Lip	45 W x 53 D x 1/8 H in	\$164.95
5-1137373-670	Rectangle With Lip	46 W x 60 D x 1/8 H in	\$224.95
5-1442159-670	Rectangle No Lip	45 W x 53 D x 1/8 H in	\$163.95
5-633331-670	Rectangle No Lip	46 W x 60 D x 1/8 H in	\$255.95
5-1442161-670	Workstation	60 W x 66 D x 1/8 H in	\$428.95



### Deflect-o Sit-Stand Chairmat

Ergonomic sit-stand chairmat has a dual purpose. It has been designed for use with adjustable-height sit-stand workstations. The mat combines the ease of chair mobility with the comfort of anti-fatigue support foam. It offers a smooth transition from sitting to standing.

Item #	Product Dimensions	List Price
5-1586935-670	45 W x 53 D x 3/8 H in	\$715.95
5-1586937-670	46 W x 60 D x 3/8 H in	\$750.95



QUICKSHIP Items ship within 24 hrs, 48 hrs, 1 or 2 weeks as indicated when the factory distribution center receives the order.



See Shipping & Handling terms for details.



Cherry Mahogany

**Lorell Panel End Hardwood Veneer Bookcases**

High-quality, veneer bookcases feature a vintage square design. The bottom shelf is fixed. The other solid, 3/4" thick shelf is adjustable on 1- 3/4" centers with pinhole attachments. Two-shelf bookcase has a laminate finish on the back's interior and an unfinished back side. Each shelf holds up to 110 lbs. ARB compliant. Covered by Lorell Limited 5-Year Warranty.

Item #	Product Dimensions	Number of Shelves	Number of Adjustable Shelves	Color	List Price
6-1112060-670	36 W x 12 D x 30 H in	2	0	Mahogany	\$349.95
6-1311619-670	36 W x 12 D x 30 H in	2	0	Cherry	\$349.95
6-1311375-670	36 W x 12 D x 36 H in	3	2	Mahogany	\$422.95
6-1311620-670	36 W x 12 D x 36 H in	3	2	Cherry	\$422.95
6-1112066-670	36 W x 12 D x 48 H in	4	3	Mahogany	\$515.95
6-1311621-670	36 W x 12 D x 48 H in	4	3	Cherry	\$515.95
6-1112087-670	36 W x 12 D x 60 H in	5	4	Mahogany	\$618.95
6-1311622-670	36 W x 12 D x 60 H in	5	4	Cherry	\$618.95
6-1311376-670	36 W x 12 D x 72 H in	6	5	Mahogany	\$767.95
6-1311623-670	36 W x 12 D x 72 H in	6	5	Cherry	\$767.95
6-1311624-670	36 W x 12 D x 84 H in	6	5	Cherry	\$783.95



Walnut Walnut Mahogany Cherry Mahogany Weathered Charcoal Espresso

**Lorell Laminated Bookcases**

Sturdy bookcase offers high-quality laminate construction and a contemporary design. Shelves are 3/4" thick and adjust in 1" increments, and made with thermally fused, mahogany laminate for long lasting use. The visible, one piece backing behind the shelves is made with matching laminate. Both sides are finished. Bookcase feature adjustable shelves, one fixed bottom shelf, square edges, and adjustable feet. Each shelf holds up to 75 lbs. Greenguard Certified. Covered by Lorell Limited 5-Year Warranty.

Item #	Product Dimensions	Number of Shelves	Number of Adjustable Shelves	Color	List Price
6-1575452-670	36 W x 12 D x 29-1/2 H in	2	1	Mahogany	\$296.95
6-1575453-670	36 W x 12 D x 29-1/2 H in	2	1	Cherry	\$296.95
6-1575454-670	36 W x 12 D x 29-1/2 H in	2	1	Walnut	\$296.95
6-1575455-670	36 W x 12 D x 36 H in	3	2	Mahogany	\$336.95
6-1575456-670	36 W x 12 D x 36 H in	3	2	Cherry	\$336.95
6-1575457-670	36 W x 12 D x 36 H in	3	2	Walnut	\$336.95
6-2051263-670	36 W x 12 D x 36 H in	3	2	Charcoal	\$336.95
6-2048529-670	36 W x 12 D x 36 H in	3	2	Espresso	\$336.95
6-1575458-670	36 W x 12 D x 48 H in	4	3	Mahogany	\$389.95
6-1575459-670	36 W x 12 D x 48 H in	4	3	Cherry	\$389.95
6-1575460-670	36 W x 12 D x 48 H in	4	3	Walnut	\$389.95
6-2028031-670	36 W x 12 D x 48 H in	4	3	Weathered Charcoal	\$389.95
6-2024464-670	36 W x 12 D x 48 H in	4	3	Espresso	\$389.95
6-1575461-670	36 W x 12 D x 60 H in	5	4	Mahogany	\$468.95
6-1575462-670	36 W x 12 D x 60 H in	5	4	Cherry	\$468.95
6-1575463-670	36 W x 12 D x 60 H in	5	4	Walnut	\$468.95
6-1575465-670	36 W x 12 D x 72 H in	6	5	Cherry	\$523.95
6-1575466-670	36 W x 12 D x 72 H in	6	5	Walnut	\$523.95
6-2027579-670	36 W x 12 D x 72 H in	6	5	Weathered Charcoal	\$523.95
6-2025341-670	36 W x 12 D x 72 H in	6	5	Espresso	\$523.95



Height includes 6" casters



### Sandusky Lee® Welded Steel Mobile Bookcases

Features fully adjustable shelves that adjust on 1" centers plus raised bottom shelf. Welded steel construction. Heavy duty caster base with casters, 2 locking. Shipped assembled except for placing bookcase into base. Meets ANSI/BIFMA shelf standards. Please specify color when ordering.



PRODUCT CERTIFIED FOR LOW CHEMICAL EMISSIONS: UL.COM/CGG UL 2818

Item #	Product Dimensions	Number of Shelves	Number of Adjustable Shelves	Color	List Price
6-1362562-670	36 W x 18 D x 48 H in	3	2	Specify	\$910.95
6-1362564-670	36 W x 18 D x 78 H in	5	4	Specify	\$1,124.95



#### Welded Steel Bookcase Colors

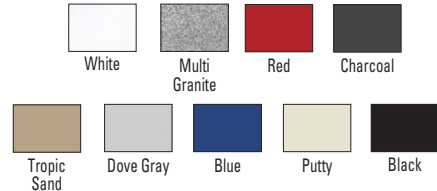

PRODUCT CERTIFIED FOR LOW CHEMICAL EMISSIONS: UL.COM/CGG UL 2818



1 Week Quick Ship on Black, Dove Gray, Putty, and Sand

### Sandusky Lee® Elite Welded Steel Bookcases

Durable, steel bookcases have fully adjustable shelves that adjust on 1" centers plus raised bottom shelf. Welded steel construction. Powder coat finish. Shipped assembled. Meets ANSI/BIFMA standards. Please specify color choice when ordering.

Item #	Product Dimensions	Number of Shelves	Number of Adjustable Shelves	Color	List Price
6-1442692-670	34-1/2 W x 12-5/8 D x 42 H in	3	2	Specify	\$549.95
6-1442695-670	34-1/2 W x 12-5/8 D x 72 H in	5	4	Specify	\$699.95
6-1362486-670	36 W x 18 D x 42 H in	3	2	Specify	\$644.95
6-1362490-670	36 W x 18 D x 72 H in	5	4	Specify	\$867.95
6-1362492-670	36 W x 18 D x 84 H in	6	5	Specify	\$1,068.95



QUICKSHIP Items ship within 24 hrs, 48 hrs, 1 or 2 weeks as indicated when the factory distribution center receives the order.



See Shipping & Handling terms for details.

### Classroom Select® Vertical File

Commercial-grade vertical file features two high-sided drawers that accommodate letter-size, hanging file folders without additional accessories. Three-piece slide suspension allows maximum drawer extension. Steel ball bearings provide smooth, quiet drawer performance. Vertical file also features a core removable lock, adjustable wire followers, and heavy-duty steel construction. Meets or exceeds applicable ANSI/BIFMA standards.



CLASSROOM  
SELECT 



PLEASE SPECIFY COLOR CHOICE



Item #	Description	Product Dimensions	Color	List Price
<b>Letter</b>				
6-1447114-670	Letter 2-Drawer	15 W x 25 D x 29 H in	Specify	\$232.95
6-1447115-670	Letter 4-Drawer	15 W x 25 D x 52 H in	Specify	\$385.95
<b>Legal</b>				
6-1482839-670	Legal 2-Drawer	18 W x 25 D x 29 H in	Specify	\$249.95
6-1482840-670	Legal 4-Drawer	18 W x 25 D x 52 H in	Specify	\$431.95



### Classroom Select® Lateral File

Lateral files feature hanging file rails for side-to-side filing in letter size, legal size, or A4 size. Design features a core removable lock, dual locking bars, full-width pull, heavy-duty ball-bearing slide suspension, reinforced base, and four adjustable leveling guides. Interlock system prohibits the extension of more than one drawer at a time. Counterweight prevents tipping. Lateral file meets or exceeds applicable ANSI/BIFMA standards.



PRODUCT CERTIFIED FOR LOW CHEMICAL EMISSIONS: UL COMPOS 500005 UL 2818

Classroom Select®  
Lateral File Bright Colors



Item #	Product Dimensions	Color	List Price
<b>2-Drawer Standard Color</b>			
6-1496389-670	30 W x 18 D x 27 H in	Specify	\$538.95
6-1496390-670	36 W x 18 D x 27 H in	Specify	\$577.95
6-1496391-670	42 W x 18 D x 27 H in	Specify	\$604.95
<b>3-Drawer Standard Color</b>			
6-1496611-670	30 W x 18 D x 40 H in	Specify	\$671.95
6-1496613-670	36 W x 18 D x 40 H in	Specify	\$716.95
6-1496615-670	42 W x 18 D x 40 H in	Specify	\$750.95

Item #	Product Dimensions	Color	List Price
<b>4-Drawer Standard Color</b>			
6-1496617-670	30 W x 18 D x 52 H in	Specify	\$782.95
6-1496619-670	36 W x 18 D x 52 H in	Specify	\$834.95
6-1496621-670	42 W x 18 D x 52 H in	Specify	\$872.95
<b>5-Drawer Standard Color</b>			
6-1496623-670	30 W x 18 D x 67 H in	Specify	\$1,056.95
6-1496625-670	36 W x 18 D x 63 H in	Specify	\$1,120.95
6-1496627-670	42 W x 18 D x 63 H in	Specify	\$1,173.95
<b>2-Drawer Bright Color</b>			
6-5008418-670	36 W x 18-1/2 D x 28 H in	Specify	\$585.95
<b>3-Drawer Bright Color</b>			
6-5008417-670	36 W x 18-1/2 D x 40 H in	Specify	\$740.95
<b>4-Drawer Bright Color</b>			
6-5008419-670	36 W x 18-1/2 D x 52-1/2 H in	Specify	\$843.95
<b>5-Drawer Bright Color</b>			
6-5008416-670	36 W x 18-1/2 D x 67-1/2 H in	Specify	\$1,142.95



### Classroom Select® Laminate Top for Lateral Filing Cabinets

Add a color coordinating laminate top to your Classroom Select® Lateral File Cabinet for an additional work surface or collaboration area. All edge bands are 3mm in black.

Item #	Product Dimensions	Top Color	List Price
6-5003641-670	30 W x 18 D x 1 H in	Specify	\$253.95
6-5003640-670	36 W x 18 D x 1 H in	Specify	\$272.95
6-5003639-670	42 W x 18 D x 1 H in	Specify	\$307.95



Refer to pages 60-61 for color options.



PRODUCT CERTIFIED FOR LOW CHEMICAL EMISSIONS: UL.COM/IGG UL 2818



**Lorell Lateral File Combo Units**

The Lorell Lateral File Combo Unit combines a lateral file, a bookcase, and a printer stand into one design. File drawer accepts letter, legal or A4 size hanging file folders. The drawers also feature full-width pulls and precision steel ball-bearing suspension. This combo is also equipped with adjustable leveling guides for stability of uneven surfaces. Meets or exceeds ANSI/BIFMA standards. Contains 28% recycled materials. Greenguard Gold Certified. Covered by Lorell Limited Lifetime Warranty.



2 Drawer



3 Drawer

Item #	Description	Product Dimensions	Color	List Price
6-1505830-670	2-Drawer 2 Shelf File	36 W x 18-5/8 D x 60 H in	Black	\$2,163.95
6-1505829-670	3-Drawer 2 Shelf File	36 W x 18-5/8 D x 60 H in	Black	\$2,163.95



Putty



Black



**Lorell Fortress Series Roll-Out Shelf Files with Receding Drawer Fronts**

Lorell Receding Lateral file with roll-out shelves offers drawers with heavy-duty, three-piece, ball-bearing slide suspension for smooth drawer movement. The top three drawers have receding fronts and roll-out shelves. The bottom drawer has a fixed front. Hangrails are included which can accommodate side-to-side filing of letter, legal or A4 size folders. Four adjustable leveling glides are included for stabilization and reinforced double-base construction. Does not include dividers. Meets/exceeds applicable ANSI/BIFMA standards. Contains 28% recycled materials. Greenguard Gold Certified. Limited Lifetime Warranty.

Item #	Description	Product Dimensions	Color	List Price
6-1505501-670	4-Drawer Lateral File	36 W x 18-5/8 D x 52-1/2 H in	Putty	\$2,035.95
6-1505505-670	4-Drawer Lateral File	42 W x 18-5/8 D x 52-1/2 H in	Putty	\$2,162.95
6-1505504-670	5-Drawer Lateral File	36 W x 18-5/8 D x 68-3/4 H in	Black	\$2,407.95
6-1505503-670	5-Drawer Lateral File	36 W x 18-5/8 D x 68-3/4 H in	Putty	\$2,407.95
6-1505508-670	5-Drawer Lateral File	42 W x 18-5/8 D x 68-3/4 H in	Black	\$2,981.95
6-1505507-670	5-Drawer Lateral File	42 W x 18-5/8 D x 68-3/4 H in	Putty	\$2,981.95





### FireKing® Insulated Filing Cabinets

All FireKing® files carry Underwriters' Laboratories Class 350-one or two hour "Record Protection Equipment classified as to Fire and Impact Resistance." Insulation between drawers makes each drawer a separate, fireproof unit. Drill and pick resistant UL listed high security key lock (standard key lock on Turtle® files). Manufacturer's lifetime warranty on all parts.

**⚠️ WARNING: This product can expose you to chemicals including Silica, which is known to the State of California to cause cancer and Cadmium, which is known to the State of California to cause birth defects or other reproductive harm. For more information go to [www.P65Warnings.ca.gov](http://www.P65Warnings.ca.gov).**

Insulation is 100% gypsum, oven-dried to reduce moisture to less than 1/2%-eliminating dampness and mildew and is reinforced by a 1" x 2" lattice made of 14 gauge, galvanized welded-steel wire.

Field-replaceable steel panels are up to 50% thicker than other makes of fireproof files.

Finish is an environmentally friendly, electrostatic powder coating up to three times thicker than conventional painted files, applies to all sides, including bottom.

Drawer bodies are built with high sides for use with hanging folders no additional frames are required.

Drawer heads are formed of welded steel and filled with fireproof gypsum insulation.

Drawer LOCKS on all files provide general locking of all drawers through UL-listed high-security locks.

Drawer PULLS are surface mounted to allow for extra insulation inside the drawer heads.

Insulation between all drawers makes each one a separate insulated container.

Two-position drawer catch allows access to certain drawers while others remain locked.

Drawer suspensions are maintenance-free and guaranteed for life.



### FireKing® 25R - 25" Deep Vertical Files



Item #	Description	Product Dimensions	Ship Weight	Color	List Price
6-1363515-670	Letter 2 Drawer	17-3/4 Wx25-1/16 Dx27-3/4 H in	287 lbs	Specify	\$3,586.95
6-1363518-670	Legal 2 Drawer	20-13/16Wx25-1/16Dx27-3/4 H in	326 lbs	Specify	\$3,647.95
6-1363526-670	Letter 4 Drawer	17-3/4 Wx25-1/16Dx 52-3/4 H in	508 lbs	Specify	\$5,734.95
6-1363523-670	Legal 4 Drawer	20-3/4 Wx25-1/16 Dx52-3/4 H in	551 lbs	Specify	\$5,822.95

### Icon Key:

- UL Explosion Rated - 2000°F
- UL Impact Rated to withstand the impact of a 30 ft. drop
- 1 hour UL rating up to 1700°F
- ETL Verified water resistance from sprinklers and fire hoses

### FireKing® Classic-31" Deep Vertical File



Item #	Description	Product Dimensions	Ship Weight	Color	List Price
6-1363514-670	Letter 2 Drawer	17-3/4 Wx31-9/16 Dx27-3/4 H in	348 lbs	Specify	\$4,489.95
6-1363516-670	Legal 2 Drawer	20-13/16Wx31-9/16 Dx27-3/4H in	383 lbs	Specify	\$6,876.95
6-1363520-670	Letter 3 Drawer	17-3/4 Wx31-9/16 Dx40-1/4 H in	476 lbs	Specify	\$6,360.95
6-1363519-670	Legal 3 Drawer	20-13/16Wx31-9/16Dx40-1/4 H in	526 lbs	Specify	\$6,488.95
6-1363525-670	Letter 4 Drawer	17-11/16Wx31-9/16Dx52-3/4 H in	603 lbs	Specify	\$6,913.95
6-1363522-670	Legal 4 Drawer	20-13/16Wx31-9/16Dx52-3/4 H in	664 lbs	Specify	\$7,030.95

### FireKing® UL Class 350 Two-Hour with Impact - 32" Deep Vertical Files

Item #	Description	Product Dimensions	Ship Weight	Color	List Price
6-1363513-670	Letter 2 Drawer	19 W x 31-3/16 D x 29-1/2 H in	477 lbs	Specify	\$6,025.95
6-1363517-670	Legal 2 Drawer	21-5/16 Wx32-1/16 Dx29-7/8H in	548 lbs	Specify	\$6,243.95
6-1363524-670	Letter 4 Drawer	19 Wx31-3/16 Dx56-3/16 H in	957 lbs	Specify	\$9,324.95
6-1363521-670	Legal 4 Drawer	21-5/16 Wx32-1/16 Dx57 H in	1021 lbs	Specify	\$9,459.95



### FireKing® Patriot™ Fire File

The Patriot file is economically priced for today's economy yet features FireKing's signature integrity and high quality. Features include the prestigious UL class 350° one hour fire rating, field replaceable panels, recessed handles and your choice of two colors; Black and Parchment. The Patriot is backed by FireKing's 10 year limited warranty. The Patriot Files are available in black or parchment only. **⚠️ WARNING: This product can expose you to chemicals including Silica, which is known to the State of California to cause cancer and Cadmium, which is known to the State of California to cause birth defects or other reproductive harm. For more information go to [www.P65Warnings.ca.gov](http://www.P65Warnings.ca.gov).**



Item #	Description	Product Dimensions	Ship Weight	Color	List Price
6-1444801-670	2 drawer Letter/Legal	17-3/4 Wx25-1/16 Dx27-3/4 H in	287 lbs	Specify	\$2,760.95
6-1444799-670	2 drawer Letter	17-3/4 Wx31-9/16 Dx27-3/4 H in	348 lbs	Specify	\$3,124.95
6-1444798-670	2 drawer Legal	20-3/16Wx31-9/16Dx27-3/4 H in	383 lbs	Specify	\$3,328.95
6-1444800-670	4-Drawer Letter/Legal	18 W x 25 D x 53 H in	508 lbs	Specify	\$4,555.95
6-1444797-670	4-Drawer Letter	18 W x 32 D x 53 H in	603 lbs	Specify	\$5,070.95
6-1444796-670	4-Drawer Legal	21 W x 32 D x 53 H in	664 lbs	Specify	\$5,219.95



### Fire King Colors

PLEASE SPECIFY COLOR CHOICE



\* Colors not available for quick ship

## DESKSIDE SHREDDERS



Brand	HSM	HSM	HSM	HSM	HSM
Model	shredstar X20	shredstar X17	shredstar X14	shredstar X12	shredstar X10
Item Number	9-2023919-670	9-2023918-670	9-2023917-670	9-2023913-670	9-2023912-670
List Price	\$600.95	\$529.95	\$475.95	\$391.95	\$251.95
Cut Type/Sheet Capacity	Cross-Cut / 20	Cross-Cut / 17	Cross-Cut / 14	Cross-Cut / 12	Cross-Cut / 10
Shred Size	5/32" x 1 7/16"	5/32" x 1 7/16"	5/32" x 1 7/16"	5/32" x 1 7/16"	3/16" x 1 1/8"
Shreds					
Shredder Type	Office	Office	Small Office	Small Office	Small Office
Run Time	15 on / 30 off	15 on / 30 off	15 on / 30 off	15 on / 30 off	7 on / 45 off
Recommended Users	1-5	1-5	1-5	1-5	1-2
Throat Width	9"	9"	9"	9"	8.7"
Jam Prevention Feature	Anti-Jam Technology	Anti-Jam Technology	Anti-Jam Technology	Anti-Jam Technology	Anti-Jam Technology
Quiet Operation Feature	Quiet Operation	Quiet Operation	Quiet Operation	Quiet Operation	Quiet Operation
Wastebin Capacity (gallons)	6.9	6.9	6.1	6.1	5.3
Wastebin Full Indicator	Yes	Yes	Yes	Yes	Yes
Size (W x D x H)	15.6" x 11" x 21.7"	15.6" x 11" x 21.7"	15.6" x 11" x 21.7"	15.6" x 11" x 21.7"	13.6" x 9.6" x 18.3"
Mfr. Warranty (machine/cutter)	2-year parts/LifeTime	2-year parts/LifeTime	2-year parts/LifeTime	2-year parts/LifeTime	2-year parts/LifeTime

### ACCESSORIES

Item Number	9-1384650-670	9-1384650-670	9-1384650-670	9-1384650-670	9-1384650-670
Description	ShredderOil 16oz	ShredderOil 16oz	ShredderOil 16oz	ShredderOil 16oz	ShredderOil 16oz
List Price	\$19.95	\$19.95	\$19.95	\$19.95	\$19.95



**CLASSROOM  
SELECT**

**Classroom Select® Storage Organizers**

The organizer is made of solid birch plywood with corrugated cardboard shelves. Horizontal slots provide space for mail, notes and messages of all sorts. Colored paper in cubbies sold separately.

Item #	Product Dimensions	Number of Compartments	List Price
5-1491764-670	29 W x 12 D x 12-1/2 H in	12	\$120.95
5-1491766-670	29 W x 12 D x 24 H in	24	\$171.95
5-1491768-670	29 W x 12 D x 35-1/2 H in	36	\$241.95

**CHILDCRAFT®**  
A School Specialty® Exclusive

ASSEMBLED  
IN U.S.A.  
  
WITH GLOBAL  
MATERIALS

GREENGUARD  
GOLD

PRODUCT CERTIFIED  
FOR LOW CHEMICAL  
EMISSIONS:  
UL.COM/IGG  
UL 2918

LIMITED  
**LIFETIME**  
WARRANTY



**Childcraft® 30-Cubby Horizontal Mailbox Organizer**

Removable shelves let you configure each shelf for flexible storage options and easy cleaning. Can be set on a tabletop or mounted on a wall; mounting hardware and instructions included. Assembled.

Item #	Description	Product Dimensions	List Price
6-072000-670	30-Cubby Mailbox	47-1/4 W x 11-1/2 D x 26 H in	\$843.95



**Childcraft® Vertical Mailbox Storage Unit**

Vertical mailbox unit features 30 slots and removable dividers for more flexible storage options. Assembled.

Item #	Description	Product Dimensions	List Price
6-1439525-670	Vertical Mailbox Storage Unit	29-1/2 Wx14-3/4 Dx35-3/4 H in	\$1,153.95



**Childcraft® Extra-Wide Construction Paper Holder**

All-birch panels. Holds 9 x 12 inch and 12 x 18 inch paper. Assembled.

Item #	Description	Product Dimensions	List Price
5-071988-670	Construction Paper Holder	29-3/8 W x 12-3/4 D x 15 H in	\$306.95





**Safco® Wood Adjustable Compartment Literature Organizers**

Keep classroom supplies and projects neat and organized. Shelves are adjustable or removable to customize the compartments to keep literature at hand for quick access. Cabinet is 5/8" compressed wood. Shelves form 9" W x 11-3/4" D x 2-1/2" H letter size compartments that are adjustable in 2-1/2" increments. Combine units with and without drawers for ultimate flexibility. 39-1/4" wide units may be stacked up to 3 high or up to 72 compartments. Black plastic molding complements finish. Labels included. Hardboard shelves have up to 15 lb. capacity. Solid fiberboard back. **Available in Gray and Medium Oak.**

Please specify color choice when ordering.

Item #	Product Dimensions	Number of Compartments	Color	List Price
<b>A</b> 5-1362615-670	19-1/2 W x 11-3/4 D x 21 H in	16	Specify	\$195.95
<b>B</b> 5-1362616-670	39-1/4 W x 11-3/4 D x 16-1/4 H	24	Specify	\$246.95
<b>C</b> 5-1362617-670	39-1/4 W x 11-3/4 D x 24 H in	36	Specify	\$298.95
<b>D</b> 5-1362620-670	39-1/4 W x 11-3/4 D x 25-1/4 H	32	Specify	\$345.95



**Safco® Wood Mail Sorters**

Sturdy strength will help you sort! Sturdy Mail Sorters are made of compressed wood with adjustable hardboard dividers. Both the 18 and 36 Compartment Sorters have large slots to accommodate over-sized envelopes. Stack up to two high to increase sorting capability. Black plastic molding does double-duty, first as an attractive accent to the finish and second as a label holder for identifying the bins (labels are included). Durable laminate finish will compliment any setting. Solid fiberboard back provides stability for the unit.

Item #	Product Dimensions	Number of Compartments	Color	List Price
<b>6-389086-670</b>	33-3/4 W x 12 D x 32-3/4 H in	18	Gray	\$392.95
<b>6-1478855-670</b>	33-3/4 W x 12 D x 32-3/4 H in	18	Black	\$392.95
<b>6-389085-670</b>	33-3/4 W x 12 D x 32-3/4 H in	36	Gray	\$442.95
<b>6-1478856-670</b>	33-3/4 W x 12 D x 32-3/4 H in	36	Black	\$442.95

SAFCO®



**Safco® Wood/Corrugated Literature Organizers**

This economical literature organizer features 5/8" compressed wood cabinetry with laminate finish and a solid fiberboard back. Durable corrugated fiberboard insets form letter-size compartments. Black plastic molding doubles as a convenient labeling area (labels included). Available in Medium Oak.

Item #	Product Dimensions	Number of Compartments	Color	List Price
<b>5-675056-670</b>	29 W x 12 D x 12 H in	12	Medium Oak	\$161.95
<b>5-675060-670</b>	29 W x 12 D x 23-1/2 H in	24	Medium Oak	\$191.95
<b>5-674816-670</b>	29 W x 12 D x 34-1/2 H in	36	Medium Oak	\$247.95



**Safco® Value Colors**

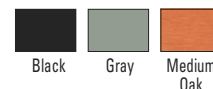

**Safco® Value Sorter® Literature Organizers**

Organize literature and keep it accessible for easy retrieval with Value Sorter Literature Organizers. Radius corners and pleasing lines impart a finished appearance suitable for all types of work environments, as well as mail rooms and communication centers. Each compartment holds letter size file folders. All steel shell and shelf supports ensure stability and durability. Compartments are made from heavy-duty corrugated fiberboard and measure 9 3/4"W x 12 1/2"D x 2 1/2"H. Please specify color when ordering. Quick-lock design for easy assembly.

Item #	Product Dimensions	Number of Compartments	Color	List Price
<b>5-1363889-670</b>	32-1/4 W x 13-1/2 D x 25-3/4 H in	24	Specify	\$371.95
<b>5-1363890-670</b>	32-1/4 W x 13-1/2 D x 38 H in	36	Specify	\$430.95
<b>5-1363891-670</b>	32-1/4 W x 13-1/2 D x 75 H in	72	Specify	\$704.95



# storage & shelving

All ship fully assembled and include casters

**CLASSROOM  
SELECT** 



PRODUCT CERTIFIED FOR LOW CHEMICAL EMISSIONS: UL.COM/IGG UL 2818



Large 5-Drawer Cabinet



Large Storage w/ Doors



Large 10-Shelf Storage w/ Doors



Medium Storage w/ Doors

## Classroom Select® Mobile Storage

Classroom Select® mobile birch storage units ship fully assembled with heavy-duty casters for mobility. Installation is a breeze with this storage line! Accommodate everything from supplies to personal items, all units have shelves that can be adjusted. Both mobile teacher storage units contain a coat compartment with door mirror and adjustable shelves. The mobile wardrobe includes a top shelf for storage with a coat rod the length of the cabinet. The 1-drawer adjustable-shelf storage unit includes one adjustable shelf in the cabinet.

Item #	Description	Product Dimensions	Number of Adjustable Shelves	Number of Fixed Shelves	List Price
6-1587693-670	Medium Teacher Storage	29-1/2 W x 24 D x 66-3/4 H in	5	1	\$1,357.95
6-1467855-670	Large Teacher Storage	48 W x 24 D x 66-3/4 H in	5	1	\$1,755.95
6-1467856-670	Large Wardrobe Storage	48 W x 24 D x 66-3/4 H in	1	-	\$1,399.95
6-1587701-670	Small Double-Sided Bookcase	29-1/2 W x 24 D x 36 H in	2	2	\$519.95
6-1587695-670	Small Storage w/Doors	29-1/2 W x 24 D x 36 H in	1	1	\$707.95
6-1467859-670	Large 1-Drawer Cabinet	48 W x 24 D x 36 H in	1	1	\$1,303.95
6-1467858-670	Small Double-Sided Bookcase	48 W x 24 D x 36 H in	2	2	\$648.95
6-1587697-670	Medium Double-Sided Bookcase	29-1/2 W x 24 D x 66-3/4 H in	8	2	\$846.95
6-1467857-670	Large Double-Sided Bookcase	48 W x 24 D x 66-3/4 H in	8	2	\$1,681.95
6-1467860-670	Large 5-Drawer Cabinet	48 W x 24 D x 36 H in	-	-	\$1,655.95
6-1587692-670	Medium Storage w/Doors	29-1/2 W x 24 D x 66-3/4 H in	5	1	\$1,403.95
6-1467853-670	Large Storage w/Doors	48 W x 24 D x 66-3/4 H in	5	1	\$1,959.95
6-1467854-670	Large 10-Shelf Storage w/Doors	48 W x 24 D x 66-3/4 H in	10	2	\$1,730.95





Medium Teacher Storage



Large Teacher Storage



Large Wardrobe Storage



Small Double-Sided Bookcase



Small Storage w/ Doors



Medium Double-Sided Bookcase



Large Double-Sided Bookcase



Large 1-Drawer Cabinet



Small Double-Sided Bookcase





**Mobile Single Sided Book Shelf Storage**



Single Sided 30" Wide  
2 Shelves

Single Sided 30" Wide  
3 Shelves

Single Sided 30" Wide  
4 Shelves

Single Sided 36" Wide  
2 Shelves

Single Sided 36" Wide  
3 Shelves

Single Sided 36" Wide  
4 Shelves

**Classroom Select® Expanse Series™ Mobile Storage**

Combine fun with function! Classroom Select® Expanse Series™ color Mobile Shelf Storage Cabinets, Mobile Locker Cubbies and Mobile Tote Storage Cabinets are designed to move easy and store easy! Cabinets are constructed of 3/4" particle board with double sided thermal fused laminate and matching 3mm PVC edge banding. Shelf storage is offered in single-sided and double-sided construction. Shelves are adjustable in one-inch increments. The Tote Cabinets are standard with 3" tote trays. The trays are interchangeable with our Concord and Advocate Series® desks and Geode Series® storage. Locking swivel casters allow for mobility and secure lock in place. Choose from an array of exciting solid colors and wood grain patterns. Fully assembled.

Item #	Description	Product Dimensions	Color	List Price
<b>Mobile Single Sided</b>				
6-5004558-670	2 Shelves	30 W x 24 D x 30 H in	Specify	\$751.95
6-5004776-670	2 Shelves	30 W x 24 D x 36 H in	Specify	\$787.95
6-5004559-670	3 Shelves	30 W x 24 D x 44 H in	Specify	\$902.95
6-5004560-670	3 Shelves	30 W x 24 D x 48 H in	Specify	\$936.95
6-5004561-670	4 Shelves	30 W x 24 D x 60 H in	Specify	\$1,115.95
6-5004777-670	2 Shelves	36 W x 24 D x 30 H in	Specify	\$816.95
6-5004778-670	2 Shelves	36 W x 24 D x 36 H in	Specify	\$854.95
6-5004779-670	3 Shelves	36 W x 24 D x 44 H in	Specify	\$984.95
6-5004780-670	3 Shelves	36 W x 24 D x 48 H in	Specify	\$1,022.95
6-5004781-670	4 Shelves	36 W x 24 D x 60 H in	Specify	\$1,401.95

**Mobile Double Sided Book Shelf Storage**



Double Sided 30" Wide  
4 Shelves

Double Sided 30" Wide  
6 Shelves

Double Sided 30" Wide  
8 Shelves

Double Sided 36" Wide  
4 Shelves

Double Sided 36" Wide  
6 Shelves

Double Sided 36" Wide  
8 Shelves

Item #	Description	Product Dimensions	Color	List Price
<b>Mobile Double Sided</b>				
6-5004540-670	4 Shelves	30 W x 24 D x 30 H in	Specify	\$799.95
6-5004770-670	4 Shelves	30 W x 24 D x 36 H in	Specify	\$836.95
6-5004554-670	6 Shelves	30 W x 24 D x 44 H in	Specify	\$984.95
6-5004555-670	6 Shelves	30 W x 24 D x 48 H in	Specify	\$1,021.95
6-5004556-670	8 Shelves	30 W x 24 D x 60 H in	Specify	\$1,238.95
6-5004771-670	4 Shelves	36 W x 24 D x 30 H in	Specify	\$867.95
6-5004772-670	4 Shelves	36 W x 24 D x 36 H in	Specify	\$906.95
6-5004773-670	6 Shelves	36 W x 24 D x 44 H in	Specify	\$1,072.95
6-5004774-670	6 Shelves	36 W x 24 D x 48 H in	Specify	\$1,111.95
6-5004775-670	8 Shelves	36 W x 24 D x 60 H in	Specify	\$1,352.95

**Classroom Select® Expanse Series® Mobile Storage Colors**

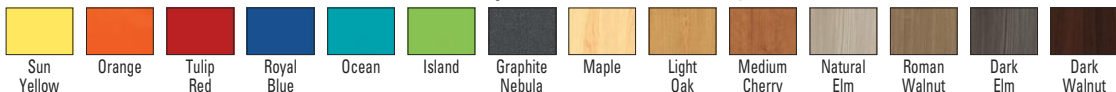



see color selection on page 248

# Classroom Select® Expanse Series™ Mobile Storage

## Mobile Locker Cubby Storage



2 Locker Cubby



3 Locker Cubby with 3 Top Shelves



4 Locker Cubby with 4 Bottom Shelves



3 Locker Cubby with 3 Top/3 Bottom Shelves

Item #	Description	Product Dimensions	Color	List Price
<b>Mobile Locker Cubbies</b>				
6-5004543-670	2 Locker	24 W x 20 D x 48 H in	Specify	\$842.95
6-5004544-670	3 Locker	36 W x 20 D x 48 H in	Specify	\$878.95
6-5004545-670	4 Locker	48 W x 20 D x 48 H in	Specify	\$956.95
6-5004546-670	2 Locker, 2 Top Shelves	24 W x 20 D x 48 H in	Specify	\$959.95
6-5004547-670	3 Locker, 3 Top Shelves	36 W x 20 D x 48 H in	Specify	\$1,033.95
6-5004548-670	4 Locker, 4 Top Shelves	48 W x 20 D x 48 H in	Specify	\$1,188.95

Item #	Description	Product Dimensions	Color	List Price
6-5004549-670	2 Locker, 2 Bottom Shelves	24 W x 20 D x 48 H in	Specify	\$959.95
6-5004550-670	3 Locker, 3 Bottom Shelves	36 W x 20 D x 48 H in	Specify	\$1,033.95
6-5004551-670	4 Locker, 4 Bottom Shelves	48 W x 20 D x 48 H in	Specify	\$1,188.95
6-5004552-670	2Locker 2 Top/2 Bottom Shelves	24 W x 20 D x 48 H in	Specify	\$931.95
6-5004553-670	3Locker 3 Top/3 Bottom Shelves	36 W x 20 D x 48 H in	Specify	\$1,087.95
6-5004575-670	4Locker 4 Top/4 Bottom Shelves	48 W x 20 D x 48 H in	Specify	\$1,360.95

## Mobile Tote Storage



A

8 Shelves Double Sided, 24 - 3" Totes



B

Door 3 Column Shelves, 24 - 3" Totes



C

2 Column, 28 - 3" Totes



D

Door 3 Column, 3 Shelves, 12 - 3" Totes



E

Door 2 Column, 12 - 3" Totes



F

3 Column, 18 - 3" Totes



G

Door 3 Column, 33 - 3" Totes



H

Presentation Cart, Door, 6 - 3" Totes

Item #	Description	Product Dimensions	Color	List Price
<b>Mobile Tote Storage</b>				
A 6-5004563-670	08 Shelves TwoSided 24-3"Totes	39 W x 30 D x 60 H in	Specify	\$2,986.95
6-5004564-670	D8 Shelves TwoSided 24-3"Totes	39 W x 30 D x 60 H in	Specify	\$3,732.95
B 6-5004565-670	Door 3 Shelves, 24 - 3" Totes	44 W x 20 D x 44 H in	Specify	\$2,262.95
6-5004566-670	Open 3 Shelves, 24 - 3" Totes	44 W x 20 D x 44 H in	Specify	\$1,957.95
C 6-5004568-670	Open 2 Column, 28 - 3" Totes	30 W x 20 D x 60 H in	Specify	\$1,988.95
6-5004569-670	Door 2 Column, 12 - 3" Totes	30 W x 20 D x 30 H in	Specify	\$1,536.95
6-5004570-670	Open 2 Column, 12 - 3" Totes	30 W x 20 D x 30 H in	Specify	\$1,290.95
D 6-5004767-670	D3 Column 3 Shelves 12-3"Totes	44 W x 20 D x 30 H in	Specify	\$1,895.95

Item #	Description	Product Dimensions	Color	List Price
E 6-5004571-670	Open3Column3Shelves 12-3"Totes	44 W x 20 D x 30 H in	Specify	\$1,623.95
6-5004572-670	Door 3 Column, 18 - 3" Totes	44 W x 20 D x 30 H in	Specify	\$1,850.95
F 6-5004573-670	Open 3 Column, 18 - 3" Totes	44 W x 20 D x 30 H in	Specify	\$1,579.95
G 6-5004574-670	Door 3 Column, 33 - 3" Totes	44 W x 20 D x 48 H in	Specify	\$2,642.95
6-5004768-670	Open 3 Column, 33 - 3" Totes	44 W x 20 D x 48 H in	Specify	\$2,271.95
H 6-5004769-670	PresentationCart Door6-3"Totes	36 W x 24 D x 40 H in	Specify	\$2,642.95

all mobile tote storage available with or without doors



Fleetwood Designer 2.0 Laminate Colors



**Designer 2.0 Mobile Storage**

Clean, versatile, ergonomic and safe. Designer 2.0's award-winning comprehensive portfolio blends perfectly with Fleetwood's perimeter and space division storage.

**Designer 2.0 Monitor Hutch**

Features removable panel to attach monitor inside the hutch. Lower storage has an adjustable shelf.



Item #	Description	Product Dimensions	Color	List Price
6-5009888-670	Laminate Back	48 W x 20 D x 68 H in	Specify	\$5,326.95
6-5009713-670	Markerboard Back	48 W x 20 D x 68 H in	Specify	\$5,326.95

**Designer 2.0 Markerboard Floor Cushion Storage**

Features markerboard laminate on the ends for collaboration and the front and back have an adjustable shelf and each hold up to 15 cushions.



Item #	Description	Product Dimensions	Color	List Price
6-5009693-670	Markerboard Laminate	36 W x 20 D x 68 H in	Specify	\$3,225.95

**Designer 2.0 Poster Drawer**

Features 4 drawers and one deep drawer. Drawers are non-locking. Drawers accommodate posters 32" wide and 24" deep.



Item #	Description	Product Dimensions	Color	List Price
6-5009891-670	Drawer, Laminate Back	36 W x 27 D x 29 H in	Specify	\$3,076.95
6-5009683-670	Drawer, Markerboard Back	36 W x 27 D x 29 H in	Specify	\$3,562.95
6-5009895-670	Drawer, Pegboard Back	36 W x 27 D x 29 H in	Specify	\$3,562.95

**Designer 2.0 Floor Cushion Storage**

Features easy to load and remove cushion compartments. Holds 30 floor cushions, 10 per column.



Item #	Description	Product Dimensions	Color	List Price
6-5009890-670	Laminate Back	48 W x 20 D x 37 H in	Specify	\$1,880.95
6-5009637-670	Markerboard Back	48 W x 20 D x 37 H in	Specify	\$2,100.95
6-5009789-670	Pegboard Back	48 W x 20 D x 37 H in	Specify	\$2,100.95





Fleetwood Designer 2.0 Laminate Colors



**Designer 2.0 Mobile Storage**

Clean, versatile, ergonomic and safe. Designer 2.0's award-winning comprehensive portfolio blends perfectly with Fleetwood's perimeter and space division storage.



**Designer 2.0 Shelf Drawer Storage**

Features locking box & file drawers and 3 adjustable shelves behind locking doors.



For more color options, please contact your Sales Rep.

**Designer 2.0 Wardrobe Tower**

Features drawer storage, box/box/file, along with coat storage and personal storage.

Item #	Description	Product Dimensions	Color	List Price
6-5009889-670	Laminate Back	30 W x 20 D x 68 H in	Specify	\$3,241.95
6-5009758-670	Markerboard Back	30 W x 20 D x 68 H in	Specify	\$3,890.95
6-5009892-670	Pegboard Back	30 W x 20 D x 68 H in	Specify	\$3,890.95

Item #	Description	Product Dimensions	Color	List Price
6-5009893-670	Laminate Back	24 W x 20 D x 68 H in	Specify	\$3,535.95
6-5009844-670	Magnetic Markerboard Back	24 W x 20 D x 68 H in	Specify	\$4,088.95
6-5009846-670	Magnetic Pegboard Back	24 W x 20 D x 68 H in	Specify	\$4,088.95



**Designer 2.0 Tray Shelf Storage**

Features open access to an adjustable shelf and 30 Gratnells trays.

Item #	Description	Product Dimensions	Color	List Price
6-5009894-670	Laminate Back	42 W x 20 D x 68 H in	Specify	\$4,503.95
6-5009896-670	Markerboard Back	42 W x 20 D x 68 H in	Specify	\$5,151.95
6-5009897-670	Pegboard Back	42 W x 20 D x 68 H in	Specify	\$5,151.95



**Designer 2.0 Markerboard Tray Storage**

Features markerboard laminate on the ends for collaboration. The front and back sides each have an adjustable shelf and holds 10 Gratnells trays. Pass-thru compartment for large item storage.

Item #	Description	Product Dimensions	Color	List Price
6-5009635-670	Markerboard Tray Storage	36 W x 20 D x 68 H in	Specify	\$4,230.95



**Fleetwood Designer 2.0 Laminate Colors**



For more color options, contact your Sales Rep.

**Designer 2.0 Mobile Storage**

Clean, versatile, ergonomic and safe. Designer 2.0's award-winning comprehensive portfolio blends perfectly with Fleetwood's perimeter and space division storage.



**Designer 2.0 Presentation Cart**

Features oversized worksurface. Power with 72" cord, 6 Gratnells trays and an adjustable shelf.

Item #	Description	Product Dimensions	Color	List Price
6-5009791-670	Presentation Cart	36 W x 22 D x 40 H in	Specify	\$3,053.95



**Designer 2.0 3D Printer Cart**

Features apparatus rods to hold coils of material and an adjustable shelf.

Item #	Description	Product Dimensions	Color	List Price
6-5009884-670	Laminate Back	36 W x 20 D x 37 H in	Specify	\$2,588.95
6-5009815-670	Markerboard Back	36 W x 20 D x 37 H in	Specify	\$3,050.95
6-5009663-670	Pegboard Back	36 W x 20 D x 37 H in	Specify	\$3,050.95



**Designer 2.0 Project Cart**

Features ample work area for projects. Holds 12 Gratnells trays, adjustable shelves, power cord management, Burele power unit with 4 plugs and easy to maneuver side handles.

Item #	Description	Product Dimensions	Color	List Price
6-5009883-670	Laminate Back	42 W x 20 D x 37 H in	Specify	\$3,966.95
6-5009699-670	Markerboard Back	42 W x 20 D x 37 H in	Specify	\$4,486.95
6-5009752-670	Pegboard Back	42 W x 20 D x 37 H in	Specify	\$4,486.95



**Designer 2.0 Shelf Cabinet with Mounting Board**

Features open access to adjustable shelves. Mounting board provides a surface to mount tool storage and the back has markerboard laminate. Mounting board is sold separately.

Item #	Description	Product Dimensions	Color	List Price
6-5009887-670	No Doors-Laminate Back	48 W x 20 D x 37 H in	Specify	\$1,382.95
6-5009838-670	Markerboard Back	48 W x 20 D x 37 H in	Specify	\$1,841.95
6-5009886-670	Pegboard Back	48 W x 20 D x 37 H in	Specify	\$1,841.95
6-2105886-670	Mounting Board	48 W x 24 H in	Silver	\$393.95

**CLASSROOM  
SELECT** 



Single Wide Open  
with 5-3" Totes - Short



Single Wide Open  
with 2 Shelves - Medium



Single Wide  
with Door and 6-6" Totes - Tall

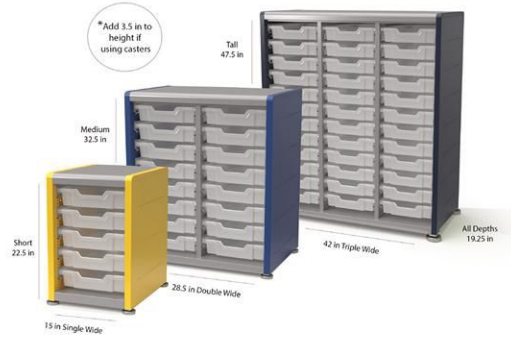

**Classroom Select® Geode Series® Storage - Single Wide - 15"**

An engaging learning environment needs compelling teaching materials. Store your classroom needs in confidence with the Classroom Select® Geode Series®. Built like a rock with a durable 18-gauge steel frame and side panels available in 11 vibrant color options to make any room shine. Super heavy duty 4-inch zinc alloy locking casters provide smooth and reliable transportation. Select locking doors for added protection, because with the Classroom Select® Geode Series®, it's about what's on the inside. All units are shipped fully assembled. Choose from short, medium and tall height in single wide versions. Accessories compatible with short and medium sizes only. Push handles are available in single solid color only. Additional features include:

- Sliding tote trays, available in options of 3", 6", or 12" tall totes that are compatible with Classroom Select® desks Concord and Advocate Series®.
- Side panels feature rows of peg board perforations for increased storage potential.
- Durable steel shelving adjustable in 1" increments to fit your storage space needs. Combine shelves and totes on select units for a more adaptable solution.

**Standard Back**

**Markerboard Back**

Description	Number of Totes	Side Panel Color	With Glides		With Casters		With Glides		With Casters	
			Item #	List Price	Item #	List Price	Item #	List Price	Item #	List Price
<b>Short</b>										
Open w/ 1 shelf	—	Specify	6-5003300-670	\$752.95	6-5003461-670	\$860.95	6-5003310-670	\$828.95	6-5003527-670	\$936.95
Door w/ 1 shelf	—	Specify	6-5003366-670	\$866.95	6-5003474-670	\$974.95	6-5003374-670	\$943.95	6-5003469-670	\$1,051.95
Open w/ 5-3" totes	5	Specify	6-5003315-670	\$839.95	6-5003555-670	\$946.95	6-5003301-670	\$915.95	6-5003451-670	\$1,023.95
Door w/ 5-3" totes	5	Specify	6-5003313-670	\$953.95	6-5003452-670	\$1,061.95	6-5003314-670	\$1,030.95	6-5003453-670	\$1,137.95
Open w/ 3-3" totes and 1-6" tote	4	Specify	6-5003382-670	\$817.95	6-5003540-670	\$924.95	6-5003383-670	\$893.95	6-5003468-670	\$1,001.95
Door w/ 3-3 totes and 1-6" tote	4	Specify	6-5003332-670	\$931.95	6-5003547-670	\$1,039.95	6-5003321-670	\$1,008.95	6-5003526-670	\$1,115.95
<b>Medium</b>										
Open w/ 2 shelves	—	Specify	6-5003385-670	\$935.95	6-5003557-670	\$1,043.95	6-5003384-670	\$1,029.95	6-5003581-670	\$1,137.95
Door w/ 2 shelves	—	Specify	6-5003377-670	\$1,085.95	6-5003549-670	\$1,193.95	6-5003335-670	\$1,179.95	6-5003464-670	\$1,287.95
Open w/ 8-3" totes	8	Specify	6-5003397-670	\$1,048.95	6-5003533-670	\$1,156.95	6-5003351-670	\$1,142.95	6-5003462-670	\$1,250.95
Door w/ 8-3" totes	8	Specify	6-5003396-670	\$1,197.95	6-5003467-670	\$1,305.95	6-5003537-670	\$1,292.95	6-5003477-670	\$1,400.95
Open w/ 4-3" totes and 2-6" totes	6	Specify	6-5003344-670	\$1,009.95	6-5003456-670	\$1,116.95	6-5003353-670	\$1,103.95	6-5003479-670	\$1,210.95
Door w/ 4-3" totes and 2-6" totes	6	Specify	6-5003316-670	\$1,158.95	6-5003560-670	\$1,266.95	6-5003410-670	\$1,253.95	6-5003563-670	\$1,360.95
Open w/ 4-6" totes	4	Specify	6-5003388-670	\$974.95	6-5003553-670	\$1,081.95	6-5003414-670	\$1,068.95	6-5003465-670	\$1,175.95
Door w/ 4-6" totes	4	Specify	6-5003309-670	\$1,123.95	6-5003542-670	\$1,231.95	6-5003361-670	\$1,217.95	6-5003494-670	\$1,325.95
<b>Tall</b>										
Open w/ 3 shelves	—	Specify	6-5003371-670	\$1,167.95	6-5003584-670	\$1,274.95	6-5003337-670	\$1,275.95	6-5003511-670	\$1,383.95
Door w/ 3 shelves	—	Specify	6-5003389-670	\$1,366.95	6-5003593-670	\$1,473.95	6-5003329-670	\$1,474.95	6-5003577-670	\$1,582.95
Open w/ 12-3" totes	12	Specify	6-5003422-670	\$1,330.95	6-5003578-670	\$1,438.95	6-5003408-670	\$1,438.95	6-5003496-670	\$1,546.95
Door w/ 12-3" totes	12	Specify	6-5003404-670	\$1,529.95	6-5003506-670	\$1,637.95	6-5003407-670	\$1,637.95	6-5003602-670	\$1,745.95
Open w/ 3-3" totes and 5-6" totes	8	Specify	6-5003443-670	\$1,266.95	6-5003541-670	\$1,374.95	6-5003386-670	\$1,374.95	6-5003562-670	\$1,482.95
Door w/ 3-3" totes and 5-6" totes	8	Specify	6-5003370-670	\$1,465.95	6-5003488-670	\$1,572.95	6-5003356-670	\$1,573.95	6-5003513-670	\$1,681.95
Open w/ 6-6" totes	6	Specify	6-5003426-670	\$1,222.95	6-5003484-670	\$1,330.95	6-5003327-670	\$1,330.95	6-5003588-670	\$1,438.95
Door w/ 6-6" totes	6	Specify	6-5003411-670	\$1,421.95	6-5003498-670	\$1,528.95	6-5003423-670	\$1,529.95	6-5003590-670	\$1,637.95

**Classroom Select® Geode Series® Side Panel Colors**

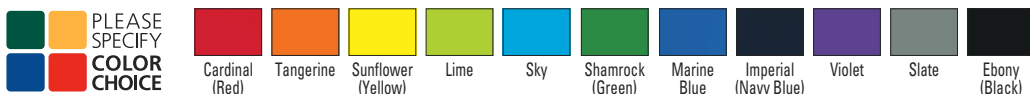



PLEASE SPECIFY COLOR CHOICE  
Refer to pages 253 for color options.



CLASSROOM SELECT

Accessories found on page 256



Double Wide Open with 1 Shelf and Markerboard Back - Short



Double Wide Open with 16 3" Totes - Medium

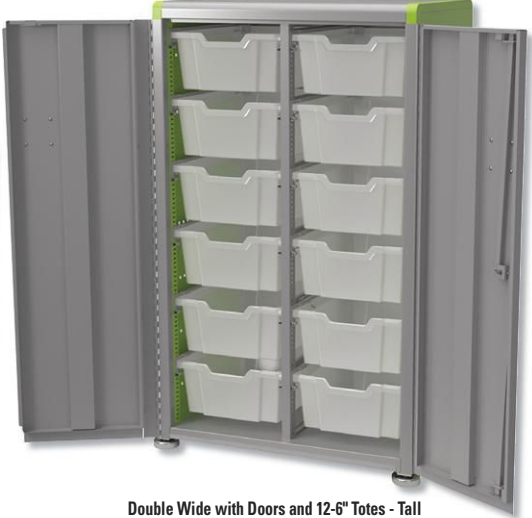

Double Wide with Doors and 12-6" Totes - Tall

Classroom Select® Geode Series Storage™ - Double Wide - 36"

Description	Number of Totes	Side Panel Color	Standard Back				Markerboard Back			
			With Glides		With Casters		With Glides		With Casters	
			Item #	List Price	Item #	List Price	Item #	List Price	Item #	List Price
<b>Short</b>										
Open w/ 1 shelf	–	Specify	6-5003343-670	\$955.95	6-5003531-670	\$1,062.95	6-5003319-670	\$1,064.95	6-5003475-670	\$1,172.95
Door w/ 1 shelf	–	Specify	6-5003421-670	\$1,181.95	6-5003455-670	\$1,288.95	6-5003318-670	\$1,290.95	6-5003495-670	\$1,398.95
Open w/ 10-3" totes	10	Specify	6-5003307-670	\$1,197.95	6-5003528-670	\$1,305.95	6-5003305-670	\$1,307.95	6-5003459-670	\$1,415.95
Door w/ 10-3" totes	10	Specify	6-5003322-670	\$1,424.95	6-5003490-670	\$1,531.95	6-5003304-670	\$1,533.95	6-5003548-670	\$1,641.95
Open w/ 6-3" totes and 2-6" totes	8	Specify	6-5003328-670	\$1,153.95	6-5003550-670	\$1,261.95	6-5003312-670	\$1,263.95	6-5003485-670	\$1,371.95
Door w/ 6-3" totes and 2-6" totes	8	Specify	6-5003302-670	\$1,379.95	6-5003491-670	\$1,487.95	6-5003306-670	\$1,489.95	6-5003499-670	\$1,597.95
<b>Medium</b>										
Open w/ 2 shelves	–	Specify	6-5003432-670	\$1,195.95	6-5003558-670	\$1,303.95	6-5003339-670	\$1,342.95	6-5003551-670	\$1,450.95
Door w/ 2 shelves	–	Specify	6-5003413-670	\$1,494.95	6-5003597-670	\$1,602.95	6-5003355-670	\$1,641.95	6-5003482-670	\$1,749.95
Open w/ 16-3" totes	16	Specify	6-5003433-670	\$1,525.95	6-5003535-670	\$1,633.95	6-5003390-670	\$1,672.95	6-5003538-670	\$1,780.95
Door w/ 16-3" totes	16	Specify	6-5003367-670	\$1,823.95	6-5003514-670	\$1,931.95	6-5003424-670	\$1,971.95	6-5003478-670	\$2,078.95
Open w/ 8-3" totes and 4-6" totes	12	Specify	6-5003392-670	\$1,447.95	6-5003568-670	\$1,554.95	6-5003434-670	\$1,594.95	6-5003543-670	\$1,702.95
Door w/ 8-3" totes and 4-6" totes	12	Specify	6-5003416-670	\$1,746.95	6-5003509-670	\$1,853.95	6-5003340-670	\$1,892.95	6-5003483-670	\$2,000.95
Open w/ 8-6" totes	8	Specify	6-5003427-670	\$1,376.95	6-5003545-670	\$1,484.95	6-5003354-670	\$1,523.95	6-5003500-670	\$1,631.95
Door w/ 8-6" totes	8	Specify	6-5003303-670	\$1,675.95	6-5003463-670	\$1,783.95	6-5003395-670	\$1,822.95	6-5003554-670	\$1,930.95
<b>Tall</b>										
Open w/ 3 shelves	–	Specify	6-5003450-670	\$1,509.95	6-5003571-670	\$1,616.95	6-5003440-670	\$1,657.95	6-5003525-670	\$1,765.95
Door w/ 3 shelves	–	Specify	6-5003375-670	\$1,905.95	6-5003516-670	\$2,013.95	6-5003372-670	\$2,054.95	6-5003487-670	\$2,162.95
Open w/ 24-3" totes	24	Specify	6-5003412-670	\$1,983.95	6-5003579-670	\$2,091.95	6-5003359-670	\$2,131.95	6-5003567-670	\$2,239.95
Door w/ 24-3" totes	24	Specify	6-5003345-670	\$2,380.95	6-5003480-670	\$2,487.95	6-5003437-670	\$2,528.95	6-5003524-670	\$2,636.95
Open w/ 6-3" totes and 2-12" totes	14	Specify	6-5003402-670	\$1,819.95	6-5003573-670	\$1,927.95	6-5003400-670	\$1,967.95	6-5003517-670	\$2,075.95
Door w/ 6-3" totes and 2-12" totes	14	Specify	6-5003360-670	\$2,216.95	6-5003532-670	\$2,324.95	6-5003431-670	\$2,364.95	6-5003521-670	\$2,472.95
Open w/ 12-6" totes	12	Specify	6-5003438-670	\$1,766.95	6-5003476-670	\$1,874.95	6-5003362-670	\$1,915.95	6-5003582-670	\$2,022.95
Door w/ 12-6" totes	12	Specify	6-5003347-670	\$2,163.95	6-5003515-670	\$2,271.95	6-5003420-670	\$2,311.95	6-5003508-670	\$2,419.95

**CLASSROOM  
SELECT** 



**PLEASE  
SPECIFY  
COLOR  
CHOICE**  
Refer to page 253  
for color options.



Triple Wide with 1 Shelf - Short



Triple Wide Open with 24-3" Totes - Medium

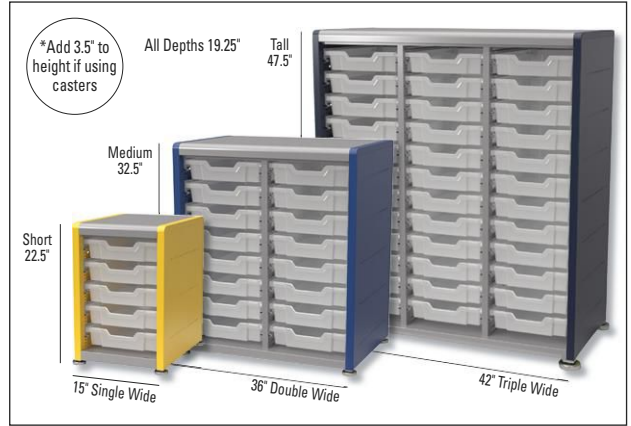

Triple Wide with Doors and 9-3", 9-6" and 3-12" Totes - Tall

**Classroom Select® Geode Series Storage™ - Triple Wide - 42"**

**Standard Back**

**Markerboard Back**

Description	Number of Totes	Side Panel Color	With Glides		With Casters		With Glides		With Casters	
			Item #	List Price	Item #	List Price	Item #	List Price	Item #	List Price
<b>Short</b>										
Open w/ 1 shelf	—	Specify	6-5003369-670	\$1,151.95	6-5003544-670	\$1,258.95	6-5003330-670	\$1,285.95	6-5003457-670	\$1,393.95
Door w/ 1 shelf	—	Specify	6-5003334-670	\$1,418.95	6-5003458-670	\$1,526.95	6-5003308-670	\$1,553.95	6-5003472-670	\$1,660.95
Open w/ 15-3" totes	15	Specify	6-5003325-670	\$1,554.95	6-5003529-670	\$1,662.95	6-5003331-670	\$1,688.95	6-5003493-670	\$1,796.95
Door w/ 15-3" totes	15	Specify	6-5003338-670	\$1,822.95	6-5003492-670	\$1,930.95	6-5003311-670	\$1,956.95	6-5003470-670	\$2,064.95
Open w/ 9-3" totes and 3-6" totes	12	Specify	6-5003381-670	\$1,488.95	6-5003564-670	\$1,596.95	6-5003373-670	\$1,622.95	6-5003596-670	\$1,730.95
Door w/ 9-3" totes and 3-6" totes	12	Specify	6-5003320-670	\$1,756.95	6-5003466-670	\$1,864.95	6-5003326-670	\$1,890.95	6-5003481-670	\$1,998.95
<b>Medium</b>										
Open w/ 2 shelves	—	Specify	6-5003346-670	\$1,446.95	6-5003504-670	\$1,553.95	6-5003333-670	\$1,599.95	6-5003576-670	\$1,706.95
Door w/ 2 shelves	—	Specify	6-5003317-670	\$1,807.95	6-5003561-670	\$1,915.95	6-5003358-670	\$1,960.95	6-5003569-670	\$2,068.95
Open w/ 24-3" totes	24	Specify	6-5003323-670	\$2,002.95	6-5003520-670	\$2,110.95	6-5003352-670	\$2,155.95	6-5003556-670	\$2,263.95
Door w/ 24-3" totes	24	Specify	6-5003324-670	\$2,363.95	6-5003460-670	\$2,471.95	6-5003445-670	\$2,516.95	6-5003489-670	\$2,624.95
Open w/ 12-3" totes and 6-6" totes	18	Specify	6-5003391-670	\$1,885.95	6-5003454-670	\$1,992.95	6-5003349-670	\$2,037.95	6-5003565-670	\$2,145.95
Door w/ 12-3" totes and 6-6" totes	18	Specify	6-5003417-670	\$2,246.95	6-5003497-670	\$2,354.95	6-5003418-670	\$2,399.95	6-5003486-670	\$2,507.95
Open w/ 2 shelves and 8-3" totes	8	Specify	6-5003341-670	\$1,680.95	6-5003586-670	\$1,788.95	6-5003446-670	\$1,833.95	6-5003552-670	\$1,940.95
Door w/ 2 shelves and 8-3" totes	8	Specify	6-5003405-670	\$2,041.95	6-5003539-670	\$2,149.95	6-5003429-670	\$2,194.95	6-5003471-670	\$2,302.95
<b>Tall</b>										
Open w/ 3 shelves	—	Specify	6-5003363-670	\$1,809.95	6-5003507-670	\$1,916.95	6-5003336-670	\$2,004.95	6-5003546-670	\$2,112.95
Door w/ 3 shelves	—	Specify	6-5003342-670	\$2,291.95	6-5003473-670	\$2,399.95	6-5003348-670	\$2,487.95	6-5003512-670	\$2,594.95
Open w/ 36-3" totes	36	Specify	6-5003409-670	\$2,607.95	6-5003599-670	\$2,715.95	6-5003378-670	\$2,802.95	6-5003594-670	\$2,910.95
Door w/ 36-3" totes	36	Specify	6-5003398-670	\$3,089.95	6-5003591-670	\$3,197.95	6-5003401-670	\$3,285.95	6-5003592-670	\$3,392.95
Open w/ 9-3" totes and 15-6" totes	24	Specify	6-5003394-670	\$2,414.95	6-5003580-670	\$2,521.95	6-5003425-670	\$2,609.95	6-5003570-670	\$2,717.95
Door w/ 9-3" totes and 15-6" totes	24	Specify	6-5003357-670	\$2,896.95	6-5003574-670	\$3,004.95	6-5003403-670	\$3,092.95	6-5003585-670	\$3,199.95
Open w/ 9-3", 9-6" and 3-12" totes	21	Specify	6-5003444-670	\$2,361.95	6-5003501-670	\$2,469.95	6-5003399-670	\$2,556.95	6-5003595-670	\$2,664.95
Door w/ 9-3", 9-6" and 3-12" totes	21	Specify	6-5003387-670	\$2,843.95	6-5003572-670	\$2,951.95	6-5003368-670	\$3,039.95	6-5003575-670	\$3,147.95
Open w/ 24-3" totes and 6-6" totes	24	Specify	6-5003428-670	\$2,489.95	6-5003518-670	\$2,597.95	6-5003447-670	\$2,685.95	6-5003502-670	\$2,793.95
Door w/ 24-3" totes and 6-6" totes	24	Specify	6-5003435-670	\$2,972.95	6-5003505-670	\$3,080.95	6-5003415-670	\$3,167.95	6-5003530-670	\$3,275.95
Open w/ 3 shelves and 12-3" totes	12	Specify	6-5003442-670	\$2,140.95	6-5003583-670	\$2,248.95	6-5003441-670	\$2,336.95	6-5003587-670	\$2,443.95
Door w/ 3 shelves and 12-3" totes	12	Specify	6-5003379-670	\$2,623.95	6-5003601-670	\$2,730.95	6-5003439-670	\$2,818.95	6-5003566-670	\$2,926.95



**Classroom Select® Geode Series® Storage**

Create your own Geode Series® Lectern or Riser with a solid Geode Series® Storage base. First, choose your cabinet base with your choice of shelf or tote options to store your teaching materials. Select your top, the riser is a perfect option for a flat elevated surface for your storage base. The lectern is a great option for a slightly angled top for a perfect presentation tool for your classroom. A markerboard back would be a great solution to expand your presentation needs. Casters offer the flexibility of movement while glides keep your unit securely in place, you choose!!

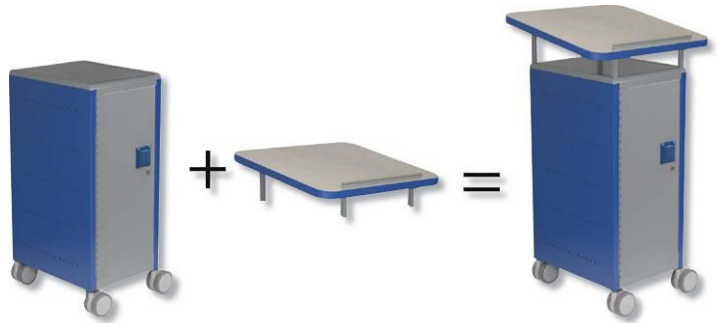

**Standard Back**

**Markerboard Back**

Description	# of Totes	Side Panel Color	With Casters		With Glides		With Casters		With Glides	
			Item #	List Price	Item #	List Price	Item #	List Price	Item #	List Price
<b>Single Wide - 15"W</b>										
Open w/ 2 shelves	-	Specify	6-5003557-670	\$1,043.95	6-5003385-670	\$935.95	6-5003581-670	\$1,137.95	6-5003384-670	\$1,029.95
Door w/ 2 shelves	-	Specify	6-5003549-670	\$1,193.95	6-5003377-670	\$1,085.95	6-5003464-670	\$1,287.95	6-5003335-670	\$1,179.95
Open 2/ 8-3" totes	8	Specify	6-5003533-670	\$1,156.95	6-5003397-670	\$1,048.95	6-5003462-670	\$1,250.95	6-5003311-670	\$1,142.95
Door w/ 8-3" totes	8	Specify	6-5003467-670	\$1,305.95	6-5003396-670	\$1,197.95	6-5003477-670	\$1,400.95	6-5003537-670	\$1,292.95
Open w/ 4-3" totes and 2-6" totes	6	Specify	6-5003456-670	\$1,116.95	6-5003344-670	\$1,009.95	6-5003479-670	\$1,210.95	6-5003353-670	\$1,103.95
Door w/ 4-3" totes and 2-6" totes	6	Specify	6-5003560-670	\$1,266.95	6-5003316-670	\$1,158.95	6-5003563-670	\$1,360.95	6-5003410-670	\$1,253.95
Open w/ 4-6" totes	4	Specify	6-5003553-670	\$1,081.95	6-5003388-670	\$974.95	6-5003465-670	\$1,175.95	6-5003414-670	\$1,068.95
Door w/ 4-6" totes	4	Specify	6-5003542-670	\$1,231.95	6-5003309-670	\$1,123.95	6-5003494-670	\$1,325.95	6-5003361-670	\$1,217.95

Accessories	Top Color	Edge Color	Item #	List Price
Riser - Single Wide	Specify	Specify	6-5003737-670	\$392.95
Lectern - Single Wide	Specify	Specify	6-5003735-670	\$547.95

See pages 253- 255 for the coordinating Geode Series® Storage line.

**Classroom Select® Geode Series® Side Panel Colors**

PLEASE SPECIFY COLOR CHOICE

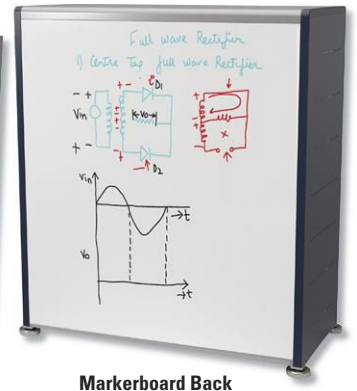
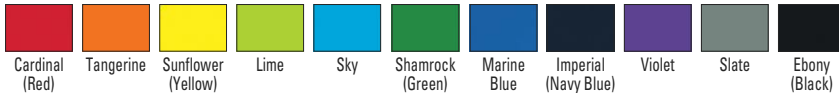

**Classroom Select® Geode Series™ Cubby Storage**

**Standard Back**

**Markerboard Back**

Description	Side Panel Color	With Casters		With Glides		With Casters		With Glides	
		Item #	List Price	Item #	List Price	Item #	List Price	Item #	List Price
<b>Triple Wide - 42" W</b>									
Short (26"H) - Open - 6 Cubbies	Specify	6-5003503-670	\$1,404.95	6-5003419-670	\$1,296.95	6-5003522-670	\$1,538.95	6-5003350-670	\$1,430.95
Short (26"H) - Door - 6 Cubbies	Specify	6-5003519-670	\$1,672.95	6-5003448-670	\$1,564.95	6-5003534-670	\$1,806.95	6-5003406-670	\$1,698.95
Med (36" H) - Open - 9 Cubbies	Specify	6-5003536-670	\$1,752.95	6-5003436-670	\$1,645.95	6-5003603-670	\$1,905.95	6-5003364-670	\$1,798.95
Med (36" H) - Door - 9 Cubbies	Specify	6-5003523-670	\$2,114.95	6-5003365-670	\$2,006.95	6-5003598-670	\$2,267.95	6-5003430-670	\$2,159.95
Tall (51"H) - Open - 12 Cubbies	Specify	6-5003559-670	\$2,190.95	6-5003393-670	\$2,083.95	6-5003589-670	\$2,386.95	6-5003376-670	\$2,278.95
Tall (51"H) - Door - 12 Cubbies	Specify	6-5003510-670	\$2,673.95	6-5003380-670	\$2,565.95	6-5003600-670	\$2,868.95	6-5003449-670	\$2,761.95





A



B



C



D



### Quantum Storage Wire Shelving Bin Units

These economical, high density bin storage systems include heavy-duty stack bins with open hopper fronts for easy access. Large variety of combinations and sizes make it easy to choose a package to fit any situation. Heavy-duty, wire shelving has capacity of 400 lbs. per shelf and is available in a Chrome finish.

• **PLEASE NOTE:** Bins in 24"D are only available in Blue, Red and Yellow.

Item #	Description	Product Dimensions	Starter/Adder	Color	Number of Shelves	List Price
A 6-1433942-670	Unit with 28 Bins	36 W x 12 D x 74 H in	Starter	Specify	8	\$1,998.95
6-1433945-670	Unit with 14 Bins	36 W x 14 D x 74 H in	Starter	Specify	8	\$1,803.95
6-1433946-670	Unit with 21 Bins	36 W x 18 D x 74 H in	Starter	Specify	8	\$2,489.95
6-1433947-670	Unit with 15 Bins	36 W x 18 D x 74 H in	Starter	Specify	6	\$2,314.95
6-1433948-670	Unit with 20 Bins	36 W x 18 D x 74 H in	Starter	Specify	6	\$2,272.95
6-1433949-670	Unit with 8 Bins	36 W x 18 D x 74 H in	Starter	Specify	5	\$1,680.95
B 6-1433950-670	Unit with 28 Bins	36 W x 24 D x 74 H in	Starter	Specify	8	\$3,433.95
C 6-1433951-670	Unit with 21 Bins	36 W x 24 D x 74 H in	Starter	Specify	8	\$3,311.95
D 6-1433953-670	Unit with 24 Bins	36 W x 24 D x 74 H in	Starter	Specify	7	\$3,280.95
6-1433954-670	Unit with 15 Bins	36 W x 24 D x 74 H in	Starter	Specify	6	\$2,520.95
6-1433955-670	Unit with 10 Bins	36 W x 24 D x 74 H in	Starter	Specify	6	\$2,393.95
6-1433957-670	Unit with 8 Bins	42 W x 24 D x 74 H in	Starter	Specify	5	\$2,106.95

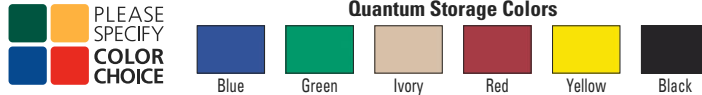

### Quantum Storage Wire Utility Carts

Wire utility cart has swivel casters, shelves, and two ergonomically positioned U-shaped handles; suitable for sorting, storing, and transporting items. Wire shelves are made of welded steel and reinforced with wire trusses for strength. Shelves adjust in 1" increments to accommodate items of varying height. Four 5" polyurethane swivel casters with brakes on two of them for control and maneuverability. Four non-marking rubber donut bumpers help protect walls and furniture from damage. Has an 800 lb. per shelf capacity, total cart capacity not to exceed 1,200 lbs. Most sizes are available in Chrome or flat Black (42 in D available in chrome only.)

Item #	Description	Product Dimensions	Color	Number of Trays	List Price
5-1494451-670	2 Shelf	18 W x 36 D x 37-1/2 H in	Specify	2	\$503.95
5-1494452-670	2 Shelf	18 W x 42 D x 37-1/2 H in	Specify	2	\$527.95
5-1494453-670	2 Shelf	18 W x 48 D x 37-1/2 H in	Specify	2	\$555.95
5-1494454-670	2 Shelf	24 W x 36 D x 37-1/2 H in	Specify	2	\$570.95
5-1494455-670	2 Shelf	24 W x 42 D x 37-1/2 H in	Specify	2	\$597.95
5-1494456-670	2 Shelf	24 W x 48 D x 37-1/2 H in	Specify	2	\$631.95
5-1494457-670	3 Shelf	18 W x 36 D x 37-1/2 H in	Specify	3	\$588.95
5-1494458-670	3 Shelf	18 W x 42 D x 37-1/2 H in	Specify	3	\$625.95
5-1494459-670	3 Shelf	18 W x 48 D x 37-1/2 H in	Specify	3	\$666.95
5-1494460-670	3 Shelf	24 W x 36 D x 37-1/2 H in	Specify	3	\$681.95
5-1494461-670	3 Shelf	24 W x 42 D x 37-1/2 H in	Specify	3	\$721.95
5-1494462-670	3 Shelf	24 W x 48 D x 37-1/2 H in	Specify	3	\$833.95





**Gratnells MakerSpace Trolley**

The Gratnells MakerSpace Trolley holds standard Gratnells trays on StopSafe runners, allowing easy and safe access to components. Side and back panels include industry standard peg holes and slots for wide range of accessories. Comes complete with three deep (F2) trays, 12 shallow (F1) trays, 12 mini bins (only available in green), roll holder, 5 single hooks and 5 double hooks. Heavy-duty lockable caster also included.



**Gratnells MakerHub Trolley**

The Gratnells MakerHub Trolley is a multi-functional resource trolley that promotes collaborative working in STEAM activities in the classroom. Magnetic whiteboards are instantly interchangeable – simply lift up and draw down to remove. All standard boards are held safely in place between steel guides on the recessed shelf. Four deep (F2) trays are included and can face either direction. Heavy-duty lockable casters also included.



Item #	Description	Product Dimensions	Tray Colors	List Price
6-5003171-670	MakerSpace Trolley	40 W x 17 D x 62 H in	Specify	\$2,618.95

Item #	Description	Product Dimensions	Tray Colors	List Price
6-5003170-670	Makerhub Trolley	17 W x 27 D x 56 H in	Specify	\$1,846.95



A B C

**Gratnells Rover Carts**

Tough and practical, the Gratnells Rover has been designed to carry trays over any terrain and help you move heavy loads around with ease. Whether you need to take beanbags and bottled water to the field on sports day or a class full of iPads to an after-school club, the Rover is ideal for transporting anything you need, even up and down stairs. Trays and a strap to secure are included.

Item #	Description	Product Dimensions	Number of Trays	Tray Colors	List Price
A 6-5003158-670	Rover Cart w/ F2 Trays	22 W x 16-4/5 D x 46 H in	3	Specify	\$1,220.95
B 6-5003161-670	Rover Cart w/ F25 Trays	22 W x 16-4/5 D x 46 H in	3	Specify	\$1,285.95
C 6-5003146-670	Rover Cart w/ F3 Trays	22 W x 16-4/5 D x 46 H in	2	Specify	\$1,321.95



A B C D E

**Gratnells Callero Plus Storage**

Callero Plus is an ergonomically designed storage solution featuring enclosed metal framing, which reduces the need for cleaning as well as offering enhanced security. The trolleys are available in two size variations, double and triple, and are all supplied fully assembled in a durable white finish. Each unit is fitted with StopSafe runners, includes feet and locking casters.

Item #	Description	Product Dimensions	Number of Trays	Tray Colors	List Price
A 6-5003156-670	Double Cart w/ 16 Trays	27-1/5 W x 17 D x 41-1/2 H in	16	Specify	\$1,675.95
6-5003175-670	Double Cart w/ 12 Trays	27-1/5 W x 17 D x 41-1/2 H in	12	Specify	\$1,607.95
6-5003153-670	Double Cart w/ 4 Trays	27-1/5 W x 17 D x 41-1/2 H in	4	Specify	\$1,429.95
B 6-5003148-670	Double Cart w/ 8 Trays	27-1/5 W x 17 D x 41-1/2 H in	8	Specify	\$1,623.95
6-5003150-670	Triple Cart w/ 6 Trays	40-1/5 W x 17 D x 41-1/2 H in	6	Specify	\$1,573.95
C 6-5003168-670	Triple Cart w/ 9 Trays	40-1/5 W x 17 D x 41-1/2 H in	9	Specify	\$1,772.95
6-5003166-670	Triple Cart w/ 12 Trays	40-1/5 W x 17 D x 41-1/2 H in	12	Specify	\$1,857.95
6-5003169-670	Triple Cart w/ 16 Trays	40-1/5 W x 17 D x 41-1/2 H in	16	Specify	\$2,038.95
D 6-5003173-670	Triple Cart w/ 24 Trays	40-1/5 W x 17 D x 41-1/2 H in	24	Specify	\$2,129.95
E 6-5003143-670	Triple Cart w/ 6 Large Trays	40-1/5 W x 17 D x 41-1/2 H in	6	Specify	\$1,685.95

**Gratnells Tray Colors**





### Gratnells Trays and Accessories

Gratnells award winning trays come in a range of shapes and sizes to fit most standard school furniture. Made from tough, recyclable polypropylene, these trays will last for many years. Tray inserts and lids are compatible with all trays shown.

Item #	Description	Product Dimensions	Number of Trays	Tray Colors	List Price
A 5-5003154-670	F1 Tray - Pack of 8	12-1/3 W x 16-4/5 D x 3 H in	8	Specify	\$204.95
B 5-5003147-670	F2 Tray - Pack of 6	12-1/3 W x 16-4/5 D x 6 H in	6	Specify	\$218.95
C 5-5003152-670	F25 Tray - Pack of 6	12-1/3 W x 17 D x 9 H in	6	Specify	\$289.95
D 5-5003149-670	F3 Tray - Pack of 6	12-1/3 W x 17 D x 11-4/5 H in	6	Specify	\$330.95
E 5-2025434-670	Clear Lid for Trays-Pack of 8	11-1/5 W x 17 D x 1-1/3 H in	-	-	\$111.95
F 5-2025431-670	Gray 3 Part Insert - Pack of 6	10-4/5 Wx 15-1/3 Dx 1-3/5 H in	6	Gray	\$131.95
G 5-2025432-670	Gray 3 Part Insert - Pack of 6	10-4/5 Wx 15-1/3 Dx 1-3/5 H in	6	Gray	\$131.95
H 5-2025436-670	Gray 4 Part Insert - Pack of 6	10-4/5 Wx 15-1/3 Dx 1-3/5 H in	6	Gray	\$131.95
I 5-2025435-670	Gray 6 Part Insert - Pack of 6	10-4/5 Wx 15-1/3 Dx 1-3/5 H in	6	Gray	\$131.95
J 5-2025433-670	Gray 6 Part Insert - Pack of 6	10-4/5 Wx 15-1/3 Dx 1-3/5 H in	6	Gray	\$131.95
K 5-2025437-670	Gray 8 Part Insert - Pack of 6	10-4/5 Wx 15-1/3 Dx 1-3/5 H in	6	Gray	\$131.95



### Gratnells Dynamis Storage

Dynamis storage is expertly engineered to maximize storage with minimum space thanks to a slim profile and configuration options. Included with each unit are casters and rubber feet for ultimate flexibility (Combo Sets include rubber feet only). All units come with silver frames and your choice of tray colors.

Item #	Description	Product Dimensions	Number of Trays	Tray Colors	List Price
A 6-5003151-670	Low Single Cart w/6 Trays	14-3/5W x 16-3/5D x 28-1/5H in	6	Specify	\$835.95
B 6-5003155-670	Low Double Cart w/9 Trays	28 W x 16-3/5 D x 28-1/5 H in	9	Specify	\$1,181.95
B 6-5003145-670	Low Triple Cart w/15 Trays	41-1/2W x 16-3/5D x 28-1/5H in	15	Specify	\$1,690.95
C 6-5003162-670	Double Cart w/16 Trays	28 W x 16-3/5 D x 33-1/2 H in	16	Specify	\$1,005.95
6-5003163-670	Double Cart w/12 Trays	28 W x 16-3/5 D x 33-1/2 H in	12	Specify	\$1,222.95
6-5003144-670	Double Cart w/8 Trays	28 W x 16-3/5 D x 33-1/2 H in	8	Specify	\$1,236.95
6-5003159-670	Triple Cart w/12 Trays	41-1/2W x 16-3/5D x 33-1/2H in	12	Specify	\$1,556.95
D 6-5003157-670	Triple Cart w/20 Trays	41-1/2W x 16-3/5D x 33-1/2H in	20	Specify	\$1,699.95
6-5003160-670	Triple Cart w/24 Trays	41-1/2W x 16-3/5D x 33-1/2H in	24	Specify	\$1,684.95
E 6-5003174-670	Combo Set w/12 Trays	41-1/2W x 16-3/5D x 67-1/5H in	12	Specify	\$2,711.95
6-5003172-670	Combo Set w/24 Trays	41-1/2W x 16-3/5D x 67-1/5H in	24	Specify	\$2,840.95
6-5003164-670	Combo Set w/36 Trays	41-1/2W x 16-3/5D x 67-1/5H in	36	Specify	\$3,441.95

#### Gratnells Tray Colors







**Sandusky Lee® Value Line Storage Cabinets**

Cabinet features cam-locking handle, welded steel construction and a powder coat finish. Handles require assembly. Meets ANSI/BIFMA shelf standards. Fixed-shelf count includes bottom shelf. The Value Line is only available in Dove Gray, Putty, and Black.

Item #	Product Dimensions	Number of Fixed Shelves	Color	List Price
6-1499016-670	30 W x 15 D x 66 H in	4	Specify	\$802.95
6-1438327-670	30 W x 18 D x 72 H in	4	Specify	\$864.95
6-1499017-670	36 W x 18 D x 72 H in	5	Specify	\$977.95



**Sandusky Lee® Value Line Colors**

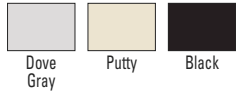

PRODUCT CERTIFIED FOR LOW CHEMICAL EMISSIONS: UL GREENGUARD UL 2818

**Sandusky Lee® Classic Series Storage Cabinets**

Heavy-gauge adjustable steel shelves that adjust on 2" centers. Tru-Glide 3-point locking assembly with satin chrome handle. Welded steel construction, powder coat finish. Handle requires some assembly. Meets ANSI/BIFMA shelf standards.

Item #	Description	Product Dimensions	Number of Fixed Shelves	Number of Adjustable Shelves	Color	List Price
6-1362501-670	Storage Cabinet	36 W x 18 D x 42 H in	1	2	Specify	\$797.95
6-1362502-670	Storage Cabinet	36 W x 24 D x 42 H in	1	2	Specify	\$1,103.95
6-1362503-670	Storage Cabinet	36 W x 18 D x 72 H in	1	4	Specify	\$1,055.95
6-1362505-670	Storage Cabinet	36 W x 18 D x 78 H in	1	4	Specify	\$1,176.95
6-1362506-670	Storage Cabinet	36 W x 24 D x 72 H in	1	4	Specify	\$1,263.95
6-1362507-670	Storage Cabinet	36 W x 24 D x 78 H in	1	4	Specify	\$1,317.95
6-1362523-670	Replacement Shelves	36 W x 18 D in	-	2 pack	Specify	\$88.95
6-1362524-670	Replacement Shelves	36 W x 24 D in	-	2 pack	Specify	\$106.95

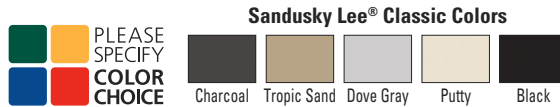

**Sandusky Steel Cubby Storage**

Heavy duty, welded all steel cubby cabinet available with 9 or 12 storage sections. Ideal for visual organization. Each opening is 14 1/2" W x 17 1/2" D x 15" H and has a 75 lb. load capacity. Powder coat finish.

Item #	Description	Product Dimensions	Number of Fixed Shelves	Color	List Price
6-1455763-670	Cubby Storage Organizer - 9	46 W x 18 D x 52 H in	3	Specify	\$587.95
6-1455764-670	Cubby Storage Organizer - 12	46 W x 18 D x 66 H in	4	Specify	\$993.95

**Sandusky Steel Cubby Colors**





PRODUCT CERTIFIED FOR LOW CHEMICAL EMISSIONS: UL.COM/IGG UL 2818



### Sandusky Lee® Elite Heavy-Duty Storage Cabinets

These sturdy cabinets feature heavy-duty welded steel construction made of 20-gauge steel sides and 22-gauge steel body. Strong 20-gauge shelves easily adjust on 2" centers and have 200 lbs. weight capacity per shelf (250 lbs. capacity on 46" wide). Recessed 3-point locking handle. 30"H cabinets include cam locking handle. Ships assembled except lock rods. Fixed shelf count includes bottom shelf.



Item #	Product Dimensions	Number of Fixed Shelves	Number of Adjustable Shelves	Color	List Price
6-1363929-670	36 W x 18 D x 42 H in	1	2	Specify	\$1,072.95
6-1363930-670	46 W x 24 D x 42 H in	1	2	Specify	\$1,525.95
6-1363932-670	36 W x 18 D x 72 H in	1	4	Specify	\$1,226.95
6-1363934-670	36 W x 24 D x 72 H in	1	4	Specify	\$1,404.95
6-1438316-670	46 W x 24 D x 72 H in	1	4	Specify	\$1,700.95
6-1363936-670	46 W x 24 D x 78 H in	1	4	Specify	\$1,768.95



### Sandusky Lee® Elite Transport Storage Cabinets

These durable all welded steel cabinets feature a patented reinforced heavy duty caster base with 5" casters (2 locking) that allow near effortless mobility. Casters are located to permit flush positioning. Height includes 6" for casters. Meets ANSI/BIFMA shelf standards. Fully assembled except for placing cabinet in caster base.

Item #	Description	Product Dimensions	Number of Fixed Shelves	Number of Adjustable Shelves	Color	List Price
6-1438323-670	Transport Mobile Storage	36 W x 24 D x 78 H in	1	4	Specify	\$1792.95
6-1363966-670	Extra Wide Mobile Storage	46 W x 24 D x 78 H in	1	4	Specify	\$2241.95

### Sandusky Lee® Combination Storage-Wardrobe Cabinet

Cabinet contains a full width top shelf, half width hanging bar, three adjustable side shelves, and a 3-point locking handle.

Item #	Product Dimensions	Number of Adjustable Shelves	Color	List Price
6-1363921-670	36 W x 18 D x 72 H in	2	Specify	\$1,201.95
6-1363923-670	36 W x 24 D x 72 H in	2	Specify	\$1,373.95



#### Sandusky Lee® Storage Colors

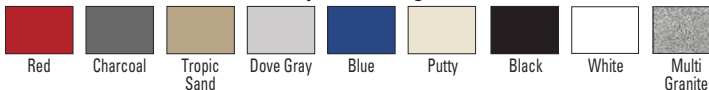



**Sandusky Lee® SnapIt™ Storage Cabinet**

Easy snap-together design assembles in minutes. Three point locking system for security. Shelves adjust on 2" increments. Chrome locking handles with two keys. Meets or exceeds all ANSI/BIFMA standards. Powder coat finish available in Dove Gray, Putty, or Black only.

Item #	Product Dimensions	Number of Adjustable Shelves	Color	List Price
6-5009623-670	36 W x 18 D x 42 H in	2	Specify	\$646.95
6-5009624-670	36 W x 18 D x 72 H in	4	Specify	\$888.95
6-1285881-670	36 W x 18 D x 72 H in	4	Specify	\$1,012.95



**Sandusky Lee® Storage Colors**

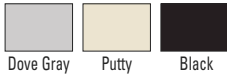

**Sandusky Lee® Wall Cabinets**

Solid Door Wall cabinet or durable acrylic doors with a window for full visibility of contents. Fully adjustable shelf on 2" centers plus raised bottom shelf. Three point locking system. Single door has a cam lock to the side. Meets ANSI/BIFMA shelf standards. Ships assembled with the exception of the handle which requires slight assembly. The Keyless Electronic wall cabinet is only available in black, dove gray, and putty and comes ready to assemble.

Item #	Description	Product Dimensions	Number of Fixed Shelves	Number of Adjustable Shelves	Color	List Price
6-1438287-670	Solid Door Wall Cabinet	18 W x 12 D x 26 H in	1	1	Specify	\$626.95
6-1438288-670	Solid Door Wall Cabinet	30 W x 12 D x 30 H in	1	1	Specify	\$668.95
6-1438289-670	Solid Door Wall Cabinet	36 W x 12 D x 30 H in	1	1	Specify	\$862.95



PRODUCT CERTIFIED FOR LOW CHEMICAL EMISSIONS: ULC Q953 UL 2818



**KC Bin Mobile Storage Cabinets**

Rugged construction for any office or classroom use. Ships fully assembled. Shelves are adjustable on 2" centers. Furnished with 2 rigid casters and 2 swivel casters with brakes.

Item #	Description	Product Dimensions	Number of Adjustable Shelves	Color	List Price
6-1386620-670	Storage Cabinet	36 W x 18 D x 48 H in	2	Specify	\$1,410.95
6-1386621-670	Storage Cabinet w/ Lat File	36 W x 18 D x 48 H in	2	Specify	\$1,762.95
6-1386622-670	Storage Cabinet	36 W x 24 D x 48 H in	2	Specify	\$1,462.95
6-1386623-670	Storage Cabinet w/ Lat File	36 W x 24 D x 48 H in	2	Specify	\$1,913.95
6-1386624-670	Storage Cabinet	36 W x 24 D x 66 H in	3	Specify	\$1,830.95
6-1386625-670	Storage Cabinet w/ Lat File	36 W x 24 D x 66 H in	3	Specify	\$2,256.95

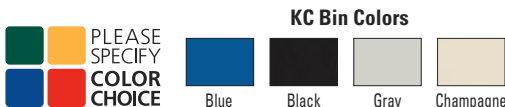





### KC Bin Standard Storage Cabinets

The standard cabinets ship fully assembled and each shelf has a 200 lb. capacity. Triple flanged shelves are adjustable on 2" centers. Full 1" thick reinforced doors have full height piano continuous hinges. Three point locking device with plated locking bars. Features two pre-installed handles with the unit arriving fully assembled (1 fixed, 1 locking, 2 keys).

Item #	Product Dimensions	Number of Adjustable Shelves	Color	List Price
6-1386591-670	36 W x 18 D x 42 H in	2	Specify	\$1,034.95
6-1386592-670	36 W x 24 D x 42 H in	2	Specify	\$1,157.95
6-1386593-670	36 W x 18 D x 72 H in	4	Specify	\$1,199.95
6-1386594-670	36 W x 24 D x 72 H in	4	Specify	\$1,544.95
6-1386595-670	36 W x 18 D x 78 H in	4	Specify	\$1,383.95
6-1386596-670	36 W x 24 D x 78 H in	4	Specify	\$1,687.95

### KC Bin Heavy Duty Storage Cabinets

These heavy duty cabinets ship fully assembled and have a 400 lb shelf capacity. Triple flanged shelves are adjustable on 2" centers. Full 1" thick reinforced doors have full height piano continuous hinges. Three point locking device with plated locking bars. Features two pre-installed handles with the unit arriving fully assembled (1 fixed, 1 locking, 2 keys)

Item #	Product Dimensions	Number of Adjustable Shelves	Color	List Price
6-1386605-670	24 W x 18 D x 78 H in	4	Specify	\$1,275.95
6-1386606-670	24 W x 24 D x 78 H in	4	Specify	\$1,404.95
6-1386607-670	36 W x 18 D x 78 H in	4	Specify	\$1,767.95
6-1386608-670	36 W x 24 D x 78 H in	4	Specify	\$1,934.95
6-1386609-670	48 W x 24 D x 78 H in	4	Specify	\$2,439.95



### KC Bin Visual Storage Cabinet

Great cabinet for supplies when security and visibility are necessary. Doors are 16-gauge with full height piano hinges and shatterproof acrylic panels. Two handles provided (1 locking, 1 fixed) furnished with 2 keys. Three point locking device with plated locking bars. Shelves adjust on 2" centers. Ledge cornice top. Durable powder coat finish.

Item #	Product Dimensions	Number of Fixed Shelves	Number of Adjustable Shelves	Color	List Price
6-1386587-670	36 W x 18 D x 72 H in	2	4	Specify	\$1,726.95
6-1386588-670	36 W x 24 D x 72 H in	2	4	Specify	\$1,978.95

### KC Bin Mesh Door Visual Storage Cabinet

Excellent cabinet when ventilation, security and visibility are important. Doors are 16-gauge with expanded metal fronts and full height piano hinges. Shelves are 18-gauge with capacity of 400 lb. each and adjust on 2" centers. Three point locking device with plated locking bars. Two handles (1 locking, 1 fixed) and 2 keys are provided.

Item #	Product Dimensions	Number of Fixed Shelves	Number of Adjustable Shelves	Color	List Price
6-1386589-670	36 W x 18 D x 72 H in	2	4	Specify	\$2,140.95
6-1386590-670	36 W x 24 D x 72 H in	2	4	Specify	\$2,371.95



**KC Bin Colors**

PLEASE SPECIFY COLOR CHOICE

Blue Black Gray Champagne



Additional sizes available.  
Please contact your School  
Specialty Territory Manager.

**KC Bin Industrial Clip Shelving**

These open shelving units are ideal for economical, general purpose storage, allowing both light and free air flow to penetrate a storage areas. Standard side and back sway braces made from 12-gauge steel are used to stabilize open shelving units. Braces are punched to attach to upright posts with nuts and bolts.

The units shown feature Series 2000 medium-duty 20-gauge shelves for standard capacity requirements. Units have angle posts on both front and rear corners. Units ship ready to assemble and include all necessary hardware. Units come standard with 5 shelves (includes top and bottom). Order one starter unit and the balance as adders to make up row of shelving.

Item #	Description	Product Dimensions	Starter/Adder	Number of Shelves	List Price
6-1301731-670	Industrial Clip Shelving	36 W x 12 D x 85 H in	Starter	5	\$730.95
6-1301827-670	Industrial Clip Shelving	36 W x 18 D x 85 H in	Starter	5	\$856.95
6-1301732-670	Industrial Clip Shelving	36 W x 24 D x 85 H in	Starter	5	\$962.95
6-1301733-670	Industrial Clip Shelving	36 W x 12 D x 85 H in	Adder	5	\$696.95
6-1301734-670	Industrial Clip Shelving	36 W x 18 D x 85 H in	Adder	5	\$849.95
6-1301735-670	Industrial Clip Shelving	36 W x 24 D x 85 H in	Adder	5	\$935.95
6-1301736-670	Extra Shelf	36 W x 12 D in	Shelf	1	\$95.95
6-1301737-670	Extra Shelf	36 W x 18 D in	Shelf	1	\$122.95
6-1301738-670	Extra Shelf	36 W x 24 D in	Shelf	1	\$139.95

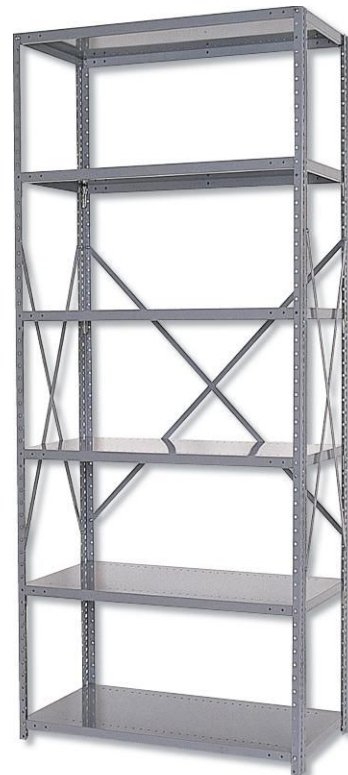

Shown with optional extra shelf

**KC Bin Rivet Wedge-Lock Steel Shelving**

These Rivet Wedge-Lock Steel Shelving units have a greater shelf area than standard units, making them ideal for storing large or odd-sized items. The wide range of shelf sizes and capacities, combined with the option of adding extra shelves, allows you to design the bulk shelving system that best meets your needs.

Units feature 14-gauge heavy duty angle and heavy-duty T-posts. Heavy-duty beams are used full perimeter at all levels on bulk units. Beams are punched to accept front-to-rear supports supplied with units 36" and 48" deep. Units are available with framing only and ship ready to assemble. Order one starter unit and the balance as adders to make up a row of shelving **5/8" particleboard deck sold separately.**

Item #	Description	Product Dimensions	Starter/Adder	Number of Shelves	List Price
6-1393818-670	Wedge-Lock Shelving	48 W x 24 D x 84 H in	Starter	4	\$774.95
6-1393819-670	Rivet Lock Shelving	48 W x 24 D x 84 H in	Adder	4	\$740.95
6-1393820-670	Rivet Lock Shelving	48 W x 36 D x 84 H in	Starter	4	\$894.95
6-1393821-670	Rivet Lock Shelving	48 W x 36 D x 84 H in	Adder	4	\$894.95
6-1393822-670	Rivet Lock Shelving	48 W x 48 D x 84 H in	Starter	4	\$1,006.95
6-1393823-670	Rivet Lock Shelving	48 W x 48 D x 84 H in	Adder	4	\$972.95
6-1393824-670	Rivet Lock Shelving	72 W x 24 D x 84 H in	Starter	4	\$989.95
6-1393825-670	Rivet Lock Shelving	72 W x 24 D x 84 H in	Adder	4	\$969.95
6-1393826-670	Rivet Lock Shelving	72 W x 36 D x 84 H in	Starter	4	\$1,081.95
6-1393827-670	Rivet Lock Shelving	72 W x 36 D x 84 H in	Adder	4	\$938.95
6-1393828-670	Rivet Lock Shelving	72 W x 48 D x 84 H in	Starter	4	\$1,163.95
6-1393829-670	Rivet Lock Shelving	72 W x 48 D x 84 H in	Adder	4	\$1,143.95
6-1393830-670	Rivet Lock Shelving	96 W x 24 D x 84 H in	Starter	4	\$1,269.95
6-1393831-670	Rivet Lock Shelving	96 W x 24 D x 84 H in	Adder	4	\$1,286.95
6-1393832-670	Rivet Lock Shelving	96 W x 36 D x 84 H in	Starter	4	\$1,385.95
6-1393833-670	Rivet Lock Shelving	96 W x 36 D x 84 H in	Adder	4	\$1,385.95
6-1393834-670	Rivet Lock Shelving	96 W x 48 D x 84 H in	Starter	4	\$1,522.95
6-1393835-670	Rivet Lock Shelving	96 W x 48 D x 84 H in	Adder	4	\$1,501.95
6-1304054-670	Particleboard Shelf	48 W x 24 D in	Shelf	1	\$91.95
6-1304055-670	Particleboard Shelf	48 W x 36 D in	Shelf	1	\$125.95
6-1304056-670	Particleboard Shelf	48 W x 48 D in	Shelf	1	\$146.95
6-1304057-670	Particleboard Shelf	72 W x 24 D in	Shelf	1	\$125.95
6-1304058-670	Particleboard Shelf	72 W x 36 D in	Shelf	1	\$149.95
6-1304059-670	Particleboard Shelf	72 W x 48 D in	Shelf	1	\$190.95
6-1304060-670	Particleboard Shelf	96 W x 24 D in	Shelf	1	\$159.95
6-1304061-670	Particleboard Shelf	96 W x 36 D in	Shelf	1	\$187.95
6-1304062-670	Particleboard Shelf	96 W x 48 D in	Shelf	1	\$204.95



Particle Board sold separately.



### Sandusky Lee Z-Beam Boltless Steel Shelving with Particleboard Shelves

Industrial grade steel construction. Z-Beam design for strength and rigidity. Four adjustable shelves. Post coupler for faster and easier assembly. Can be assembled vertically or horizontally. Shelves have 800 lbs. capacity when evenly distributed and adjust on 1-1/2" increments.

Item #	Product Dimensions	Number of Shelves	List Price
6-1591317-670	36 W x 18 D x 60 H in	4	\$224.95
6-1591318-670	30 W x 12 D x 60 H in	5	\$242.95
6-1591319-670	36 W x 18 D x 72 H in	5	\$268.95
6-1591320-670	48 W x 18 D x 72 H in	5	\$305.95
6-1591321-670	48 W x 24 D x 72 H in	5	\$341.95

### Sandusky Lee Wire Shelving

Durable welded wire construction with open design permits sprinkler, air and light penetration and reduces dust build-up. Shelves are adjustable in 1" increments. Includes four 2" nylon casters for easy mobility. Easy to assemble in just minutes without tools.

Item #	Description	Product Dimensions	Number of Shelves	List Price
9-1452418-670	Wire Shelving with Casters	22 W x 13 D x 33 H in	3	\$258.95
9-1449229-670	Mobile Wire Shelving - 5 Tier	30 W x 14 D x 60 H in	5	\$389.95
6-1459951-670	Heavy-Duty Wire Shelving	36 W x 24 D x 74 H in	4	\$606.95
6-1466157-670	Heavy-Duty Wire Shelving	48 W x 24 D x 74 H in	4	\$895.95
6-1459953-670	Heavy-Duty Wire Shelving	72 W x 24 D x 74 H in	4	\$1,194.95



### Quantum Storage Wire Shelving Starter Kits

Heavy duty chrome wire shelf unit allows up to 800 lbs of shelf capacity. Starter kits come complete with 4 posts and 4 shelves.

#### Adder Kits

Additional Adder kit allows you to expand your Starter Kit by sharing a set of posts. Configuration options include straight line, back to back, and right angles (L-Shape). Adder Kits come complete with 2 posts, 4 shelves, and 8 S-Hooks.

Available in Chrome as pictured or flat Black.

Item #	Product Dimensions	Starter/Adder	Color	Number of Shelves	List Price
<b>Starter</b>					
6-1494419-670	36 W x 18 D x 63 H in	Starter	Specify	4	\$542.95
6-1494420-670	48 W x 18 D x 63 H in	Starter	Specify	4	\$657.95
6-1494421-670	60 W x 18 D x 63 H in	Starter	Specify	4	\$826.95
6-1494422-670	72 W x 18 D x 63 H in	Starter	Specify	4	\$935.95
6-1494423-670	36 W x 24 D x 63 H in	Starter	Specify	4	\$655.95
6-1494424-670	48 W x 24 D x 63 H in	Starter	Specify	4	\$791.95
6-1494425-670	60 W x 24 D x 63 H in	Starter	Specify	4	\$1,012.95
6-1494426-670	72 W x 24 D x 63 H in	Starter	Specify	4	\$1,158.95
6-1494430-670	36 W x 18 D x 74 H in	Starter	Specify	4	\$560.95
6-1494428-670	48 W x 18 D x 74 H in	Starter	Specify	4	\$675.95
6-1494429-670	60 W x 18 D x 74 H in	Starter	Specify	4	\$844.95
6-1494430-670	72 W x 18 D x 74 H in	Starter	Specify	4	\$953.95
6-1494431-670	36 W x 24 D x 74 H in	Starter	Specify	4	\$673.95
6-1494432-670	48 W x 24 D x 74 H in	Starter	Specify	4	\$809.95
6-1494433-670	60 W x 24 D x 74 H in	Starter	Specify	4	\$1,030.95
6-1494434-670	72 W x 24 D x 74 H in	Starter	Specify	4	\$1,176.95

Item #	Product Dimensions	Starter/Adder	Color	Number of Shelves	List Price
<b>Adder</b>					
6-1494435-670	36 W x 18 D x 63 H in	Adder	Specify	4	\$478.95
6-1494436-670	48 W x 18 D x 63 H in	Adder	Specify	4	\$593.95
6-1494437-670	60 W x 18 D x 63 H in	Adder	Specify	4	\$762.95
6-1494438-670	72 W x 18 D x 63 H in	Adder	Specify	4	\$871.95
6-1494439-670	36 W x 24 D x 63 H in	Adder	Specify	4	\$591.95
6-1494440-670	48 W x 24 D x 63 H in	Adder	Specify	4	\$727.95
6-1494441-670	60 W x 24 D x 63 H in	Adder	Specify	4	\$949.95
6-1494442-670	72 W x 24 D x 63 H in	Adder	Specify	4	\$1,094.95
6-1494443-670	36 W x 18 D x 74 H in	Adder	Specify	4	\$487.95
6-1494444-670	48 W x 18 D x 74 H in	Adder	Specify	4	\$602.95
6-1494445-670	60 W x 18 D x 74 H in	Adder	Specify	4	\$771.95
6-1494446-670	72 W x 18 D x 74 H in	Adder	Specify	4	\$880.95
6-1494447-670	36 W x 24 D x 74 H in	Adder	Specify	4	\$600.95
6-1494448-670	48 W x 24 D x 74 H in	Adder	Specify	4	\$736.95
6-1494449-670	60 W x 24 D x 74 H in	Adder	Specify	4	\$957.95
6-1494450-670	72 W x 24 D x 74 H in	Adder	Specify	4	\$1,103.95





# facility furnishings



## KC Bin Lockers

Lockers feature heavy 16-gauge steel doors mounted in welded frame assemblies for strength and durability. Reliable recessed handle and proven latching system ensure maximum security, while louvers provide ventilation. Lockers are conveniently available in pre-packaged, 1-wide and 3-wide groupings. Lockers include 6" legs for an overall finished height of 60" or 78". Some assembly required. Additional 5 and 6 High Box units available online.

All sizes available as Quick Ship in Classic Tan or Dove Gray.

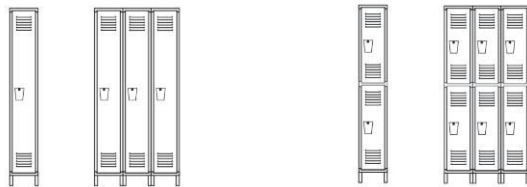

### Single Tier Lockers

### Double Tier Lockers

Item #	Description	Product Dimensions	Color	List Price
<b>Single Tier</b>				
6-1301696-670	Single Tier One Wide	12 W x 12 D x 60 H in	Specify	\$531.95
6-1301697-670	Single Tier Three Wide	12 W x 12 D x 60 H in	Specify	\$1,360.95
6-1301698-670	Single Tier One Wide	12 W x 15 D x 60 H in	Specify	\$567.95
6-1301699-670	Single Tier Three Wide	12 W x 15 D x 60 H in	Specify	\$1,419.95
6-1301700-670	Single Tier One Wide	12 W x 18 D x 60 H in	Specify	\$604.95
6-1301701-670	Single Tier Three Wide	12 W x 18 D x 60 H in	Specify	\$1,486.95
6-1301702-670	Single Tier One Wide	12 W x 12 D x 72 H in	Specify	\$604.95
6-1301703-670	Single Tier Three Wide	12 W x 12 D x 72 H in	Specify	\$1,511.95
6-1301704-670	Single Tier One Wide	12 W x 15 D x 72 H in	Specify	\$629.95
6-1301705-670	Single Tier Three Wide	12 W x 15 D x 72 H in	Specify	\$1,573.95
6-1301706-670	Single Tier One Wide	12 W x 18 D x 72 H in	Specify	\$657.95
6-1301707-670	Single Tier Three Wide	12 W x 18 D x 72 H in	Specify	\$1,662.95
6-1301708-670	Single Tier One Wide	15 W x 18 D x 72 H in	Specify	\$719.95
6-1301709-670	Single Tier Three Wide	15 W x 18 D x 72 H in	Specify	\$1,853.95
<b>Double Tier</b>				
6-1301710-670	Double Tier One Wide	12 W x 12 D x 30 H in	Specify	\$621.95
6-1301711-670	Double Tier Three Wide	12 W x 12 D x 30 H in	Specify	\$1,623.95
6-1301712-670	Double Tier One Wide	12 W x 12 D x 36 H in	Specify	\$679.95
6-1301713-670	Double Tier Three Wide	12 W x 12 D x 36 H in	Specify	\$1,710.95
6-1301714-670	Double Tier One Wide	12 W x 15 D x 36 H in	Specify	\$707.95
6-1301715-670	Double Tier Three Wide	12 W x 15 D x 36 H in	Specify	\$1,808.95
6-1301716-670	Double Tier One Wide	12 W x 18 D x 36 H in	Specify	\$741.95
6-1301717-670	Double Tier Three Wide	12 W x 18 D x 36 H in	Specify	\$1,853.95
6-1301718-670	Double Tier One Wide	15 W x 18 D x 36 H in	Specify	\$794.95
6-1301719-670	Double Tier Three Wide	15 W x 18 D x 36 H in	Specify	\$2,144.95

### Locker Colors

PLEASE SPECIFY COLOR CHOICE

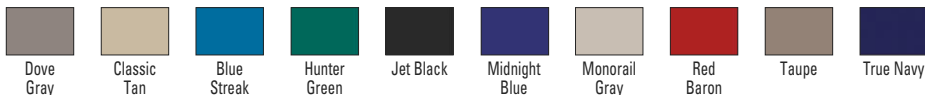



**Screenflex® Portable Room Dividers**

The Standard Room Divider is a lightweight accordion-style portable room divider designed with a strong steel frame, a sound-absorbing core, and self-leveling casters for ease of mobility. Connecting units together creates continuous dividers of any length. Use your divider as a freestanding room partition, temporary wall, sound barrier, portable art display, and much more. NOTE: 1-week Quick Ship fabric colors are Charcoal Black, Stone, and Navy.

Item #	Number of Panels	Product Dimensions	Color	List Price
<b>5'0" Height</b>				
6-674509-670	3	69 W x 60 H in	Specify	\$1,645.95
6-632352-670	5	113 W x 60 H in	Specify	\$2,039.95
6-632355-670	7	157 W x 60 H in	Specify	\$2,588.95
6-632358-670	9	201 W x 60 H in	Specify	\$3,044.95
6-632361-670	11	245 W x 60 H in	Specify	\$3,396.95
6-632364-670	13	289 W x 60 H in	Specify	\$3,985.95
<b>6'0" Height</b>				
6-674510-670	3	69 W x 72 H in	Specify	\$1,834.95
6-632307-670	5	113 W x 72 H in	Specify	\$2,247.95
6-632316-670	7	157 W x 72 H in	Specify	\$2,803.95
6-632325-670	9	201 W x 72 H in	Specify	\$3,313.95
6-632334-670	11	245 W x 72 H in	Specify	\$3,678.95
6-632343-670	13	285 W x 72 H in	Specify	\$4,284.95
<b>6'8" Height</b>				
6-674511-670	3	69 W x 80 H in	Specify	\$2,020.95
6-632310-670	5	113 W x 80 H in	Specify	\$2,560.95
6-632319-670	7	157 W x 80 H in	Specify	\$2,974.95
6-632328-670	9	201 W x 80 H in	Specify	\$3,495.95
6-632337-670	11	245 W x 80 H in	Specify	\$4,118.95
6-632346-670	13	289 W x 80 H in	Specify	\$4,487.95
<b>7'4" Height</b>				
6-674512-670	3	69 W x 88 H in	Specify	\$2,263.95
6-632313-670	5	113 W x 88 H in	Specify	\$2,803.95
6-632322-670	7	157 W x 88 H in	Specify	\$3,367.95
6-632331-670	9	201 W x 88 H in	Specify	\$3,907.95
6-632340-670	11	245 W x 88 H in	Specify	\$4,471.95
6-632349-670	13	289 W x 88 H in	Specify	\$5,035.95
<b>8'0" Height</b>				
6-674513-670	3	69 W x 96 H in	Specify	\$2,532.95
6-632367-670	5	113 W x 96 H in	Specify	\$3,001.95
6-632370-670	7	157 W x 96 H in	Specify	\$3,577.95
6-632373-670	9	201 W x 96 H in	Specify	\$4,123.95
6-632376-670	11	245 W x 96 H in	Specify	\$4,697.95
6-632379-670	13	289 W x 96 H in	Specify	\$5,440.95
<b>Storage Caddy Accessory Bag</b>				
9-1491432-670	-	28 W x 30 H in	Black	\$101.95



**Screenflex Fabric Colors**



PLEASE SPECIFY COLOR CHOICE

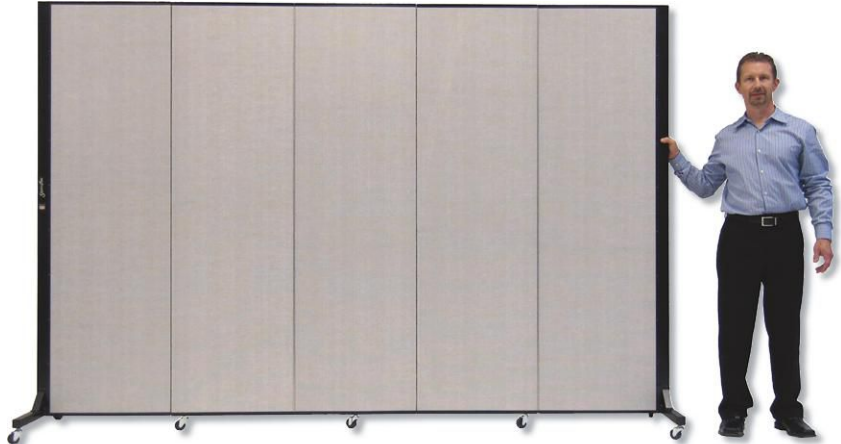

**Screenflex® Simplex Light Duty Room Dividers**

Screenflex® Quality in an economical divider! Easy to set up for a quick solution to dividing space. Stable steel frame holds sound absorbing panels which glide easily on ball bearing casters.

Item #	Description	Number of Panels	Product Dimensions	Color	List Price
6-1365283-670	Light Duty Divider	3	69 W x 77 H in	Specify	\$1,115.95
6-1365284-670	Light Duty Divider	5	113 W x 77 H in	Specify	\$1,475.95



**Screenflex® Whiteboard Portable Partitions**

Portable room divider and display board. One side whiteboard, other side tackable bulletin board. Perfect for in the classroom, media center/library, or other multipurpose space. Flexible for changing needs and programs.

Item #	Description	Product Dimensions	Tackboard Color	List Price
6-1581634-670	Room Divider - 3 Panels	5-3/4 W x 6 H ft	Black	\$3,690.95
6-1581635-670	Room Divider - 5 Panels	9-1/2 W x 6 H ft	Black	\$5,115.95
6-1581636-670	Room Divider - 7 Panels	13-1/2 W x 6 H ft	Black	\$6,541.95
6-1581637-670	Room Divider - 9 Panels	16-3/4 W x 6 H ft	Black	\$8,000.95
6-1581638-670	Room Divider - 11 Panels	20-1/2 W x 6 H ft	Black	\$9,422.95
6-1581639-670	Room Divider - 13 Panels	24-1/2 W x 6 H ft	Black	\$10,848.95



ESSENTIALS BY MOORECO



**Essentials™ by MooreCo® Preschool Dividers**

Preschool Dividers are the ideal portable panel for any early childhood environment. Use the panels as room dividers, acoustical shields, storyboard displays, or to exhibit artwork. Join dividers together to create private learning areas, or to divide rooms into activity areas. Available in easy to clean vinyl, or melamine dry erase surface. Lightweight panel and wide base design create stability. Black anodized aluminum trim. Panels include 2" casters (2 locking).

Item #	Description	Number of Panels	Product Dimensions	Color	List Price
<b>Divider - Two Sided Markerboard</b>					
6-1127881-670	Two Sided Markerboard	1	48 W x 48 H in	White	\$525.95
6-508424-670	Two Sided Markerboard	1	60 W x 48 H in	White	\$821.95
6-508427-670	Two Sided Markerboard	1	72 W x 48 H in	White	\$1,254.95
<b>Divider - Two Sided Vinyl</b>					
6-1442400-670	Two Sided Vinyl	1	48 W x 48 H in	Specify	\$674.95
6-1442404-670	Two Sided Vinyl	1	60 W x 48 H in	Specify	\$690.95
6-1442408-670	Two Sided Vinyl	1	72 W x 48 H in	Specify	\$783.95
<b>Divider - Two Sided Markerboard/Vinyl</b>					
6-1442402-670	Two Sided Markerboard/Vinyl	1	48 W x 48 H in	Specify	\$718.95
6-1442406-670	Two Sided Markerboard/Vinyl	1	60 W x 48 H in	Specify	\$864.95
6-1442410-670	Two Sided Markerboard/Vinyl	1	72 W x 48 H in	Specify	\$1,013.95

**Vin-Tak Colors**







### Lorell® Utility Carts

Utility cart features a two-shelf or three-shelf design to offer a convenient worksurface and spacious storage for your supplies. All shelves are surrounded with a raised lip (3-1/4" high) to keep your contents secure. Industrial strength rolling casters and durable steel construction. Covered by Lorell Limited Lifetime Warranty. Assembly Required.

Item #	Description	Product Dimensions	Capacity	Color	List Price
<b>2-Shelf</b>					
6-2006745-670	Utility Cart	16 W x 30 D x 32 H in	400 lbs	Black	\$314.95
6-2006747-670	Utility Cart	24 W x 36 D x 32 H in	400 lbs	Black	\$417.95
<b>3-Shelf</b>					
6-2025456-670	Utility Cart	16 W x 30 D x 32 H in	400 lbs	Black	\$437.95
6-2025457-670	Utility Cart	24 W x 36 D x 32 H in	400 lbs	Black	\$564.95

## BOSTITCH®

### Bostitch® Stowaway™ Folding Utility Cart

Storage space is the number one user issue with current cart designs. Our Bostitch® Stowaway™ Folding Carts have a patented folding design that stores away in 4x less space! An optional wall mount bracket allows for easy storage behind a door or in an open space. It folds and unfolds in a fraction of a second with secure safety locks for the strongest durability. Dual shelves provide 1300+ square inches of storage space and can hold up to a massive 500 pounds of storage capacity. Durable chrome finish for easy cleaning and lifetime durability with six, medical style no-mar swivel wheels for quiet operation and easy maneuverability.



Item #	Description	Product Dimensions	Color	List Price
5-2026979-670	Folding Cart - Small	19-1/2 W x 31 D x 39 H in	Black	\$463.95
5-2026980-670	Folding Cart - Large	23-1/2 W x 37-1/2 D x 39 H in	Black	\$535.95
5-2026981-670	Folding Cart - Large	23-1/2 W x 37-1/2 D x 39 H in	Chrome	\$642.95



### KC Bin Pallet Jack

The standard pallet (40"W x 48"D) is best handled with a pallet jack that is 27" wide and 48" long (fork length), allowing the load wheels (the small ones) to drop through the bottom of the pallet. This provides full support and balance while remaining maneuverable.

Item #	Description	Product Dimensions	Capacity	List Price
6-1466745-670	Pallet Jack	48 L x 27 W in	5500 lb	\$1,899.95



### Rubbermaid® Commercial Utility Cart

Three-Shelf Utility Cart is ideal for moving equipment from office to conference room. Design features tough, structural web construction; aluminum frame with 4" nonmarking casters and a large 20" x 40" three-shelf work area. Textured surface resists scratching.

Item #	Description	Product Dimensions	Capacity	Color	List Price
6-1313068-670	Utility Cart	40-5/8 W x 20 D x 37-3/4 H in	300 lbs	Black	\$1,098.95
6-1506252-670	Utility Cart	40-5/8 W x 20 D x 37-3/4 H in	300 lbs	Gray	\$1,098.95



### Cramer Kik Step

Rolls when you kick it; holds when you climb! Sturdy steel construction. Wide platform with rubber tread. All-around bumper protects walls and furniture. Non-marking, retractable casters. Base grips floor under slightest pressure. Rolls easily when pressure is released. 14" high.

Item #	Description	Product Height	Quantity	List Price
9-614084-670	Beige Step Stool	14 in	Each	\$208.29
9-679236-670	Black Step Stool	14 in	Each	\$208.29
9-679237-670	Silver Step Stool	14 in	Each	\$208.29
9-679238-670	Grey Step Stool	14 in	Each	\$208.29

**CLASSROOM  
SELECT**

**Classroom Select® Utility Cart**

Durable high density thermoplastic cart has two or three shelves 4 1/4" deep with weight capacity of 250 lbs. per shelf. Includes 4 casters - 2 swivel, 2 fixed. Some assembly required.



Item #	Description	Product Dimensions	Capacity	Color	List Price
6-678771-670	Small Cart - 2 Shelf	17 W x 31 D x 33 H in	500 lb	Gray	\$297.95
6-678772-670	Large Cart - 2 Shelf	25-1/2 W x 37-1/2 D x 33 H in	500 lb	Gray	\$372.95
9-2091193-670	Small Cart - 3 Shelf	17 W x 31 D x 33 H in	750 lb	Gray	\$347.95
9-2091192-670	Large Cart - 3 Shelf	25-1/2 W x 37-1/2 D x 33 H in	750 lb	Gray	\$449.95



**LAKESIDE**

**Lakeland Modular Utility Cart**

Advanced design and modular construction highlight this utility cart. Made of high density polyethylene. Unit has 3, 16" x 24" shelves with upright edges. Modular design allows for assembly in minutes. Capacity is 300 lbs. Overall height, 32.5". Beige color.

Item #	Description	Product Dimensions	List Price
6-569390-670	Plastic Utility Cart	17-1/8W x 32-1/2D x 34-7/8H in	\$788.95

**LAKESIDE**

**Stainless Steel Utility Carts**

Durable, unitized, electronically welded stainless steel angle leg frame with bumpers to protect walls and furniture. Stainless steel construction allows for easy cleaning. Sound deadening panels under shelves reduce noise and vibration. Cart has 3 fixed-position shelves—top 2 shelves have 1" rail edge on 3 sides. Standard Duty carts have 3 1/2" swivel casters and 300 lb capacity; Heavy Duty cart has 4" swivel casters and 500 lb capacity.



Item #	Description	Product Dimensions	Color	List Price
6-586263-670	Utility Cart - Standard Duty	16-1/4W x 27-1/2D x 32-1/8H in	Silver	\$638.95
6-1452982-670	Utility Cart - Standard Duty	18-3/8 W x 30-3/4 D x 33 H in	Silver	\$738.95
6-586269-670	Utility Cart - Heavy Duty	31 W x 19 D x 32 H in	Silver	\$998.95



PLEASE SPECIFY COLOR CHOICE

**Utility Carts Color**



**Quantum Storage Wire Utility Carts**

Wire utility cart has swivel casters, shelves, and two ergonomically positioned U-shaped handles; suitable for sorting, storing, and transporting items. Wire shelves are made of welded steel and reinforced with wire trusses for strength. Shelves adjust in 1" increments to accommodate items of varying height. Four 5" polyurethane swivel casters with brakes on two of them for control and maneuverability. Four non-marking rubber donut bumpers help protect walls and furniture from damage. Has an 800 lb. per shelf capacity, total cart capacity not to exceed 1,200 lbs.

Item #	Description	Product Dimensions	Color	List Price
5-1494451-670	2 Shelf	18 W x 36 D x 37-1/2 H in	Specify	\$503.95
5-1494452-670	2 Shelf	18 W x 42 D x 37-1/2 H in	Specify	\$527.95
5-1494453-670	2 Shelf	18 W x 48 D x 37-1/2 H in	Specify	\$555.95
5-1494454-670	2 Shelf	24 W x 36 D x 37-1/2 H in	Specify	\$570.95
5-1494455-670	2 Shelf	24 W x 42 D x 37-1/2 H in	Specify	\$597.95
5-1494456-670	2 Shelf	24 W x 48 D x 37-1/2 H in	Specify	\$631.95
5-1494457-670	3 Shelf	18 W x 36 D x 37-1/2 H in	Specify	\$588.95
5-1494458-670	3 Shelf	18 W x 42 D x 37-1/2 H in	Specify	\$625.95
5-1494459-670	3 Shelf	18 W x 48 D x 37-1/2 H in	Specify	\$666.95
5-1494460-670	3 Shelf	24 W x 36 D x 37-1/2 H in	Specify	\$681.95
5-1494461-670	3 Shelf	24 W x 42 D x 37-1/2 H in	Specify	\$721.95
5-1494462-670	3 Shelf	24 W x 48 D x 37-1/2 H in	Specify	\$833.95



SuperScrape® Plus

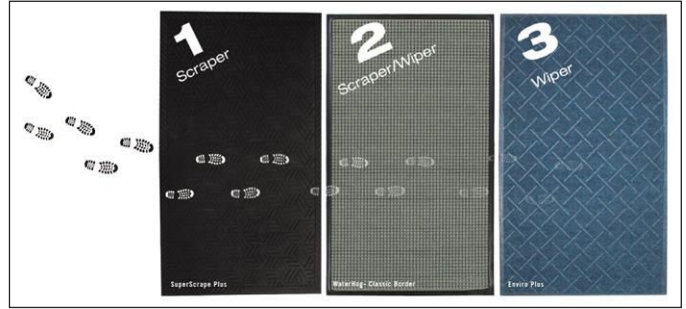

### SuperScrape® Plus Mat

#### Scrapper Mat

The SuperScrape® Plus mat features a multi-directional molded tread pattern that effectively scrapes tough dirt and grime from shoes. The unique drainable borders help filter water off the mat, making it perfect for outside use as a scrapper mat or as a slipresistant mat in wet areas.

Item #	Description	Product Dimensions	Color	List Price
9-2010566-670	SuperScrape Floor Mat	2-1/2 W x 3 H ft	Black	\$79.95
9-2010565-670	SuperScrape Floor Mat	3 W x 5 H ft	Black	\$150.95
9-2010568-670	SuperScrape Floor Mat	4 W x 6 H ft	Black	\$236.95
9-2010567-670	SuperScrape Floor Mat	3 W x 10 H ft	Black	\$297.95

### WaterHog® Mats

#### Scrapper/Wiper Mats

WaterHog® mats are durable, stain-resistant mats with a unique bi-level design that traps dirt beneath shoe level, and a water dam border that holds moisture keeping it off your floors for a clean, dry and safe facility. PET fabric is made from 100% post-consumer recycled plastic from drink bottles. Available in multiple surface patterns and various colors.



WaterHog® Eco Elite

Item #	Product Dimensions	Color	Quantity	List Price
<b>WaterHog Diamond</b>				
9-1376151-670	2 W x 3 H ft	Specify	Each	\$56.95
9-086914-670	3 W x 5 H ft	Specify	Each	\$135.95
9-086916-670	3 W x 10 H ft	Specify	Each	\$278.95
9-1376152-670	4 W x 6 H ft	Specify	Each	\$222.95
9-1376153-670	4 W x 8 H ft	Specify	Each	\$341.95
9-086918-670	4 W x 10 H ft	Specify	Each	\$365.95
<b>WaterHog</b>				
9-1376147-670	2 W x 3 H ft	Specify	Each	\$55.95
9-086943-670	3 W x 5 H ft	Specify	Each	\$137.95
9-086945-670	3 W x 10 H ft	Specify	Each	\$279.95
9-086947-670	4 W x 6 H ft	Specify	Each	\$223.95

Item #	Product Dimensions	Color	Quantity	List Price
<b>WaterHog</b>				
9-086948-670	4 W x 8 H ft	Specify	Each	\$335.95
9-086949-670	4 W x 10 H ft	Specify	Each	\$366.95
9-1376154-670	6 W x 6 H ft	Specify	Each	\$477.95
9-1376155-670	6 W x 8 H ft	Specify	Each	\$503.95
<b>WaterHog Eco Elite</b>				
9-5003826-670	2 W x 3 H ft	Specify	Each	\$64.95
9-5003830-670	3 W x 10 H ft	Specify	Each	\$318.95
9-5003827-670	4 W x 8 H ft	Specify	Each	\$397.95
9-5003829-670	4 W x 10 H ft	Specify	Each	\$428.95
9-5003831-670	6 W x 6 H ft	Specify	Each	\$373.95
9-5003828-670	6 W x 8 H ft	Specify	Each	\$525.95
9-5003832-670	6 W x 8 H ft	Specify	Each	\$620.95

#### WaterHog Patterns

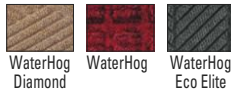

#### WaterHog Eco Color



#### WaterHog Colors

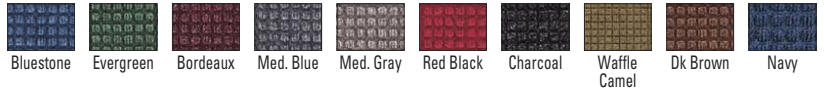

PLEASE SPECIFY COLOR CHOICE

For more customized options, please contact your Sales Rep.

### Comfort Flow™ Mat

The Comfort Flow™ is a flow through mat with excellent anti-fatigue properties designed for wet areas. This light-weight mat provides beveled edges a safe transition from floor to mat; certified high-traction by the National Floor Safety Institute (NFSI). It features high-density closed cell nitrile rubber cushion provides excellent anti-fatigue qualities. It is a grease proof mat which allows the flow of liquid and its anti-microbial properties protects against odors and degradation.



Item #	Description	Product Dimensions	List Price
9-1376143-670	Anti Fatigue Floor Mat	2 W x 3 H ft	\$89.95
5-1376144-670	Anti Fatigue Floor Mat	3 W x 5 H ft	\$175.95
5-1376145-670	Anti Fatigue Floor Mat	4 W x 6 H ft	\$280.95
5-1376146-670	Anti Fatigue Floor Mat	3 W x 9 H ft	\$350.95





# safety & security



### AIR QUALITY MONITORING

- Detection of vaping and smoking
- Detection of dangerous chemicals
- Temperature and humidity
- Monitoring of the room's Air Quality Index to warn when air quality reaches unhealthy levels



### SOUND FREQUENCY MONITORING

- Detection of aggressive behavior
- Detection of gunshots
- Recognition of keywords that can be used to call for help



### ALERTING

- Email or SMS text alerts
- Monitoring the sanitizing of rooms
- Detection of tampering
- Alerts to Video Management & Access Control
- Low voltage relay outputs



### CHEMICAL DETECTION

- Volatile organic compounds (VOCs)
- Whippets (Nitrous Oxide)
- Hydrogen levels
- Ammonia
- Carbon Dioxide
- Carbon Monoxide (CO<sub>2</sub>)
- Nitrogen
- THC



### ROOM OCCUPANCY

- Light detection



### HALO CLOUD DASHBOARD\*

- Facility-wide trend analysis and reporting
- Real-time and historical event monitoring

## HALO Smart Sensor

HALO Smart Sensor is your all-in-one to combat infectious disease. Detects vape & THC, temperature, chemical detection, loud disturbances, and more. HALO can alert staff through the web, video management systems, or building management tools. Plus, the HALO Cloud option\* lets you manage multiple HALOs at once monitoring system for hazards to school health and security. It tracks air quality and detects trends and generate reports for your whole facility. Additional training and extended warranties available. Please contact your School Specialty Representative.

Item #	Description	Quantity	List Price
9-2093106-670	Smart Sensor - 2C	Each	\$2,040.95
9-2028297-670	Surface Mount Adaptor	Each	\$201.95





MA-25



MA-40



MA-50



MA-112

**Medify Air Purifiers**

Medify Air Purifier with H13 True HEPA Filter that captures at least 99.9% of the smallest particles (0.1 microns). A purification system is the perfect choice for every room effectively removing harmful toxins, allergens, dust, pollen, mold, bacteria, and viruses. The clean air exchange ranges from 330 sq ft - 2,500 sq ft every 30 minutes based on the selected air purifier.

Item #	Description	Coverage	List Price
5-2087552-670	Air Purifier - MA-15 - Silver	330 sq ft	\$222.49
5-2087530-670	Air Purifier - MA-15 - White	330 sq ft	\$222.49
5-2087533-670	Air Purifier - MA-25 - Black	500 sq ft	\$285.69
5-2087540-670	Air Purifier - MA-25 - Silver	500 sq ft	\$285.69
5-2087539-670	Air Purifier - MA-25 - White	500 sq ft	\$285.69
5-2087544-670	Air Purifier - MA-40 - Black	840 sq ft	\$482.09
5-2087547-670	Air Purifier - MA-40 - White	840 sq ft	\$482.09
5-2090194-670	Air Purifier - MA-50 - White	1100 sq ft	\$580.29
5-2087545-670	Air Purifier - MA-112 - White	2500 sq ft	\$1,229.09

Item #	Description	Coverage	List Price
<b>Replacement Filters</b>			
9-2087549-670	Filter - MA-15	-	\$71.39
9-2087551-670	Filter - MA-25	-	\$89.29
9-2087537-670	Filter - MA-40	-	\$107.09
9-2091174-670	Filter - MA-50	-	\$146.95
9-2087543-670	Filter - MA-112	-	\$248.19



Trio Plus



Trio Pro

**Field Controls Air Purifiers**

Field Control's Trio maximizes airflow into one powerful, quiet, and efficient portable system. A complete purification system providing added protection for homes, schools, and any workplace. This portable, powerful air purification and filtration system captures 99.97% of particles like dust, pollen, mold, bacteria, and viruses.

Item #	Description	Coverage	List Price
6-2083070-670	Air Purifier - Trio Plus	1100 sq ft	\$1,751.95
6-2087649-670	Air Purifier - Trio Pro	1618 sq ft	\$2,250.95
<b>Accessories</b>			
9-2083077-670	Lamps - Trio Plus	-	\$124.95
9-2083080-670	Filter - Trio Plus Set	-	\$152.95
9-2094565-670	Filter - Trio Pro Set	-	\$239.95



**Copernicus Air Purifiers**

Copernicus Dual True HEPA Filters that capture at least 99.97% of the smallest particles (0.3 microns). The clean air delivery rate (CADR) is 365 cubic feet per minute and AIR1 can improve classroom HVAC air changes per hour by over 5 times! Quiet! Approximately 44dB (normal conversation noise level) at 6 ½ ft from unit.

Item #	Description	Coverage	List Price
6-2090611-670	Air Purifier - Air1	750 sq ft	\$1,549.95
5-2090610-670	Filter - Air1 Set	-	\$227.95

Programming requirements differ based on customer needs. Please contact us for more information before purchasing to determine what is right for you.



**MIDLAND BizTalk® BR200 Business Radio**

The BizTalk® BR200 Business Radio is built for your school communication demands. Designed for professional environments that depend on reliable two-way communication, the BR200 is engineered for push-button communication in large areas, like a 2-story school or a 250,000 sq. ft. school. At nearly half the cost of other communication radios, the BR200 has become a popular option for schools seeking streamlined education communications.



Item #	Description	Model Number	Number of Channels	Warranty	Quantity	List Price
9-1608932-670	BizTalk Radio	BR200	16	1 YEAR LIMITED	Each	\$160.95



**Motorola Digital Two-Way Radio**

The Motorola CP100d Series is a range of practical, entry-level digital radios for professionals wanting to communicate with greater ease and efficiency. The affordable CP100D radios offer all the benefits of digital technology- up to 35% longer talk-time, twice the voice capacity in a 12.5 kHz licensed channel, wider radio coverage and superior audio comes with 16 channels.



Item #	Description	Model Number	Number of Channels	Warranty	Quantity	List Price
9-2103071-670	Two Way Radio	AAH87YDC9JAZAN	16	2 YEAR LIMITED	Each	\$923.95



**Motorola CLS Two-Way Radios**

Full featured two-way radio in a compact size. Uses commercial business frequencies to avoid interference from recreational radio users. Covers buildings up to 200,000 sq. ft. 1-watt power, 56 built-in UHF frequencies, 121 privacy codes. Audio accessory jack for optional earpieces or speaker/mic. Includes radio, quick release swivel belt clip, desktop charger, 14 hour Li-Ion battery. 4" x 2" x 1" in, 4.6 oz.



Item #	Description	Model Number	Number of Channels	Warranty	Quantity	List Price
9-1283303-670	UHF, LCD display	CLS1110	1	2 YEAR	Each	\$329.95
9-1283302-670	UHF, LCD display	CLS1410	4	2 YEAR	Each	\$367.95



**Motorola RD Series Radios**

Rugged die-cast chassis for durability. Meets Military Standards for high resistance to dust, moisture, shock and vibration. Operates on commercial business frequencies. Covers buildings up to 350,000 sq. ft. 4-watt power, 89 built-in UHF frequencies, 219 privacy codes. Audio accessory jack for optional earpieces or speaker/mic. Programmable for use with repeaters, base stations and district wide systems. Model RDU4160d with LCD displays, user and workgroup name and battery level. Includes radio, belt clip, desktop charger, 18 hour Li-Ion battery. 4-1/2" x 2" x 2 inches, 10.3 oz.



Item #	Description	Model Number	Number of Channels	Warranty	Quantity	List Price
9-1283298-670	UHF	RDU4100	10	2 YEAR	Each	\$740.95
9-1283299-670	UHF, LCD display	RDU4160D	16	2 YEAR	Each	\$839.95



**MIDLAND BizTalk® 6 Pack Bundle**

Keep your school's communication organized and at the ready. The BR200X6BGC Bundle features six of Midland's BR200 Business Radios along with a six-radio capacity gang charger that easily houses and recharges up to six radios at once. Indicator lights on the gang charger show when radios are fully charged and ready for use.



Item #	Description	Model Number	Number of Channels	Warranty	Quantity	List Price
9-1608934-670	BizTalk Radio Bundle	BR200X6BGC	16	1 YEAR LIMITED	Pack of 6	\$981.95



**MIDLAND® BR180 Lightweight 2-Way Radios**

The Midland Two-Way Radio BR180 is a small, lightweight hand held portable 2-way radio designed for clear communication. This Two-Way radio has 4 channels and 1-watt power. The BR180 comes with 99 channel options and 142 privacy codes accessible through the programming cable or menu button. This model offers channel scan, hands free VOX mode, rapid charge, and an LCD display. Powered by a Rechargeable Lithium Ion batteries (included).



Item #	Description	Model Number	Number of Channels	Warranty	Quantity	List Price
9-2096480-670	Radio	BR180	4	2 YEAR	Each	\$158.95
9-2040575-670	Radio Bundle	BR180X6BGC	4	2 YEAR	Pack of 6	\$844.95



**Motorola RM Series Two-Way Radios**

Rugged die-cast chassis for long life yet light enough for all day use. Uses commercial business frequencies. Covers buildings up to 250,000 sq. ft. with 2-watt power, 90 built-in UHF frequencies, 219 privacy codes. Audio accessory jack for optional earpieces or speaker/mic. Model RMU2080d includes built-in NOAA weather radio, LCD displays, username and battery level. Includes radio, quick release swivel belt clip, desktop charger, 15 hour Li-Ion battery.



Item #	Description	Model Number	Number of Channels	Warranty	Quantity	List Price
9-1464996-670	UHF	RMU2040	4	2 YEAR	Each	\$518.95
9-1464997-670	UHF, Weather, LCD	RMU2080D	8	2 YEAR	Each	\$765.95



**Motorola Talkabout T460 Two-Way Radios**

Motorola GMRS-FRS recreational two-way radio, 35 mile line of sight range, 22 channels, 121 privacy codes, 11 weather channels (7 NOAA) built-in flashlight, 20 call tones, low battery alert, includes rechargeable NIMH battery and charger.



Item #	Description	Model Number	Number of Channels	Warranty	Quantity	List Price
9-1576100-670	UHF LCD Display	T460	22	1 YEAR	Pack of 2	\$217.95





**ZKTeco Metal Detectors**

ZKTeco Metal Detectors create an extra layer of security for your school, office, stadium or venue. The handheld metal detector is the perfect solution for providing rapid and accurate scanning without body contact. All walk-through units have sound and LED alarms on both sides, which clearly indicate where metal is detected by zone. Each zone can be adjusted for sensitivity based on security needs. All units are easy to assemble and automatically counts people and alarms. These units are created for secure operation and are designed to run self-diagnostics and re-calibrations with each power-on; only authorized personnel can access the control panel.

- **Portable Walk-Through:** the security industry's only foldable walk-through metal detector which includes built-in rollers and a 40-hour rechargeable battery
- **18 Zone:** sensitivity for each zone is adjustable from 0-255, 5.7" LCD screen and infrared remote control.
- **33 Zone:** sensitivity for each zone is adjustable from 0-300, 5.7" LCD screen, infrared remote, wheel accessory set compatible.

Item #	Description	Product Dimensions	List Price
A 9-2004189-670	Hand-Held Metal Detector	3-1/2 W x 16 D x 2 H in	\$309.95
B 6-2004191-670	18 Zone Walk-Through	32 W x 23 D x 87 H in	\$4,467.95
C 6-2004192-670	33 Zone Walk-Through	37 W x 30 D x 87 H in	\$8,644.95
D 6-2028093-670	Portable Walk-Through	36 W x 23 D x 88 H in	\$10,131.95



Custom Sizes Available!

Includes Weighted Hem-Bar for fast deployment

**Lockdown Window Shades**

A Lockdown Window Shade is a simple, cost effective solution to school safety needs. This safety shade is designed to cover windows in the event of an emergency and includes a weighted hem-bar for fast deployment. Offers high quality, flame retardant, opaque woven polyester. Easy to install and fast, one hand deployment when in use.

Item #	Description	Dimensions	List Price
9-2028310-670	For Windows 5" x 30" or Less	8 W x 36 L in	\$29.95
9-2028311-670	For Windows 7" x 37" or Less	10 W x 42 L in	\$37.95
9-2028312-670	For Windows 9" x 37" or Less	12 W x 42 L in	\$40.95
9-2028314-670	For Windows 11" x 37" or Less	14 W x 42 L in	\$47.95
9-2028315-670	For Windows 13" x 37" or Less	16 W x 42 L in	\$55.95



**Quick Action Lockdown Mortise Locks**

Instantly dead bolt doors and maintain 100% code compliance with these deadbolt mortise locks. These locks function as a regular classroom lock for everyday use. When there is a need for a lockdown, pressing the red button instantly throws the deadbolt to the locked position. Type 1 locks, the outside lever does not change when the red button is pressed. Type 2 locks, pressing the red button automatically locks the exterior lever. Use on doors with 8" Mortise Openings. Requires 2 Mortise Cylinders. Add the electrified wireless remote as an additional lockdown option!

Item #	Description	Quantity	List Price
<b>Interior and Exterior Cylinder Operation, depressing interior lever unlocks exterior lever</b>			
9-1545343-670	Left Hand	Each	\$1,365.95
9-1545344-670	Right Hand	Each	\$1,365.95
9-1545345-670	Left Hand Reverse	Each	\$1,365.95
9-1545346-670	Right Hand Reverse	Each	\$1,365.95
<b>Interior and Exterior Cylinder Operation, exterior lever remains locked until released by key</b>			
9-1545351-670	Left Hand	Each	\$1,365.95
9-1545352-670	Right Hand	Each	\$1,365.95
9-1545353-670	Left Hand Reverse	Each	\$1,365.95
9-1545354-670	Right Hand Reverse	Each	\$1,365.95
<b>Exterior Cylinder Operation Only, depressing interior lever unlocks exterior lever remains locked until released by key</b>			
9-1565669-670	Left Hand	Each	\$1,365.95
9-1565670-670	Right Hand	Each	\$1,365.95
9-1565671-670	Left Hand Reverse	Each	\$1,365.95
9-1565672-670	Right Hand Reverse	Each	\$1,365.95
<b>Exterior Cylinder Operation Only, exterior lever remains locked until released by key</b>			
9-1565673-670	Left Hand	Each	\$1,365.95
9-1565674-670	Right Hand	Each	\$1,365.95
9-1565675-670	Left Hand Reverse	Each	\$1,365.95
9-1565676-670	Right Hand Reverse	Each	\$1,365.95
9-1545355-670	Standard Mortise Cylinder	Each	\$59.95
<b>Interchangeable Cores</b>			
9-1545357-670	SFIC Mortise Cylinder Housing	Each	\$99.95
9-1545356-670	Interchangeable Core Mortise	Each	\$197.95
<b>Wireless Remote</b>			
9-2021176-670	Electrified Wireless Remote	Each	\$112.95



**Quick Action Lockdown Cylindrical Locks**  
**Innovative Locking Systems for Enhanced Safety!**

Deadbolt doors instantly and maintain 100% code compliance. These locks function as a regular classroom lock for everyday use. When there is a need for a lockdown, pressing the red button instantly throws the deadbolt to the locked position. Used on doors with cylindrical lock openings. Key and knob cylinders or removable cores required for lever(s). The red button does not affect the outside lever.

**Red Button Locks**



Exterior

Interior



Item #	Description	Quantity	List Price
<b>Exterior Cylinder Only, removable core cylinder operation</b>			
9-1565677-670	Left Hand	Each	\$1,365.95
9-1565678-670	Right Hand	Each	\$1,365.95
9-1565679-670	Left Hand Reverse	Each	\$1,365.95
9-1565680-670	Right Hand Reverse	Each	\$1,365.95
<b>Interior and Exterior Cylinders, removable core cylinder operation</b>			
9-1545347-670	Left Hand	Each	\$1,365.95
9-1545348-670	Right Hand	Each	\$1,365.95
9-1545349-670	Left Hand Reverse	Each	\$1,365.95
9-1545350-670	Right Hand Reverse	Each	\$1,365.95
<b>Exterior Cylinder Only, standard key-in-knob cylinder operation</b>			
9-1565685-670	Left Hand	Each	\$1,365.95
9-1565722-670	Right Hand	Each	\$1,365.95
9-1565723-670	Left Hand Reverse	Each	\$1,365.95
9-1565724-670	Right Hand Reverse	Each	\$1,365.95
<b>Interior and Exterior Cylinders, standard key-in-knob cylinder operation</b>			
9-1565681-670	Left Hand	Each	\$1,365.95
9-1565682-670	Right Hand	Each	\$1,365.95
9-1565683-670	Left Hand Reverse	Each	\$1,365.95
9-1565684-670	Right Hand Reverse	Each	\$1,365.95
<b>Interchangeable Cores</b>			
9-1545356-670	Interchangeable Core Mortise	Each	\$197.95
9-1545357-670	SFIC Mortise Cylinder Housing	Each	\$99.95



Exterior

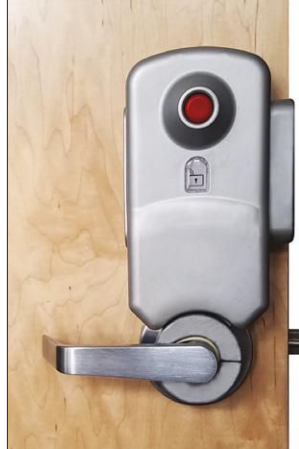

Interior



Interior with Lock Extended



Inswing Door Strike



Template Tool

Core Not Included

Lever Activated Speedy Lockdown

- Safe for Faculty & Students.
- Bolt against Assailants
- Affordable, Easy to Install, with Greater Functionality!

Red Button Locks



QUICKBOLT™ Instant Lockdown Locks

Keep your existing cylindrical locks and add the quickest barricade method!

These locks provide instant bolting of the door with a press of the red button, and installs over cylindrical lever locksets. Maintains single motion free egress at all times, and is 100% Code Compliant. Thru-bolted steel housing with heavy stainless steel bolt, adapter to existing lever, flame-retardant glass fiber nylon cover. Lock status indicator window turns red when lockdown is activated, and can be easily seen from across a room. Metal installation template ensures accurate and fast installations for interfacing with all popular cylindrical locks. Quickbolt can be unlocked at any time via any standard or high security rim cylinder and greatly increases the security of your doors while focusing on life safety. It can also be used as a code-compliant after hours lock. Rim cylinder required, (standard or removable core) but not included.

Item #	Description	Quantity	List Price
9-2000707-670	Left Hand	Each	\$653.95
9-2000711-670	Right Hand	Each	\$653.95
9-2002194-670	Left Hand Reverse	Each	\$653.95
9-2002195-670	Right Hand Reverse	Each	\$653.95
9-2002196-670	Template Tool	Each	\$58.95

LEXI Lockdown™

The LEXI™ Lockdown offers enhanced safety and security in larger multi-door spaces. While the multi-door lockdown lock functions as an everyday passage lock in the day, the exit devices can be deadbolted in case of an emergency. The intruder defense system signals green, white, and red to easily distinguish the lock's status from afar. The LEXI™ trim retrofits all major manufacturers, allowing for a consistent and sleek aesthetic exterior lever. The Controller and Power Supply integrates with LEXI™ lockdown stations and requires 100V AC. The LEXI™ Lockdown is 100% code compliant and focuses on the life, safety and security of the occupants inside the room.

Item #	Description	Quantity	List Price
9-1585902-670	Right Hand Reverse	Each	\$1,842.95
9-1585903-670	Left Hand Reverse	Each	\$1,842.95
6-1589701-670	4 Door Controller/Power Supply	Each	\$1,140.95
9-1585900-670	Door Loop	Each	\$130.95
9-1585906-670	Surface Mount Enclosure	Each	\$142.95
9-1585905-670	Emergency Lockdown Station	Each	\$488.95
6-1589696-670	18" Power Cord & Enclosure	Each	\$492.95
6-1589697-670	Desk Mounted Station	Each	\$632.95





**Master Lock®  
Combination Dial Padlock**

Standard Dial Combination Padlock features a 1-7/8 in (48 mm) wide metal body for durability, with a stainless steel cover. The 9/32 in (7 mm) diameter shackle is 3/4 in (19 mm) long and made of hardened steel, offering extra resistance to cutting and sawing. The 3-digit combination offers keyless convenience. The locking mechanism features anti-shim technology, offering maximum security. Best used for cabinets, school, employee, athletic, and storage lockers. The Limited Lifetime Warranty provides peace of mind.



Item #	Description	Quantity	List Price
9-1063989-670	Combination Dial Lock	Each	\$13.95



**Master Lock® Key Controlled  
Combination Padlocks**

Proven effective in deterring storage of drugs and stolen property in school lockers. This 3-digit combination padlock includes key control feature for supervisory access with master control key can open lock from back, along with many enhanced security features like the exclusive BlockGuard® Anti-Shim technology, hardened steel shackles and double-reinforced stainless steel casing. Designed to fit lockers with a padlock eye of at least 5/16in (8mm) diameter. Factory-kept installation record provides for extension of your present numbering system under same key. You must furnish series number (stamped on your key) if extending current system. Specify "New" or "Existing" series. Specify color choice: black, blue or red.



Item #	Description	Color	Quantity	List Price
9-1137294-670	Combination Padlock With Key	Specify	Each	\$21.95
9-5009447-670	Combination Padlock With Key	Black	Each	\$21.95
9-1137297-670	Control Key	-	Each	\$13.95



**Master Lock® Letter Lock Combination Padlocks**

Lock is available in the following colors: Black, Red, Orange, Gold, Green, Blue, Purple, and Gray. Choose from locks with control chart or locks with control chart and key override. Authorized master control key holder can open lock from back. Factory-kept installation record provides for extension of your present numbering system under same key. You must furnish series number (stamped on your key) if extending current system. Specify "New" or "Existing" series.

Item #	Description	Color	Quantity	List Price
9-1442070-670	Lock with Key Override	Specify	Each	\$16.95
9-1137297-670	Control Key	-	Each	\$13.95



**Zephyr Combination Padlock**

This combination padlock is the go-to lock for schools and universities. The stainless steel body provides greater security and durability to help protect personal belongings. Approved by all lock manufacturers, this lock is an incredibly durable, easy-to-use, and cost-effective locking solution for virtually all lockers.

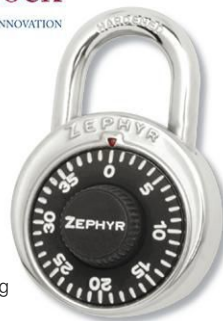

Item #	Description	Quantity	List Price
9-1605659-670	Combination Lock	Pack of 10	\$137.95



**Zephyr Lock Key  
Controlled Combination Padlock**

This lock offers security and durability, as well as allows for supervisory key control that can override the set combination. The stainless steel body and hardened steel shackle make this lock a widely used and highly dependable lock for whatever your locker needs are.



Item #	Description	Color	Quantity	List Price
9-1605658-670	Key Controlled Combo Lock	Black	Pack of 10	\$157.95
9-5009124-670	Control Key (Specify)	Silver	Each	\$7.95



**Zephyr Built in Combination Locks**

For increased security and durability all locks feature an ergonomic dial, complete with a grip ring and non-slip coating. The manual deadbolt series are an ideal choice for ventilated lockers where security can be an issue and require the user to manually turn the dial to lock the door. The spring latch series locks come with seven pre-set combinations and has a longer lifetime than your average combination lock. Both the spring latch and vertical series locks offer automatic locking for a convenient, secure way to lock up belongings. Master key is not included and sold separately.

Item #	Description	Color	Key Series	Quantity	List Price
<b>Vertical Dead Bolt Series</b>					
5-2100633-670	Vertical - Left	Black	-	Pack of 10	\$212.95
5-2100637-670	Vertical - Right	Black	-	Pack of 10	\$212.95
<b>Spring Latch Series</b>					
5-2100634-670	Spring - Left	Black	-	Pack of 10	\$226.95
5-2100632-670	Spring - Right	Black	-	Pack of 10	\$226.95
<b>Manual Dead Bolt Series</b>					
5-2100636-670	Manual - Left	Black	-	Pack of 10	\$240.95
5-2100635-670	Manual - Right	Black	-	Pack of 10	\$240.95
<b>Master Key</b>					
5-5009123-670	Control Key (Specify)	Silver	Specify	Each	\$7.95



CLASSROOM  
SELECT

**Royal Seating™ Recovery Lounge**

Keep individuals comfortable with these durable, easy to clean recovery lounges. Supported by a full perimeter frame of 16-gauge steel, each 72"L x 26"W lounge features a 4" thick polyfoam pad with vinyl covering. A detachable slant pillow, which measures 18"W x 25"L x 6"D, is included. The Apollo legs are constructed of 2" 17-gauge tubing with 18-gauge chrome plated inserts. Legs adjust in 1" increments from 18-5/8" to 27-5/8" high and include a durable, rubber boot to protect flooring.

Item #	Product Dimensions	Material Type	Color	Frame Color	List Price
6-1503646-670	26-1/4 W x 72 D x 22-3/4 H in	Polyfoam	Navy Vinyl	Black	\$670.95
<b>Paper Dispenser</b>					
5-1503667-670	5 W x 24 L in	-	-	-	\$86.95
<b>Examination Paper Roll</b>					
9-1503666-670	5 W x 24 D x 4-1/2 H in	-	-	-	\$35.95



CLASSROOM  
SELECT

**Classroom Select® Pneumatic Stool**

This Stool is a great cost-effective stool for any environment especially in ones where space is limited. This 360-degree swivel stool features a 16-inch round seat cushion, in an easy to clean vinyl fabric. A durable chrome finish pneumatic lift base offers height adjustments from 17 to 22-1/2 inches. This stool features 2-inch dual-wheel casters perfect for any floor surface.

Item #	Product Dimensions	Seat And Back Color	Frame Color	List Price
6-2051242-670	23 W x 23 D x 22-1/2 H in	Black	Chrome	\$199.95



**Sandusky Lee® Value Line Storage Cabinets**

Cabinet features cam-locking handle, welded steel construction and a powder coat finish. Handles require assembly. Meets ANSI/BIFMA shelf standards. Fixed-shelf count includes bottom shelf. Available in dove gray, putty, and black.

Item #	Product Dimensions	Number of Fixed Shelves	Color	List Price
6-1499016-670	30 W x 15 D x 66 H in	4	Specify	\$802.95
6-1438327-670	30 W x 18 D x 72 H in	4	Specify	\$864.95
6-1499017-670	36 W x 18 D x 72 H in	5	Specify	\$977.95



**School Health® Junior Wheelchair**

Comfortable chair with upholstered, padded armrests. Standard dual axle allows for easy adjustment of seat height to hemi level. Durable mag-style composite wheels. 8" caster, 24" rear wheel Carbon steel frame with rust- and chip-resistant chrome plating. It features swing-away detachable leg rests with padded calf pads. It locks the leg rests firmly in place using notched, stainless bar. 300 lbs. weight capacity, 20" seat to floor height and foldable for easy transport.

Item #	Description	List Price
9-1137681-670	16" Junior Seat	\$517.95



**Sandusky Lee® Wall Cabinets**

Solid Door Wall Cabinet has a fully adjustable shelf on 2" centers plus raised bottom shelf. Three point door locking system. Meets ANSI/BIFMA shelf standards. Ships assembled with the exception of the handle which requires slight assembly. Available in dove gray, putty, and black.

Item #	Description	Product Dimensions	Number of Fixed Shelves	Number of Adjustable Shelves	Color	List Price
6-1438287-670	Solid Door Wall Cabinet	18 W x 12 D x 26 H in	1	1	Specify	\$626.95
6-1438288-670	Solid Door Wall Cabinet	30 W x 12 D x 30 H in	1	1	Specify	\$668.95
6-1438289-670	Solid Door Wall Cabinet	36 W x 12 D x 30 H in	1	1	Specify	\$862.95

**Sandusky Lee® Value Line Colors**



PLEASE SPECIFY COLOR CHOICE





**Acme Emergency Preparedness 3 Day Backpack**

**Be Prepared and Have a Plan!**

Perfect for sudden emergencies in workplace, home, school or vehicle. Emergency Backpack contains critical components needed when an emergency occurs including bad weather and power outages. Orange, lightweight backpack has padded shoulder straps and is perfectly sized to store additional items. A glow-in-the-dark tag makes it easy to find. Assembly of products is based on guidelines provided by FEMA and The American Red Cross.



Item #	Description	Quantity	List Price
9-2003330-670	3 Day Backpack	Each	\$148.89

**American Red Cross Personal Emergency Preparedness Kit**

Contains water, blanket, poncho, first aid and items to attract help. Packaged in a hands-free durable nylon backpack with extra room for personal items. Includes a complimentary brochure to help customize an emergency preparedness kit.



Item #	Description	Quantity	List Price
9-1392941-670	Red Cross First Aid Kit	Each	\$123.39

**School Health On The Go First Aid Kit**

This kit is perfect for quick response on campus or for field trips and other excursions. A 158 piece grab-and-go first aid kit includes first aid supplies for responding to medical emergencies during critical situations. Kit ideal for medical response in any emergency is packed in an over-the-shoulder clear-view ballistic nylon pouch.



Item #	Description	Quantity	List Price
9-1465126-670	First Aid Kit	Each	\$313.95

**Fabrication Enterprises Evacuation Medical Lift Stair Chair with Quick Release Buckles**

The Emergency Evacuation Standard 2 wheel stair chair, comes with a heavy duty orange vinyl protective cover that is durable and easy to clean. It features 3 heavy duty quick release restraint straps to secure individuals during transport or while moving the patient up or down stairs. This stair chair features 2 – 5" rear wheels that make for easy transport on most surfaces, as well as front and back handles for easier handling, the back 2 handles are used to support the chair while moving the patient, the back two handles are non-locking and used for upward lift. The front two handles on the evacuation stair chair, telescope out and lock into place to provide the best possible leverage when lifting the patient. The 3 safety straps should be used at all times while a patient is in the chair and it is recommended to always use the standard 2 wheel stair chair with 2 people for added safety. Weight capacity is 350 pounds.



Item #	Description	Quantity	List Price
9-2002189-670	Stair Chair	Each	\$772.95

**School Health Easy-Roll Backpack with LED Safety Signal**

Durable wheeled backpack with telescoping handle for easy transport of emergency supplies. Easily converts to a regular backpack as needed and includes flashing, high-visibility (up to 2,500 feet) LED signal for safety. LED safety signal works off 2 AA batteries (not included).



Item #	Description	Quantity	List Price
9-1396938-670	Easy Roll Backpack	Each	\$83.19

**School Health SecureEvac™ Easy-Roll Classroom Evacuation and Lockdown Kit**

A portable rolling emergency support kit for evacuating students and staff or supporting them in place during a lockdown for the first several hours after an emergency or disaster. Each kit includes survival supplies such as; First Aid Kit, Flashlight, Emergency Blankets, and Emergency drinking water pouches, radio with batteries, portable toilet, light sticks and an 8' x 10' tarp for up to 29 students and one teacher. High-visibility markings and flashing safety signal provide quick emergency identification and increased safety in use. This kit also supports fieldtrips and other off-campus events. Approved by the CDC.



Item #	Description	Quantity	List Price
9-1452574-670	Classroom Evac & Lockdown Kit	Each	\$818.95

**Evacusafe Excel Evacuation Chair**

The Excel Evacuation Chair is lightweight yet incredibly strong. The chair is suitable for people of varying size and weight (from children to adults), fully certified to a weight load of 500lbs. Specially designed tracks come into play on stairways, creating friction which acts as a brake to slow the descent and allow a smooth, controlled operation. Once ground level has been reached the handle folds away and the chair can be used as a temporary wheelchair. With a firm flat seat and armrests the evacuee can remain comfortable for long periods.



Item #	Description	Quantity	List Price
6-2095802-670	Evacuation Chair	Each	\$3,988.95

**School Health MobileAid® Hi-Vis Easy-Roll First Aid Stations**

These comprehensive First Aid Stations include 5 Quick Access first aid supply modules, flexible stretcher, 8 ft. first aid flag, and integrated seat & gear platform. The dual 4" polyurethane wheels have flashing (red/blue) LED lights, aid in rapid-response, and climb stairs and curbs with little effort. Platform allows for patient to be seated while being treated. Super durable, light weight frame construction supports up to 300 lbs. The Sports Station complies with the National Center for Sports Safety Standards. The Trauma Station includes 250 pieces and meets OSHA and ANSI standards. The All Terrain offers large "NeverFlat" foam-filled all-terrain tires for rough, outdoor terrain, or to make climbing or descending stairs easy



**Respond Immediately!  
Respond Effectively!  
Respond Confidently!**

Item #	Description	Quantity	List Price
9-1410383-670	Trauma Station	Each	\$1,173.95
9-1410384-670	Sports Station	Each	\$1,222.95
9-1586099-670	All Terrain Trauma Station	Each	\$1,714.95

**School Health First Aid/Field Trip Emergency Kit**

This First Aid Field Trip Emergency Kit contains all the essential supplies needed for a day away from school, all in a convenient fanny pack.



Item #	Description	Quantity	List Price
9-1400517-670	Field Trip Kit	Each	\$95.99





Products with a Mission®

QTY 1 C-A-T® Tourniquet	QTY 1 Responder 6 in. ETD	QTY 2 Responder Compressed Gauze	PAIR 2 Responder Nitrile Gloves, Lg
		QTY 1 Permanent Marker, Small	QTY 1 Responder Trauma Shears, Lg
INSTRUCTIONS FOR USE		SURVIVAL BLANKET	
QTY 1 Just in Time Instructions		QTY 1 Survival Blanket	

Contents of **BASIC** Individual Bleeding Control Kit

Every Second Counts!



Prepare Anyone for the Unexpected!



Public Access Bleeding Control 8 Pack, Vacuum Sealed

This pack is designed to provide bystanders and initial first responders with quick and easy access to essential medical equipment for stopping life-threatening bleeding. The pack includes 8 Individual Bleeding Control Kits contained in 1 easy to open carrying case. Also includes 1 Responder QuikLitter™ used to move the injured. Please visit [schoolspecialty.com](http://schoolspecialty.com) for individual kit details.

Item #	Description	Quantity	List Price
9-1546341-670	Kit - Basic	Each	\$1,118.95
9-1546342-670	Kit - Intermediate	Each	\$1,329.95
9-1546343-670	Kit - Advanced	Each	\$2,287.95

Individual Bleeding Control Kit with Carry Bag  
Control the Bleed with These Easy-To-Use Tools!

The Individual Bleeding Control Kit by North American Rescue is designed to provide essential equipment that empowers the general public to take action as immediate responders in stopping life threatening bleeding. Contained in a nylon carry bag, this life saving kit provides intuitive and easy to use tools that are proven to help save lives such as the fastest, safest, and most effective pre-hospital tourniquet in the world, the C-A-T® quality gauze, shears, and pressure dressings/bandages.

**Basic:** Provides life saving bleeding control equipment, such as tourniquets, pressure dressings, and gauze bandages, Shears, Powder free, Nitrile Responder Gloves (sz. Lg), and Survival Blanket.

**Intermediate:** Includes all equipment found in the Basic, plus the added capability to treat penetrating chest wounds with the HyFin® Vent Compact Chest Seal Twin Pack (for entrance and exit wounds).

**Advanced:** Includes all equipment found in the Intermediate, with added capability to treat major bleeding with Combat Gauze LE (hemostatic dressing that enhances blood clotting abilities for faster control) and HyFin® Vent Compact Chest Seal Twin Pack.

Item #	Description	Quantity	List Price
9-1581207-670	Kit - Basic	Each	\$160.95
9-1546332-670	Kit - Intermediate	Each	\$187.95
9-1546333-670	Kit - Advanced	Each	\$307.95

Individual & Mass Crisis Incident Kits

The Individual Aid Kit is designed for non-medically trained caregivers to control bleeding until medically trained responders arrive on the scene. Includes gauze, dressing, petroleum gauze, nitrile gloves, and surgical tape. The Mass Crisis Incident Kit is designed to store & transport Individual Aid Kits to classrooms, cafeterias, auditoriums, and other areas where a large mass of injured persons are gathered. The Mass Crisis Kit contains 40 Individual Compact Aid Kits packaged in a medium sized duffel style bag designed to be carried over the shoulder or hand carried on the scene.

Item #	Description	Quantity	List Price
9-1546355-670	Individual Compact Kit	Each	\$34.95
9-1546351-670	Mass Crisis Incident Kit	Each	\$1,651.95



Clear Polycarbonate Wall Stations  
Public Access Bleeding Control

Each station contains 1 Public Access Bleeding Control Pack, which includes 5 or 8 individual bleeding control kits in either vacuum-sealed pouches or red nylon bags with step-by-step pictorial instructions on how to use the provided medical equipment that is contained inside of an easy to open carrying case, 1 Responder QuikLitter™ used for moving the injured. Stored in a durable, clear polycarbonate cabinet that is easily accessible with highly visible "Stop the Bleed" placards for fast identification, all packed in a clear rugged storage case. Dimensions: 16" x 16" x 8". Please visit [schoolspecialty.com](http://schoolspecialty.com) for individual kit details.

Item #	Description	Quantity	List Price
<b>5-Pack, Vacuum Sealed</b>			
9-1585955-670	Kit - Basic	Each	\$1,162.95
9-1585956-670	Kit - Intermediate	Each	\$1,271.95
9-1585957-670	Kit - Advanced	Each	\$1,847.95
<b>8-Pack, Vacuum Sealed</b>			
9-1546344-670	Kit - Basic	Each	\$1,515.95
9-1546345-670	Kit - Intermediate	Each	\$1,706.95
9-1546346-670	Kit - Advanced	Each	\$2,520.95
<b>8-Pack, Nylon Bag</b>			
9-1546347-670	Kit - Basic	Each	\$1,719.95
9-1546348-670	Kit - Intermediate	Each	\$1,910.95
9-1546349-670	Kit - Advanced	Each	\$2,752.95

Download the App

**Preparing for the unexpected is simple with the Mobilize Rescue System!**

Sudden cardiac arrest represents 0.5% of the major emergencies that occur each year, which is why approximately 5 - 10 million AEDs have been installed worldwide. But what about the other 95.5% of medical emergencies? With an estimated 30,000 preventable traumatic deaths taking place each year, you need to be ready to manage traumatic injuries. The Mobilize Rescue System is the only interactive trauma and first aid system capable of helping untrained bystanders assess, manage, and monitor a spectrum of medical emergencies according to the protocols and best practices of the American Heart Association (AHA), Tactical Emergency Casualty Care (TECC), and the American College of Surgeons.

The Mobilize Rescue System includes instructions and supplies to manage severe bleeding, cardiac arrest, seizures, choking, chest trauma, hypothermia, burns, and more (around 80 medical emergencies) - all while the ambulance is en route.

The supplies in the Mobilize Rescue System are conveniently labeled and organized to match the instructions in the Mobilize Rescue app (each item is color-coded and numbered). The straightforward organization makes locating supplies easy, saving valuable time during an emergency. Mobilize will send out monthly email reminders for you to verify that your medical supplies are up to date and the technology is properly maintained (so that you can replace products that have expired and ensure you have properly charged your unit). We will also send an email to alert you when new app features become available, or medical protocol updates have been made to reflect the most current medical best practices.

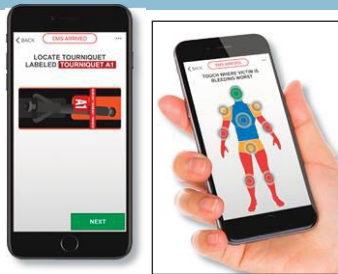

**Mobile Rescue Unit  
Convenient & Reliable  
New Trauma & Medical  
Emergency Technology!**

The Mobile unit is an easily transportable, interactive trauma and medical emergency response system that uses a diagnostic app to help untrained bystanders assess, manage, and monitor severe bleeding, cardiac arrest, chest trauma, seizures, overdoses, and more - all while the EMS is on the way. ANSI Class A kit



Item #	Description	Quantity	List Price
9-2000412-670	Mobile Rescue Unit	Each	\$3,985.95



**Wall Cabinets**

The Alarmed wall bracket is a threat prevention & safety notification system designed to mount the Comprehensive Unit alongside an AED, and to alert staff when the unit is removed from the bracket during a medical emergency.



Item #	Description	Quantity	List Price
9-2000411-670	Wall Cabinet Without Alarm	Each	\$322.95
9-2000416-670	Wall Cabinet With Alarm	Each	\$479.95
9-2009461-670	Alarmed Cabinet with Sign	Each	\$662.59

**School Health  
Mobilize  
Rescue Training Kit**

The Mobilize Rescue Training system integrates medical equipment and knowledge to allow any willing person to take meaningful action during the critical first minutes of an emergency. The Mobilize Rescue System Training when used with the training materials, will familiarize the people in your school with our systems so they can know what to expect during a crisis and gain an understanding of how and why the systems function as they do.



Item #	Description	Quantity	List Price
9-2019608-670	Trauma Trainer Kit	Each	\$374.95
9-2019602-670	Replenishment Kit	Each	\$289.95

**Mobilize Comprehensive  
Rescue System**

The Comprehensive unit is a wall-mountable, interactive trauma and medical emergency response system that uses a diagnostic app to help untrained bystanders assess, manage, and monitor severe bleeding, cardiac arrest, chest trauma, seizures, overdoses, and more - all while EMS is on the way. The color coded and numbered supplies match the app's instructions exactly! Water-resistant, durable case protects the life-saving supplies until they are needed. ANSI Class A kit.



Item #	Description	Quantity	List Price
9-2000415-670	Comprehensive Rescue System	Each	\$5,015.95



**Mobilize Rescue Public Access Station**

The Public Access Station empowers anyone to save lives with easily accessible bleeding control, trauma, & rescue-breathing equipment. Paired with a diagnostic app for immediate responders, each station includes a carrying case with 4 Individual Public Access Kits (I-PAKS) for distribution during a mass casualty event. Each iPAK (Individual Public Access Kit) contains a SOF-T Wide Tourniquet, 4 inch emergency trauma dressing, a QuikClot bleeding control dressing, hyfin chest seal, CPR Face shield with bite block, emergency space mylar blanket, 1 trauma shears, and 8 nitrile gloves.

Item #	Description	Quantity	List Price
9-2000417-670	Public Access Station	Each	\$1,548.95
9-2000420-670	Replacement Ipak	Each	\$349.95

**Mobilize Compact  
Rescue System**

The Compact unit is a travel-sized, interactive trauma and medical life-threats kit that pairs with an easily downloadable diagnostic app to help untrained bystanders assess, manage, and monitor severe bleeding, cardiac arrest, chest trauma, seizures, choking, and more - all while EMS is on the way.



Item #	Description	Quantity	List Price
9-2000419-670	Compact Rescue System	Each	\$393.95



**Hand Washing Reduces the Number of People Catching Colds by 45%!**

**Kutol Hand Sanitizers**

Instant Alcohol Free hand sanitizers kill a wide variety of microorganisms with the active ingredient Benzethonium Chloride. Alcohol Free sanitizers are foaming and non-flammable. Alcohol Sanitizer has 62% Ethyl Alcohol.



Item #	Description	Quantity	List Price
<b>Alcohol Free Foaming</b>			
9-1298173-670	50ml Personal Size	Case of 24	\$114.49
9-1298172-670	950ml Counter Top Size	Case of 8	\$173.89
9-2012752-670	950ml Counter Top Size	Each	\$21.69
<b>62% Alcohol Foaming</b>			
9-1329964-670	950ml Counter Top Size	Case of 8	\$203.09
9-1329965-670	1.7 oz Personal Size	Case of 24	\$138.99
<b>62% Alcohol Gel</b>			
9-1329967-670	950ml Counter Top Size	Case of 8	\$136.19
9-1329968-670	64 oz Pump	Case of 4	\$123.39

**Purell® ADX-12™ Dispenser & Sanitizers**

Purell ADX-12 Hand Sanitizer Dispenser is ideal for high-traffic areas. Large sight window skylight and clear refill bottles make it easy to check fill status. Fully ADA Compliant. Sanitizer is scientifically advanced, patent-pending formulation kills 99.99% of most common germs on hands. Meets EcoLogo hand sanitizer standard for environmental leadership and proven performance. Fragrance Free and dye free.



Item #	Description	Quantity	List Price
9-1568949-670	ADX-12 Dispenser	Pack of 6	\$48.59
9-1568950-670	Green Certified Foam	Pack of 3	\$198.79
9-1568951-670	Green Certified Gel	Pack of 3	\$105.39

**Purell® Pump Instant Hand Sanitizer**

Kills 99.9% of most common germs in as little as 15 seconds without water or towels. Specially formulated moisturizers leave hands feeling soft and refreshed even after repeated use. Dermatologist tested. Dye-free. A necessity for every classroom!



Item #	Description	Quantity	List Price
9-025507-670	Pump 8 oz Bottle	Each	\$5.19
9-1595289-670	2 Liter Pump Bottle	Case of 4	\$220.99



**Gojo® Natural Orange Hand Cleaner**

Quick-acting lotion formula for cleaning a broad range of industrial soils, medium dirt and grease. Orange citrus scent. Qualifies as a USDA BioPreferred product for Federal preferred procurement. 1/2 gallon each, 4 per case.

Item #	Description	Scent	Quantity	List Price
9-1389051-670	Hand Cleaner	Orange Citrus	Case of 4	\$125.49

**Dial Hand Soap & Sanitizer**

Strong and durable dispenser features the largest refill capacities from Dial Professional. Features heavy-duty ABS plastic construction. Innovative pump design provides thick, rich foam. Refills provide convenient and effective bacteria-kill. Kills 99.999% of pathogenic bacteria in as little as 15 seconds. Dermatologist-tested and hypoallergenic. Contains skin conditioners.



Item #	Description	Scent	Quantity	List Price
<b>Dispensers</b>				
9-2049989-670	Manual Soap Dispenser/Smoke	-	Each	\$5.49
9-2049985-670	Manual Soap Dispenser/Pearl	-	Each	\$4.99
<b>Refills</b>				
9-2049968-670	Antimicrobial Foam Hand Wash	SPRING WATER	Each	\$46.69
9-2050116-670	Hand Sanitizer Gel Refill	-	Each	\$44.39
9-2050117-670	Hand Sanitizer Foam Refill	-	Each	\$50.39
9-2050101-670	Antimicrobial Foam Hand Wash	Original	Each	\$44.39
9-2049995-670	Hypoallergenic Foam Hand Soap	Aloe	Each	\$57.59

**Purell® NXT® Space Saver™ Dispenser and Refills**

Push style dispensing and Compact wall design optimizes space. Durable ABS Plastic with rugged polycarbonate view windows. Mounts to wall with included adhesive tape or optional hardware. Multiple hole pattern allows use of existing wall holes. Kills 99.9% of most common germs in as little as 15 seconds without water or towels. Dermatologist tested. Dye-free.



Item #	Description	Quantity	List Price
9-1322720-670	Dispenser	Each	\$48.69
9-091174-670	1000mL Refill, Citrus Scent	Each	\$38.59



**The Master's® Artist's Hand Soap**

The Master's® hand soap leaves hands clean, soft, and fresh smelling. It washes grease, dirt, dyes, and ink from hands without drying them out. No need for harsh chemicals or paint thinners and won't pollute air or water. The kit includes the Kiss-Off® Stain Remover stick which removes dried paints & inks from fabric, cleans rubber stamps, and more. AP Approved. Made in the USA.



Item #	Description	Quantity	List Price
9-359261-670	Hand Soap	Each	\$7.69
9-2019943-670	Stain Remover & Soap Kit	Kit	\$12.39

Includes Kiss-Off Stain Remover and The Master's Hand Soap



### Lysol Dual Action Wipes

These dual action wipes have one side for scrubbing and one side for everyday touch-ups. The built-in scrubbing fibers scrub through tough messes. Each thick, pre-moistened wipe kills 99.9% of viruses and bacteria including the cold and flu viruses on hard nonporous surfaces when used as directed. Great for use in kitchens, bathrooms and playrooms.



Item #	Description	Quantity	List Price
9-2017129-670	75 Count Canister	Case of 6	\$96.89
9-2017126-670	35 Count Canister	Case of 12	\$117.29

### Clean Cut Disinfecting Wipes

#### Lemon Scent

CleanCut™ Disinfecting Wipes feature a dual-action formula that cleans up stubborn messes while it disinfects. Great for kitchens, bathrooms, offices, and classrooms, CleanCut™ Disinfecting Wipes kill 99.9 percent of bacteria in 15 seconds, including cold and flu viruses, staph, E. coli, salmonella, and strep. Each convenient wipe neutralizes odors on contact and has a long-lasting fresh scent to keep your space smelling clean. 35 wipes per pack



Item #	Description	Quantity	List Price
9-2087059-670	Disinfecting Wipes	Each	\$3.79

### Lysol® I.C. Disinfectants

Lysol I.C. Hospital Grade Foaming Disinfectant Cleaner can be used on fiberglass fixtures, glazed porcelain, synthetic marble, glazed tile, hard plastic and vinyl to help eliminate germs, toxins and viruses. This cleaner is designed to kill 99.9% of germs within 30 seconds. Lysol's disinfectant spray is ideal for hospitals, clinics, classrooms, home and office.



Item #	Description	Quantity	List Price
9-1595297-670	Foaming Cleaner	Case of 12	\$94.99
9-1595298-670	Disinfectant Spray	Case of 12	\$277.79

### Lysol® Disinfectant All Purpose Cleaner

Lysol® Professional All-Purpose Disinfectant Cleaners come in a trigger spray bottle and need no dilution. Convenient, ready-to-use, broad spectrum disinfectant and deodorizer kills 99.9% of germs in 30 seconds and cuts grease. Use on walls, painted woodwork, garbage cans, cabinets, floors, glazed tile, enamel and glazed porcelain. 32 oz.



Item #	Description	Quantity	List Price
9-1117224-670	All Purpose Cleaner	Each	\$12.59
9-1568933-670	Lemon Breeze	Pack of 12	\$132.79
9-1568934-670	All Purpose Cleaner	Pack of 12	\$133.29

### Lysol® Max Cover™ Disinfectant Mist

When it comes to disinfecting, you know you want a brand you can trust. But you also want to enjoy a better experience in the process. The new Brighter Tomorrow Series is specially crafted in uplifting fragrances in a stylized packaging to redefine the disinfecting experience of today's generation, but also provides the same kill claims as the tried and true, killing 99.9% of viruses, bacteria and fungi, including 8 cold & Flu viruses on hard surfaces and provides 2X wider coverage on big, soft surfaces without over wetting!

Item #	Description	Quantity	List Price
9-1595295-670	Brand New Day	Case of 6	\$130.39



### Spray Nine Multi Purpose Cleaner, Degreaser, & Disinfectant One Product with Nine Uses!

Cleans, degreases, disinfects against viruses in 30 seconds., disinfects against bacteria in 45 seconds, sanitizes in 10 seconds, kill fungus, deodorizes, controls mold and mildew and removes stains. Effective against H1N1, H1N3, MRSA, Influenza A virus, and other harmful germs. VOC compliant, no storage or handling restrictions. Ideal for facility maintenance use in break rooms, cafeterias, locker rooms, and more!



Item #	Description	Quantity	List Price
9-1449071-670	22 oz	Each	\$11.79
9-1449077-670	32 oz	Each	\$15.19
9-1449079-670	1 Gallon	Each	\$36.29

### Lysol® Disinfecting Wipes

Each thick, pre-moistened wipe kills 99.9% of viruses and bacteria on hard, nonporous surfaces and is effective against 46 microorganisms. Removes 95% of allergens. Ideal for cleaning, disinfecting, and deodorizing. Use on kitchen counters, appliances, stove tops, cabinets, floors, garbage cans, toilet exteriors, bathtubs, and sinks. EPA Registered.



Item #	Description	Scent	Quantity	List Price
9-2017128-670	35 Count Canister	Lemon & Lime Blossom	Case of 12	\$94.39
9-1557123-670	240 Count Wipes	Lemon and Lime Blossom	Case of 2	\$80.09
9-1334841-670	110 Count Canister	Lemon & Lime Blossom	Case of 6	\$114.39
9-1334842-670	80 Count Canister	Ocean Fresh	Case of 6	\$87.69
9-1595294-670	110 Count Canister	Ocean Fresh	Case of 6	\$114.19

### Professional® Lysol® Aerosol Spray

Hospital disinfectant/deodorant is highly effective against TB, MRSA and HIV-1 (AIDS virus). Tuberculocidal, virucidal, fungicidal, bactericidal. Prevents odors and growth of mold and mildew. Contains no CFCs. 19 oz. aerosol can.



Item #	Description	Quantity	List Price
9-091438-670	Original	Case of 12	\$239.99
9-091439-670	Fresh	Case of 12	\$224.49
9-091440-670	Crisp Linen	Case of 12	\$239.59
9-091441-670	Country	Case of 12	\$227.49
9-091442-670	Spring Waterfall	Case of 12	\$227.49

### Lysol® Clean & Fresh Multi Purpose Cleaners

Effectively cuts tough grease and grime. This multi-surface product cleans, disinfects, deodorizes, and kills 99.9% of viruses and bacteria including E. coli, Listeria, monocytogenes, salmonella, staphylococcus and other harmful germs on hard, nonporous surfaces. The economical, concentrated formula makes up to 64 gallons (1:64).



Item #	Description	Quantity	List Price
9-2001021-670	Lemon Breeze	Case of 4	\$87.79
9-2001022-670	Lavender Orchid	Case of 4	\$86.89



# outdoor & playground

**ultra site**  
A PLAYCORE Company

SEVEN YEAR  
**7**  
WARRANTY



Table with Benches



Square Table with Benches



Round Table with Benches



Utility Table

## UltraSite UltraCoat™ Thermoplastic Picnic Tables

Five layers of protection, including a thermoplastic powder coat finish (available in eight colors), provides nearly indestructible protection against the elements including rust and fade due to UV light and scratches. The smooth gloss finish is easy to maintain and the diamond pattern in the steel looks great. The table features a popular walk-through design and has a black base. Other options are available, please contact your School Specialty Representative.

Item #	Description	Top Size	Top Color	Frame Color	Product Dimensions	Pattern Type	Base/Mount Type	Material	List Price
6-078910-670	Table with Benches	72 W x 30 <sup>-5/16</sup> D in	Specify	Specify	72 W x 64 <sup>-3/4</sup> D x 30 <sup>-5/16</sup> H in	Diamond	Portable	Expanded Metal, Polyethylene	\$2,412.95
6-078909-670	Table with Benches	96 W x 30 <sup>-5/16</sup> D in	Specify	Specify	96 W x 64 <sup>-3/4</sup> D x 30 <sup>-5/16</sup> H in	Diamond	Portable	Expanded Metal, Polyethylene	\$2,593.95
6-1399757-670	Square Table w/ Benches	46 W x 46 D in	Specify	Specify	78 <sup>-3/4</sup> W x 78 <sup>-3/4</sup> D x 30 <sup>-1/4</sup> H in	Diamond	Surface / Portable Mount	Expanded Metal, Polyethylene	\$2,188.95
6-1399756-670	Round Table w/ Benches	46 dia in	Specify	Specify	83 <sup>-3/16</sup> W x 83 <sup>-3/16</sup> D x 30 <sup>-1/8</sup> H in	Diamond	Surface / Portable Mount	Expanded Metal, Polyethylene	\$2,678.95
6-1443571-670	Utility Table	72 W x 30 D in	Specify	Specify	72 W X 30 D x 28 <sup>-15/16</sup> H in	Diamond	Portable	Expanded Metal, Polyethylene	\$1,573.95
6-1443575-670	Utility Table	96 W x 30 D in	Specify	Specify	96 W x 30 D x 28 <sup>-15/16</sup> H in	Diamond	Portable	Expanded Metal, Polyethylene	\$1,736.95

PLEASE SPECIFY COLOR CHOICE

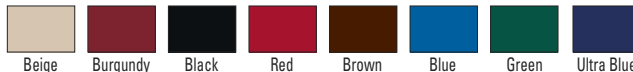

### UltraCoat™ Colors





**UltraSite® Pre-School Portable Learning Table**

The portable preschool table comes in a 20" high and 46" square table top with rounded corners.

Comes with the full alphabet and numbers 0-9 to compliment your early childhood setting. 1-5/8" O.D. all MIG welded pipe with 1" O.D. brace with walk through design. All stainless steel hardware. Seat height is 12".

Item #	Description	Top Size	Product Dimensions	List Price
6-1364780-670	Square Learning Table	46 W x 46 D in	78-11/16Wx78-11/16Dx20-3/16Hin	\$3,635.95

**UltraSite UltraCoat™ Thermoplastic Bench**

Available in 6' and 8' lengths, this extra heavy-duty bench features UltraCoat™, a premium thermoplastic coating by UltraPlay with superior adhesion that creates a seal tight bond to the metal surface and ensures a smooth, shiny finish. Available in eight colors. Benches can be inground or surface mounted. Other options are available, please contact your Territory Representative.

Item #	Description	Product Dimensions	Color	Base/Mount Type	Pattern Type	List Price
6-078911-670	Bench with Back	72 L x 22-1/4 D x 35 H in	Specify	Specify	Diamond	\$1,389.95
6-1399758-670	Bench with Back	96 L x 22-1/4 D x 35 H in	Specify	Specify	Diamond	\$1,482.95



Shown with Flat-Top Lid, Lids and Liners sold separately



Shown with Round-Top Lid, Lids and Liners sold separately

**UltraSite® Thermoplastic Trash Receptacle**

Diamond-patterned 32 gallon trash receptacle (available in eight colors). Choose either the flat-top lid in 18-gauge spun metal, or the round-top lid with swing door in heavy-duty polyethylene. Lids and liners sold separately.

Item #	Description	Color	Product Dimensions	List Price
6-078912-670	Trash Can	Specify	23-1/4 Dia x 29-3/4 H in	\$819.95
6-078914-670	Can Liner	Black	21-7/8 Dia x 27-1/2 H in	\$148.95
6-078913-670	Round-top Lid	Black	24-7/8 Dia x 11-3/4 H in	\$356.95
6-5003906-670	Flat Top Lid	Specify	24 W in	\$356.95

**UltraCoat™ Colors**

PLEASE SPECIFY COLOR CHOICE

		Beige	Burgundy	Black	Red	Brown	Blue	Green	Ultra Blue





**UltraSite® Lexington Benches**

The Lexington Bench is available in 4' and 6' lengths. It features a cast aluminum frame with the UltraCoat™ thermoplastic finish. These benches are both portable and/or surface mounted.

Item #	Product Dimensions	Color	Base/Mount Type	Pattern Type	List Price
<b>With Back</b>					
6-1443508-670	51 L x 27 D x 35-1/2 H in	Specify	Surface / Portable Mount	Diamond	\$2,232.95
6-1443509-670	51 L x 27 D x 35-1/2 H in	Specify	Surface / Portable Mount	Perforated	\$2,485.95
6-1443510-670	51 L x 27 D x 35-1/2 H in	Specify	Surface / Portable Mount	Fiesta	\$2,485.95
6-1443511-670	51 L x 27 D x 35-1/2 H in	Specify	Surface / Portable Mount	Wave	\$2,485.95
6-1443512-670	51 L x 27 D x 35-1/2 H in	Specify	Surface / Portable Mount	Slat	\$2,485.95
6-1443513-670	75 L x 27 D x 35-1/2 H in	Specify	Surface / Portable Mount	Diamond	\$2,290.95
6-1443514-670	75 L x 27 D x 35-1/2 H in	Specify	Surface / Portable Mount	Perforated	\$2,570.95
6-1443515-670	75 L x 27 D x 35-1/2 H in	Specify	Surface / Portable Mount	Fiesta	\$3,020.95
6-1443516-670	75 L x 27 D x 35-1/2 H in	Specify	Surface / Portable Mount	Wave	\$3,020.95
6-1443517-670	75 L x 27 D x 35-1/2 H in	Specify	Surface / Portable Mount	Slat	\$3,020.95
<b>W/Out Back</b>					
6-1443518-670	51 L x 30-1/4 D x 25 H in	Specify	Surface / Portable Mount	Diamond	\$2,011.95
6-1443519-670	51 L x 30-1/4 D x 25 H in	Specify	Surface / Portable Mount	Perforated	\$2,264.95
6-1443520-670	51 L x 30-1/4 D x 25 H in	Specify	Surface / Portable Mount	Fiesta	\$2,264.95
6-1443521-670	51 L x 30-1/4 D x 25 H in	Specify	Surface / Portable Mount	Wave	\$2,264.95
6-1443522-670	51 L x 30-1/4 D x 25 H in	Specify	Surface / Portable Mount	Slat	\$2,264.95
6-1443523-670	75 L x 30 D x 25 H in	Specify	Surface / Portable Mount	Diamond	\$2,072.95
6-1443524-670	75 L x 30 D x 25 H in	Specify	Surface / Portable Mount	Perforated	\$2,346.95
6-1443526-670	75 L x 30 D x 25 H in	Specify	Surface / Portable Mount	Fiesta	\$2,808.95
6-1443527-670	75 L x 30 D x 25 H in	Specify	Surface / Portable Mount	Wave	\$2,808.95
6-1443528-670	75 L x 30 D x 25 H in	Specify	Surface / Portable Mount	Slat	\$2,808.95
<b>Lexington Trash Receptacle</b>					
6-1443529-670	31-1/2 Dia x 37-3/4 H in	Specify	-	-	\$2,849.95



Lexington Bench W/Out Back

Custom options are available. Please contact your School Specialty Rep.



Lexington Bench With Back



Contour Bench With Back

**UltraSite® Contour Series Benches**

The Contour Bench is available in 4' and 6' lengths. It features a powder coat frame with the UltraCoat™ thermoplastic seat. These benches are portable, inground and/or surface mounted. Please visit schoolspecialty.com for benches without backs.

Item #	Product Dimensions	Color	Base/Mount Type	Pattern Type	List Price
<b>With Back</b>					
6-1443551-670	48 W x 31 D x 48 H in	Specify	Specify	Diamond	\$1,887.95
6-1443552-670	48 W x 31 D x 48 H in	Specify	Specify	Perforated	\$2,177.95
6-1443554-670	48 W x 31 D x 48 H in	Specify	Specify	Wave	\$2,177.95
6-1443555-670	48 W x 31 D x 48 H in	Specify	Specify	Slat	\$2,177.95
6-1443553-670	48 W x 31 D x 48 H in	Specify	Specify	Fiesta	\$2,301.95
6-1443556-670	72 W x 31 D x 48 H in	Specify	Specify	Diamond	\$2,363.95
6-1443557-670	72 W x 31 D x 48 H in	Specify	Specify	Perforated	\$2,777.95
6-1443559-670	72 W x 31 D x 48 H in	Specify	Specify	Wave	\$2,777.95
6-1443560-670	72 W x 31 D x 48 H in	Specify	Specify	Slat	\$2,777.95
6-1443558-670	72 W x 31 D x 48 H in	Specify	Specify	Fiesta	\$2,871.95

**UltraSite® Charleston Bench with Back**

The Charleston Bench is available in 4' and 6' lengths. It features a cast aluminum frame with the UltraCoat™ thermoplastic finish. These benches are portable or surface mounted.

Item #	Description	Product Dimensions	Color	Base/Mount Type	Material	Pattern Type	List Price
6-1443498-670	Bench with Back	52 W x 23 D x 35 H in	Specify	Surface / Portable Mount	Steel	Diamond	\$2,585.95
6-1443500-670	Bench with Back	52 W x 23 D x 35 H in	Specify	Surface / Portable Mount	Steel	Fiesta	\$2,776.95
6-1443501-670	Bench with Back	52 W x 23 D x 35 H in	Specify	Surface / Portable Mount	Steel	Wave	\$2,776.95
6-1443502-670	Bench with Back	52 W x 23 D x 35 H in	Specify	Surface / Portable Mount	Steel	Slat	\$2,776.95
6-1443499-670	Bench with Back	52 W x 23 D x 35 H in	Specify	Surface / Portable Mount	Steel	Perforated	\$2,841.95
6-1443503-670	Bench with Back	76 W x 23 D x 35 H in	Specify	Surface / Portable Mount	Steel	Diamond	\$2,652.95
6-1443504-670	Bench with Back	76 W x 23 D x 35 H in	Specify	Surface / Portable Mount	Steel	Perforated	\$2,932.95
6-1443505-670	Bench with Back	76 W x 23 D x 35 H in	Specify	Surface / Portable Mount	Steel	Fiesta	\$3,385.95
6-1443506-670	Bench with Back	76 W x 23 D x 35 H in	Specify	Surface / Portable Mount	Steel	Wave	\$3,385.95
6-1443507-670	Bench with Back	76 W x 23 D x 35 H in	Specify	Surface / Portable Mount	Steel	Slat	\$3,385.95



Charleston Bench with Back

**UltraSite Thermoplastic Finish Colors**

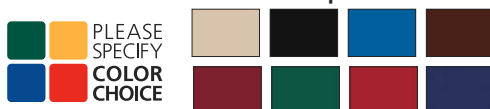

**UltraSite Bench/Chair Patterns**

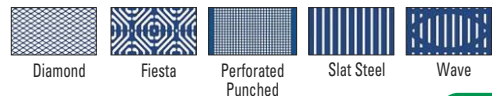

NEW



**Frog Furnishings Hexagon Recycled Picnic Table**

The Hexagon Recycled Plastic Picnic Table from Frog Furnishings has a bold design that accommodates large groups of people. The resinwood planks and frame are made entirely from recycled plastic, so they won't chip or splinter like wood, won't fade in the sun or rot in soggy conditions. Includes a center hole for an umbrella. Portable and/or surface mount. Available in 4 plank colors: Cedar, Green, Gray and Brown.



Item #	Description	Top Color	Frame Color	Product Dimensions	Base/Mount Type	List Price
6-5009857-670	Recycled Picnic Table	Specify	Black	75-1/2W x 75-1/2D x 28-3/4H in	Surface / Portable Mount	\$1,824.95

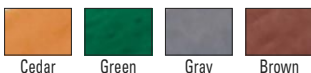

**UltraSite® Heavy Duty Rectangular Picnic Tables**

Features an all MIG welded 1 5/8" O.D. walk through portable frame with 1 1/16" O.D. brace. Choose from Redwood Stained or Pressure Treated Wood. Other table options such as ADA available. Contact your School Specialty Account Manager.

Item #	Description	Product Dimensions	Color	Top Shape	Material Type	List Price
6-471231-670	6 Foot Table	72 W x 60 D x 30 H in	Redwood Stain	Rectangle	Wood	\$1,091.95
6-471232-670	8 Foot Table	95 W x 60 D x 30 H in	Redwood Stain	Rectangle	Wood	\$1,298.95
6-1364746-670	6 Foot Table	72 W x 60 D x 30 H in	Brown	Rectangle	Pressure Treated Wood	\$1,081.95
6-1364747-670	8 Foot Table	95 W x 60 D x 30 H in	Brown	Rectangle	Pressure Treated Wood	\$1,139.95



**UltraSite® Heavy Duty Square Picnic Tables**

Features a rugged bolt-through design with a 1 5/8" O.D. portable walk through frame and a 1 1/16" O.D. brace. Choose from Redwood Stained, Pressure Treated or Recycled Plastic. Other colors and options such as ADA models available. Contact your School Specialty Account Manager.



Pressure Treated Wood

Item #	Description	Product Dimensions	Color	Top Shape	Material Type	List Price
6-1364742-670	4 Foot Square Table	74-1/2 W x 74-1/2 D x 30 H in	Brown	Square	Pressure Treated Wood	\$1,436.95
6-1364743-670	4 Foot Square Table	74-1/2 W x 74-1/2 D x 30 H in	Redwood Stain	Square	Wood	\$1,478.95
6-1466781-670	4 Foot Square Table	74-9/16Wx74-9/16Dx29-15/16H in	Specify	Square	Recycled Plastic	\$3,793.95



**UltraSite® Charleston Recycled Bench with Back**

The Charleston Bench is available in 6' and 8' lengths. Recycled planks with thermoplastic finish on the frame. These benches are portable or surface mounted.

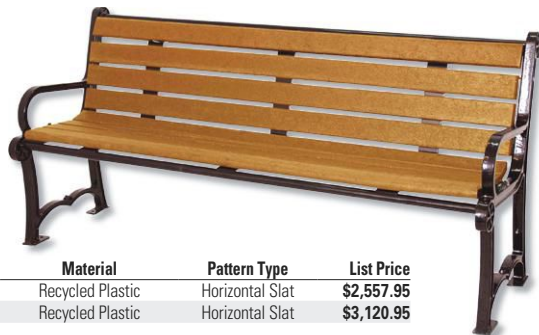

Item #	Description	Product Dimensions	Color	Base/Mount Type	Material	Pattern Type	List Price
6-1443530-670	Bench with Back	76 W x 26-3/4 D x 35-3/4 H in	Specify	Specify	Recycled Plastic	Horizontal Slat	\$2,557.95
6-1443531-670	Bench with Back	99-1/2 Wx26-3/4 Dx35-3/4 H in	Specify	Specify	Recycled Plastic	Horizontal Slat	\$3,120.95



**UltraSite Wood Colors**



**UltraSite Recycled Bench Colors**



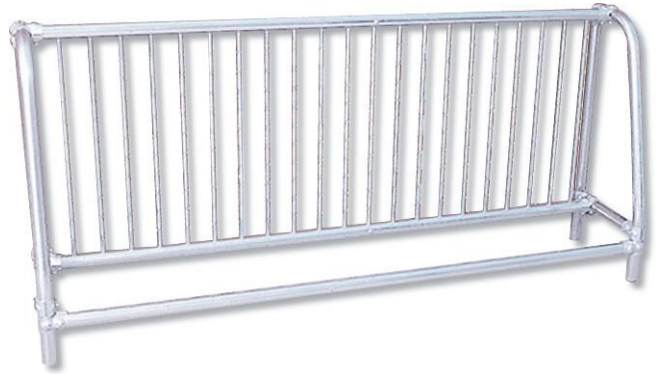

**UltraSite® Traditional Bicycle Racks**

Double-sided bike racks have rungs spaced in groups to facilitate uniform parking and allow easier entrance and exit of bicycles. Constructed of 1 5/8" O.D. galvanized iron pipe with spacers of 5/8" O.D. galvanized 16-gauge tubing, joined together by heavy-gauge stamping, all of which are galvanized for maximum corrosion resistance. Racks are available as in-ground, surface mount and portable and feature add-on capability to create longer racks to meet growing needs.

Item #	Product Length	Capacity	Color	Starter/Adder	List Price
6-471228-670	5 ft	10 Bikes	Silver	Adder	\$954.95
6-631728-670	5 ft	10 Bikes	Silver	Starter	\$1,005.95
6-471229-670	8 ft	16 Bikes	Silver	Adder	\$1,228.95
6-631734-670	8 ft	16 Bikes	Silver	Starter	\$1,605.95
6-471230-670	10 ft	20 Bikes	Silver	Adder	\$1,501.95
6-631740-670	10 ft	20 Bikes	Silver	Starter	\$1,843.95

**UltraSite® Single Sided Bicycle Racks**

Single sided bike rack is constructed using 1 5/8" O.D. steel pipe with spacers of 5/8" O.D. steel tubing, joined together by heavy gauge stamping, all of which are galvanized for maximum corrosion resistance. Racks are portable and feature add-on capability for growing needs.

Item #	Product Length	Capacity	Starter/Adder	List Price
6-1364676-670	5 ft	5 Bikes	Adder	\$846.95
6-1364784-670	5 ft	5 Bikes	Starter	\$924.95
6-1364678-670	8 ft	8 Bikes	Adder	\$989.95
6-1364677-670	8 ft	8 Bikes	Starter	\$1,099.95
6-1364680-670	10 ft	10 Bikes	Adder	\$1,150.95
6-1364679-670	10 ft	10 Bikes	Starter	\$1,246.95



**UltraSite® Bike Racks**

Bike Racks each park two bikes and are available in black powder coat or galvanized finishes. All racks are U-lock compatible. Racks are available in surface or in-ground mount options. For other mounting and color options, please contact your School Specialty Rep.

Item #	Description	Color	Base/Mount Type	List Price
6-2027685-670	Inverted U Bike Rack	Black	Surface Mount	\$365.95
6-2027692-670	Inverted U Bike Rack	Galvanized	Surface Mount	\$365.95
6-2027689-670	Ring and Post Bike Rack	Black	Surface Mount	\$443.95
6-2027686-670	Ring and Post Bike Rack	Galvanized	Surface Mount	\$443.95

**UltraSite® Contemporary Loop Bike Racks**

The Contemporary Loop Bike Rack is all one piece with no assembly required. Available as inground or surface mount. Available in either galvanized or powder-coated color options.

Item #	Description	Product Length	Capacity	Color	Base/Mount Type	List Price
6-1443601-670	1 Loop	14-3/8 in	2 Bikes	Specify	Specify	\$503.95
6-1443602-670	3 Loop	39 in	5 Bikes	Specify	Specify	\$1,069.95
6-1443603-670	5 Loop	63 in	7 Bikes	Specify	Specify	\$1,288.95
6-1443604-670	7 Loop	87-1/2 in	9 Bikes	Specify	Specify	\$1,456.95
6-1443606-670	9 Loop	112 in	11 Bikes	Specify	Specify	\$1,826.95
6-1443607-670	11 Loop	136-1/4 in	13 Bikes	Specify	Specify	\$2,215.95



**UltraSite Loop Bike Rack Colors**

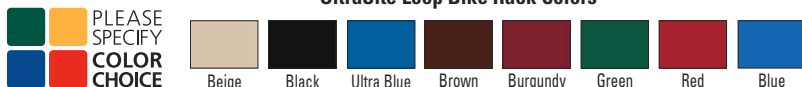





**NRS with Guardrail**

These industrial grade, high quality aluminum structures include a center aisle, guardrail and double facing foot planking so navigating is safe and easy. Includes a chain link guardrail system.

Item #	Description	Product Length	Number of Rows	List Price
6-2027762-670	Fixed Bleachers	15 ft	4	\$10,811.95
6-2027761-670	Fixed Bleachers	21 ft	4	\$13,533.95
6-2027760-670	Fixed Bleachers	15 ft	5	\$14,298.95
6-2027759-670	Fixed Bleachers	21 ft	5	\$16,462.95

**NRS Low Rise Aluminum Bleachers**

Low rise bleachers are ideal for those areas and occasions where you need more seating capacity. The low rise feature meets most seating codes. Wood sleepers are standard. Contact your School Specialty Representative for other sizes and seating configurations.



Item #	Description	Product Length	Number of Rows	List Price
6-1372804-670	Low Rise Bleacher	9 ft	4	\$3,179.95
6-1372805-670	Low Rise Bleacher	15 ft	4	\$4,966.95
6-1372806-670	Low Rise Bleacher	21 ft	4	\$6,767.95
6-1372807-670	Low Rise Bleacher	27 ft	4	\$9,190.95



**NRS Tip-N-Roll Bleachers**

These bleachers are ideal for areas and occasions where permanent seating is not feasible. Available in aluminum frame with aluminum seating. Includes permanently mounted 5" casters and hard rubber feet to prevent scuffing or marking of floors. 2, 3 and 4 row models available.

Item #	Description	Product Length	Number of Rows	List Price
6-1364768-670	Tip-N-Roll Bleacher	9 ft	2	\$1,657.95
6-1364771-670	Tip-N-Roll Bleacher	9 ft	3	\$2,189.95
6-1372808-670	Tip-N-Roll Bleacher	9 ft	4	\$3,631.95
6-1303050-670	Tip-N-Roll Bleacher	15 ft	2	\$2,834.95
6-1364772-670	Tip-N-Roll Bleacher	15 ft	3	\$3,389.95
6-1372809-670	Tip-N-Roll Bleacher	15 ft	4	\$5,341.95
6-1364770-670	Tip-N-Roll Bleacher	21 ft	2	\$3,218.95
6-1364773-670	Tip-N-Roll Bleacher	21 ft	3	\$4,516.95
6-1372810-670	Tip-N-Roll Bleacher	21 ft	4	\$7,229.95

### Bison® Playtime Standard™ Playground System

The Bison Playtime Standard Playground System has a steel base with a white powder-coated, heavy, tubular steel frame and built-in non-marring wheels. The playground system is adjustable in 6" increments from 6 1/2" to the overall 8' height. The official sized 5/8" steel rim is mounted on a 3' x 4' molded graphic backboard. The standard playground system is not designed for aggressive competitive play, but for more controlled after-school physical education classes or shooting practice. Kid-safe padding is included.

Item #	Description	Backboard Size	List Price
6-015226-670	Bison Playtime Standard	48 W x 36 H in	\$3,260.95



### Bison® QwikChange™ Portable Playground System

Bison QwikChange Portable Playground System has popular playground features at a popular price. Heavy galvanized 3 1/2" steel pole. 36" x 48" molded graphite backboard and flex goal adjusts from 7 1/2' to 10' in 6" increments. QwikChange design requires only a pole to change height from the ground. One year limited warranty. Factory installed 350 lbs of ballast. Built-in transport wheels.

Item #	Description	Backboard Size	List Price
6-1326503-670	Quickchange Portable System	48 W x 36 H in	\$4,722.95



### Bison® Heavy Duty 4 1/2" Playground System

Bison's Heavy Duty 4 1/2" O.D. pole provides a 48" safe play area and features a direct goal mount design that improves backboard durability. With heavy duty 1 5/8" backboard support braces and a 48" ground bury, it provides stability even in deep frost regions. Zinc-plated pole and hardware and 5" x 5" goal mounting pattern. 25 year limited warranty. Heavy Duty packages have a variety of backboard and goal options to meet all of your needs. Add optional pole padding for increased player safety.

Item #	Description	Backboard Size	Color	List Price
6-013500-670	Aluminum Fan System	54 W x 35-1/2 H in	White	\$3,429.95
6-1293208-670	Heavy Duty Steel Fan Playground	54 W x 39 H in	White	\$4,412.95
6-1393542-670	Rectangular Steel System	60 W x 42 H in	White	\$5,138.95
6-1393543-670	Rect. Polycarbonate System	54 W x 42 H in	Clear	\$7,109.95
6-1393527-670	Wrap-Around Padding	-	Black	\$633.95
6-1393513-670	Fitted Padding	-	-	\$1,213.39



### Bison® Tough Duty 3 1/2" Playground System

Bison's Tough Duty 3 1/2" O.D. pole provides a 36" safe play area. 36" ground bury. Direct goal mount design. Heavy-duty 1 5/8" diameter braces to support backboard are included. Zinc-plated pole and hardware. 5" x 5" goal mounting pattern. Add optional pole padding for increased player safety. 10 year limited warranty on pole.

Item #	Description	Backboard Size	List Price
6-1288440-670	Aluminum Fan System	54 W x 35-1/2 H in	\$1,968.95
6-1393541-670	Rectangular Steel Backboard	54 W x 39 H in	\$3,199.95
6-1393540-670	Steel Fan System	54 W x 39 H in	\$3,397.95
6-1393527-670	Wrap-Around Padding	-	\$633.95
6-1393513-670	Fitted Padding	-	\$1,213.39



### Bison® Mega Duty 5 9/16" Playground System

Bison's Mega Duty 5 9/16" O.D. pole provides a 72" safe play area. Goal mounts directly through backboard to pole, virtually eliminating stress on backboard when hanging occurs. Heavy, 1 5/8" backboard braces and 48" in-ground bury make it one structurally sound system. The Mega Duty packages have a variety of backboard and goal options to meet all of your needs. Add additional pole padding for increased player safety.

Item #	Description	Backboard Size	Color	List Price
6-1393536-670	Aluminum Fan-shaped System	54 W x 35-1/2 H in	White	\$5,625.95
6-1393537-670	Steel Fan-shaped System	54 W x 39 H in	White	\$6,340.95
6-1393544-670	Steel Rectangular System	60 W x 42 H in	White	\$6,935.95
6-1393546-670	Perforated Steel Rectangular	72 W x 42 H in	White	\$8,248.95
6-1393545-670	Polycarbonate Rectangular	54 W x 42 H in	Clear	\$9,049.95
6-1393527-670	Wrap-Around Padding	-	Black	\$633.95
6-1393513-670	Fitted Padding	-	-	\$1,213.39







**Basketball Nets**

Always have replacement nets on hand.

- Available in heavy-duty nylon, no whip net or steel chain
- Nylon, cotton and standard chain nets are for use with "no-tie" rims
- Chain net attaches via supplied "S" hooks to any goals

Item #	Description	Brand	Color	Quantity	List Price
A 9-009520-670	Heavy Duty	Champion	White	Pack of 2	\$7.99
B 6-008858-670	No Whip Net	Sportime	White	Pair of 2	\$712.95
C 9-012689-670	Chain Net	Bison	Silver	Each	\$123.49



**SPORTIME DropHoops**

Raise Shooting Success

- Made with lightweight yet rugged polymer tubing
- Drophoop suspends 26" below the existing hoop, unimpeding shooting
- Drophoop measures 22" in diameter goal and is 7' 10" in height
- Fast installation with no tools required
- Latex free

Item #	Color	Quantity	List Price
9-022954-670	Black	Each	\$116.19



**SPORTIME Hang-A-Hoops**

Hang Wherever You Want, And Wherever Your Students Need

Sportime® Hang-A-Hoops allows suspension at whatever height to bring success

- Come in 2 sizes - regulation size 18" and Big Mouth 22"
- Can virtually be attached to anything with included clip (a fence, an eye-bolt on the wall)
- Made of high quality PVC to be structurally sound
- This product can expose you to chemicals including Diisononyl phthalate (DINP) which is known in the state of California to cause cancer

Item #	Description	Color	Quantity	List Price
9-005257-670	Regulation Hang-A-Hoop	Black	Each	\$130.49
9-014944-670	Big-mouth Hang-A-Hoop	Black	Each	\$97.89



**SPORTIME Hang-A-Hoop Backboards**

Increase The Versatility Of Your Existing Hang-A-Hoops™

- Measures 22" x 31"
- Made from durable melamine MDF construction
- Painted shooter's square measures 10" x 16"

Item #	Description	Color	Quantity	List Price
9-022276-670	Backboard Only	White/Orange	Each	\$110.09





**SPORTIME TierDrop Goal**

**Children Find Their Own Levels Of Success**

Sportime® Tierdrop Two Hoop Basketball Goal triples the opportunities for players to score

- Two 18" diameter hoops cascade down from regulation size goal each a foot lower for easier shooting success
- Attaches with hook-and-loop straps
- A ladder may be needed for installation

Item #	Color	Quantity	List Price
9-019792-670	Multi-Color	Each	\$128.19



**Pull-Buoy CircleShoot Starter Hoop**

Pull-Buoy CircleShoot Starter Hoop presents the first starter hoop unit with no screws, nuts, or bolts needed for assembly

- High-impact 1" plastic posts will not kink
- Base has a 36" diameter and regulation 18" rim and sits 3-1/2' high
- Use with foam, plastic or light weight balls
- Snap together with C-clips

Item #	Color	Quantity	List Price
9-1592903-670	Blue	Each	\$168.29



**Jaypro Basketball Adapters**

**Jaypro Easy Play Adapters and Uprights**

- Goal adapter fits any 2" game standard upright
- Backboard adapter features a 7' max goal height
- Adapters come with mounting hardware
- Standard game upright features 6-5/8" O.D. steel with an offset to maximize stability
- Upright has 2 piece shaft with sliding collars for adjusting net height, measures 40" x 32" x 10'



Item #	Description	Brand	Color	Quantity	List Price
9-2020796-670	Net Ball Adapter	Jaypro	Orange	Each	\$331.29
9-2020797-670	Basketball Adapter	Jaypro	-	Each	\$893.39
9-015260-670	Easy Play Game Standard	Jaypro	Blue	Each	\$540.99



**Children's Factory® 4-Rings Basketball**

Childrens Factory 4-Ring Basketball helps develop hand-eye coordination

- Basketball stand is made of a powder coated metal
- Base is 36" in diameter, hoops are 18" in diameter
- Hoops are collapsible
- Replacement nets are made of nylon and colored Red, White and Blue
- Mini basketball is 11" in diameter and features a rubber shell

Item #	Description	Brand	Color	Quantity	List Price
9-2002200-670	Basketball Stand 4- Rings	Childrens Factory	Blue	Each	\$378.19
9-2004055-670	Basketball Nets	Childrens Factory	White/Red	Set of 4	\$39.99
9-1599274-670	Mini Basketball	Sportime	Orange	Each	\$21.49

# playground equipment: turnkey package

## package includes

- engineered wood fiber
- border timbers
- ADA ramp
- installation
- freight

Taxes not included

Pictured above is the Top View of Hamlet. To the right, it is shown in the "Playful" colors.



## Hamlet Play Structure

Hamlet turnkey package provides a one stop solution for customers who are looking for an easy process to purchasing a complete playground. The package includes the Hamlet playground, safety surfacing, border timbers, standard installation, and freight. Ages: 2-5 or 5-12. Includes 12 activities. Use Zone: 26'6" x 31'. Available in Recycled Metal & Plastic or Conditioned Wood. Playhouse atmosphere of the Hamlet features play counters, rock climbing wall, suspended bridge, xylophone, duo chute slide and many other activities.

Item #	Description	Age Range	Capacity	Base Core Color	List Price
6-2105171-670	Hamlet Play Structure -Playful	2-5 Years or 5-12 Years	15-20 Children	Playful	\$146,499.95
6-2104933-670	Hamlet Play Structure -Natural	2-5 Years or 5-12 Years	15-20 Children	Natural	\$146,499.95

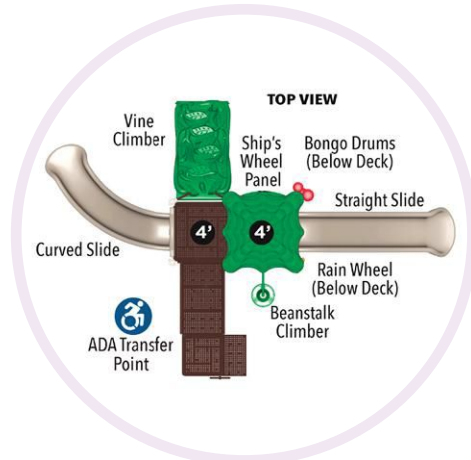

Pictured above is the Top View of Hawk's Nest.



Pictured: border timbers & engineered wood fiber (surfacing option).



Pictured is Hawk's Nest in the "Natural" Colors

## Hawk's Nest Play Structure

Hawk's Nest turnkey package provides a one stop solution for customers who are looking for an easy process to purchasing a complete playground. The package includes the Hamlet playground, safety surfacing, border timbers, standard installation, and freight. Ages: 2-5 or 5-12. Includes 12 activities. Use Zone: 34'1" x 26'4". Available in Recycled Metal & Plastic or Conditioned Wood. Playhouse atmosphere of the Hawk's Nest features beanstalk climber, curved slide, vine climber, bongo drums and many other activities.

Item #	Description	Age Range	Capacity	Use Zone	Base Core Color	List Price
6-2105170-670	Hawk's Nest - Natural	2-5 Years or 5-12 Years	15-20 Children	34 ft-1 in x 26 ft-4 in	Natural	\$58,499.95
6-2105172-670	Hawk's Nest - Playful	2-5 Years or 5-12 Years	15-20 Children	34 ft-1 in x 26 ft-4 in	Playful	\$58,499.95





**NEW**

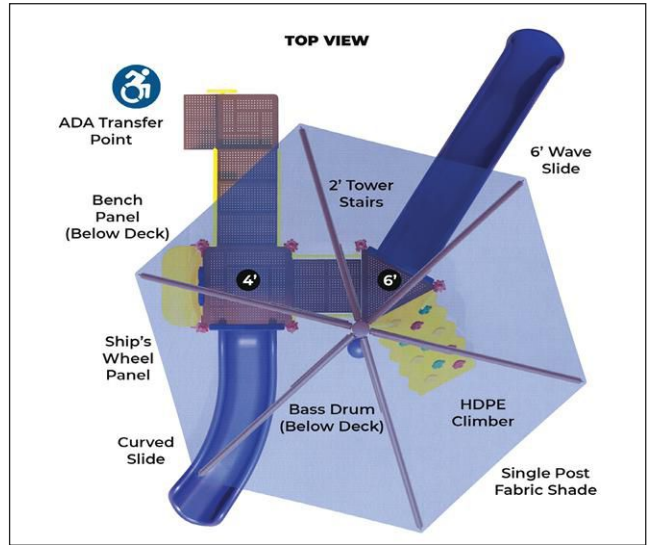

**Ultra Play® Timber Glen Play Structure**

The Timber Glen features two slides at different heights to give children different sliding experiences. The Deluxe Rock Climber combines both upper and lower body strength. When children need a break, they can hang out on the Bench Panel or make music with the Bass Drum. The 20 ft. x 20 ft. integrated fabric shade must be installed in ground only. Includes 6 activities. Color options playful or natural. Ground spike kit included (Anchor Bolt and Inground Kit sold separately).

Item #	Description	Product Dimensions	Age Range	Capacity	Use Zone	Base Core Color	List Price
6-2104586-670	Timber Glen, With Shade	144 L x 48 W x 64 H in	5-12	10-15	26 ft 1 in x 31 ft 5 in	Natural	\$38,821.95
6-2104592-670	Timber Glen, With Shade	144 L x 48 W x 64 H in	5-12	10-15	26 ft 1 in x 31 ft 5 in	Playful	\$38,821.95
6-2105112-670	Timber Glen, No Shade	15-½ x 14 ft	5-12	10-15	26 x 31-½	Playful	\$24,481.95
6-2105115-670	Timber Glen, No Shade	15-½ x 14 ft	5-12	10-15	26 x 31-½	Natural	\$24,481.95
5-2104591-670	Timber Glen - Anchor Kit	12 L x 9 W x 5 H in	5-12	-	-	-	\$525.95
5-2104593-670	Timber Glen - Inground Kit	48 L x 48 W x 24 H in	5-12	-	-	-	\$1,186.95



**UltraPlay® Systems Moon Crater Climber**

Constructed of durable roto-molded plastic featuring three ground level entry points. This climber offers a variety of hand and foot holds for ease of access and excellent supervision qualities. Ages 2-12. Capacity 6-8. Color as shown. Surface mount kit included (in-ground kit sold separately).

Item #	Use Zone	List Price
6-2028065-670	21 ft Diameter	\$8,233.95
Inground Kit		
6-2028070-670	-	\$339.95



**UltraPlay® Systems Whirl and Twirl**

The Whirl & Twirl spinner bowl encourages social interaction as one child rides while the other spins them around. The tilted design increases spinning momentum, and helps individual children use the product without having another person spin them. Drain holes help prevent standing water, and the rounded lip allows children to hold on during use as well as aiding in transition in and out of the bowl.

Item #	Use Zone	List Price
6-2010571-670	15 ft 7 in x 15 ft 7 in	\$1,694.95





A PLAYCORE Company



**UltraPlay® Systems Climb and Discovery Cave**

Children will discover new nature details each time they play on the Climb & Discovery Cave as they encounter mushrooms, iguanas, salamanders, ants, birds and more. Ages 2-12. Large openings offer crawl through points and allow for easy interior supervision. Professional hand holds available in 2 color schemes. Use Zone 20 x 21 ft.

Item #	Description	Product Dimensions	Base Core Color	List Price
<b>Standard Hand Holds</b>				
6-2027812-670	Climb and Discover Cave	104 W x 86 D x 40 H in	Natural	\$8,734.95
<b>Letter and Number Hand Holds</b>				
6-2027813-670	Climb and Discover Cave	104 W x 86 D x 40 H in	Playful	\$8,734.95



**UltraPlay® Systems Mountain Twist**

This freestanding climber creates a realistic climbing experience with an angled shape providing multiple levels of challenge. The natural color palette enhances the play environment. Ages 5-12

Item #	Use Zone	List Price
6-2010570-670	22 x 23 ft	\$6,097.95



**UltraSite™ Buddy Bench**

Add this new trend in seating to any space to provide an area that children can go if they are feeling lonely or left out on the playground. This signals other children on the playground that they would like to be included. Buddy Bench features kid friendly letters and graphics. Durable thermoplastic finish. Choose from 6 or 8 foot bench lengths, Diamond or Perforated pattern, surface mounts, and color.

Item #	Description	Product Dimensions	Color	Base/Mount Type	Pattern Type	List Price
6-1572692-670	6 ft Buddy Bench	72 L x 22-1/4 D x 35 H in	Specify	Specify	Diamond	\$1,602.95
6-1572693-670	6 ft Buddy Bench	72 L x 22-1/4 D x 35 H in	Specify	Specify	Perforated	\$1,692.95
6-1572694-670	8 ft Buddy Bench	96 L x 22-1/4 D x 35 H in	Specify	Specify	Diamond	\$1,646.95
6-1572695-670	8 ft Buddy Bench	96 L x 22-1/4 D x 35 H in	Specify	Specify	Perforated	\$1,809.95

**Ultra Site® Thermoplastic Finish Colors**



**UltraPlay® Flower Collection Ensemble**

The Flower Collection features four flowers each with a distinct musical chord, size, height, and color, and when the petals are struck they emit a rich, long-sustaining gong. The Flowers add both a sculptural and aesthetic design that invites users both young and old to create music in an outdoor environment.

Item #	Description	Product Dimensions	Age Range	Base/Mount Type	List Price
6-2038852-670	Flower Collect Inground	47 W x 43 D x 24 H in	All ages	In-Ground	\$13,767.95



### Ultra Play® Swing Bays

The Bipod Swings features a 8 ft. high single bay frame with 2-3/8" galvanized pipe top rail and 2-3/8" diameter legs. Powder coated blue (BLU) or green (GRN) yoke connectors. Seats, swing hangers, chain and factory-closed S-hooks included with swing seats. Ages: 2-12. Commercial strap seats, tot seats, or inclusive seats.

Item #	Description	Product Dimensions	Color	Starter/Adder	List Price
<b>Single Bay</b>					
6-1478668-670	Bipod Swings 2 Strap Seats	102 W x 96 D x 96 H in	-	Starter	\$3,624.95
6-1478670-670	Bipod Swings 2 Tot Seats	102 W x 96 D x 96 H in	-	Starter	\$4,096.95
<b>Double Bay</b>					
6-1478664-670	Bipod Swings 4 Strap Seats	198 W x 96 D x 96 H in	-	Starter	\$6,019.95
6-1478767-670	Bipod Swings 2 Strap 2 Tots	198 W x 96 D x 96 H in	-	Starter	\$6,568.95
6-1478666-670	Bipod Swings 4 Tot Seats	198 W x 96 D x 96 H in	-	Starter	\$7,038.95
<b>Swing Seat</b>					
6-1478674-670	Commercial Strap Seat Package	18 W x 24 D x 24 H in	Black		\$775.95
6-1478672-670	Commercial Tot Seat Package	18 W x 24 D x 24 H in	Black		\$1,013.95



### Ultra Play® Inclusive Swings

Inclusive Swing Seat Package is one of the only full-support seats that is age and size specific, while offering therapeutic benefits such as movement and perceptual skills. The swings are available in two age ranges, (2-5 or 5-12). Available in playful, (Blue seat with Yellow brace) or natural, (Green seat with Beige brace). Offers a smooth and synchronized movement pattern. Packages include (1) seat, (2) hangers, (1) seat brace (2) chains with clevis attachments.

Item #	Description	Product Dimensions	Color	List Price
6-2104595-670	Swing Seat Package - Ages 2-5	17 L x 23 W x 28-1/2 H in	Natural	\$1,374.95
6-2104598-670	Swing Seat Package - Ages 2-5	17 L x 23 W x 28-1/2 H in	Playful	\$1,374.95
6-2104596-670	Swing Seat Package - Ages 5-12	17 L x 23 W x 34 H in	Natural	\$1,419.95
6-2104597-670	Swing Seat Package - Ages 5-12	17 L x 23 W x 34 H in	Playful	\$1,419.95





**UltraPlay® Deer Creek**

A favorite option for a play area with a small footprint. Children can climb up the Vine or Beanstalk Climber, cross through the Crawl Tunnel and slide down the Curve Slide. Three ground-level music components offer creative play for children of all abilities. Ages 2-12. Capacity is 15-20 and includes 7 activities. Color: Playful or Natural. Ground spike kit included (Anchor Bolt and Inground Kit sold separately).

Item #	Description	Product Dimensions	Age Range	Capacity	Use Zone	List Price
6-2104590-670	Deer Creek - Natural	144 L x 48 W x 64 H in	2-12	15 to 20	25 ft 9 in x 27 ft 5 in	\$18,625.95
6-2104588-670	Deer Creek - Playful	144 L x 48 W x 64 H in	2-12	15 to 20	25 ft 9 in x 27 ft 5 in	\$18,625.95
5-2104594-670	Deer Creek - Anchor Kit	-	-	-	-	\$455.95
5-2104589-670	Deer Creek - Inground Kit	-	-	-	-	\$963.95



**UltraPlay® South Fork**

The most fun you'll find in a one deck structure. The South Fork boasts exciting climbing, sliding and music opportunities. The nature-themed roof also helps keep kids cool as they explore the South Fork. Ages 2-12. 6 activities. Playful or natural color. Ground spike kit included (Anchor Bolt and Inground Kit sold separately).

Item #	Description	Product Dimensions	Age Range	Capacity	Use Zone	List Price
6-2028062-670	South Fork - Natural Color	169 W x 148 D x 168 H in	2-12	10 to 15	26 ft 4 in x 24 ft 4 in	\$16,528.95
6-2028069-670	South Fork - Playful Color	169 W x 148 D x 168 H in	2-12	10 to 15	26 ft 4 in x 24 ft 4 in	\$16,528.95
6-2028067-670	South Fork Anchor Bolt	-	-	-	-	\$398.95
6-2028063-670	South Fork Inground Kit	-	-	-	-	\$785.95

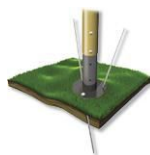

Ground Spike Mount



Inground Mount



Anchor bolt Mount



### Action Play Systems GaGa2Go Pit

The Action Play Systems GaGa2Go Ball Pit provides students with indoor or outdoor exercise and fun. This kit includes 16 border panels that interlock to create a 20-foot pit. Assembly is fast and easy; no hardware is needed. Durable recycled plastic construction is lightweight so kids can assist with setup and storage. Panels nest when stacked to take up minimal space in your school. Lightweight and portable for indoor or outdoor use. Interlocking panels are easy to assemble and break down panels nest for compact storage. Includes a one-year limited warranty.



Item #	Description	Product Dimensions	Age Range	List Price
6-2089136-670	Gaga Ball Pit - 20 Feet	236 W x 240 D x 30 H in	5+ Years	\$2,298.95

### Action Play Systems GaGa Pits

Offering three sizes of modular kits for indoor or outdoor use. Each kit comes complete with stanchions and borders as well as a standard ADA gate for entry to create the GaGa Pit. Each wall of the pit is constructed of 4" sections of double stacked borders resulting in side panels that are 28" high. This allows for maximum ball rebound and easy pit entrance and exit. Our design keeps the pit panels raised 4" for easier pit cleaning of debris.



Item #	Description	Product Dimensions	Age Range	List Price
6-1581874-670	Gaga Ball Pit - 15 Feet	144 W x 144 D x 28 H in	5+ Years	\$2,969.95
6-1581875-670	Gaga Ball Pit - 20 Feet	192 W x 192 D x 28 H in	5+ Years	\$4,062.95
6-2022268-670	Gaga Ball Pit - 26 Feet	312 W x 284 D x 28 H in	5+ Years	\$4,906.95

### Action Play Systems Border and Spikes

Action Play Systems offers the highest quality playground border in the industry. APS playground borders are 4' 4" long, 4" wide and available in either 8" or 12" heights. Our 8" high playground borders are perfect for Early Childhood environments, or when using rubber mulch and when only a 6" depth of loose fill surfacing is required. The 12" high APS playground border is perfect for all other applications. Offering a 10-year limited warranty, our product is designed to take the place of wood timbers and offers a permanent, maintenance free solution.

Item #	Description	List Price
6-1581867-670	8 in High Border w/ Spike	\$80.95
6-1581868-670	12 in High Border w/ Spike	\$83.95
9-1581869-670	18 Inch Spike	\$23.95
9-1581870-670	28 Inch Spike	\$28.95



### Action Play Systems Swing/Slide Mat

These swing & slide mats are perfect to reduce the amount of maintenance required and ensure your safety surfacing stays in place in these high traffic areas on your playgrounds.

Item #	Product Dimensions	List Price
6-1581876-670	40 W x 40 D x 1-1/2 H in	\$295.95
6-1581877-670	36 W x 60 D x 2 H in	\$451.95

### Action Play Systems Triple Shoot

Triple Shoot is the most recent update for the classic Funnel Ball Game, the perfect addition for any playground area! Triple Shoot Features a catching basket with (3) openings that are numbered to bring more guidance to the desired game mode and, a 8' pole. This will help to promote gross motor skills and interaction between the children as they play together.

Item #	Product Dimensions	Color	List Price
6-1581873-670	41-5/8 Dia x 84 H in	Orange	\$1,195.95
6-2027585-670	41-5/8 Dia x 84 H in	Green	\$1,195.95





playful color shown

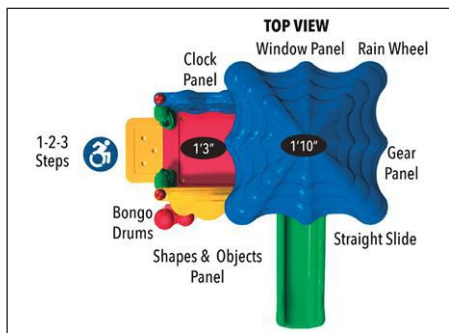

### UltraPlay® Discovery Center Seedling

This two deck structure features a multitude of activities for 6-23 months old, while offering nature inspired detail integrated throughout the structure. Children will stay active with their friends as they engage with the interactive components which includes seven activities. Use Zone 13 ft 7 in x 13 ft 4 in. Color options playful or natural. Available in roof or no roof option (natural only available in Seedling with roof). Choice between anchor bolt or ground spike mounting (inground kit sold separately).

Item #	Description	Product Dimensions	Age Range	Capacity	Base Core Color	List Price
6-2028058-670	Seedling, W/Roof, Anchor Bolt	101 W x 162 D x 109 H in	6 - 23 months	8 to 10 children	Natural	\$10,231.95
6-2028071-670	Seedling, W/Roof, Ground Spike	101 W x 162 D x 109 H in	6 - 23 months	8 to 10 children	Natural	\$10,231.95
6-1478654-670	Seedling, W/Roof, Ground Spike	91 W x 94 D x 110 H in	6 - 23 months	1 to 12 children	Playful	\$10,231.95
6-1478653-670	Seedling, W/Roof, Anchor Bolt	91 W x 94 D x 110 H in	6 - 23 months	1 to 12 children	Playful	\$10,231.95
6-1478652-670	Seedling, No Roof, Ground Spike	91 W x 94 D x 91 H in	6 - 23 months	1 to 12 children	Playful	\$8,442.95
6-1478651-670	Seedling, No Roof, Anchor Bolt	91 W x 94 D x 91 H in	6 - 23 months	1 to 12 children	Playful	\$8,442.95
6-1478655-670	Mounting Kit, In-ground	-	-	-	-	\$611.95

### UltraPlay® Discovery Hilltop

Discovery Centers offer a variety of standard-based developmental and educational activities that spark imagination and inspire exploration. The Discovery Hilltop features seven play activities that include musical elements, cause and effect gears, and a panel that promotes math concepts. These centers are affordable, easy to install, and allow increased teacher interaction. Choose between anchor bolt or ground spike mounting. (Inground kit sold separately)

Top View

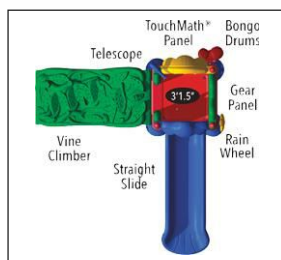

Item #	Description	Product Dimensions	Age Range	Capacity	Use Zone	List Price
6-1478639-670	Discovery Center, Ground Spike	12 W x 10 D x 6-1/2 H ft	2 - 5 years	1 to 12 children	22 x 22 ft	\$7,417.95
6-1478640-670	Discovery Center, Anchor Bolt	12 W x 10 D x 6-1/2 H ft	2 - 5 years	1 to 12 children	22 x 22 ft	\$7,417.95
6-1478655-670	Mounting Kit, In-ground	-	-	-	-	\$611.95

### UltraPlay® Discovery Range

Discovery Centers offer a variety of standard-based developmental and educational activities that spark the imagination and inspire exploration. Children will love playing with their friends on the Discovery Range, which offer a variety of 13 play activities and can accommodate up to 25 children. These centers are affordable, easy to install, and allow increased teacher interaction. Choose between anchor bolt or ground spike mounting. (inground kit sold separately). Also available in Natural color (see top view). Contact School Specialty Representative for more details.

Top View

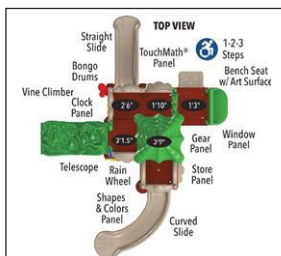

Item #	Description	Product Dimensions	Age Range	Capacity	Use Zone	Base Core Color	List Price
6-1478645-670	Discovery Center, Ground Spike	16 W x 15 D x 11 H ft	2 - 5 years	20 to 25 children	32 ft 4 in x 27 ft 3 in	Playful	\$21,371.95
6-1478646-670	Discovery Center, Anchor Bolt	16 W x 15 D x 11 H ft	2 - 5 years	20 to 25 children	32 ft 4 in x 27 ft 3 in	Playful	\$21,371.95
6-1478655-670	Mounting Kit, In-ground	-	-	-	-	-	\$611.95



## angeles

### Angeles® SilverRider® Trikes

#### SilverRider Trikes feature:

- Comfort back support
- Heavy-duty rubber handgrips
- Durable chrome plating and welded steel frame
- Recessed hub design
- Long-lasting, self-lubricating nylon bearings
- One-piece welded crank, no exposed hardware on pedals
- Solid rubber tires on spokeless steel wheels
- Replacement parts and lifetime service available
- Easy 1-bolt assembly required
- Accommodates children up to 70 lbs.
- 5-year warranty



Item #	Description	Product Dimensions	Age Range	List Price
5-1451939-670	10 Inch Trike	10 in H	3 - 4 years	\$432.95
5-1452058-670	12 Inch Trike	12 in H	3 - 5 years	\$454.95
5-1451940-670	14 Inch Trike	14 in H	4 - 8 years	\$488.95



## angeles

### Angeles® SilverRider® Super Cycle

Handlebars 20" H. Seat 5 1/2" H. 28 lbs. Accommodates up to 70 lbs.

Item #	Description	Product Dimensions	Age Range	List Price
5-1451941-670	SilverRider Super Cycle	34 L x 22 W x 22 H in	4 - 6 years	\$511.95



**NEW**

### Radio Flyer® 3 in 1 EZ Fold Wagon with Canopy

Radio Flyer's 3-in-1 EZ Fold Wagon® with Canopy is designed as a full-sized wagon for kids that folds compactly and offers 3 different modes: 2 kids riding, flatbed hauling, and bench seating. With an easy one hand fold, you can take or store the wagon anywhere! The high seat backs and thick padded seat with seatbelts provide a comfortable ride. Maximum weight capacity 150lbs.

Item #	Description	Product Dimensions	Age Range	List Price
5-2099563-670	3-In-1 EZ Fold with Canopy	26 1/5 L x 7 1/3 W x 19 9/10 H	18+ months	\$269.95

## angeles

### Angeles® ClassicRider® Trikes

#### ClassicRider Trikes feature:

- Durable red powder-coated, welded steel frame
- Comfort back support
- Heavy-duty rubber handgrips
- Recessed no-pinch hub design
- Long-lasting, self-lubricating nylon bearings
- One-piece welded crank
- Non-exposed pedal hardware
- Solid rubber tires on spokeless steel wheels
- Easy 1-bolt assembly required
- Accommodates up to 70 lbs.
- 5-year warranty



Item #	Description	Product Dimensions	Age Range	List Price
5-1451931-670	10 Inch Trike	10 in H	3+ Years	\$412.95
5-1451932-670	12 Inch Trike	12 in H	3 - 5 years	\$432.95
5-1451933-670	14 Inch Trike	14 in H	4 - 8 years	\$480.95



Toddler



Child

### Trike Helmets

Safe, durable and stylin'! These helmets meet or exceed ANSI Z90.4, CPSC and Snell B95A certifications. Features a vented design for maximum comfort. Blue, 1-year warranty.

Item #	Description	Product Dimensions	Age Range	List Price
9-1451651-670	Helmet Toddler Size	18-20 in	1 - 3 years	\$47.95
9-1451652-670	Helmet Child Size	20 in	3 - 7 years	\$47.95



### Radio Flyer® Wagons

Take a roll down memory lane with the original family wagon! These wagons are finished with safe and durable non-toxic paint. Two models to choose from: Classic Red Wagon (steel) or the Town and Country Wagon (wood). Wheel size is 10" x 1 1/2".

Item #	Description	Product Dimensions	Age Range	List Price
5-2028796-670	Classic Red Wagon	39-1/2L x 17-1/2W x 14-1/3H in	18+ months	\$360.95
5-2028797-670	Town & Country Wagon	39-3/8L x 18-7/8W x 19-3/4H in	18+ months	\$432.95



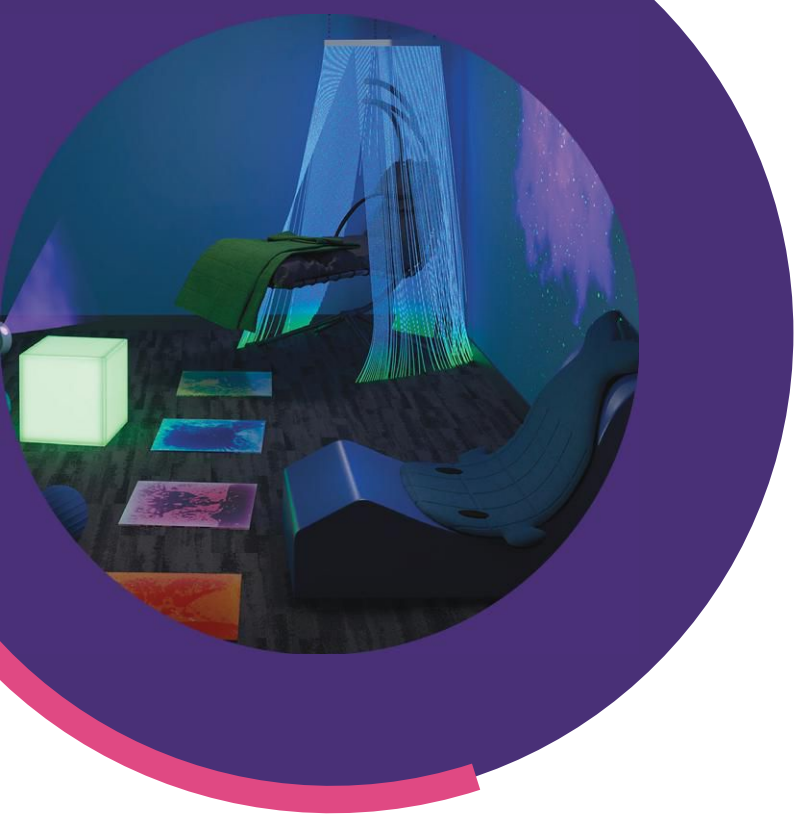

# special needs

**NEW**



## TFH Leaf Chair with Stand

An elegant and extremely comfortable chair that is cleverly balanced to give a gentle movement. The strong galvanized steel frame is padded throughout with easy wipe vinyl liner. Weight limit of 225 pounds. Leaf Chair comes with robust galvanized steel stand.

Item #	Description	Product Dimensions	Color	Age Range	Quantity	List Price
6-2096536-670	Leaf Chair with Stand	73 L x 46 W x 78 H in	Graphite/Silver	5+ years	Each	\$1,233.19

**NEW**



## Color Changing Sensory Mood Shapes

These ultra-strong illuminated shapes can be placed anywhere around the room or even outdoors! Using the remote control, you can choose one of 16 different colors or set to fade through a spectrum of shades. Mood shapes are rechargeable and produce 10 hours of light per charge. Use under adult supervision

Item #	Description	Product Dimensions	Color	Age Range	Quantity	List Price
9-2100433-670	Egg	9 Dia x 13 H in	Multi Color	3+ years	Each	\$243.89
9-2100428-670	Ball	16 Dia in	Multi Color	3+ years	Each	\$243.89
9-2100436-670	Cube	16 L x 16 W x 16 H in	Multi Color	3+ years	Each	\$333.89



**Abilitations**

## Abilitations® Sensory Floor Tiles

Visually appealing and pleasing, Abilitations® Sensory Floor Tiles are a fun and creative way to stimulate the senses. Touch or step on the tile to feel the liquid flow from one side to the other. Watch as the color swirls around and create patterns within the tile. Tiles measure 19-1/2 x 19-1/2 inches and filled with non-toxic fluid.

Item #	Description	Age Range	Quantity	List Price
<b>Square Tiles</b>				
9-2024605-670	Square Blue Tile	3+ years	Each	\$79.69
9-2024609-670	Square Green Tile	3+ years	Each	\$79.69
9-2024604-670	Square Purple Tile	3+ years	Each	\$79.69
9-2024607-670	Square Orange Tile	3+ years	Each	\$79.69
9-2091786-670	Square Tile Set <b>NEW</b>	3+ years	Set of 4	\$291.19
<b>Round Tiles</b>				
9-2104601-670	Round Tile Set <b>NEW</b>	3+ years	Set of 4	\$291.19



**TFH USA Bubble Wall**

The 60" Bubble Wall is a great way to save space especially in a sensory room. The speed of the bubbles can be controlled by a switch controller. The bubble wall is used to create a relaxing and stimulating visual experience. Distilled water is needed (not included). Wall mount only. Adult supervision at all times.

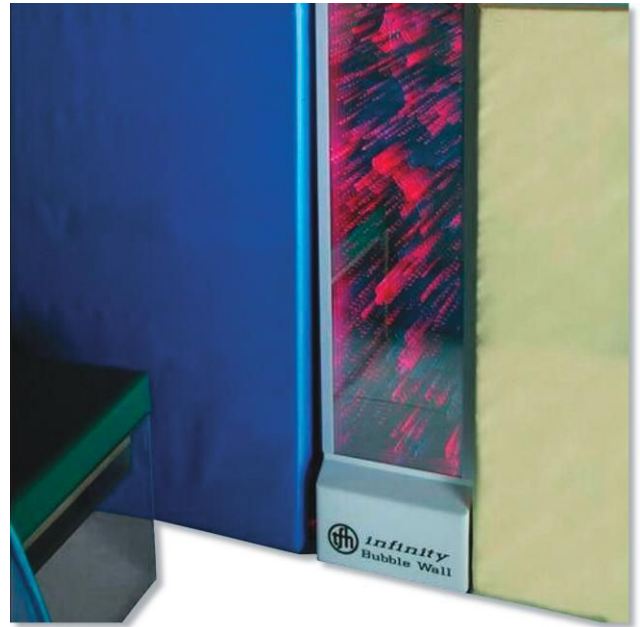

**TFH Infinity Bubble Wall**

The Interactive Bubble Wall is a very common piece of equipment in sensory spaces. The bright and lively colors of this interactive controlled bubble tube offer a relaxing and stimulating visual experience. Confidence builds with the ability to manipulate the range of color options and speeds. Distilled water is needed (not included). Adult supervision at all times.

Item #	Description	Product Dimensions	Age Range	Quantity	List Price
9-2089262-670	Bubble Wall 60 Inch	16 W x 3 D x 60 H in	3+ years	Each	\$3,584.29

Item #	Description	Product Dimensions	Age Range	Quantity	List Price
9-2089279-670	Infinity Bubble Wall	16 W x 3 D x 60 H in	3+ years	Each	\$3,646.19



**Experia® USA Bubble Wall**

The Bubble Wall is an excellent addition to any multi-sensory space with hundreds of bubbles flowing steadily upwards while its colors slowly change. It's wall-mounted and is ideal for use in areas where space might be an issue. Adult supervision is required. Ages 3+.



**Experia® USA Interactive Fanlite**

The Interactive Fanlite is a great way to encourage vocalization! Speak and you shall see! This Interactive Fanlite is the ultimate in cause and effect and a perfect sensory tool for those with sensory, cognitive, or speech challenges. As you vocalize the fan lights up its magnificent colors. The Fanlite uses LED technology to provide crisp, bright colors which can be controlled in eight different modes: three automatic and five that are activated by sound. Features sensitivity and speed controls, an internal microphone, and socket for external microphone. Adult supervision required. Ages 3+.

Item #	Description	Product Dimensions	Color	Age Range	Quantity	List Price
5-1582720-670	Bubble Wall	22 W x 5 D x 72 H in	Assorted	Ages 3+	Each	\$7,021.19

Item #	Description	Product Dimensions	Quantity	List Price
5-1388940-670	Interactive LED Fanlite	55 W x 5-1/2 D x 32 H in	Each	\$5,931.79



please see our website for additional products  
[SchoolSpecialty.com/special-needs](http://SchoolSpecialty.com/special-needs)



- Choose Height
- Choose Control Option
- Choose Calming vs. Superactive
- Choose Platform
- Choose Mirrors

**Experia® USA Bubble Tubes**

Watch and listen to the soothing sound of rising bubbles in a variety of Experia® Bubble Tubes. Ideal for relaxation or stimulation, bubble tubes are the foundation of a sensory room experience and usually the first piece of equipment an individual will notice and engage with. For tubes 60" and over, the bubble tube bracket is recommended to ensure stability. Adult supervision is required. Ages 3+.

Item #	Description	Product Dimensions	Quantity	List Price
5-1392961-670	Portable Bubble Tube	40 in H	Each	\$2,292.59
5-1367095-670	Calming LED Bubble Tube	60 in H	Each	\$3,386.49
5-1367096-670	Calming LED Bubble Tube	80 in H	Each	\$3,386.49
5-1367098-670	Superactive with Controller	60 in H	Each	\$5,115.99
5-1367099-670	Superactive with Controller	80 in H	Each	\$5,115.99
5-1582734-670	Superactive LED Bubble Tube	60 in H	Each	\$6,592.49



**Experia® USA Bubble Tube Platforms**

The Bubble Tube Platforms fit any 6" diameter bubble tube and allows a user to sit close to the bubble tube and feel its vibrations. This platform is covered in soft, durable, easy-to-clean vinyl, and comes in White.



Item #	Description	Product Dimensions	Color	Quantity	List Price
6-1388947-670	Curved Platform - Medium	36 W X 36 L X 16 H in	White	Each	\$1,691.49
6-1388948-670	Curved Platform - Large	48 W X 48 L X 16 H in	White	Each	\$1,947.19
6-1388945-670	Square Platform - Medium	36 W x 36 L x 16 H in	White	Each	\$1,792.39
6-1388946-670	Square Platform - Large	48 W x 48 L x 16 H in	White	Each	\$2,206.29



**Experia® USA Bubble Tube Acrylic Mirrors**

Bubble Tube Mirrors are a must when installing a bubble tube and platform. The safe, acrylic mirror mounts easily to your wall (in the corner) and quadruples the experience. Mirrors are made from a safe acrylic material and will not shatter like glass, making them a safe alternative. Bubble Tube and Platform sold separately.

Item #	Description	Product Dimensions	Quantity	List Price
5-1473842-670	Bubble Tube Mirror Pair	36 W x 48 H in	Each	\$672.09
5-1473844-670	Bubble Tube Mirror Pair	48 W x 48 H in	Each	\$916.49

**Experia® USA BCB Fluid and Pump & Hose Kit**

The Bubble Tube BCB Cleaner Fluid slows down the process of bacteria production, while the Tube Pump and Hose Kit helps keep your Bubble Tube clean and bacteria free.

Item #	Description	Quantity	List Price
9H-1367101-670	Bubble Tubes BCB	Each	\$136.99
9-1367102-670	Pump and Hose	Each	\$278.89







A



B



C



D

ENTIRE PAGE  
NEW



- Choose Water vs Waterless
- Choose Height
- Choose Platform

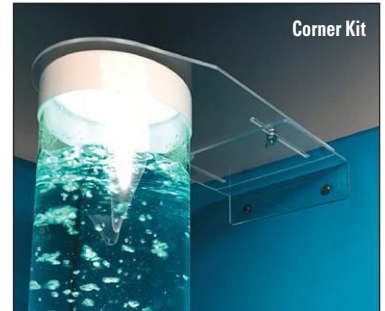

E

### TFH USA Hurricane and Bubble Tubes

The first thing to catch the eye upon entering a TFH Sensory Room is the stunning Bubble Tubes and Hurricane Tubes. TFH offers a variety of size options from water based Bubble Tubes to the waterless Hurricane Tubes. Adult supervision is required. Ages 3+.

Item #	Description	Product Dimensions	Quantity	List Price
A 9-2104399-670	Tabletop Hurricane Tube	27-1/2 in H	Each	\$930.19
B 6-2105459-670	Bubble Tube	80 in H	Each	\$3,766.29
C 6-2100430-670	Genie Hurricane Tube	80 in H	Each	\$5,007.59
D 6-2100426-670	Hurricane Tube	80 in H	Each	\$5,599.39
E 6-2105887-670	Bubble Tube Corner Kit	80 in H	1 Set	\$5,623.89



F



G



H



I

### TFH USA Tube Podiums

Have a comfortable seat next to your TFH Bubble or Hurricane Tube. Select from a variety of podium and benches to create your own sensory room.

Item #	Description	Product Dimensions	Color	Quantity	List Price
F 6-2089269-670	Corner Mirrored Podium	36 L x 36 W x 18 H in	White	Each	\$1,170.59
G 6-2100427-670	Square Bench	36 L x 36 W x 18 H in	White	Each	\$1,278.69
H 6-2100434-670	Quadrant Bench	36 L x 36 W x 18 H in	White	Each	\$1,529.19
I 6-2100435-670	Quadrant Tube Podium	36 L x 36 W x 18 H in	White	Each	\$1,529.19



**Experia® USA Fiber Optic Carpets**

Experia® USA's Fiber Optic Carpet uses tiny fiber-optic lights to light up the black carpet. Produce a galaxy of color to create a calming or interactive multi-sensory experience for the user, depending on the model chosen. Adult supervision is required. Ages 3+

Item #	Description	Product Dimensions	Quantity	List Price
5-1397560-670	Calming Star Carpet	79 W x 39 H x 1 D in	Each	\$3,484.39
5-1367299-670	Superactive Star Carpet	79 W x 39 H x 1 D in	Each	\$4,190.39
5-2038820-670	IRIS Star Carpet	79 W x 39 H x 1 D in	Each	\$4,376.89
5-1397565-670	Calming LED Wall Carpet	79 W x 39 H x 2 D in	Each	\$4,102.29
5-2038822-670	Superactive LED Wall Carpet	79 W x 39 H x 2 D in	Each	\$4,797.49
5-2038821-670	IRIS LED Wall Carpet	79 W x 39 H x 2 D in	Each	\$4,986.19

**Experia® USA Fiber Optic Softie**

The Fiber Optic Softie is a large bean bag cushion with an integrated light source and fiber optics. It allows the user to sit comfortably on a bean bag with fiber optics to hold, look at, touch, and feel, creating a sense of peace, well-being, and yet attentiveness. The Fiber Optic Softie creates a great visual and tactile experience, and it can be used to calm and relax or stimulate depending on the model chosen. This product includes a Softie Bean bag, a light source (Calming, Superactive, or IRIS), a 150-strand x 2m Fiber Optic Sideglow, and a low voltage transformer. Dimensions: 51 D x 18 H inches. Adult supervision is required. Ages 3+.

Item #	Description	Product Dimensions	Quantity	List Price
6-1397575-670	Calming	51 D x 18 H in	Each	\$3,844.39
6-1388949-670	Superactive	51 D x 18 H in	Each	\$4,572.19
6-1483367-670	IRIS	51 D x 18 H in	Each	\$6,290.29

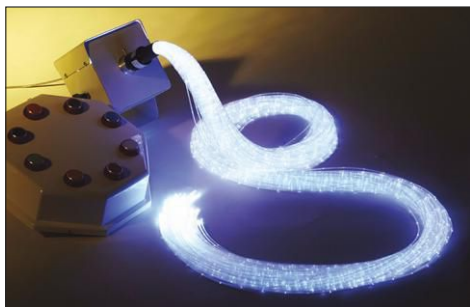

Superactive Bundle

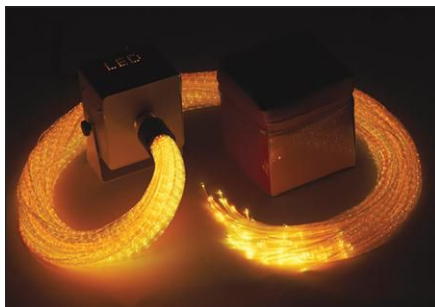

IRIS Bundle



Superactive Dual Controllers

**Experia® USA Fiber Optic Bundles**

These units are great for schools, hospitals, nursing homes, or almost any environment. Wonderfully tactile, the fiber optics can be laid across a person's lap to create a close, hands-on experience. Fiber Optic Bundles can be used to calm and relax or stimulate depending on the model chosen. If the controller is left untouched for five minutes (Superactive models), the light source goes into "calming" mode, slowly changing through a rainbow of colors. This mode can be used for relaxation or de-escalation for individuals with Dementia and Autism. Dimensions of fiber optic strands: 78" x 150 strands Dimensions are approximate. Adult supervision required. Ages 3+.

Item #	Description	Product Dimensions	Quantity	List Price
5-1367298-670	Superactive Fiber Optic Bundle	6-1/4 W x 5 D x 8-1/4 H in	Each	\$3,497.99
5-1582735-670	Superactive Dual Controllers	6-1/4 W x 5 D x 8-1/4 H in	Each	\$5,447.49
5-1397566-670	Iris LED Fiber Optic Bundle	6-1/4 W x 5 D x 8-1/4 H in	Each	\$5,680.99

**Experia® USA Fiber Optic Raincloud**

Go for a walk in the rain without getting wet with the Fiber Optic Raincloud! A perfect addition to any sensory room, the Fiber Optic Raincloud features 150 "raindrops" of vibrant, glowing fiber optics that slowly change colors in a serene, calming pattern. The Fiber Optic Raincloud can be either relaxing or stimulating, depending on the model chosen. Comes complete with 150 strands of fiber optics, a high-quality light source and low voltage transformer, two decorative thunderbolts, and all the necessary hardware to mount onto a wall with drywall construction. Adult supervision is required. Ages 3+.

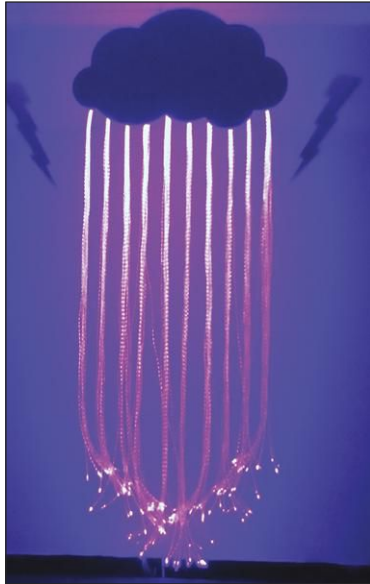

Item #	Description	Product Dimensions	Quantity	List Price
5-1582725-670	Calming Raincloud	34 W x 11 D x 16 H in	Each	\$3,068.99
5-1582726-670	Superactive Raincloud	34 W x 11 D x 16 H in	Each	\$4,033.29
5-1582727-670	IRIS Raincloud	34 W x 11 D x 16 H in	Each	\$4,159.49

**Experia® USA Fiber Optic Wall Cascade**

Fiber Optic Wall Cascade uses the latest technology to create a shimmering cascade of fiber optics giving the illusion of a color-changing curtain. Mount over a doorway or on a wall for a fabulous addition to any sensory environment. The Fiber Optic Wall Cascade is easily accessible for wheelchair users thanks to the swiveling wall-mounted bracket. Depending on the model chosen, the Fiber Optic Wall Cascade can be either relaxing or stimulating. Dimensions: Enclosure: 10" H x 28 3/4" W x 7" D. Fiber optics: 8 ft x 150 strands. Adult supervision is required. Ages 3+.



Item #	Description	Product Dimensions	Quantity	List Price
5-1397561-670	Calming Cascade	28 W x 7 D x 10 H in	Each	\$4,275.79
5-1367300-670	Superactive Cascade	28 W x 7 D x 10 H in	Each	\$4,385.29

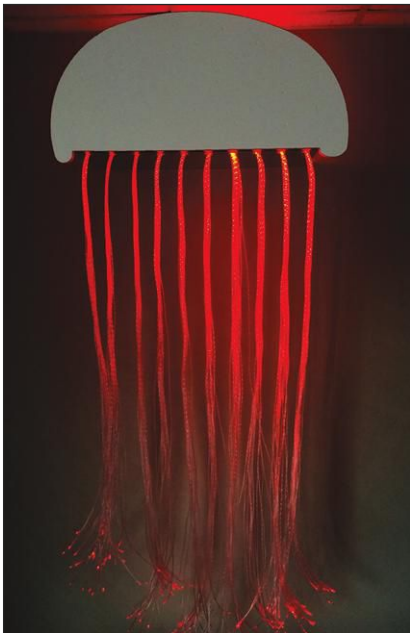

**Experia® USA Fiber Optic Jellyfish**

A perfect addition to any sensory room, the Fiber Optic Jellyfish features 150 "tentacles" of vibrant, glowing fiber optics that slowly change colors in a serene, calming pattern. Look up, and you will see yourself in the mirror that is mounted underneath, watching the tentacles go off into the distance! It creates a truly immersive experience. The Fiber Optic Jellyfish can be either relaxing or stimulating, depending on the model chosen. Adult supervision required. Ages 3+.

Item #	Description	Product Dimensions	Quantity	List Price
5-1582722-670	Calming Fiber Optic Jellyfish	34 W x 11 D x 16 H in	Each	\$2,793.59
5-1582723-670	Superactive Fiber Optic	34 W x 11 D x 16 H in	Each	\$4,033.29
5-1582724-670	Iris Fiber Optic Jellyfish	34 W x 11 D x 16 H in	Each	\$4,067.09

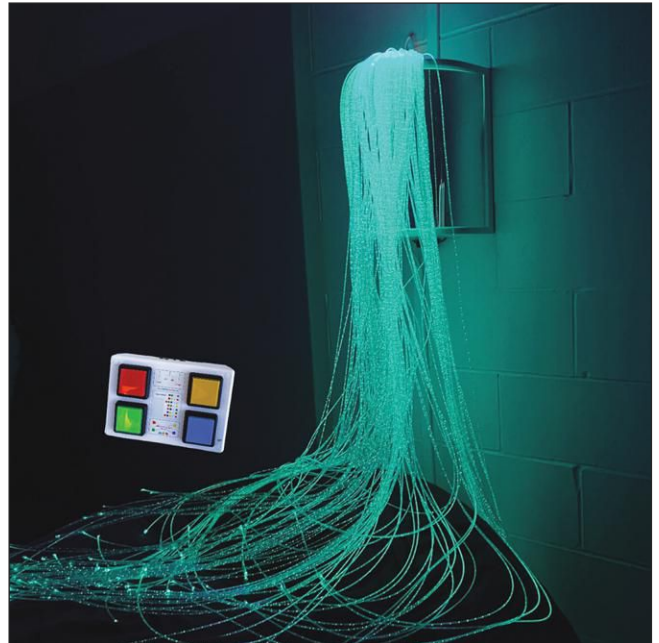

**TFH Fiber Optic Scence**

Now you can enjoy a cascade of glowing, color changing fiber optic tail strands with the Wireless Fiber Optic Scence. The rounded scence encloses and protects the light source allows the lights of your room to reflect off to the mirrored front. This unit offers a relaxing and stimulating visual experience. Adult supervision at all times.

Item #	Description	Product Dimensions	Quantity	List Price
9-2089266-670	Wireless Fiber Optic Scence	15 L x 10 W x 80 H in	Each	\$3,732.99





**Experia® USA Aurora Projector**

A sensory room wouldn't be a sensory room without a projector! This is a great starter kit that provides all the items to get a projector up and running. Kit includes: 1 Aurora LED Projector, 1 Wheel Rotator, and 5 Effect Wheels (Balloon Extravaganza, Dawn til Dusk, Firework Bonanza, Outer Space and Tropical Reef). Effects wheels may be substituted based on availability.

Item #	Description	Product Dimensions	Quantity	List Price
5-1399900-670	Aurora LED Projector	17 L x 11 W x 10 H in	Each	\$1,952.79
5-1527726-670	Aurora LED Projector Set	17 L x 11 W x 10 H in	Each	\$2,543.09

**TFH Sky Lite Laser Galaxy Projector**

- Shines a universe of moving laser stars against a drifting blue nebula cloud
- Tilting design allows you to shine the effect on walls or ceiling
- Auto 6-hr timer
- USB cord with 120-240 V wall adapter

Item #	Description	Product Dimensions	Color	Age Range	Quantity	List Price
9-2100438-670	Sky Galaxy Projector	8 L x 3 W x 8 H Inches	White	3+ years	Each	\$196.89



**Living Scenery Projector Bundles**

These bundles contain everything you need, including a compact, high-lumen video projector, a DVD player, a 50-foot HDMI cable, a universal projector mount (not shown), and six DVDs. The projector has a built-in speaker, so no other audio equipment is needed; however, any stereo with an audio input can work with this DVD player as well.



Item #	Description	Product Dimensions	Color	Age Range	Quantity	List Price
9-1561111-670	Drywall Ceiling Installation	14 L x 12 W x 6 H in	Various	3+ years	Each	\$3,152.99
9-1561112-670	Dropped Ceiling Installation	14 L x 12 W x 6 H in	Various	3+ years	Each	\$3,697.89

**Experia® Mirror Ball Bundle, Rotating Mechanism with Multi-Color LED**

Create a visual effect with the Deluxe Mirror Ball Bundle. Mirror Balls are often used in a multisensory environment to awaken or stimulate the visual senses. Our mirror ball bundle comes with a rotating mechanism that can be mounted to your ceiling or hung from a hook or bracket. The deluxe LED pinspot has more than a dozen color changing modes which are easy to change by simply pressing a button on back of the pinspot. The rotating mechanism is battery operated (batteries not included), and the pinspot plugs into a standard 110v outlet. Adult supervision required.

Item #	Description	Product Dimensions	Color	List Price
9-2091412-670	Deluxe Mirror Ball	8 L x 8 W x 8 H in	Mirror	\$399.99

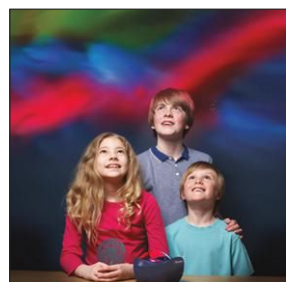

**NEW**

**TFH Northern Lights Projector**

Witness the amazing natural phenomena of the Northern Lights in your own home. The Aurora Northern Lights Projector projects this fascinating natural light show onto walls and ceilings. With multi-colored LEDs, two patterns and eight different color modes. Produces a wonderful display of moving aurora lights in any darkened room. Appropriate for ages 6 and up. Requires 3 AAA batteries.



Item #	Description	Product Dimensions	Color	Age Range	Quantity	List Price
9-2090255-670	Northern Lights Projector	7 L x 5-1/2 W x 4 H in	Purple	6+ years	Each	\$122.19



### TFH USA Vibroacoustic Therapy Chair

The Vibroacoustic Therapy Chairs magnify musical vibrations so they are felt more easily. Vinyl-covered firm foam shape cradles the body securely and rocks gently. The included Bluetooth stereo hooks up to phone or tablet. Adjustable vibration.

- Vibroacoustic Jr withstands up to 160lbs; 48 L x 18 W x 24 H Inches
- Vibroacoustic withstands up to 275lbs; 60 L x 32 W x 38 H Inches

Item #	Description	Product Dimensions	Age Range	Quantity	List Price
6-2100431-670	Vibroacoustic Jr	48 L x 18 W x 24 H in	3+ years	Each	\$3,654.09
6-2051403-670	Vibroacoustic	60 L x 32 W x 38 H in	3+ years	Each	\$5,599.99



### TFH USA Vibroacoustic Relaxer

Feel the music for therapeutic benefit. This popular reclining shape distributes body weight evenly and instantly encourages relaxation. Vibration is a great way to get the proprioceptive input to calm and stimulate. Measures 46 L x 26 W x 29 H inches and can withstand up to 250 lbs.

Item #	Description	Age Range	Quantity	List Price
6-2051402-670	Vibroacoustic Relaxer	3+ years	Each	\$3,509.99



### TFH USA Vibroacoustic Long Easy

Unique lounger that will resonate when connected with a stereo (included). The TFH Vibroacoustic Range magnifies musical vibrations so they are felt more easily. Measures 64 L x 30 W x 15 H inches and can withstand up to 199 lbs.

Item #	Description	Age Range	Quantity	List Price
6-2051399-670	Vibroacoustic Long Easy	3+ years	Each	\$3,599.99



Pillows not included

### Experia® USA Vibro-Acoustic Platform

The Vibro-Acoustic Platform is excellent for creating a soothing environment for individuals of all ages, and it fits well in just about any sensory room. Sit or lay on the platform and feel the music pulse through your entire body. Choose calming music to help reduce stress, tension, and anxiety or choose something upbeat for a stimulative effect. This system is designed to allow the streaming of music to stereo speakers and the platform, enabling independent control of the music's ambient volume and the level of vibration desired. Adult supervision is required. Each version comes complete with all the appropriate cabling and wiring necessary to set up.

Item #	Description	Age Range	Quantity	List Price
6-2012338-670	Platform - Bookshelf Speakers	3+ years	Each	\$6,545.69
6-2012340-670	Platform - Wall-Mounted	3+ years	Each	\$6,692.99
6-2012339-670	Platform - In-Ceiling Speakers	3+ years	Each	\$7,068.99



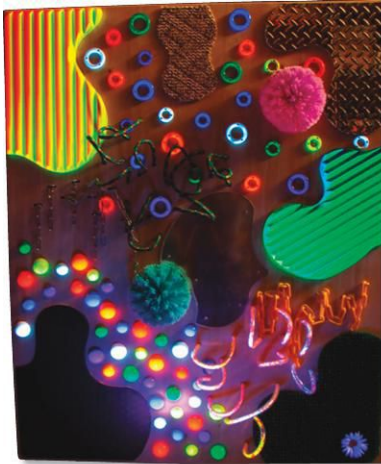

UV Textured Wall

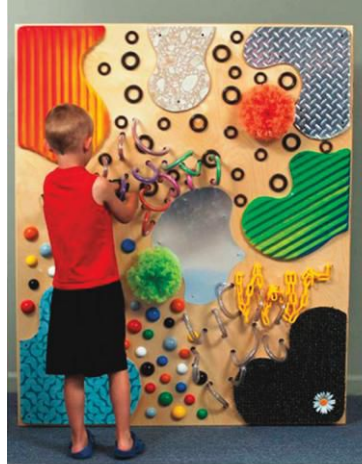

Textured Wall

**TFH® Textured Wall**

Helps the most tactile defensive learn to accept all types of textures, with 14-15 different varieties of tactile sensations. From different textures of wood, acrylic, mirrors, plastic tubing chains, vinyl, among more textures. All surfaces are wipe clean which makes a cleaning a breeze.

Item #	Description	Product Dimensions	Quantity	List Price
6-1599396-670	Textured Wall - Small	40 H x 48 W x 6 D in	Each	\$3,358.99
6-1599394-670	Textured Wall	60 H x 48 W x 6 D in	Each	\$3,850.99
6-1599395-670	UV Textured Wall	60 H x 48 W x 6 D in	Each	\$4,592.99

**TFH® Wonder Walls**

Explore, learn and experience the wonders of these tactile walls. Gravity Wonder Wall features 2 tube tracks, 3 secure hourglasses, a glitter wall and a marble wheel. The Kinetic Wall has moving parts, discs to spin, bells to ring, balls to spin and a completely new type of puzzle. Lots to inspire visual and tactile stimulation. **▲CHOKING HAZARD (1).** Not for under 3yrs.



Kinetic Wonder Wall



Gravity Wonder Wall

Item #	Description	Product Dimensions	Color	Age Range	Quantity	List Price
6-2039233-670	Kinetic Wall	39 H x 35 W x 3 D in	Multi-Colored	5+ years	Each	\$4,854.59
6-2039230-670	Gravity Wall	39-1/2 H x 36 W x 6 D in	Multi-Colored	5+ years	Each	\$5,723.29



**18 MONTHS** Crocodile Activity Wall Panels

Children will be fascinated by the colorful, tactile manipulatives on this engaging crocodile! Helps develop motor, collaborative play, communication, language and early math skills. Comes as a set of five panels, each with their own fixing holes. For indoor use only. When assembled, crocodile wall panel measure 5 feet 8-3/4 inches long.

Item #	Description	Age Range	Quantity	List Price
9-2023168-670	Crocodile Wall Panels	18+ months	Set of 5	\$325.49



**18 MONTHS** Animal Activity Wall Panels

This wooden set of 3 wall panels contains various functions and games providing a multi-sensory experience! Children will explore shapes, colors, counting and movement while building fine motor and hand-eye coordination skills. Each panel measures 21-3/4"L x 14-1/4"W.

Item #	Description	Age Range	Quantity	List Price
9-2023167-670	Animal Wall Panels	18+ months	Set of 3	\$310.39

▲Cautionary Warnings. See Page 8.



### TFH Tactile Loopie Wall

The Loopie Wall offers an incredible tactile experience with 15 different surfaces to explore. Roll balls down the tunnel and watch as they disappear and reappear, eventually popping out at the base. There are also strings to pull and spinning pattern discs.

- Offers a variety of tactile and sensory experiences
- A terrific addition to any sensory room
- Excellent tool for special needs therapy



Item #	Description	Product Dimensions	Quantity	List Price
6-1599397-670	Tactile Loopie Wall	48 W x 60 H in	Each	\$5,551.59

**NEW**

### TFH Sound & Light Panel

The Sound & Light Panel encourages the user to be more vocal, using cause and effect in a way that keeps the user intrigued for hours. Providing visual stimulation, focus, and attention, our sound sensitive Sound & Light Panel lights up in individual colors depending on the pitch of the voice or noise in the room. Adult supervision is recommended at all times.



Item #	Description	Product Dimensions	Color	Age Range	Quantity	List Price
9-1599398-670	Sound & Light Panel	24 L x 24 W x 4 H in	White	3+ years	Each	\$2,692.09

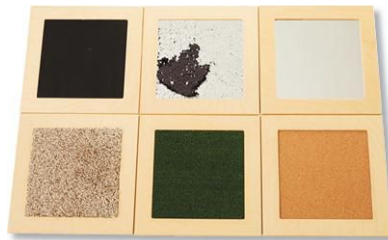

**Abilitations**

### Abilitations® Sensory Panels

Abilitations® Sensory Panels are an effective way to stimulate the senses by sight and touch. Smooth and soft or scratchy and rough, all frames are visually appealing to look at and touch. Each frame measures 15 L x 15 W x 3/4 H Inches.

Item #	Description	Age Range	List Price
9-2023275-670	Sensory Panel - Turf Grass	3+ years	\$100.99
9-2023274-670	Sensory Panel - Velcro Hooks	3+ years	\$101.99
9-2023277-670	Sensory Panel - Cork	3+ years	\$109.99
9-2023276-670	Sensory Panel - Carpet	3+ years	\$111.99
9-2020861-670	Sensory Panel - Mirror	3+ years	\$120.99
9-2023278-670	Sensory Panel - Sequins	3+ years	\$120.99
5-2024277-670	Sensory Panels - Set of 6	3+ years	\$651.99



**NEW**

### TFH Rod Wall

The Rod Wall Panel is an excellent activity for practicing fine motor skills, crossing the midline and hand/eye coordination. The large scale pegs challenge fine and gross motor skills to slot them into the predrilled holes. Hang on wall or use on tabletop. Includes 144 rods (16 each of red, green, purple, yellow, orange, blue & clear; 32 black).

Item #	Description	Product Dimensions	Color	Age Range	Quantity	List Price
6-2095545-670	Rod Wall	28 L x 22 W x 3 H in	Assorted Colorful	4+ years	Each	\$3,571.99



### Tactile Walkway Stimulation With Every Step

This unique, Tactile Walkway adds new, exciting dimensions to walking. It features six wooden frames, each with a different color and texture inside for every step. Surfaces are made from astroturf, felt, polyurethane, foam, bobbles and ribbed rubber. Frames also feature non-slip rubber feet on the bottom and measure 16" x 10" (41cm x 25cm) each.

Item #	Description	Product Dimensions	Color	Quantity	List Price
9-016962-670	Tactile Walkway	21 L x 14 W x 2-3/4 H in	Assorted	Set of 7	\$933.29



### TFH USA Tactile Column

Slimline design of our Tactile Column makes these perfect for smaller spaces with big tactile experiences. Each layer has unique tactile options for sensory development and play.

Item #	Description	Product Dimensions	Color	Age Range	Quantity	List Price
6-2039231-670	Tactile Column	47 H x 16 W x 2 D in	Multi-Colored	5+ years	Each	\$2,433.99



**Quiet Divider Colors**



**Angeles® Sound Sponge® Quiet Dividers®**

Flexible room dividers help create a separation of space with multiple configurations. Amazingly sound absorbent, lightweight, and easy to maneuver. Includes 2 low-profile support feet with glides for easy movement along the bottom edge. Hook and loop compatible; magnetic connectors easily join panels. Easy to clean with a standard carpet cleaner. Available in 3 colors: blueberry, slate blue, or natural tan. Please specify color choice when ordering.

Item #	Description	Product Dimensions	Color	List Price
5-1435558-670	Wall Divider	72 W x 3 D X 30 H in	Specify	\$845.95
5-1435560-670	Wall Divider	72 W x 3 D X 48 H in	Specify	\$1,131.95
5-1435559-670	Wall Divider	120 W x 3 D x 30 H in	Specify	\$1,158.95
5-1435561-670	Wall Divider	120 W x 3 D x 48 H in	Specify	\$1,758.95
5-1435563-670	Corner Post	2 W x 2 D x 30 H in	Black	\$202.95
5-1435562-670	Support Feet - Set of 2	18 W x 2 D x 13 H in	Black	\$129.95
5-1435564-670	Magnetic Wall Strip	3 W x 28 H in	White	\$59.95



**Cozy Shades**

Cozy shades filter out annoying hues in classrooms or cafeterias, softening the light for a "cozier" space. Designed for standard fluorescent fixtures used in schools. Each pack includes 4 flame-retardant 54"L x 24"W (137.2 x 61cm) panels. Six magnets allow for single or double swags on each fixture.

Item #	Description	Product Dimensions	Color	Quantity	List Price
9-1406261-670	Light Filters	54 L x 24 W in	Multi-Color	Pack of 4	\$79.99
9-1406260-670	Light Filters	54 L x 24 W in	Pink/Purple	Pack of 4	\$79.99
9-1406259-670	Light Filters	54 L x 24 W in	Sky Blue	Pack of 4	\$79.99
9-1406232-670	Light Filters	54 L x 24 W in	Green	Pack of 4	\$79.99

**CHILDCRAFT**  
A School Specialty Exclusive

ASSEMBLED  
IN U.S.A.  
WITH GLOBAL  
MATERIALS



PRODUCT CERTIFIED  
FOR LOW CHEMICAL  
EMISSIONS:  
UL COMF6  
UL 2816



Cozy Cube



Reflection Cozy Cube

**Childcraft® Cozy Cube**

Cozy Cube features three open circular sides to provide visibility and one solid side to allow some privacy. The sides can be assembled in different configurations to fit your needs. Available with clear top option or Reflection Cozy Cube that includes interior shatterproof mirrors. Reversible cushion is 1" thick and wipes clean. Some assembly required.



Clear Acrylic Top Cozy Cube

Item #	Description	Product Dimensions	List Price
<b>Wood Top</b>			
5-1335356-670	Cozy Cube	29-1/2 Wx29-1/2 Dx29-1/2 H in	\$409.95
5-2088370-670	Cozy Cube with Cushion	29-1/2 Wx29-1/2 Dx29-1/2 H in	\$490.95
5-1491056-670	Reflection Cozy Cube	29-1/2 Wx29-1/2 Dx29-1/2 H in	\$692.95
<b>Acrylic Top</b>			
5-2039674-670	Clear Acrylic Top Cozy Cube	29-1/2 Wx29-1/2 Dx29-1/2 H in	\$583.95
<b>Cushion</b>			
5-2088682-670	Cushion Only	28 L x 28 W x 1 H in	\$105.95



**Abilitations®**

**Abilitations® Seasons Cozy Shades**

Add a touch of seasonal flair every day of the year with these new designs! Cozy shades filter out annoying hues from fluorescent bulbs, softening the light for a "cozier" space. Designed for standard fluorescent fixtures. Each pack includes 4 flame-retardant 54"L x 24"W panels. Six magnets allow for single or double swags on each fixture.

Item #	Description	Product Dimensions	Color	Quantity	List Price
9-1571585-670	Winter	54 L x 24 W in	Multi-Color	Pack of 4	\$69.99
9-1571584-670	Fall	54 L x 24 W in	Multi-Color	Pack of 4	\$69.99
9-1571582-670	Spring	54 L x 24 W in	Multi-Color	Pack of 4	\$69.99
9-1571583-670	Summer	54 L x 24 W in	Multi-Color	Pack of 4	\$69.99





### Rifton® Compass Chair

The Compass Chair from Rifton® is the perfect inclusion chair for children and adults with mild disabilities. This classroom chair with high armrests helps users with poor upper trunk muscle control maintain their posture, the raised sides offer lateral hip support and the ergonomic shape of the seat and back promotes good sitting posture. Together these features provide sensory boundaries. For additional support and security, optional seat belts and stability feet are available separately.

Item #	Description	Product Dimensions	Quantity	List Price
6-2038938-670	Compass Chair Size 1	10-1/2 W x 9-1/2 D x 36 H in	Each	\$734.39
6-2038936-670	Compass Chair Size 2	12-1/4 W x 11 D x 43 H in	Each	\$803.79
6-2038939-670	Compass Chair Size 3	14 W 12-3/4 D x 48 H in	Each	\$859.69
6-2038940-670	Compass Chair Size 4	16-1/4 W 14-3/4 D x 55 H in	Each	\$923.19
6-2038937-670	Compass Chair Size 5	18-1/4 W 16-1/2 D x 63 H in	Each	\$1,129.09
9-2038935-670	Seatbelt Size 1 & 2	30 L x 1-1/2 W in	Each	\$102.29
9-2038933-670	Seatbelt Size 3	34 L x 1-1/2 W in	Each	\$102.29
9-2038934-670	Seatbelt Size 4 & 5	42 L x 1-1/2 W in	Each	\$102.29
9-2038932-670	Stability Feet	2 W x 2 D x 2 H in	Each	\$147.09



### Copernicus Self Regulation Classroom Cruiser

The new Self-regulation Classroom Cruiser is designed to provide opportunities for students, grades PreK-6, to self-regulate through movement without having to leave or disrupt the class. It is ideal for inclusive environments or in the home. The Cruiser helps kinesthetic learners and any student who needs to get the wiggles out so they can refocus and engage in learning.

Item #	Description	List Price
6-2028714-670	PREK-2 w/o Desktop	\$1,084.95
6-2028711-670	PREK-2 with Desktop	\$1,208.95
6-2028712-670	3-6 w/o Desktop	\$1,084.95
6-2028713-670	3-6 with Desktop	\$1,208.95

### Bouncybands®

Bouncybands® help students wiggle while they work! By resting and bouncing feet while sitting, the user can release extra energy and anxiety, increase focus and be more productive. The heavy-duty bands stretch between chair legs 13"-18"W and table legs 20"-28"W to help children, teens and adults fidget without distracting others. Bands made for Middle School and High School chairs stretch between chair legs 17"-24"W. The super strong plastic support pipes are the perfect height (4"H for chairs and 8"H for tables) and keep the bands from sliding down to the floor.



Item #	Description	Age Range	Quantity	List Price
9-2018456-670	Elementary Chair	3+ years	Each	\$24.09
9-2018455-670	Middle/HS Chair	8+ years	Each	\$30.99
9-2018457-670	Desks	5+ years	Each	\$25.99

## Abilitations®

### Abilitations® Footrest

The Abilitations® Footrest is designed to anchor to any standard elementary school-sized chair. It allows a student to sit with proper posture. The footrest works as a great sensory input for students, as they get to have both feet on a flat solid surface. Features two strips of adhesive tape, and non-slip bottom.



Item #	Description	Product Dimensions	Quantity	List Price
9-1603393-670	Foot Rest	11-3/4 L x 18 W x 4 H in	Each	\$252.79
9-1603394-670	Foot Rest	11-3/4 L x 20 W x 4 H in	Each	\$257.89

### Abilitations® 12 Inch CoreDisk™

This inflatable CoreDisk™ cushion can be sat on or stood upon. The disk can be used to provide stability for positioning, or active, free-flowing instability for the development of balance skills and trunk strength. Adjust inflation levels for more or less stability as desired using a standard athletic pump (sold separately). 12 in diameter. ▲CHOKING HAZARD(1). Not for under 3yrs.



### Clear Squellet-Filled

Item #	Description	Product Dimensions	Color	Quantity	List Price
9-016909-670	Yellow Bead-Filled	12 in dia	Yellow	Each	\$71.29
9-020505-670	Foam-Filled w/ Beads and Gel	12 in dia	Orange	Each	\$71.29
9-020908-670	Clear Squellet-Filled	12 in dia	Clear	Each	\$71.29
9-030556-670	Blue PVC Ball-Filled	12 in dia	Blue	Each	\$71.29

### Abilitations® SqUoosh™

The SqUoosh™ will position, cradle, and SQUEEZE your wiggly students in a just-right way. The playful shape is designed specifically to squeeze into the child when sitting on it, providing a gentle, calming proprioceptive "hug" to help their systems organize. Made of high quality polyurethane foam and a surface washable vinyl cover. Recommended age range up to 8 years, or 70 pounds.



Item #	Description	Product Dimensions	Quantity	List Price
9-1452973-654	SqUoosh Chair	29 L x 13 W x 27-1/2 H in	Each	\$457.99

▲ Cautionary Warnings. See Page 8.



# The best choice for early childhood starts with C

..... The 5Cs of .....

## CHILDCRAFT®

When you see the Childcraft name on a product, it's more than just a brand. It's a promise—our commitment to you that everything we make meets our highest standards and a rigorous set of criteria we call the 5Cs.

### **C**hild-safe

Held to our highest safety standard

### **C**rafted with Quality

75 year heritage of top-quality manufacturing

### **C**onstructed for Durability

Backed by a limited lifetime warranty

### **C**omplete Solutions

For every area of a learning environment

### **C**leanable

Every surface can be wiped down easily

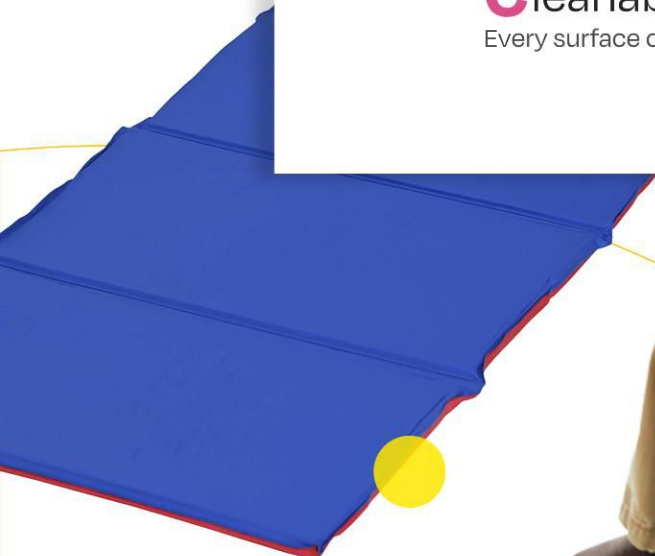

# CHILDCRAFT®

## KidSpaces™

# Early Childhood Classroom Packages



## One source, one price, extra savings for a complete classroom package!

### Easy Ordering

Enjoy ONE price\* for an entire classroom package of developmentally appropriate Childcraft® furnishings and learning materials... hand-selected by our Early Childhood experts based on best practices that support early learning standards.

### Free Shipping & Easy Classroom Set Up

Every order includes free lift gate and inside delivery! Or take advantage of our "White Glove Plus Service"\*\*\* that utilizes School Specialty's Certified installers. This no-cost option includes lift gate and inside delivery PLUS furniture assembly, set up and debris removal.

**For help with order quantities of 5 or more, or for any additional information please contact your School Specialty representative.**

Call **888-388-3224**

Web [Select.SchoolSpecialty.com/kidspaces](http://Select.SchoolSpecialty.com/kidspaces)



\* Price is subject to change.

\*\* Restrictions apply. White Glove Service is subject to installer scheduling and availability, which may require a longer lead time. Please note "White Glove" when placing your order.

### KidSpaces™

Includes all furnishings needed to create a PreK-3, PreK-4, or Kindergarten classroom.

#### PreK-3 Package

**\$15,999**

Item# 9N-2116257-670

#### PreK-4 Package

**\$17,499**

Item# 9N-2116258-670

#### Kindergarten Package

**\$14,999**

Item# 9N-2116255-670

### KidSpaces™ Plus

KidSpaces™ furniture package plus learning materials and supplies to create a PreK-3, PreK-4, or Kindergarten classroom.

#### PreK-3 Plus Package

**\$23,799**

Item# 9N-2116259-670

#### PreK-4 Plus Package

**\$25,499**

Item# 9N-2116254-670

#### Kindergarten Plus Package

**\$23,499**

Item# 9N-2116256-670



PRODUCT CERTIFIED FOR LOW CHEMICAL EMISSIONS: UL.COM/IGG UL 2818



2-Section



3-Section



Toddler 5-Section



5-Section



**Childcraft® Bench Coat Lockers**

Storage for children's personal items includes top and bottom cubbies, a bench for children to sit on, and aluminum hooks on both sides of each locker section. Storage trays sold separately. **For maximum stability, lockers must be secured to the wall. Hardware and instructions included. Not recommended as a room divider.** Assembled.

Item #	Description	Product Dimensions	Number of Hooks	List Price
6-1301428-670	2 Section	21-7/8 W x 14-1/4 D x 48 H in	4	\$449.95
6-1403214-670	3 Section	32-1/2 W x 14-1/4 D x 48 H in	6	\$549.95
6-1464160-670	Toddler 5 Section	53-3/4 W x 14-1/4 D x 36 H in	10	\$678.95
6-202818-670	5 Section	53-3/4 W x 14-1/4 D x 48 H in	10	\$714.95



**Childcraft® Value Coat Locker**

Basic locker constructed of all-birch panels includes bottom cubbies each measuring 10"W x 9"D x 8-3/8"H and aluminum hooks on both sides of each locker section. **For maximum stability, locker must be secured to the wall. Hardware and instructions included. Not recommended as a room divider.** Assembled.

Item #	Description	Product Dimensions	Number of Hooks	List Price
6-271555-670	5 Section	53-3/4 W x 9-5/8 D x 42 H in	10	\$642.95



**Childcraft® Straight-Sided Coat Locker**

Locker with two aluminum hooks in each section includes upper and lower compartments for additional storage. Provides space for up to 10 students. Storage trays sold separately. **For maximum stability, locker must be secured to the wall. Hardware and instructions included. Not recommended as a room divider.** Assembled.

Item #	Description	Product Dimensions	Number of Hooks	List Price
6-272044-670	Straight Sided	53-3/4 W x 14-1/4 D x 48 H in	10	\$777.95



**Childcraft® Toddler 4-Section Bench Coat Locker**

Locker designed for toddlers features a bench seat and each locker section includes double aluminum hooks, nameplate, and shatterproof mirror. Storage trays sold separately. **For maximum stability, locker must be secured to the wall. Hardware and instructions included. Not recommended as a room divider.** Assembled.

Item #	Description	Product Dimensions	Number of Hooks	List Price
6-2039673-670	Toddler 4 Section	47-3/4 W x 14-1/4 D x 36 H in	8	\$944.95



**Childcraft® Narrow 8-Cubby Coat Locker**

This unit includes lockers with two staggered aluminum hooks in each section and eight upper cubbies that can house deep storage trays. Storage trays sold separately. **For maximum stability, locker must be secured to the wall. Hardware and instructions included. Not recommended as a room divider.** Assembled. Trays sold separately.

Item #	Description	Product Dimensions	Number of Hooks	List Price
6-1588153-670	8 Section	59-1/2 W x 14-1/4 D x 48 H in	16	\$1,395.95





PRODUCT CERTIFIED  
FOR LOW CHEMICAL  
EMISSIONS:  
UL.COM/IGG  
UL 2818



**CHILDCRAFT®**  
A School Specialty Exclusive

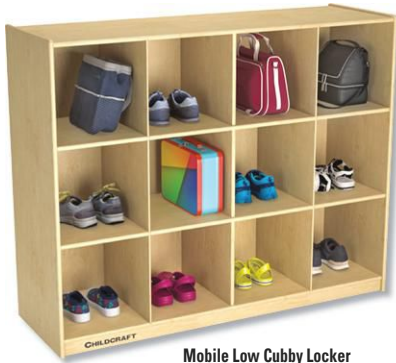

Mobile Low Cubby Locker



Mobile Cubby Locker

### Childcraft® 12-Section Mobile Cubby Locker

This mobile unit offers twelve cubbies for storing children's personal items and comes in two sizes. Heavy-duty casters. Assembled.

Item #	Description	Product Dimensions	Cubby Opening Size	List Price
6-1464173-670	Mobile Low Cubby Locker	51-1/2 W x 16-7/8 D x 42 H in	12-3/4 W x 16-1/4 D x 12-5/16 H in	\$799.95
6-1448794-670	Mobile Cubby Locker	47-3/4 W x 15 D x 48 H in	15-1/8 W x 14-5/8 D x 10-9/16 H in	\$799.95



1 Modular Coat Locker



5 Modular Coat Lockers  
Shown Bolted Together

### Childcraft® Modular Coat Lockers

Features a soft-closing door, aluminum hooks, and top and bottom compartments for storage. **For maximum stability, locker must be secured to the wall. Hardware and instructions included. Not recommended as a room divider.** Single unit is assembled; set of 5 needs to be bolted together.

Item #	Description	Product Dimensions	Number of Hooks	List Price
6-1544986-670	Single Unit	10-9/16 W x 15 D x 50 H in	3	\$394.95
6-1568772-670	Set of 5 Lockers	10-9/16 W x 15 D x 50 H in	15	\$1,679.95



Double-Tub Locker with  
10 Primary Color Trays

### Childcraft® Double-Tub Coat Lockers

Lockers include top and bottom cubbies, and main storage sections with two aluminum hooks in each, providing space for up to 10 students. **For maximum stability, locker must be secured to the wall. Hardware and instructions included. Not recommended as a room divider.** Assembled.

Item #	Description	Product Dimensions	Number of Hooks	List Price
6-272113-670	Double Tub	53-3/4 W x 14-1/4 D x 48 H in	10	\$1,037.95
6-204547-670	With Assorted Color Trays	53-3/4 W x 14-1/4 D x 48 H in	10	\$1,129.95



### Childcraft® Low Storage Unit

This unit offers twelve large cubbies for storing children's personal items. Assembled.

Item #	Product Dimensions	Cubby Opening Size	List Price
6-271591-670	58-3/8 W x 14-1/4 D x 30 H in	9-1/4 W x 13-5/8 D x 14-1/2 H in	\$827.95



### Childcraft® 5-Section Stacking/Locking Storage Locker

Lockers are designed to stack with each keyed individually plus a master key. **For maximum stability, lockers must be secured to the wall when stacked. Hardware and instructions included.** Assembled.

Item #	Product Dimensions	Cubby Opening Size	List Price
6-204154-670	59-1/2 W x 14-1/2 D x 23-3/4 H in	11-1/8 W x 13-1/8 D x 20-1/2 H in	\$1,192.95



PRODUCT CERTIFIED FOR LOW CHEMICAL EMISSIONS: UL.COM/IGG UL 2818



**Childcraft® 12-Section Coat Locker**

The perfect storage option when locker space is at a premium. Each compartment has two aluminum hooks. **For maximum stability, locker must be secured to the wall or floor. Hardware and instructions included. Not recommended as a room divider.** Assembled.

Item #	Description	Product Dimensions	Number of Hooks	List Price
6-1301430-670	12 Section	53-3/4 W x 14-1/4 D x 48 H in	24	\$1,181.95



**Childcraft® Wall Coat Locker With Shelf**

Wall-mounted shelf has two aluminum hooks in each lower section. Wall-mounting hardware and instructions included. Assembled.

Item #	Description	Product Dimensions	Number of Hooks	List Price
5-1459813-670	Wall Coat Locker With Shelf	47-3/4 Wx7-3/4 Dx7-3/4 H in	10	\$333.95



**Childcraft® 10-Cubby Wall Mounted Locker**

Wall-mounted unit has upper cubbies and two aluminum hooks in each lower section. Available with or without storage trays or baskets. Wall-mounting hardware and instructions included. Assembled.

Item #	Description	Product Dimensions	Number of Hooks	List Price
6-1464167-670	10 Cubby	47-3/4 Wx14-1/4 Dx19-3/4 H in	10	\$561.95
6-2019871-670	With Translucent Color Trays	47-3/4 Wx14-1/4 Dx19-3/4 H in	10	\$653.95
6-1473440-670	With Primary Color Trays	47-3/4 Wx14-1/4 Dx19-3/4 H in	10	\$653.95
6-1537081-670	With Clear Trays	47-3/4 Wx14-1/4 Dx19-3/4 H in	10	\$653.95
6-1473441-670	With Small Baskets	47-3/4 Wx14-1/4 Dx19-3/4 H in	10	\$807.95



4 HOOKS



7 HOOKS



8 HOOKS

**Childcraft® Coat Rack Wall Mount Strip**

Coat rack built with aluminum double hooks mounted on 11-ply birch panel. Wall-mounting hardware and instructions included.

Item #	Description	Product Dimensions	Number of Hooks	List Price
5-2020854-670	Wall Coat Strip	29-3/4 W x 1-7/8 D x 4 H in	4	\$85.95
5-271615-670	Wall Coat Strip	47-15/16 W x 1-7/8 D x 4 H in	7	\$136.95
5-2020855-670	Wall Coat Strip	59-1/2 W x 1-7/8 D x 4 H in	8	\$166.95



**Childcraft® Mobile Backpack Cart**

Mobile backpack storage cart includes 28 aluminum hooks and extra storage on top and bottom. Easily fits through standard doorways. Heavy-duty locking casters. Assembled.

Item #	Description	Product Dimensions	Number of Hooks	List Price
6-2020821-670	Backpack Cart	49-3/4 W x 26-1/2 D x 49 H in	28	\$1,374.95





PRODUCT CERTIFIED FOR LOW CHEMICAL EMISSIONS: UL.COM/IGG UL 2818



**CHILDCRAFT®**  
A School Specialty Exclusive



10 Cubby Unit with Translucent Trays



Toddler 12 Cubby Unit with Primary Color Trays



20 Cubby Unit with Clear Trays



16 Cubby Unit with Wicker Baskets



25 Cubby Unit with Translucent Trays



30 Cubby Unit with Primary Color Trays

**Childcraft® Mobile Cubby Units**

Removable shelves let you configure each unit with flexible storage options and easy cleaning. Heavy-duty casters. Holds trays sized 7-7/8"W x 12-1/4"D x 5-3/8"H. Assembled.

Item #	Description	List Price
<b>10-Cubby Unit - 19-1/2" W x 14-1/4" D x 36" H in</b>		
5-299366-670	Cubby	\$620.95
5-2019872-670	With Translucent Color Trays	\$712.95
5-070043-670	With Primary Color Trays	\$712.95
5-265233-670	With Clear Trays	\$712.95
5-1440377-670	With Wicker Baskets	\$866.95
<b>Toddler 12-Cubby Unit - 38-3/4" W x 14-1/4" D x 24" H in</b>		
5-1429287-670	Toddler Cubby	\$657.95
5-2019884-670	With Translucent Color Trays	\$768.95
5-1444400-670	With Primary Color Trays	\$768.95
5-1444399-670	With Clear Trays	\$768.95
5-1444398-670	With Small Baskets	\$952.95
<b>16-Cubby Unit - 38-3/4" W x 14-1/4" D x 30" H in</b>		
6-267014-670	Cubby	\$738.95
6-2019874-670	With Translucent Color Trays	\$886.95
6-296573-670	With Primary Color Trays	\$886.95
6-675309-670	With Clear Trays	\$886.95
6-1440343-670	With Small Baskets	\$1,131.95
<b>20-Cubby Unit - 47-3/4" W x 14-1/4" D x 30" H in</b>		
6-306444-670	Cubby	\$757.95
6-2019878-670	With Translucent Color Trays	\$941.95
6-296216-670	With Primary Color Trays	\$941.95
6-296159-670	With Clear Trays	\$941.95
6-1440347-670	With Small Baskets	\$1,249.95
<b>25-Cubby Unit - 47-3/4" W x 14-1/4" D x 36" H in</b>		
6-271552-670	Cubby	\$842.95
6-2019873-670	With Translucent Color Trays	\$1,072.95
6-296219-670	With Primary Color Trays	\$1,072.95
6-296153-670	With Clear Trays	\$1,072.95
6-1440345-670	With Small Baskets	\$1,456.95
<b>30-Cubby Unit - 47-3/4" W x 14-1/4" D x 42" H in</b>		
6-075042-670	Cubby	\$1,219.95
6-2019877-670	With Translucent Color Trays	\$1,495.95
6-296564-670	With Primary Color Trays	\$1,495.95
6-296570-670	With Clear Trays	\$1,495.95
6-1440342-670	With Small Baskets	\$1,956.95





PRODUCT CERTIFIED FOR LOW CHEMICAL EMISSIONS  
UL.COM/GG  
UL 2818



10 Cubby Unit with Clear Trays



25 Cubby Unit with Primary Color Trays



25 Cubby Unit with Translucent Color Trays

### Childcraft® Mobile Cubby Units with Locking Casters

Removable dividers provide flexible storage options by allowing you to configure the units the way you need them. Holds trays or baskets sized up to 7-7/8"W x 12-1/4"D x 5-3/8"H. Features dual-wheel locking casters. Assembled.

Item #	Description	List Price
<b>10-Cubby Unit - 19-3/4" W x 14-1/4" D x 36" H in</b>		
5-1559875-670	Cubby	\$622.95
5-2019880-670	With Translucent Color Trays	\$714.95
5-1568736-670	With Primary Color Trays	\$714.95
5-1568737-670	With Clear Trays	\$714.95
5-1568738-670	With Wicker Baskets	\$868.95
<b>25-Cubby Unit - 47-3/4" W x 14-1/4" D x 36" H in</b>		
6-1559880-670	Cubby	\$843.95
6-2019881-670	With Translucent Color Trays	\$1,073.95
6-1568742-670	With Primary Color Trays	\$1,073.95
6-1568743-670	With Clear Trays	\$1,073.95
6-1568744-670	With Baskets	\$1,457.95

### Childcraft® Mobile 12-Tray and 2-Shelf Storage

Room for 12 small trays or baskets sized 7-7/8"W x 12-1/4"D x 5-3/8"H, plus two open shelves that can hold 4 medium trays or baskets sized 11"W x 16"D x 6"H. Removable shelves offer flexible storage options. Heavy-duty casters. Assembled.

Item #	Description	List Price
<b>12-Tray and 2-Shelf Storage - 47-3/4" W x 14-1/4" D x 30" H in</b>		
6-267035-670	Mobile 12-Tray 2-Shelf Unit	\$999.95
6-2019885-670	w/12 Trans Color/4 Translucent	\$1,183.95
6-296558-670	w/12 Asstd Color/4 Translucent	\$1,183.95
6-675321-670	w/12 Sm Clear/4 Translucent	\$1,183.95



With 12 Primary Color Trays and 4 Medium Translucent Trays with Lids



With 16 Deep Clear Trays

### Childcraft® Mobile Flex Cubby

This versatile unit can hold up to 20 small cubby trays, sized 7-7/8"W x 12-1/4"D x 5-3/8"H, or 16 of our deep storage trays, sized 10-3/4"W x 13-3/8"D x 5-1/4"H, or combinations of both. Removable dividers allow you to configure each shelf the way you want it. Heavy-duty casters. Assembled.

Item #	Description	List Price
<b>Mobile Flex Cubby - 47-3/4" W x 14-1/4" D x 30" H in</b>		
6-206046-670	Mobile Flex Cubby	\$1,013.95
6-206050-670	w/10Std/8DpFlat AsstColorTrays	\$1,233.95
6-206044-670	w/10 Std/8 DeepFlat ClearTrays	\$1,233.95
6-206056-670	w/16 AsstColor Deep Flat Trays	\$1,233.95
6-206052-670	w/16 Clear Deep Flat Trays	\$1,233.95



With 10 Primary Color Trays and 8 Deep Primary Color Trays



PRODUCT CERTIFIED FOR LOW CHEMICAL EMISSIONS: UL.COM/IGG UL 2818



24 Tray Cubby with Primary Color Trays



24 Tray Cubby with Translucent Trays



30 Tray Cubby with Primary Color Trays

### Childcraft® Mobile Flat-Tray Cubby

Removable shelves let you configure each shelf for flexible storage options and easy cleaning. Holds Flat Storage Trays sized 10-3/4"W x 13-1/4"D x 3"H. Heavy-duty casters. Assembled.

Item #	Description	List Price
<b>24-Flat-Tray Cubby - 47-3/4 W x 14-1/4 D x 30 H in</b>		
6-075060-670	24-Flat-Tray Cubby	\$986.95
6-296735-670	With Primary Color Trays	\$1,399.95
6-296732-670	With Translucent Trays	\$1,399.95
<b>30-Flat-Tray Cubby - 58-3/4 W x 14-1/4 D x 30 H in</b>		
6-272116-670	30-Flat-Tray Cubby	\$1,232.95
6-296927-670	With Primary Color Trays	\$1,748.95
6-296930-670	With Translucent Trays	\$1,748.95

### Childcraft® Mobile 24 Flat-Tray Cubby With Locking Casters

Removable dividers let you configure each shelf for flexible storage options and easy cleaning. Cubby is also available with 24 Flat Storage Trays sized 10-3/4"W x 13-1/4"D x 3"H. Heavy-duty locking casters. Assembled.



With Translucent Trays

Item #	Description	List Price
<b>24-Flat-Tray Cubby - 47-3/4 W x 14-1/4 D x 30 H in</b>		
6-1559885-670	24-Flat-Tray Cubby	\$986.95
6-1568748-670	With Primary Color Trays	\$1,399.95
6-1568749-670	With Translucent Trays	\$1,399.95



With Primary Color Trays

### Childcraft® Mobile 24-Tray Cubby

Removable shelves let you configure each unit with flexible storage options and easy cleaning. Available with trays sized 11"W x 16"D x 6"H. Heavy-duty casters. Assembled.

Item #	Description	List Price
<b>24-Tray Cubby - 50 W x 16-3/4 D x 42 H in</b>		
6-2020866-670	Cubby	\$1,153.95
6-2024111-670	With Primary Color Trays	\$1,595.95
6-2024112-670	With Translucent Trays	\$1,595.95

### Childcraft® Mobile Big-Tub Cubby Units

Perfect storage for larger items. Removable shelves provide flexible storage options and easy cleaning. Holds tubs sized 11-3/4"W x 15-1/2"D x 7-1/2"H. Heavy-duty casters. Assembled.

Item #	Description	List Price
<b>12-Big-Tub Cubby - 38-1/2 W x 16 D x 36 H in</b>		
6-271663-670	12-Big-Tub Cubby	\$794.95
6-1540096-670	With Primary Color Tubs/Lids	\$1,118.95
6-265335-670	With Translucent Tubs/Lids	\$1,118.95
<b>16-Big-Tub-Cubby - 50-3/4 W x 16 D x 36 H in</b>		
6-272059-670	16-Big-Tub Cubby	\$903.95
6-1540097-670	With Primary Color Tubs/Lids	\$1,335.95
6-1468538-670	With Translucent Tubs/Lids	\$1,335.95



12 Big Tub Cubby with Translucent Trays



16 Big Tub Cubby with Primary Color Trays





**NEW**

**Childcraft® Mobile Flat-Tray and Folder Cubby**

Store homework and paperwork all in one place for easy organization. Twenty vertical slots to fit folders and 20 flat-tray cubbies for personal belongings.

Item #	Description	List Price
<b>Flat-Tray and Folder Cubby - 47-3/4" W x 14-1/4" D x 36 H in</b>		
6-2092029-670	Flat-Tray and Folder Cubby	\$996.95
6-2092046-670	With Translucent Trays	\$1,340.95
6-2092041-670	With Primary Color Trays	\$1,340.95



With Translucent Trays



With Primary Color Trays

**Childcraft® Mobile Folder and Tray Cubby**

Roomy vertical slots hold materials up to 9" x 12". Removable shelves and dividers let you configure the shelves the way you need them for flexible storage. Holds up to 20 small trays or baskets sized 7-7/8"W x 12-1/4"D x 5-3/8"H. Heavy-duty casters. Assembled.

Item #	Description	List Price
<b>Folder and Tray Cubby - 47-3/4" W x 14-1/4" D x 42 H in</b>		
6-272077-670	Folder and Tray Cubby	\$1,294.95
6-2019888-670	With Translucent Color Trays	\$1,478.95
6-296906-670	With Primary Color Trays	\$1,478.95
6-1577199-670	With Clear Trays	\$1,478.95
6-1440346-670	With Small Baskets	\$1,786.95

**Childcraft® Mobile Small-Tray Store-n-Stack**

Store a wide variety of supplies in this versatile unit. Shelves and dividers are removable, providing even more flexible storage options. Holds up to 15 small trays or baskets sized 7-7/8"W x 12-1/4"D x 5-3/8"H. Heavy-duty casters. Assembled.

Item #	Description	List Price
<b>Small-Tray Store-n-Stack - 47-3/4" W x 14-1/4" D x 36 H in</b>		
6-074508-670	Small-Tray Store-N-Stack	\$980.95
6-2019883-670	With Translucent Color Trays	\$1,118.95
6-296204-670	With Primary Color Trays	\$1,118.95
6-072174-670	With Clear Trays	\$1,118.95
6-1440341-670	With Small Baskets	\$1,349.95



With Translucent Color Trays

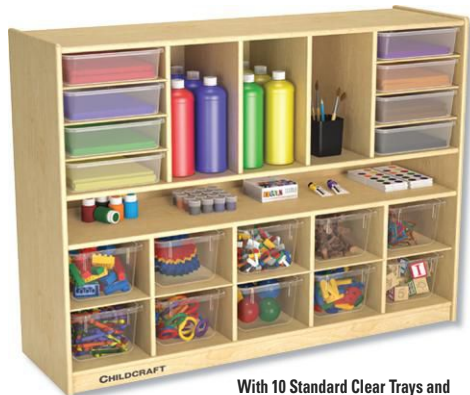

With 10 Standard Clear Trays and 8 Flat Translucent Trays

**Childcraft® Mobile Multi-Compartment Storage Cubby Unit**

Stay organized with this multi-compartment cubby unit. Removable dividers let you configure each shelf for flexible storage options. Top cubbies can hold 8 flat trays sized 10-3/4"W x 13-1/4"D x 3"H. Bottom cubbies can hold 10 trays sized 7-7/8"W x 12-1/4"D x 5-3/8"H. Heavy-duty casters. Assembled.

Item #	Description	List Price
<b>Multi-Compartment Storage Cubby - 47-3/4" W x 14-1/4" D x 36 H in</b>		
6-2039677-670	Multi-Compartment Storage	\$980.95
6-2048163-670	w/10Std/8Flat AsstdColor Trays	\$1,210.95
6-2048160-670	w/10Std/8Flat TranslucentTrays	\$1,210.95





Storage trays are compatible with most Childcraft® storage units.



**Storage Trays and Lids - Translucent Colors**

Updated Translucent Fashion Colors! Translucent for easier viewing of contents. Great for any use in the classroom. Strong and tough. Great for organizing classrooms, nurseries, daycare, dorms, offices and more. Stackable and durable. Lids sold separately.

Item #	Product Dimensions	Color	Quantity	List Price
<b>Storage Trays</b>				
9-2005882-670	7-7/8 x 12-1/4 x 5-3/8 in	Violet	Each	\$10.69
9-2005881-670	7-7/8 x 12-1/4 x 5-3/8 in	Teal	Each	\$10.69
9-2005889-670	7-7/8 x 12-1/4 x 5-3/8 in	Green	Each	\$10.69
9-2005888-670	7-7/8 x 12-1/4 x 5-3/8 in	Yellow	Each	\$10.69
9-2005880-670	7-7/8 x 12-1/4 x 5-3/8 in	Orange	Each	\$10.69
9-2005883-670	7-7/8 x 12-1/4 x 5-3/8 in	Red	Each	\$10.69
<b>Lids</b>				
9-081970-670	8 x 12-3/8 in	Translucent	Each	\$5.99
9-2051378-670	8 x 12-3/8 in	Clear	Each	\$9.29

**Flat Storage Trays**

These deep storage trays are designed to neatly organize all your letter-sized handouts, booklets, and papers, yet deep enough to hold small items. The bright colors are ideal for STEM or STEAM organization. The easy-to-grip comfort edges are a perfect fit for big and small hands. Made of nonporous plastic, these trays are dishwasher safe. Translucent lids sold separately.

Item #	Product Dimensions	Color	Quantity	List Price
<b>Flat Storage Trays</b>				
9-2019912-670	10-3/4 x 13-1/4 x 3 in	Black	Each	\$18.69
9-2019920-670	10-3/4 x 13-1/4 x 3 in	Blue	Each	\$18.69
9-2019919-670	10-3/4 x 13-1/4 x 3 in	Green	Each	\$18.69
9-2019917-670	10-3/4 x 13-1/4 x 3 in	Red	Each	\$18.69
9-2019908-670	10-3/4 x 13-1/4 x 3 in	Teal	Each	\$18.69
9-2019914-670	10-3/4 x 13-1/4 x 3 in	Violet	Each	\$18.69
9-2019907-670	10-3/4 x 13-1/4 x 3 in	Yellow	Each	\$18.69
9-2023531-670	10-3/4 x 13-1/4 x 3 in	White	Each	\$18.69
9-2023878-670	10-3/4 x 13-1/4 x 3 in	Translucent	Each	\$18.69
<b>Lids</b>				
9-2019921-670	10-7/8 x 13-1/4 in	Translucent	Each	\$6.69



**Storage Trays & Lids - Primary Colors**

Great for any use in the classroom. Strong tough tote will last and last. Our snap-on lid will top off our super tote. (Lids sold separately.) **Assorted Set of 5 includes:** Green, White, Blue, Yellow, and Red.

Item #	Product Dimensions	Color	Quantity	List Price
<b>Storage Trays</b>				
9-081941-670	7-7/8 x 12-1/4 x 5-3/8 in	Blue	Each	\$9.99
9-081949-670	7-7/8 x 12-1/4 x 5-3/8 in	White	Each	\$9.99
9-081965-670	7-7/8 x 12-1/4 x 5-3/8 in	Green	Each	\$9.99
9-081967-670	7-7/8 x 12-1/4 x 5-3/8 in	Translucent	Each	\$9.99
9-081943-670	7-7/8 x 12-1/4 x 5-3/8 in	Yellow	Each	\$9.99
9-081947-670	7-7/8 x 12-1/4 x 5-3/8 in	Red	Each	\$9.99
9-279061-670	7-7/8 x 12-1/4 x 5-3/8 in	Clear	Each	\$13.99
<b>Pack of 5</b>				
9-1594736-670	7-7/8 x 12-1/4 x 5-3/8 in	Blue	Pack of 5	\$46.69
9-1594739-670	7-7/8 x 12-1/4 x 5-3/8 in	White	Pack of 5	\$46.69
9-1594740-670	7-7/8 x 12-1/4 x 5-3/8 in	Green	Pack of 5	\$46.69
9-1594741-670	7-7/8 x 12-1/4 x 5-3/8 in	Translucent	Pack of 5	\$46.69
9-1594737-670	7-7/8 x 12-1/4 x 5-3/8 in	Yellow	Pack of 5	\$46.69
9-1594738-670	7-7/8 x 12-1/4 x 5-3/8 in	Red	Pack of 5	\$46.69
9-1594746-670	7-7/8 x 12-1/4 x 5-3/8 in	Slate	Pack of 5	\$46.69
9-1595134-670	7-7/8 x 12-1/4 x 5-3/8 in	Assorted	Pack of 5	\$46.69
9-1594749-670	7-7/8 x 12-1/4 x 5-3/8 in	Clear	Pack of 5	\$54.69
<b>Lids</b>				
9-081970-670	8 x 12-3/8 in	Translucent	Each	\$5.99
9-2051378-670	8 x 12-3/8 in	Clear	Each	\$9.29
9-1594742-670	8 x 12-3/8 in	Translucent	Pack of 5	\$26.69
9-2051376-670	8 x 12-3/8 in	Clear	Pack of 5	\$46.69



**Deep Storage Trays**

These deep storage trays are designed to neatly organize all your letter-sized handouts, booklets, and papers, yet deep enough to hold a variety of small items. The bright colors are ideal for STEM or STEAM organization. The easy-to-grip comfort edges are perfectly sized for big and small hands. Made of nonporous plastic, these trays are dishwasher safe and drop resistant. The translucent lids sold separately make these trays stackable and protect their contents.

Item #	Product Dimensions	Color	Quantity	List Price
<b>Deep Storage Trays</b>				
9-2019911-670	10-3/4 x 13-3/8 x 5-1/4 in	Blue	Each	\$17.29
9-2019918-670	10-3/4 x 13-3/8 x 5-1/4 in	Green	Each	\$17.29
9-2019909-670	10-3/4 x 13-3/8 x 5-1/4 in	Red	Each	\$17.29
9-2019913-670	10-3/4 x 13-3/8 x 5-1/4 in	Violet	Each	\$17.29
9-2019915-670	10-3/4 x 13-3/8 x 5-1/4 in	Yellow	Each	\$17.29
9-2023877-670	10-3/4 x 13-3/8 x 5-1/4 in	Translucent	Each	\$17.29
<b>Lids</b>				
9-2019921-670	10-7/8 x 13-1/4 in	Translucent	Each	\$6.69



PRODUCT CERTIFIED FOR LOW CHEMICAL EMISSIONS: UL.COM/CGG UL 2818



All hide-aways fold together to secure your items and can be rolled away for storage.

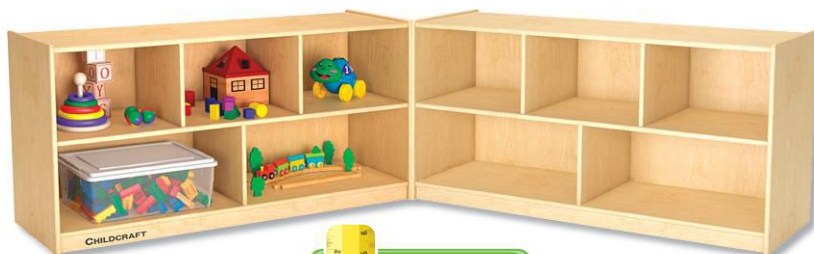

### Childcraft® Mobile Hide-Away Cabinet

Two sides provide lots of storage space that can be closed for security or space saving. Heavy-duty casters. Simple hinge and catch assembly required; hardware and instructions included. Each half measures 47-3/4"W x 14-1/4"D. Toddler Cabinet is 24" H and Preschool Cabinet is 30" H.

Item #	Description	List Price
<b>Hide-Away Cabinet - 95-1/2 W x 14-1/4 D x 24 H in</b>		
6-296057-670	Toddler Cabinet	\$991.95
<b>Hide-Away Cabinet - 95-1/2 W x 14-1/4 D x 30 H in</b>		
6-204426-670	Preschool Cabinet	\$1,026.95

### Childcraft® Mobile Super-Sized Hide-Away Cabinet

16 large storage compartments keep your materials neatly organized. Heavy-duty casters. Simple hinge and catch assembly required; hardware and instructions included. Each half measures 47-3/4"W x 14-1/4"D x 36"H. 172 lbs.

Item #	Description	List Price
<b>Super-Sized Hide-Away Cabinet - 95-1/2 W x 14-1/4 D x 36 H in</b>		
6-202824-670	Super-Sized Cabinet	\$1,444.95

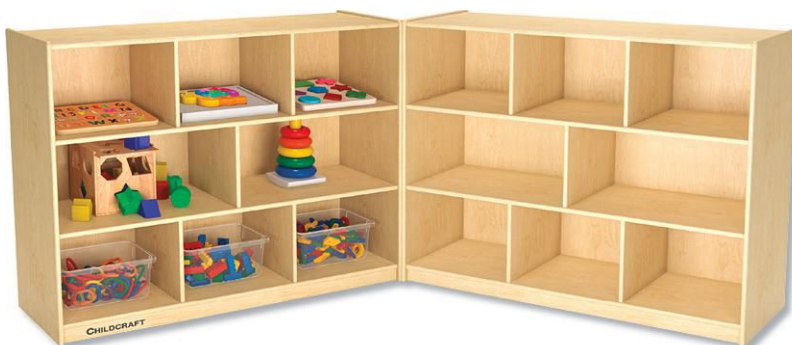

### Childcraft® Mobile 20-Tray Hide-Away Cabinet

Lots of storage space that can be locked up when not in use. One side has 3 compartments, while the other side has room for up to 20 trays or baskets sized 7-3/4"W x 12"D x 5-1/4"H. Simple hinge and catch assembly required; hardware and instructions included. Each half measures 47-3/4"W x 14-1/4"D x 30"H.

Item #	Description	List Price
<b>20-Tray Hide-Away Cabinet - 95-1/2 W x 14-1/4 D x 30 H in</b>		
6-1537346-670	Hide-Away Cabinet	\$1,372.95
6-2019882-670	With Translucent Color Trays	\$1,574.95
6-1537078-670	With Primary Color Trays	\$1,574.95
6-1537079-670	With Clear Trays	\$1,574.95



With Translucent Color Trays





PRODUCT CERTIFIED FOR LOW CHEMICAL EMISSIONS: UL CQM1GG UL 2818



**CHILDCRAFT®**  
A School Specialty Exclusive



Front with 12 Translucent Color Trays

**Childcraft® Mobile Double-Sided Storage Peninsula**

Front features 2 roomy shelves and removable cubby shelves that accommodates 12 standard storage trays. Back feature 3 long shelves. Easy to clean laminate top. Heavy-duty casters. Assembled.



Item #	Description	Reverse Side	List Price
<b>Double-Sided Storage Peninsula - 47-3/4 W x 23-3/4 D x 30 H in</b>			
6-074988-670	Mobile 2-Sided Storage Unit		\$953.95
6-2019886-670	With Translucent Color Trays		\$1,050.95
6-296528-670	With Primary Color Trays		\$1,050.95
6-296222-670	With Clear Trays		\$1,050.95



Front



Reverse Side

**Childcraft® Mobile Double-Sided Storage Unit**

Three-compartment storage on each side provides plenty of space for toys and supplies. Heavy-duty casters. Assembled.

Item #	Description	Product Dimensions	List Price
6-513575-670	Mobile 2-Sided Storage Unit	47-3/4 W x 22-1/4 D x 30 H in	\$834.95



**Childcraft® Toddler Rest-and-Read Storage Bench**

Toddler bench with 9" deep seat, backrest with upper storage bin behind it, and additional cubbies below. Available with or without washable baskets that include detachable plastic pouches for labeling materials. Assembled.

Item #	Description	Seat Height	List Price
<b>Storage Bench - 49 W x 17-3/4 D x 17 H in</b>			
5-1429288-670	Toddler Storage Bench	10 in	\$655.95
5-1444401-670	With 4 Small & 4 Med. Baskets	10 in	\$876.95



**Childcraft® Bench with Cushion**

Bench with five storage cubbies, each measuring 8-3/4"W x 14-1/8" D x 11"H, and 1" thick beige vinyl cushion. Assembled.

Item #	Description	Seat Height	List Price
<b>Bench with Cushion - 47-3/4 W x 14-3/4 D x 16 H in</b>			
5-1387319-670	Bench with Cushion	16 in	\$650.95
5-1469174-670	Replacement Cushion	1 in	\$153.95



**Childcraft® Rest and Storage Bench**

Bench with four see-through storage bins, each measuring 12-7/8" square x 10-1/2"H. Assembled.

Item #	Description	Seat Height	List Price
<b>Storage Bench - 55-5/8 W x 14-1/4 D x 14 H in</b>			
5-1428818-670	Rest and Storage Bench	14 in	\$1,053.95





**Childcraft® Mobile 3-Compartment Storage Unit**

This three-compartment storage unit is an essential for storing and organizing blocks, toys, supplies, and more. Heavy-duty casters. Assembled.

Item #	Description	Product Dimensions	List Price
6-1335358-670	Mobile 3-Compartment	47-3/4 W x 14-1/4 D x 30 H in	\$491.95



**Childcraft® 5-Compartment Storage Unit**

Five-compartment storage unit provides ample space for storing and organizing. Assembled.

Item #	Description	Product Dimensions	List Price
6-265251-670	5-Compartment	47-3/4 W x 11-5/8 D x 30 H in	\$471.95



Toddler Unit



**Childcraft® Mobile 5-Compartment Storage Unit**

Five-compartment storage holds toys, blocks, and other supplies, keeping them neat and accessible. Heavy-duty casters. Assembled.

Item #	Description	Product Dimensions	List Price
6-074531-670	Mobile Toddler 5-Compartment	47-3/4 W x 14-1/4 D x 24 H in	\$474.95
6-202815-670	Mobile 5-Compartment	47-3/4 W x 14-1/4 D x 30 H in	\$491.95



**Childcraft® Mobile 7-Compartment Storage Unit**

Seven-compartment unit allows for many storage options and makes organizing easy. Not recommended as a room divider. Hardware included for mounting to wall or floor. Assembled.

Item #	Description	Product Dimensions	List Price
6-202816-670	Mobile 7-Compartment	47-3/4 W x 14-1/4 D x 42 H in	\$838.95



**Childcraft® Mobile 8-Compartment Storage Unit**

Eight-compartment unit allows for many storage options and makes organizing easy. Heavy-duty casters. Assembled.

Item #	Description	Product Dimensions	List Price
6-1464170-670	Mobile 8-Compartment	47-3/4 W x 14-1/4 D x 36 H in	\$607.95



PRODUCT CERTIFIED FOR LOW CHEMICAL EMISSIONS: UL CONFGS UL 2818



24"H 3-Compartment Unit



30"H 5-Compartment Unit



36"H 7-Compartment Unit



Available in toddler height

### Childcraft® Mobile Compartment Storage Units with Locking Casters

Mobile compartment storage units hold toys, blocks, and other supplies, keeping them neat and accessible. Features dual-wheel locking casters. Assembled.

Item #	Description	Product Dimensions	List Price
6-1558435-670	Mobile 3-Compartment	47-3/4 W x 14-1/4 D x 24 H in	\$474.95
6-1558440-670	Mobile 5-Compartment	47-3/4 W x 14-1/4 D x 30 H in	\$491.95
6-1558441-670	Mobile 7-Compartment	47-3/4 W x 14-1/4 D x 36 H in	\$607.95



Block Bin with Block Labels & 100 Piece Block Set



Dry-Erase Back Panel

### Childcraft® Mobile Block Storage Bin

Stores blocks and encourages organizational, spatial, and cognitive skills for math development. Four lower and two upper compartments can fit up to 20 different sized blocks. Unit available with blue adhesive block labels or a 100-piece block set and corresponding blue adhesive block labels. Features dual-wheel locking casters. Assembled.

Item #	Description	Product Dimensions	List Price
5-2003901-670	Block Bin	35-3/4 W x 21-1/2 D x 31 H in	\$817.95
5-2006095-670	Block Bin with Blue Labels	35-3/4 W x 21-1/2 D x 31 H in	\$894.95
6-2006096-670	Bin w/ Blue Labels and Blocks	35-3/4 W x 21-1/2 D x 31 H in	\$1,300.95
<b>Adhesives</b>			
9-1572963-670	Adhesive Block Labels-Blue	-	\$85.95



Block cabinet with 260 Blocks and 25 Block Labels



Block Cabinet with End Pocket and Block Labels

### Childcraft® Mobile Block Cabinets and Packages

Stores blocks, encouraging organizational, spatial, and cognitive skills for math development. Features compartments for smaller and lighter blocks at the top and heavier blocks at the bottom. Also available with an end pocket to store those long/tall blocks. End pocket is now available as a separate option if needed for an existing unit. Other options include 25 blue adhesive block labels and a 260-piece block set. Features dual-wheel locking casters. Assembled.

Item #	Description	Product Dimensions	List Price
<b>Block Cabinet</b>			
5-205879-670	Block Storage Unit	36-1/2 W x 13 D x 24-7/8 H in	\$664.95
5-205881-670	Unit w/ Blue Labels	36-1/2 W x 13 D x 24-7/8 H in	\$741.95
6-1492065-670	Unit w/ Blue Labels and Blocks	36-1/2 W x 13 D x 24-7/8 H in	\$1,535.95
<b>Block Cabinet with End Pocket</b>			
5-2106999-670	Block Storage Unit w/ End Pkt	40-1/8 W x 13 D x 25-3/8 H in	\$774.95
5-1568767-670	Unit w/ Blue Labels	40-1/8 W x 13 D x 25-3/8 H in	\$851.95
6-1568768-670	Unit w/ Blue Labels and Blocks	40-1/8 W x 13 D x 25-3/8 H in	\$1,645.95
<b>End Pocket</b>			
5-2106739-670	Pocket Block Organizer <b>NEW</b>	13 W x 4-3/8 D x 21-1/2 H in	\$119.95
<b>Adhesives</b>			
9-1572963-670	Adhesive Block Labels-Blue	-	\$85.95



QUICKSHIP  
Items ship within 24 hrs, 48 hrs, 1 or 2 weeks as indicated when the factory distribution center receives the order.

Items ship **Freight** or **Parcel** See Shipping & Handling terms for details.





PRODUCT CERTIFIED FOR LOW CHEMICAL EMISSIONS: ULC QDW4GG UL 2818



24" H Unit



36" H Unit



42" H Unit



30" H Unit

### Childcraft® Mobile Open-Shelving Units with Locking Casters

Open-Shelving for maximum storage. Dual-wheel locking casters. 42" H unit not recommended as a room divider. Assembled.

Item #	Description	Product Dimensions	Number of Shelves	List Price
6-1301517-670	Mobile Open-Shelving Unit	47-3/4 W x 14-1/4 D x 24 H in	2	\$480.95
6-1301522-670	Mobile Open-Shelving Unit	47-3/4 W x 14-1/4 D x 30 H in	2	\$531.95
6-1301523-670	Mobile Open-Shelving Unit	47-3/4 W x 14-1/4 D x 36 H in	3	\$705.95
6-1301524-670	Mobile Open-Shelving Unit	47-3/4 W x 14-1/4 D x 42 H in	3	\$814.95

### Childcraft® Mobile Open Adjustable Shelving Units with Locking Casters

Mobile shelving unit with adjustable shelves. Dual-wheel locking casters. Assembled.

Item #	Description	Product Dimensions	Number of Shelves	List Price
5-1558444-670	Adjustable Shelf Unit	35-3/4 W x 14-1/4 D x 24 H in	2	\$459.95
6-1558449-670	Adjustable Shelf Unit	35-3/4 W x 14-1/4 D x 36 H in	3	\$596.95

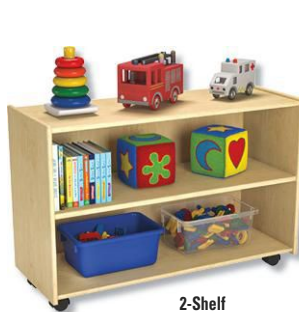

2-Shelf



3-Shelf



2-Shelf



3-Shelf



Dividers can be adjusted!

### Childcraft® Mobile Open Shelving Units with Adjustable Dividers and Locking Casters

Mobile shelving unit with adjustable shelves and sliding dividers. Dual-wheel locking casters. Assembled.

Item #	Description	Product Dimensions	Number of Shelves	List Price
6-1558438-670	Adjustable Divider Unit	47-3/4 W x 14-1/4 D x 30 H in	2	\$734.95
6-1558450-670	Adjustable Divider Unit	35-3/4 W x 14-1/4 D x 42 H in	3	\$734.95
9-1564567-670	Extra Dividers - Set of 4	12-1/2 W x 7 H in	-	\$92.95





PRODUCT CERTIFIED FOR LOW CHEMICAL EMISSIONS: UL 2818



3-Shelf



4-Shelf

### Childcraft® Shelf Storage Units

Sturdy open shelves provide generous storage space. Assembled.

Item #	Description	Product Dimensions	Number of Shelves	List Price
6-1464418-670	3-Shelf	35-3/4 W x 13 D x 36 H in	3	\$523.95
6-1464419-670	4-Shelf	35-3/4 W x 13 D x 48 H in	4	\$651.95



2-Shelf Storage Unit



3-Shelf Storage Unit



4-Shelf Storage Unit

### Childcraft® Deep Shelf Storage

Extra deep shelves to accommodate larger items. Assembled.

Item #	Description	Product Dimensions	Number of Shelves	List Price
5-1335360-670	2-Shelf Storage Unit	35-3/4 W x 14-3/4 D x 24 H in	2	\$411.95
6-1335361-670	3-Shelf Storage Unit	35-3/4 W x 14-3/4 D x 36 H in	3	\$530.95
6-1335362-670	4-Shelf Storage Unit	35-3/4 W x 14-3/4 D x 48 H in	4	\$656.95



30" Mobile Bookcase with Lip



36" Mobile Bookcase with Lip



36" Mobile Bookcase with No Lip

### Childcraft® Adjustable Mobile Bookcases

Mobile bookcase with adjustable shelves. Units with lip allow for display room on top. Heavy-duty casters. Assembled.

Item #	Description	Product Dimensions	Number of Shelves	List Price
6-1464171-670	Mobile Bookcase with Lip	47-3/4 W x 14-1/4 D x 30 H in	2	\$713.95
6-1464172-670	Mobile Bookcase with Lip	47-3/4 W x 14-1/4 D x 36 H in	3	\$927.95
6-1464415-670	Mobile Bookcase with No Lip	47-3/4 W x 14-1/4 D x 36 H in	3	\$927.95



QUICKSHIP Items ship within 24 hrs, 48 hrs, 1 or 2 weeks as indicated when the factory distribution center receives the order.



See Shipping & Handling terms for details.



PRODUCT CERTIFIED FOR LOW CHEMICAL EMISSIONS: UL.COM/IGG UL 2818



Podium w/Clear Trays



Podium w/Primary Trays

**Childcraft® Mobile AV Podium with Storage**

Podium features 6 cubby compartments on each side plus 30 vertical slots that can hold letter-sized folders or paper. The front of the unit features a dry-erase board. Features locking casters. Assembled.

Item #	Description	Product Dimensions	List Price
6-2003914-670	Mobile AV Podium	27-1/2 W x 29-1/8 D x 46-1/8 H	\$1,198.95
6-2005822-670	With Translucent Trays	27-1/2 W x 29-1/8 D x 46-1/8 H	\$1,389.95
6-2005823-670	With Primary Trays	27-1/2 W x 29-1/8 D x 46-1/8 H	\$1,389.95



**Childcraft® Vertical Mailbox Storage Unit**

Vertical mailbox unit features 30 slots and removable dividers for more flexible storage options. Assembled.

Item #	Description	Product Dimensions	List Price
6-1439525-670	Vertical Mailbox Storage Unit	29-1/2 W x 14-3/4 D x 35-3/4 H in	\$1,153.95



**Childcraft® 30-Cubby Horizontal Mailbox Organizer**

Removable shelves let you configure each shelf for flexible storage options and easy cleaning. Can be set on a tabletop or mounted on a wall; mounting hardware and instructions included. Assembled.

Item #	Description	Product Dimensions	List Price
6-072000-670	30-Cubby Mailbox	47-1/4 W x 11-1/2 D x 26 H in	\$843.95

**Childcraft® Vertical Storage Units**

Space-saving vertical storage unit available with two different base options provides plenty of storage to help organize your classroom. Keep items securely locked in the top cabinet that features two shelves. Not to be used as a room divider. Simple assembly required. Hardware and instructions included. Trays sold separately.

Item #	Description	Product Dimensions	List Price
6-205897-670	Storage With Locker Base	35-3/4 W x 14-3/4 D x 74-1/4 H in	\$1,371.95
6-205899-670	Storage With Shelf Base	35-3/4 W x 14-3/4 D x 74-1/4 H in	\$1,371.95

A



B







PRODUCT CERTIFIED FOR LOW CHEMICAL EMISSIONS: UL COMGG UL 2818



### Childcraft® Locking Wall-Storage Cabinet

Keep supplies safely stored with this wall-mounted, locking cabinet that has 3 storage shelves. Wall-mounting hardware and instructions included. Assembled.



Item #	Description	Product Dimensions	List Price
5-298695-670	Locking Wall Storage Cabinet	35-3/4 Wx13-3/4 Dx35-3/4 H in	\$752.95



### Childcraft® Mobile Supply Cabinet

Hidden door latches to keep important items safely tucked away. Six compartments help to organize supplies. Features heavy-duty casters.

### Childcraft® Locking Mobile Supply Cabinet

Large enough to store an entire classroom's supplies. Features an adjustable shelf, locking doors, two pullout drawers, and heavy-duty locking casters. Assembled.

Item #	Description	Product Dimensions	List Price
5-1588062-670	Mobile Supply Cabinet	30 W x 17-1/8 D x 36 H in	\$981.95

Item #	Description	Product Dimensions	List Price
6-204149-670	Mobile Supply Cabinet	36 W x 24 D x 46 H in	\$2,171.95



### Childcraft® Locking 2-Door Teacher Storage Unit

Features 4 shelves, 1 fixed and 3 adjustable for flexible storage options. Locking doors keep supplies safely stored. Assembled.

Item #	Description	Product Dimensions	List Price
6-1484118-670	Teacher Storage Cabinet	29-3/4 W x 23 D x 60 H in	\$1,294.95



### Whitney Brothers® Teacher Hideaway Station

This versatile all-in-one storage center features a locking drop-down work surface with multiple storage options. The two locking doors feature a total of eight adjustable shelves and eight fixed storage shelves. Includes clear plastic trays. Assembled.

Item #	Description	Product Dimensions	List Price
6-2096093-670	Teachers Hideaway	74 W x 29 D x 72 H in	\$2,947.95



Items ship within 24 hrs, 48 hrs, 1 or 2 weeks as indicated when the factory distribution center receives the order.



See Shipping & Handling terms for details.





PRODUCT CERTIFIED FOR LOW CHEMICAL EMISSIONS: UL.COM/GG UL 2818



**Childcraft® Double-Sided Writing Center**

Writing center with laminate desk top accommodates up to four students. Upper shelves are open on both sides and lower shelves are located on both sides of desk. Simple six-bolt assembly required. Hardware and instructions included.

Item #	Description	Product Dimensions	Top Height	List Price
6-071978-670	Double-Sided Writing Center	36-1/4 W x 40-3/4 D x 32 H in	21 in	\$1,008.95



**Childcraft® Single-Sided Writing Center**

Writing center with laminate desk top accommodates up to two students. Four upper shelves are removable and lower shelves are located on both sides of desk. Storage trays sold separately. Simple two-bolt assembly required. Hardware and instructions included.

Item #	Description	Product Dimensions	Top Height	List Price
6-1301526-670	Single-Sided Writing Center	36-1/4 Wx29-1/2 Dx32-1/4 H in	21 in	\$883.95

**Childcraft® Mobile Audio-Visual Center**

Mobile cabinet with removable dividers on middle shelf. Includes optional locking hardware kit. Heavy-duty casters. Assembled.



Item #	Description	Product Dimensions	List Price
5-071856-670	Mobile Audio-Visual Center	30 W x 17-1/8 D x 36-3/4 H in	\$852.95

**Childcraft® Mobile Audio Station with Trays**

Storage for up to eight headphones and a CD player. Three middle compartments keep CDs readily available, and one large lower compartment holds books or other supplies. Three large compartments hold deep storage trays sized 10-3/4"W x 13-3/8"D x 5-1/4"H. Heavy-duty casters. Assembled.



Item #	Description	Product Dimensions	List Price
5-205871-670	Audio Station Unit	29-3/4 W x 16-1/2 D x 29-3/4 H in	\$869.95
5-205869-670	With Primary Color Trays	29-3/4 W x 16-1/2 D x 29-3/4 H in	\$917.95
5-2027784-670	With Translucent Trays	29-3/4 W x 16-1/2 D x 29-3/4 H in	\$917.95



**Childcraft® STEM Collaboration Table**

Tabletop is 21"H to accommodate chairs or standing. Top shelves fit flat trays sized 10"W x 13"D x 5"H. Bottom shelves are open on both sides. Simple assembly required. Hardware and instructions included.

Item #	Description	Product Dimensions	Top Height	List Price
6-2041371-670	STEM Collaboration Table	30 W x 41-3/4 D x 36 H in	21 in	\$931.95
6-2048161-670	With Color Trays	30 W x 41-3/4 D x 36 H in	21 in	\$998.95
6-2048162-670	With Translucent Trays	30 W x 41-3/4 D x 36 H in	21 in	\$998.95

**Childcraft® Tabletop Writing Supplies Center**

Wooden tabletop storage unit has shelves and bins for a variety of supplies.



Item #	Description	Product Dimensions	List Price
5-1491255-670	Tabletop Center	21-1/4 W x 12 D x 12-3/8 H in	\$190.95



PRODUCT CERTIFIED FOR LOW CHEMICAL EMISSIONS: UL COM/CGG UL 2818



**CHILDCRAFT®**  
A School Specialty® Exclusive



Reading Nook w/Tan Canopy and Blue Cushions

**Childcraft® Reading Nook with Canopy**

Use this Reading Nook to create a cozy space for children to read or relax. The back panel features 2 bookshelves. Cutouts in the side panels allow the teacher to easily view their students. The unit comes with 2 sets of floor cushions and 2 canopies. Overall dimensions 49- 1/2"W x 37"D x 50"H. **Assembly required.**

Item #	Description	Product Dimensions	List Price
5-2006488-670	Green/Blue Canopy w/Blue Cush	49-1/2 W x 37 D x 50 H in	\$1,643.95
5-2006490-670	Green/Blue Canopy w/Red Cush	49-1/2 W x 37 D x 50 H in	\$1,643.95
5-2006077-670	Tan/Red Canopy w/Blue Cush	49-1/2 W x 37 D x 50 H in	\$1,643.95
5-2006075-670	Tan/Red Canopy w/Red Cush	49-1/2 W x 37 D x 50 H in	\$1,643.95
5-2005818-670	Beige/Blue Canopy w/Blue Cush	49-1/2 W x 37 D x 50 H in	\$1,643.95
5-2005820-670	Beige/Blue Canopy w/Red Cush	49-1/2 W x 37 D x 50 H in	\$1,643.95

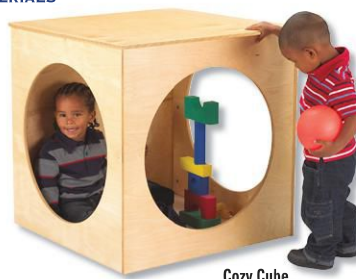

Cozy Cube



Clear Acrylic Top Cozy Cube

**Childcraft® Cozy Cube**

Cozy Cube features three open circular sides to provide visibility and one solid side to allow some privacy. The sides can be assembled in different configurations to fit your needs. Available with clear top option or Reflection Cozy Cube that includes interior shatterproof mirrors. Reversible cushion is 1" thick and wipes clean. **Some assembly required.**

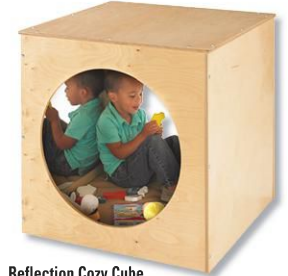

Reflection Cozy Cube

Item #	Description	Product Dimensions	List Price
<b>Wood Top</b>			
5-1335356-670	Cozy Cube	29-1/2 Wx29-1/2 Dx29-1/2 H in	\$409.95
5-2088370-670	Cozy Cube with Cushion	29-1/2 Wx29-1/2 Dx29-1/2 H in	\$490.95
5-1491056-670	Reflection Cozy Cube	29-1/2 Wx29-1/2 Dx29-1/2 H in	\$692.95
<b>Acrylic Top</b>			
5-2039674-670	Clear Acrylic Top Cozy Cube	29-1/2 Wx29-1/2 Dx29-1/2 H in	\$583.95
<b>Cushion</b>			
5-2088682-670	Cushion Only	28 L x 28 W x 1 H in	\$105.95



**Jonti-Craft® Dream Cube**

Create a retreat for students to separate themselves from the hustle and bustle of the classroom. Perfect for reading, studying, and relaxing, the Dream Cube features comfy, easy-to clean cushions and angled back rests. Double-sided Write-n-Wipe surfaces on the sides provide a space for students to jot down ideas, learning concepts, and work out problems.

Item #	Description	Product Dimensions	List Price
6-2100399-670	Dream Cube	48 W x 37-1/2 D x 46-1/2 H in	\$2,621.95



Nature Reading Haven



Nature View Play House

**Whitney Brothers® Quiet Spaces**

Create quiet spaces that children will love! These innovative retreats for children feature sturdy and safe shatterproof acrylic with imprinted realistic images that beckon children inside for a peaceful break yet provide easy visibility for adult supervision. The cozy interiors include durable, comfy floor pads.

Item #	Description	Product Dimensions	List Price
5-2051408-670	Nature Reading Haven	39-1/2 W x 39 D x 38 H in	\$1,987.95
5-2051409-670	Nature View Play House	30-1/4 W x 30 D x 30 H in	\$917.95



QUICKSHIP  
Items ship within 24 hrs, 48 hrs, 1 or 2 weeks as indicated when the factory distribution center receives the order.



See Shipping & Handling terms for details.





PRODUCT CERTIFIED FOR LOW CHEMICAL EMISSIONS: UL.COM/SG UL 2818



Back

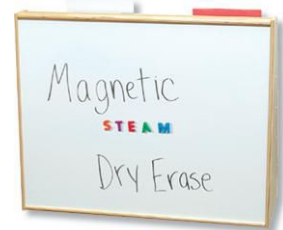

Back

**Childcraft® 5-Shelf Book Display with Shelves**

Unit has five shelves on one side to display books and three long open shelves on the back. Assembled.

Item #	Description	Product Dimensions	List Price
5-068675-670	5-Shelf w/ Shelves	36 W x 12 D x 29 H in	\$371.95

**Childcraft® 5-Shelf Book Display with Magnetic Dry-Erase Back Panel**

Unit has five front shelves to display books and a magnetic dry-erase board on back panel. Assembled.

Item #	Description	Product Dimensions	List Price
5-204148-670	5-Shelf w/ Magnetic Dry-Erase	36 W x 12 D x 29 H in	\$558.95



Sized for Toddlers



Back

**Childcraft® Toddler 3-Shelf Book Display with Dry-Erase Back Panel**

Unit has three front shelves with high strips on each to display books and keep them in place. Each shelf is 22-3/4"W x 1-1/2"D. Large bottom shelf is 8-1/2"D. Dry-erase board on back panel. Assembled.

Item #	Description	Product Dimensions	List Price
5-1291233-670	3-Shelf w/ Dry-Erase	24 W x 9 D x 24 H in	\$297.95

**Childcraft® 4-Shelf Book Display with Dry-Erase Back Panel**

Unit has four front shelves with deep strips on each to display books and keep them in place. Dry-erase board on back panel. Assembled.

Item #	Description	Product Dimensions	List Price
5-272071-670	4-Shelf w/ Dry-Erase	36 W x 11-3/4 D x 29 H in	\$327.95



**Childcraft® Toddler Low Library**

Low, four-shelf book display is perfect for toddlers. Assembled.

Item #	Description	Product Dimensions	List Price
5-1464144-670	Toddler Low Library	30 W x 15-1/2 D x 14 H in	\$232.95



Reverse Side



**Childcraft® ABC® Furnishings Library Book Display**

Unit has three front book shelves and three rear open shelves of varying depths. Assembly required.

Item #	Description	Product Dimensions	List Price
9-1526415-670	Book Display	35-3/4 W x 14-1/2 D x 30 H in	\$312.95





PRODUCT CERTIFIED FOR LOW CHEMICAL EMISSIONS: UL.COM/GG UL 2818

ASSEMBLED IN U.S.A. WITH GLOBAL MATERIALS

**CHILDCRAFT®**  
A School Specialty® Exclusive



**Childcraft® Mobile Double-Sided Book Display**

Mobile unit has four book display shelves on each side. Heavy-duty locking casters. Assembled.

Item #	Description	Product Dimensions	List Price
6-1528659-670	Double-Sided Book Display	36 W x 23-3/4 D x 30-1/4 H in	\$996.95



Book Display

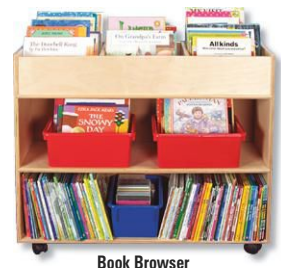

Book Browser

**Childcraft® Mobile Double-Sided Unit**

Double-sided, mobile unit features book display with four shelves on one side and book browser with three book bins and two shelves on the other side.

Item #	Description	Product Dimensions	List Price
6-1318389-670	Book Display / Book Browser	36 W x 20 D x 30 H in	\$996.95



**Childcraft® Single-Sided Mobile Book Center**

Mobile book storage with four upper and four lower compartments, each measuring 11-1/8"W x 13-1/8"D. Heavy-duty casters. Assembled.

Item #	Description	Product Dimensions	List Price
6-272110-670	Single-Sided Mobile Center	47-3/4 Wx14-1/2 Dx25-3/4 H in	\$884.95



Unit Secured on Top of a 14-1/4" D Storage Unit (Sold Separately)

**Childcraft® Library Topper**

Unit features three upper shelves and four bottom storage cubbies. Cubbies can hold four - 10-3/4"W x 13-1/4"D x 3"H storage trays. Topper includes hook and loop strips for securing to other 14-1/4"D storage units, a table top, or other surface. Assembled.

Item #	Description	Product Dimensions	List Price
5-1560517-670	Library Stacker	46-1/4 Wx14-1/4 Dx13-3/4 H in	\$619.95
5-1568765-670	w/4 Primary Color Flat Trays	46-1/4 Wx14-1/4 Dx13-3/4 H in	\$688.95
5-1568766-670	w/4 Translucent Flat Trays	46-1/4 Wx14-1/4 Dx13-3/4 H in	\$688.95

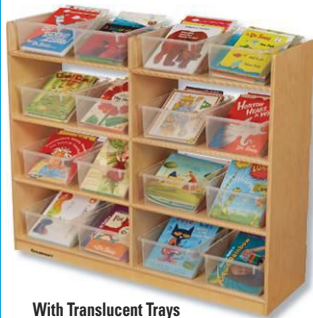

With Translucent Trays

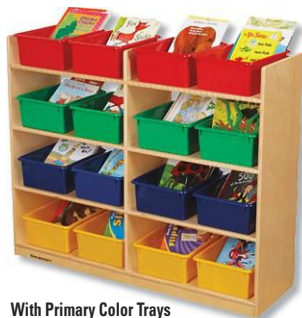

With Primary Color Trays

**Childcraft® Mobile Leveled Library**

Mobile book storage holds sixteen 10-3/4"W x 13-3/8"D x 5-1/4"H storage trays. Heavy-duty casters. Assembled.

Item #	Description	Product Dimensions	List Price
6-1590934-670	Mobile Leveled Library	47-3/4 Wx14-1/4 Dx39-13/16 H in	\$1,129.95
6-1592484-670	With Primary Color Trays	47-3/4 Wx14-1/4 Dx39-13/16 H in	\$1,384.95
6-1592398-670	With Translucent Trays	47-3/4 Wx14-1/4 Dx39-13/16 H in	\$1,384.95

**Childcraft® Mobile 4-Sided Library**

Mobile unit stores and displays books on three big shelves on all four sides. Heavy-duty casters. Assembled.



Item #	Description	Product Dimensions	List Price
6-071870-670	Mobile 4-Sided Library	23-1/2 Wx23-1/2 Dx43-1/4 H in	\$677.95



60"H with 3 Adjustable Shelves

48"H with 3 Adjustable Shelves

36"H with 2 Adjustable Shelves

**Childcraft® Adjustable Shelf Bookcases**

Three bookcase options in various heights. Choice of units with two or three adjustable shelves. Not recommended as a room divider. Assembled.

Item #	Description	Product Dimensions	Number of Shelves	List Price
6-1291235-670	2 Adjustable Shelves	35-3/4 W x 11-5/8 D x 36 H in	3	\$631.95
6-1291237-670	3 Adjustable Shelves	35-3/4 W x 11-5/8 D x 48 H in	4	\$760.95
6-1457590-670	3 Adjustable Shelves	35-3/4 W x 11-5/8 D x 60 H in	5	\$935.95



30"H Mobile Bookcase with Lip

**Childcraft® Adjustable Mobile Bookcases**

Mobile bookcase with adjustable shelves. Units with lip allow for display room on top. Heavy-duty casters. Assembled.

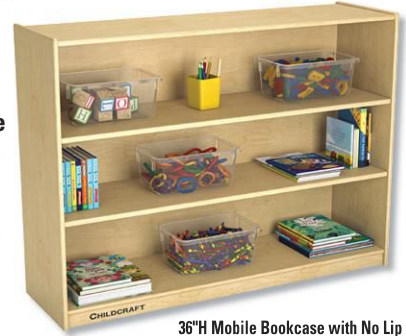

36"H Mobile Bookcase with No Lip

Item #	Description	Product Dimensions	Number of Shelves	List Price
6-1464171-670	Mobile Bookcase with Lip	47-3/4 W x 14-1/4 D x 30 H in	2	\$713.95
6-1464172-670	Mobile Bookcase with Lip	47-3/4 W x 14-1/4 D x 36 H in	3	\$927.95
6-1464415-670	Mobile Bookcase with No Lip	47-3/4 W x 14-1/4 D x 36 H in	3	\$927.95



2-Shelf

**Childcraft® Mobile Open Adjustable Shelving Units with Locking Casters**

Mobile shelving unit with adjustable shelves. Dual-wheel locking casters. Assembled.



3-Shelf

Item #	Description	Product Dimensions	Number of Shelves	List Price
5-1558444-670	Adjustable Shelf Unit	35-3/4 W x 14-1/4 D x 24 H in	2	\$459.95
6-1558449-670	Adjustable Shelf Unit	35-3/4 W x 14-1/4 D x 36 H in	3	\$596.95



2-Shelf

**Childcraft® Mobile Open Shelving Units with Adjustable Dividers and Locking Casters**

Mobile shelving unit with adjustable shelves and sliding dividers. Dual-wheel locking casters. Assembled.



3-Shelf

Item #	Description	Product Dimensions	Number of Shelves	List Price
6-1558438-670	Adjustable Divider Unit	47-3/4 W x 14-1/4 D x 30 H in	2	\$734.95
6-1558450-670	Adjustable Divider Unit	35-3/4 W x 14-1/4 D x 42 H in	3	\$734.95
9-1564567-670	Extra Dividers - Set of 4	12-1/2 W x 7 H in	-	\$92.95





PRODUCT CERTIFIED FOR LOW CHEMICAL EMISSIONS: UL.COM/GG UL 2818



**CHILDCRAFT®**  
A School Specialty® Exclusive



**Childcraft® Mobile Magnetic Dry-Erase Double-Sided Easels**

Mobile, double-sided easel with magnetic dry-erase boards on both sides. Top dowel includes three binder rings to hang pocket charts or large chart pads. Bottom compartments hold 11"W x 16"D x 6"H storage trays with lids. Heavy-duty locking casters. Assembled.

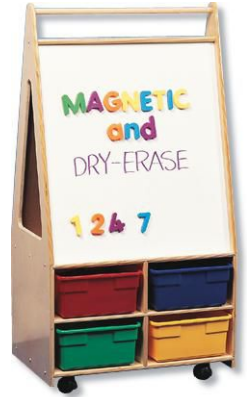

**Childcraft® Magnetic Dry-Erase Mobile Language Center**

Mobile unit features a top that lifts and locks into place to display big books with additional storage underneath. The lower section has a magnetic dry-erase panel in the front and big book storage slots in the back. Heavy-duty casters. Assembled.

Item #	Description	Product Dimensions	List Price
5-204150-670	Magnetic Dry-Erase Center	24-1/2W x 14-5/8D x 32-3/4H in	\$507.95



Item #	Description	Product Dimensions	List Price
5-298694-670	Double-Sided Easel	24-3/4 W x 16 D x 46 H in	\$1,325.95
5-299384-670	w/4 Primary Color Trays w/Lids	24-3/4 W x 16 D x 46 H in	\$1,397.95

**Childcraft® Mobile Big Book Storage Unit**

Mobile storage unit has four large compartments that can hold approximately 80 big books. Also works for storing posters and other large items. Heavy-duty casters. Assembled.

Item #	Description	Product Dimensions	List Price
5-249519-670	Big Book Storage	29-3/4 Wx12-1/2 Dx22-1/4 H in	\$413.95



**Childcraft® ABC® Furnishings Tabletop Book Display**

Book display holds approximately 40 books. Hardware and instructions included. Assembly required.

Item #	Description	Product Dimensions	List Price
9-072011-670	Tabletop Book Display	24 W x 11-1/2 D x 11-1/2 H in	\$157.95



**Childcraft® Floor Teaching Easel**

Easel sits on the floor and features a dry-erase panel on each side, a ledge on the front to support books or small items such as markers, and a small storage shelf inside. Folds easily for storage. Assembled.

Item #	Description	Product Dimensions	List Price
5-2039671-670	Floor Easel	29-3/4 W x 14 D x 35 H in	\$319.95



Front



**Childcraft® Mobile Learn and Store Activity Station**

This multi-purpose station features two magnetic dry-erase panels, one dry-erase panel on the door, and one pegboard panel. Easel trays attach under each dry-erase panel. Extra storage is provided with one bottom shelf and three deep upper shelves behind the door. Heavy-duty locking casters. Assembled.

Item #	Description	Product Dimensions	List Price
6-2041370-670	Mobile Activity Station	25-1/2 W x 25-1/2 D x 42 H in	\$1,117.95





A



B



C



**Copernicus Leveled-Reading Book Browser Carts**

Organize leveled-reading books in the classroom or library with three rows of easily accessible portable storage. All carts feature 2" locking casters. Racks include 2 small and 1 large book display rack. Lifetime frame and tub warranty.

Item #	Description	Product Dimensions	List Price
5-2028161-670	Clear Tubs	40-1/2 Wx15-3/4 Dx36-1/2 H in	\$401.95
A 5-2096434-670	100% Recycled Tubs <b>NEW</b>	40-1/2 Wx15-3/4 Dx36-1/2 H in	\$377.95
B 5-2096436-670	Vibrant Tubs <b>NEW</b>	40-1/2 Wx15-3/4 Dx36-1/2 H in	\$377.95
5-2096438-670	Vibrant Cool Tubs <b>NEW</b>	40-1/2 Wx15-3/4 Dx36-1/2 H in	\$377.95
5-2096435-670	Vibrant Warm Tubs <b>NEW</b>	40-1/2 Wx15-3/4 Dx36-1/2 H in	\$377.95
5-2096433-670	Deluxe Tub Pack	40-1/2 Wx15-3/4 Dx36-1/2 H in	\$395.95
C 5-082604-670	Small Primary Tubs	40-1/2 Wx15-3/4 Dx36-1/2 H in	\$377.95
5-082602-670	Blue/Green/Yellow Tubs	40-1/2 Wx15-3/4 Dx36-1/2 H in	\$377.95
5-082603-670	Small Primary Tubs w/Racks	49 W x 21 D x 36-1/2 H in	\$760.95
D 5-080120-670	Blue/Green/Yellow Tubs & Racks	49 W x 21 D x 36-1/2 H in	\$713.95



D

**Metal Folding Library Book Stand**

Four-tiered shelves display dozens of books in one compact space. Great for tabletop displays, libraries, reading corners, book fairs, and more. Economical and lightweight. Folds flat for convenient storage. 4.6 lbs.



**Metal Book Storage Rack**

Sturdy metal rack designed to hold up to 30 read-along book-and-tape or CD set bags. Non-slip rubber-tipped feet protect tabletops. Easy assembly; hardware and instructions included. 6 lbs. Bags sold separately.



Item #	Description	Product Dimensions	List Price
9-1605024-670	Metal Book Stand	23-3/4W x 10-3/4D x 17-3/4H in	\$90.95

Item #	Description	Product Dimensions	List Price
9-1601439-670	Read-Along Rack - Blue	18 W x 12 D x 18 H in	\$52.95

**Monaco Deluxe HangUp® Bags**

These portable storage bags are great for use at home, the office and classrooms. Deluxe bags feature a sturdy handle with easy to open-and-close thumb grips. Made from robust 4-mil clear polyethylene plastic that will stand up to the rigors of classroom use. Bags are reusable and can be sanitized. **Set of 5.**



Item #	Product Dimensions	List Price
9-1540076-670	10 W x 7-1/2 H in	\$9.35
9-1540077-670	12 W x 9 H in	\$10.05
9-1540078-670	10 W x 12-1/2 H in	\$10.55
9-1540079-670	14 W x 12-1/2 H in	\$10.95
9-1540081-670	14 W x 21 H in	\$14.95
9-1540082-670	16 W x 25 H in	\$19.95

**Monaco Original HangUp® Bags**

Sturdy, portable storage bags for media materials, crafts, sewing & knitting accessories, books, charts and so much more. Robust 4-mil clear polyethylene plastic stands up to the rigors of classroom use. White plastic handle hook with snap-shut closure. Bags are reusable and can be sanitized. **Set of 10.**



Item #	Product Dimensions	List Price
9-658929-670	9 W x 8 H in	\$15.95
9-658930-670	8-1/2 W x 10 H in	\$16.95
9-650362-670	10 W x 13-1/2 H in	\$17.95
9-658931-670	13-1/2 W x 13-1/2 H in	\$18.95
9-200356-670	12-1/2 W x 14-1/2 H in	\$18.95
9-658932-670	14 W x 21 H in	\$23.95
9-658933-670	16 W x 25 H in	\$27.95
9-650365-670	20 W x 25 H in	\$27.95
9-256905-670	22 W x 28 H in	\$30.95



A



B



C



D

### Copernicus® Bamboo Book Browser Cart

This bamboo cart can be used as a mobile in-class library or for maker space materials. Sturdy frame with 3" locking casters can hold up to 90 pounds. Includes 9 tubs. Lifetime warranty.

Item #	Description	Product Dimensions	List Price
5-2091726-670	Sage Tubs	40-1/2 W x 22 D x 36-1/2 H in	\$415.95
A 5-2091720-670	Vibrant Cool Tub Combo	40-1/2 W x 22 D x 36-1/2 H in	\$415.95
B 5-2091729-670	Vibrant Tub Combo	40-1/2 W x 22 D x 36-1/2 H in	\$415.95
C 5-2091724-670	Vibrant Warm Tub Combo	40-1/2 W x 22 D x 36-1/2 H in	\$415.95
D 5-2091725-670	100% Recycled Tubs	40-1/2 W x 22 D x 36-1/2 H in	\$415.95



Single-Sided



Double-Sided

### Copernicus Bamboo Teaching Easel

Eco-friendly design brings natural elements into the classroom.

- Magnetic dry-erase whiteboard and adjustable book ledge
- Four sliding open tubs, bamboo middle shelf with big book racks, and four locking casters
- Lifetime warranty on easel and tub components/5-year warranty on whiteboards

Item #	Description	Product Dimensions	List Price
5-2028158-670	Single Sided Easel	30-1/2 W x 27 D x 57 H in	\$747.95
5-2092379-670	Easel w/ Recycled Tubs <b>NEW</b>	30-1/2 W x 27 D x 57 H in	\$913.95
5-1402809-670	Double-Sided Easel	30-1/2 W x 27 D x 57 H in	\$913.95
5-2092377-670	Easel w/ Lids <b>NEW</b>	30-1/2 W x 27 D x 57 H in	\$959.95

### Copernicus® Small Bamboo Book Browser Cart

Small bamboo cart can be used as a mobile in-class library or for maker space materials. Sturdy frame with 3" locking casters can hold up to 60 pounds. Includes 6 tubs. Lifetime warranty.



Item #	Description	Product Dimensions	List Price
5-2091723-670	Sage Tubs	28 W x 18-3/4 D x 36-1/2 H in	\$351.95
5-2091733-670	Vibrant Cool Tub Combo	28 W x 18-3/4 D x 36-1/2 H in	\$351.95
5-2091721-670	Vibrant Tub Combo	28 W x 18-3/4 D x 36-1/2 H in	\$351.95
5-2091719-670	Vibrant Warm Tub Combo	28 W x 18-3/4 D x 36-1/2 H in	\$351.95

### Copernicus® Bamboo Early Learning Station

This easel's natural aesthetic is perfect in a neutral early childhood environment.

- Folding design allows for easy set-up and storage
- Two magnetic dry-erase whiteboards, one side with solid/dotted/solid line sequence
- Roll-up felt with corner ties and magnets
- Premium adjustable book ledge, two open tubs, and snap-on chart paper hooks
- Lifetime warranty on easel and tub components/5-year warranty on whiteboards



Item #	Description	Product Dimensions	List Price
5-2091743-670	Sage Tubs	40-1/2 W x 26 D x 47-3/4 H in	\$569.95
5-2091744-670	Vibrant Tub Combo	40-1/2 W x 26 D x 47-3/4 H in	\$569.95



### Copernicus Bamboo Deluxe Chart Stand

Eco-friendly bamboo chart stands provide a sustainable option for classrooms.

- Double-sided magnetic dry-erase whiteboard
- Adjustable book ledge, 2 open tubs, snap-on chart paper hooks
- Height-adjustable
- Lifetime warranty on easel and tub components/5-year warranty on whiteboards

Item #	Description	Product Dimensions	List Price
5-2091737-670	Sage Tubs	28-1/2 W x 28 D x 70 H in	\$446.95
5-2091739-670	Vibrant Tub Combo	28-1/2 W x 28 D x 70 H in	\$446.95





Single classroom use - PreK - 2

**Copernicus Early Learning Station**

The Early Learning Station is perfect for early childhood and primary classrooms.

- Folding design allows for easy set-up and storage
- Two magnetic dry-erase whiteboards, one side with solid/dotted/solid line sequence
- Roll-up felt with corner ties and magnets
- Premium adjustable book ledge, two open tubs, and snap-on chart paper hooks
- Lifetime warranty on easel and tub components/5-year warranty on whiteboards



Item #	Description	Product Dimensions	List Price
5-087367-670	Early Learning Station	26 W x 29-1/2 D x 47-3/4 H in	\$476.95



**Copernicus Double-Sided Art Easel**

Create the perfect arts & crafts station! New Base Model includes five drying racks vs. ten.

- Two height-adjustable dry-erase painting surfaces
- Built-in drying racks
- Two removable paint trays with paint pots and caps
- Four locking casters
- Lifetime warranty on easel and tub components/5-year warranty on whiteboards

Item #	Description	Product Dimensions	List Price
5-2106493-670	Base Model	<b>NEW</b> 27-1/2 W x 29-1/2 D x 51 H in	\$541.95
5-411288-670	Double-Sided Art Easel	27-1/2 W x 29-1/2 D x 51 H in	\$647.95



**Copernicus Tabletop Easel**

This compact, double-sided Tabletop Easel is ideal for guided reading programs and small group instruction. Whiteboard is magnetic. Folds easily for storage. For use at desk or floor. Lifetime warranty.

Item #	Description	Product Dimensions	List Price
5-679458-670	Tabletop Easel - Blue	19 W x 17 D x 19 H in	\$126.95



**Copernicus Primary Teaching Easel**

Designed for early childhood and primary environments.

- Front magnetic dry-erase board
- Rear removable/adjustable felt board
- Adjustable book ledge locks into multiple positions
- Big book rack, four small open tubs, four 2" casters
- Lifetime warranty on easel and tub components/5-year warranty on whiteboards

Item #	Description	Product Dimensions	List Price
5-085987-670	Primary Teaching Easel	30 W x 31-1/2 D x 58 H in	\$489.95



**NEW**



**Copernicus® 2-in-1 Royal Teaching Easel with Portable Whiteboard**

This new take on a classroom favorite has all the useful features that educators need in a teaching easel, plus a removable whiteboard. The whiteboard may be used as a portable easel for field trips, in an outdoor classroom, or online.

Item #	Description	Product Dimensions	List Price
5-2096423-670	Portable Whiteboard	33 W x 29 D x 58 H in	\$784.95



**NEW**

**Copernicus® Pack and Go Whiteboard Easel**

This whiteboard works well as a key component in setting up an outdoor classroom. The easel is lightweight, has a comfortable shoulder strap for hands-free carrying or suspending from hooks, a marker pocket, and a kickstand to set it up at an angle.

Item #	Description	Product Dimensions	List Price
9-2096428-670	Pack and Go Easel	36 W x 3 D x 25 H in	\$228.95





Single classroom use - PreK - 5



### Copernicus Basic Royal® Reading Writing Center

This easel features the quality build of all our teaching centers, as well as an attractive price point for tight budgets.

- Large magnetic dry erase surface with adjustable book ledge
- 3 Open Tubs, 2 Small Open Tubs and Tiny Tub
- Chart paper hooks to store extra paper
- Lifetime warranty on easel and tub components/5-year warranty on whiteboards

Item #	Description	Product Dimensions	List Price
5-1574881-670	Basic Royal	33 W x 27 D x 59 H in	\$581.95
5-2096427-670	Vibrant Tub Combo <b>NEW</b>	33 W x 27 D x 59 H in	\$581.95
5-2096422-670	Basic Royal w/ Lids <b>NEW</b>	33 W x 27 D x 59 H in	\$611.95
5-2096414-670	Vibrant Tub Combo with Lids <b>NEW</b>	33 W x 27 D x 59 H in	\$611.95

### Copernicus Regal™ Reading/Writing Center

The Regal™ Reading Writing Center is a valuable teaching tool for primary and junior classes.

- Front magnetic dry-erase surface
- Rear removable dry-erase board
- Adjustable book ledge, four sliding tubs, and snap-on chart paper hooks
- Lifetime warranty on easel and tub components/5-year warranty on whiteboards



Item #	Description	Product Dimensions	List Price
5-1300060-670	Regal	32 W x 31 D x 56 H in	\$680.95
5-2096418-670	Vibrant Tub Combo <b>NEW</b>	32 W x 31 D x 56 H in	\$680.95
5-2096419-670	Regal w/Lids <b>NEW</b>	32 W x 31 D x 56 H in	\$714.95
5-2096426-670	Vibrant Tub Combo w/ Lids <b>NEW</b>	32 W x 31 D x 56 H in	\$714.95



### Copernicus Classic Royal® Reading/Writing Center

Loaded with useful features, this easel has been one of our most popular products for over 25 years!

- Front magnetic dry-erase surface
- Rear removable double-sided dry-erase board (lined on one side)
- Adjustable book ledge, large middle shelf, Big Book racks, four sliding tubs, and snap-on chart paper hooks
- Lifetime warranty on easel and tub components/5-year warranty on whiteboards



Item #	Description	Product Dimensions	List Price
5-202691-670	Classic Royal	33 W x 27 D x 56-1/2 H in	\$674.95
5-2096412-670	Vibrant Tub Combo <b>NEW</b>	33 W x 27 D x 56-1/2 H in	\$674.95
5-2096417-670	Classic Royal w/Lids <b>NEW</b>	33 W x 27 D x 56-1/2 H in	\$707.95
5-2096416-670	Vibrant Tub Combo w/ Lids <b>NEW</b>	33 W x 27 D x 56-1/2 H in	\$707.95

### Copernicus Royal® Reading/Writing Centers

This Reading/Writing Center is an essential tool for all primary classrooms.

- Front magnetic dry-erase surface
- Rear removable double-sided dry-erase board (lined on one side)
- Adjustable book ledge, large middle shelf, Big Book racks, 2 tiny tubs, 4 sliding open tubs with safety stops, and snap-on chart paper hooks, and four casters (two locking)
- Lifetime warranty on easel and tub components/5-year warranty on whiteboards



Item #	Description	Product Dimensions	List Price
5-1300056-670	Standard Royal	31-1/2 W x 32 D x 56-1/2 H in	\$685.95
5-2096415-670	Vibrant Tub Combo <b>NEW</b>	31-1/2 W x 32 D x 56-1/2 H in	\$685.95
5-2096420-670	Standard Royal w/ Lids <b>NEW</b>	31-1/2 W x 32 D x 56-1/2 H in	\$719.95
5-2096413-670	Vibrant Tub Combo w/ Lids <b>NEW</b>	31-1/2 W x 32 D x 56-1/2 H in	\$719.95

### Copernicus Premium Royal® Reading Writing Center

This versatile teaching easel provides an organized lesson center in one compact footprint along with mobility throughout the classroom.

- Large magnetic dry-erase surface, premium book ledge, chart paper hooks
- 6 Open Tubs, 4 Small Open Tubs, 8 Tiny Tubs
- 3 Book Folders
- Lifetime warranty on easel and tub components/5-year warranty on whiteboards

Item #	Description	Product Dimensions	List Price
5-1574882-670	Premium Royal	33 W x 27 D x 59 H in	\$907.95
5-2096425-670	Vibrant Tub Combo <b>NEW</b>	33 W x 27 D x 59 H in	\$907.95
5-2096421-670	Premium Royal w/Lids <b>NEW</b>	33 W x 27 D x 59 H in	\$970.95
5-2096424-670	Vibrant Tub Combo w/ Lids <b>NEW</b>	33 W x 27 D x 59 H in	\$970.95



Magnetic Dry-Erase

**Copernicus Deluxe Chart Stand**

This Deluxe Chart Stand is a valuable tool for group and independent activities.

- Double-sided magnetic dry-erase whiteboard
- Adjustable book ledge, 2 open tubs, and snap-on chart paper hooks
- Board height adjustable upon assembly
- Lifetime warranty on easel and tub components/5-year warranty on whiteboards

Item #	Description	Product Dimensions	List Price
5-076779-670	Magnetic Dry Erase	28 W x 27 D x 50-69-1/2 H in	\$381.95

**Copernicus Basic Chart Stand**

Built for flexibility and value, the Basic Chart Stand is an economical easel choice for budget-conscious classrooms.

- Dry-erase whiteboard
- Snap-on chart paper hooks
- Adjustable bottom bar for various tub sizes - tubs not included
- 2" casters (two locking)
- Lifetime frame warranty/5-year warranty on whiteboards



Item #	Description	Product Dimensions	List Price
5-1411147-670	Basic Chart Stand	25-1/2 W x 24 D x 60-1/4 H in	\$211.95

**Copernicus Teacher Trolley**

Resource and travelling teachers will love this trolley; with storage, a book ledge, and even a place for file folders, everything is ready to move!

- Removable magnetic dry-erase whiteboard
- Chart hooks for chart paper and hanging pockets for additional storage
- 3 small open tubs, 1 large open tub, and 3 tiny tubs
- Built-in book and marker ledge and 3" casters
- Lifetime warranty on easel and tub components/5-year warranty on whiteboards



Item #	Description	Product Dimensions	List Price
5-1407120-670	Teacher Trolley	20 W x 16 D x 46 H in	\$483.95

**Copernicus Outdoor/Indoor Learning Center**

The Outdoor/Indoor Learning Center is rugged and flexible to support a variety of outdoor or indoor activities.

- Adjustable magnetic dry erase board
- Lower storage compartment
- Two large tubs with lids and repositionable tiny tub
- Large pneumatic wheels
- Lifetime warranty on cart and tub components/5-year warranty on whiteboards



Item #	Description	Product Dimensions	List Price
5-2028159-670	Outdoor/Indoor Learning Center	42-1/4 Wx23-1/2 Dx57-1/2 H in	\$759.95

**Copernicus Royal® Inspiration Stations**

The Inspiration Station was designed in collaboration with educators, incorporating many innovative features to make teaching easier.

**Standard Royal**

- Front magnetic dry-erase surface with slide-out board
- Includes 4 open tubs, 1 big tub, 2 tiny tubs, big book rack, and adjustable book ledge
- Top shelf for teacher storage, chart paper hooks and telescoping hooks to accommodate wide pocket charts, and four casters (two locking)
- Lifetime warranty on easel and tub components/5-year warranty on whiteboards

**Premium Royal**

Includes all Standard features plus:

- 10 open tubs, 8 tiny tubs that fit into open tubs and 1 big tub
- Rear removable double-sided dry-erase board (lined on one side)

Item #	Description	Product Dimensions	List Price
5-679452-670	Standard Inspiration Station	30 W x 30 D x 64-1/2 H in	\$996.95
5-679453-670	Premium Inspiration Station	30 W x 30 D x 64-1/2 H in	\$1,398.95



Open Tub



Removable lined magnetic dry erase board







PRODUCT CERTIFIED FOR LOW CHEMICAL EMISSIONS: UL.COM/IGG UL 2818



**CHILDCRAFT**  
A School Specialty Exclusive



Double Adjustable Easel with Drying Rack



Easel w/ Drying Rack

### Childcraft® Double Adjustable Easel with Dry-Erase Panels

Easel features solid-maple frame with two adjustable dry-erase panels. Includes cross rails for extra stability, locking metal stay arms to hold the easel open, non-skid rubber feet, four large clips, and two removable paint trays that hold up to ten paint cups. Easel stands 44-1/2" when open. Assembly required. Hardware and instructions included.

Item #	Description	List Price
5-074493-670	Double Adjustable Easel	\$365.95
5-296213-670	Easel W/ Paper Roll and Holder	\$395.95
5-296312-670	Easel W/ Drying Rack	\$533.95



Two Easel Center



Mobile Four Easel Center

### Childcraft® Two- and Four-Easel Centers

Easel includes bottom shelves for storage and adjustable dry-erase panels on each side for tray heights between 18-1/8" and 29-1/2" from the floor. Paint trays are removable for easy cleaning. Four-Easel Center features heavy-duty casters for mobility. Assembly required. Hardware and instructions included.

Item #	Description	Product Dimensions	List Price
5-271567-670	Two Easel Center	26-1/8 W x 13 D x 49-3/8 H in	\$632.95
6-271543-670	Mobile Four Easel Center	47-3/4 W x 13 D x 50-1/8 H in	\$1,154.95

### Metal Art Easel

Lightweight easel is double-sided with easy-to-clean, tough, coated boards on each side. Folds for storage.



Item #	Description	Product Dimensions	List Price
5-1298769-670	Art Easel	25 W x 24 D x 46 H in	\$155.95
5-1299463-670	Art Easel With Trays	25 W x 24 D x 46 H in	\$297.95



Reverse



Front

### Childcraft® Mobile Art Cart

This easy-to-clean mobile cart features a top with sides for storage, one side bin to store tall rolls of paper or fabric, and additional storage on two sides that include adjustable lower shelves and removable dividers. Dual-wheel locking casters. Assembled.

Item #	Description	Product Dimensions	List Price
6-1457568-670	Mobile Art Cart	30 W x 24 D x 33 H in	\$523.95



### Copernicus® Double-Sided Art Easel

Create the perfect arts & crafts station! New Base Model includes five drying racks vs. ten.

- Two height-adjustable dry-erase painting surfaces
- Built-in drying racks
- Two removable paint trays with paint pots and caps
- Four locking casters
- Lifetime warranty on easel and tub components/5-year warranty on whiteboards



Item #	Description	Product Dimensions	List Price
5-2106493-670	Base Model <b>NEW</b>	27-1/2 W x 29-1/2 D x 51 H in	\$541.95
5-411288-670	Double-Sided Art Easel	27-1/2 W x 29-1/2 D x 51 H in	\$647.95



### Copernicus® Bamboo Art Carts

This bamboo cart can be used as a mobile art cart or for maker space materials. Sturdy frame with 3" locking casters can hold up to 90 pounds. Includes 9 tubs. Lifetime warranty.



Vibrant Cool Tub Combo

Item #	Description	Product Dimensions	List Price
5-2091726-670	Sage Tubs	40-1/2 W x 22 D x 36-1/2 H in	\$415.95
5-2091720-670	Vibrant Cool Tub Combo	40-1/2 W x 22 D x 36-1/2 H in	\$415.95
5-2091729-670	Vibrant Tub Combo	40-1/2 W x 22 D x 36-1/2 H in	\$415.95
5-2091724-670	Vibrant Warm Tub Combo	40-1/2 W x 22 D x 36-1/2 H in	\$415.95
5-2091725-670	100% Recycled Tubs	40-1/2 W x 22 D x 36-1/2 H in	\$415.95



Items ship within 24 hrs, 48 hrs, 1 or 2 weeks as indicated when the factory distribution center receives the order.



See Shipping & Handling terms for details.





**CHILDCRAFT**  
A School Specialty Exclusive

ASSEMBLED  
IN U.S.A.  
  
WITH GLOBAL  
MATERIALS



PRODUCT CERTIFIED  
FOR LOW CHEMICAL  
EMISSIONS:  
UL COM/CGG  
UL 2818



**Childcraft® Portable Handwashing Sink**

Portable sink is equipped with two, 5-gallon vented water tanks for clean and waste water. No plumbing necessary, just plug it in. Features 5" deep stainless steel sink with metered faucet and laminate countertop. Soap dispenser holds up to 16 oz. of liquid soap. Heavy-duty locking casters. Assembled.

Item #	Description	Product Dimensions	List Price
6-2039501-670	Portable Sink	30 W x 24 D x 26 H in	\$3,391.95



**Abilitations® SecureSTEP™**

The SecureSTEP™ was designed to assist all children in reaching heights, countertops, desktops, etc with security. SecureSTEP™ features three 18-3/4"W x 5"H wooden stairs with no-slip treading, a solid handrail, and a rear safety stop. Stairs are appealing to kids and secure enough for parents' and therapists' comfort. Ideal for kitchens, homes, clinics, or schools. Institutional quality materials and craftsmanship.



Item #	Description	Product Dimensions	Quantity	List Price
5-1387311-670	SecureSTEP	20 W x 26 D x 35-3/4 H in	Each	\$475.99

**CHILDCRAFT**  
A School Specialty Exclusive

ASSEMBLED  
IN U.S.A.  
  
WITH GLOBAL  
MATERIALS



PRODUCT CERTIFIED  
FOR LOW CHEMICAL  
EMISSIONS:  
UL COM/CGG  
UL 2818



**Childcraft® Toddler SecureSTEP™**

This two-step unit includes handles with easy-to-grasp cutouts on each side. The wide and deep steps include non-skid strips for safety. Assembled.



Item #	Description	Product Dimensions	Number of Steps	List Price
5-1387318-670	SecureSTEP™ Toddler	19-1/2 W x 19-1/2 D x 32 H in	2	\$395.95



PRODUCT CERTIFIED  
FOR LOW CHEMICAL  
EMISSIONS:  
UL COM/CGG  
UL 2818

Touch-Free  
Faucet Adapter



**Jonti-Craft® Clean Hands Helper Portable Sinks**

Set up a portable hand washing station without plumbing! Encourage hand washing habits and help keep everyone healthy while meeting licensing requirements. Water is heated by the tankless, on-demand water heater. The water pump has a flow rate of up to half a gallon per minute. The tank for the non-potable clean water holds five gallons while the waste water tank holds six gallons. There is a catch tray under the tanks. Mistake-proof connectors means the clean and waste water tanks cannot be inadvertently switched. Plastic and stainless steel sinks are available, and are approximately 5" deep. Power switch inside the cabinet and openings for cord management.

Item #	Description	Product Dimensions	List Price
6-1580547-670	26" Counter, Plastic Sink	28-1/2 W x 23-1/2 D x 38 H in	\$4,124.95
6-1580548-670	26" Counter, S. Steel Sink	28-1/2 W x 23-1/2 D x 38 H in	\$4,425.95
6-1580549-670	38" Counter, Plastic Sink	28-1/2 W x 23-1/2 D x 49-1/2 H in	\$4,217.95
6-1580550-670	38" Counter, S. Steel Sink	28-1/2 W x 23-1/2 D x 49-1/2 H in	\$4,508.95
5-2010681-670	Accessories Kit	15-1/2 W x 13 D x 3-1/2 H in	\$200.95
9-2048103-670	Touch-Free Faucet Adapter	2 W x 2 D x 3 H in	\$307.95



PRODUCT CERTIFIED  
FOR LOW CHEMICAL  
EMISSIONS:  
UL COM/CGG  
UL 2818



**Childcraft® Step Stool**

This one-step unit includes non-skid strips for safety. Assembled.



Item #	Description	Product Dimensions	Number of Steps	List Price
5-1491164-670	Step Stool	23 W x 11-3/4 D x 6 H in	1	\$142.95



**Quiet Divider Colors**



Blueberry

Slate Blue

Natural Tan

**Angeles® Sound Sponge® Quiet Dividers®**

Flexible room dividers help create separation of space with multiple configurations. Amazingly sound absorbent, lightweight, and easy to maneuver. Includes 2 low-profile support feet with glides for easy movement along the bottom edge. Hook and loop compatible; magnetic connectors easily join panels. Easy to clean with standard carpet cleaner. To store, just roll dividers up with included security strap. 3-year warranty. Available in 4 sizes and 3 colors: blueberry, slate blue, or natural tan. Please specify color choice when ordering.

Item #	Description	Product Dimensions	Color	List Price
5-1435558-670	Wall Divider	72 W x 3 D X 30 H in	Specify	\$845.95
5-1435560-670	Wall Divider	72 W x 3 D X 48 H in	Specify	\$1,131.95
5-1435559-670	Wall Divider	120 W x 3 D x 30 H in	Specify	\$1,158.95
5-1435561-670	Wall Divider	120 W x 3 D x 48 H in	Specify	\$1,758.95
5-1435563-670	Corner Post	2 W x 2 D x 30 H in	Black	\$202.95
5-1435562-670	Support Feet - Set of 2	18 W x 2 D x 13 H in	Black	\$129.95
5-1435564-670	Magnetic Wall Strip	3 W x 28 H in	White	\$59.95



Steel Support Feet



Rolls up for compact storage with included security strap



4-Sided Corner Post



Magnetic Wall Strip



ESSENTIALS  
BY MOORECO



PLEASE SPECIFY COLOR CHOICE



Champagne



Cotton



Pacific Blue

**Essentials™ by MooreCo® Preschool Dividers**

Preschool Dividers are the ideal portable panel for any early childhood environment. Use the panels as room dividers, acoustical shields, storyboard displays, or to exhibit artwork. Join dividers together to create private learning areas, or to divide rooms into activity areas. Available in easy to clean vinyl, or melamine dry erase surface. Lightweight panel and wide base design create stability. Black anodized aluminum trim. Panels include 2" casters (2 locking).



Item #	Description	Number of Panels	Product Dimensions	Color	List Price
<b>Divider - Two Sided Markerboard</b>					
6-1127881-670	Two Sided Markerboard	1	48 W x 48 H in	White	\$525.95
6-508424-670	Two Sided Markerboard	1	60 W x 48 H in	White	\$821.95
6-508427-670	Two Sided Markerboard	1	72 W x 48 H in	White	\$1,254.95
<b>Divider - Two Sided Vinyl</b>					
6-1442400-670	Two Sided Vinyl	1	48 W x 48 H in	Specify	\$674.95
6-1442404-670	Two Sided Vinyl	1	60 W x 48 H in	Specify	\$690.95
6-1442408-670	Two Sided Vinyl	1	72 W x 48 H in	Specify	\$783.95
<b>Divider - Two Sided Markerboard/Vinyl</b>					
6-1442402-670	Two Sided Markerboard/Vinyl	1	48 W x 48 H in	Specify	\$718.95
6-1442406-670	Two Sided Markerboard/Vinyl	1	60 W x 48 H in	Specify	\$864.95
6-1442410-670	Two Sided Markerboard/Vinyl	1	72 W x 48 H in	Specify	\$1,013.95

**Children's Factory® Big Screen Panels**

These panels can serve a variety of purposes in any classroom, preschool, or nursery. Great for creating a quiet space for rest time, building discovery, activity centers, and dividing rooms. Panels are durable and easy-to-clean. Double claws create flexible hinges to link panels together and allow for foldable storage. Panels can be used horizontally or vertically and each panel measures 47-1/2"W x 59-1/2"H. Set includes molded, weighted, plastic cantilever legs to ensure stability. Order one set of PlayPanel cantilever legs for every 3 single panels. Single panel is available in blue, green, yellow, or red please specify color when ordering.

Item #	Description	Product Dimensions	Color	List Price
5-2049193-670	Big Screen PlayPanel Set of 4	47-1/2"W x 1-1/4"D x 59-1/2"H in	Clear	\$905.95
5-1353302-670	Big Screen PlayPanel Set of 4	47-1/2"W x 1-1/4"D x 59-1/2"H in	Rainbow	\$860.95
5-2049190-670	Single Big Screen PlayPanel	47-1/2"W x 1-1/4"D x 59-1/2"H in	Clear	\$269.95
5-5004738-670	Single Big Screen PlayPanel	47-1/2"W x 1-1/4"D x 59-1/2"H in	Specify	\$241.95
9-1136860-670	Cantilever Legs Set of 2	1-1/2 W x 16 D x 9 H in	Blue	\$94.95



Clear 4 Panel Set



Rainbow 4 Panel Set



Alternate loft arrangements using the Single Base Loft components



**CHILDCRAFT®**  
A School Specialty Exclusive

ASSEMBLED IN U.S.A.  
WITH GLOBAL MATERIALS



PRODUCT CERTIFIED FOR LOW CHEMICAL EMISSIONS: UL.COM/SGG UL 2818



Single Base Extended Height w/Clear Rails

**Childcraft® Lofts**

Lofts are constructed of all-birch panels and solid maple. Steps feature deep 10" treads, high handrails, and clear panels or slats so children are visible. Available in single base option or double base option which has a fully-carpeted top surface. Headroom under standard height loft is 38-5/8" and is 52-5/8"H under extended height loft with overall dimensions of 9' 8" W x 7' 6" D for either. 10' ceiling height recommended for extended height loft. A Loft Height Extending Package is available only for the double base loft and will convert it to an extended height version.

**Assembly required.** Hardware and instructions included.

Item #	Description	Product Height	List Price
<b>Single Base</b>			
6-1571601-670	Standard Height w/Wood Rails	4 ft 8 in	\$7,554.95
6-1571602-670	Standard Height w/Clear Rails	4 ft 8 in	\$7,554.95
6-1571603-670	Extended Height w/Wood Rails	7 ft 4 in	\$8,401.95
6-1571604-670	Extended Height w/Clear Rails	7 ft 4 in	\$8,401.95
<b>Double Base</b>			
6-076654-670	Standard Height w/Wood Rails	6 ft 2 in	\$11,518.95
6-076655-670	Standard Height w/Clear Rails	6 ft 2 in	\$11,518.95
6-076656-670	Extended Height w/Wood Rails	7 ft 4 in	\$13,176.95
6-076657-670	Extended Height w/Clear Rails	7 ft 4 in	\$13,176.95
<b>Loft Extending Kit</b>			
6-296597-670	Loft Height Extending Package	14 in	\$2,613.95

Alternate loft arrangements using the Double Base Loft components

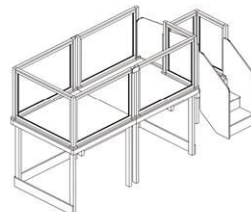
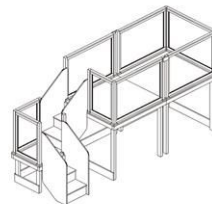
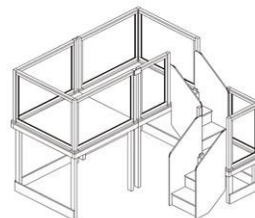

Double Base Standard Height w/Wood Rails





PRODUCT CERTIFIED FOR LOW CHEMICAL EMISSIONS  
UL COMGG  
UL 2818



**Childcraft® Laminate-Top Wood Tables**

Solid maple aprons, sturdy 1-3/4" square maple legs in a clear, natural finish. Woodgrain laminate tops resist paint and crayon marks, wipe clean with cloth or sponge, and can withstand bleach-cleaning. Simple leg assembly required.

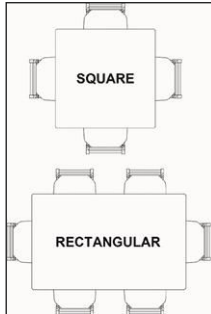
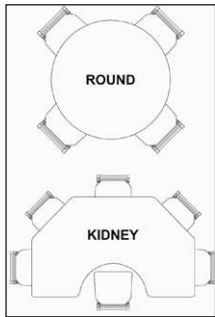

**Round Tables**

Item #	Top Height	List Price
<b>30 in Round</b>		
5-1386533-670	12 in	\$346.95
5-1386534-670	14 in	\$346.95
5-1386535-670	16 in	\$346.95
5-206108-670	18 3/4 in	\$346.95
5-297479-670	20 in	\$346.95
5-1462464-670	22 in	\$346.95
5-297473-670	24 in	\$346.95
5-1473463-670	26 in	\$346.95
5-1473464-670	28 in	\$346.95
5-1473465-670	30 in	\$346.95
<b>36 in Round</b>		
5-206110-670	18 3/4 in	\$442.95
5-297464-670	20 in	\$442.95
5-1473466-670	22 in	\$442.95
5-1473467-670	24 in	\$442.95
5-1473468-670	26 in	\$442.95
5-1473469-670	28 in	\$442.95
5-1473470-670	30 in	\$442.95

**Square Tables**

Item #	Top Height	List Price
<b>24 W x 24 L in</b>		
5-1473458-670	12 in	\$283.95
5-1386531-670	14 in	\$283.95
5-1386532-670	16 in	\$283.95
5-1352456-670	18 3/4 in	\$283.95
5-1337177-670	20 in	\$283.95
5-1337178-670	22 in	\$283.95
5-1337179-670	24 in	\$283.95
5-1337180-670	26 in	\$283.95
5-1337181-670	28 in	\$283.95
5-1337182-670	30 in	\$283.95
<b>30 W x 30 L in</b>		
5-1352457-670	18 3/4 in	\$412.95
5-1337183-670	20 in	\$412.95
5-1337184-670	22 in	\$412.95
5-1337185-670	24 in	\$412.95
5-1337186-670	26 in	\$412.95
5-1337187-670	28 in	\$412.95
5-1337188-670	30 in	\$412.95

**Kidney-Shaped Tables**

Item #	Top Height	List Price
<b>36 W x 58 L in</b>		
5-1473444-670	18 3/4 in	\$798.95
5-1473445-670	20 in	\$798.95
5-1473446-670	22 in	\$798.95
5-296501-670	24 in	\$798.95
5-296492-670	26 in	\$798.95
5-1473447-670	28 in	\$798.95
5-1473448-670	30 in	\$798.95

**Rectangular Tables**

Item #	Top Height	List Price
<b>24 W x 36 L in</b>		
5-296192-670	14 in	\$318.95
5-1473459-670	16 in	\$318.95
5-297515-670	18 3/4 in	\$318.95
5-297512-670	20 in	\$318.95
5-078232-670	22 in	\$318.95
5-297509-670	24 in	\$318.95
5-296111-670	26 in	\$318.95
5-296369-670	28 in	\$318.95
5-296372-670	30 in	\$318.95
<b>24 W x 48 L in</b>		
5-296195-670	14 in	\$403.95
5-1473460-670	16 in	\$403.95
5-297506-670	18 3/4 in	\$403.95
5-297572-670	20 in	\$403.95
5-297503-670	22 in	\$403.95
5-297500-670	24 in	\$403.95
5-296114-670	26 in	\$403.95
5-296375-670	28 in	\$403.95
5-296378-670	30 in	\$403.95
<b>30 W x 48 L in</b>		
5-1388570-670	16 in	\$429.95
5-1473461-670	18 3/4 in	\$429.95
5-297494-670	20 in	\$429.95
5-297491-670	22 in	\$429.95
5-297488-670	24 in	\$429.95
5-297485-670	26 in	\$429.95
5-296381-670	28 in	\$429.95
5-296384-670	30 in	\$429.95
<b>30 W x 60 L in</b>		
5-1473462-670	18 3/4 in	\$634.95
5-1302094-670	20 in	\$634.95
5-1302093-670	22 in	\$634.95
5-1302092-670	24 in	\$634.95
5-1302091-670	26 in	\$634.95
5-1302090-670	28 in	\$634.95
5-1302089-670	30 in	\$634.95
<b>36 W x 48 L in</b>		
5-1352458-670	18 3/4 in	\$634.95
5-1337189-670	20 in	\$634.95
5-1337190-670	22 in	\$634.95
5-1337191-670	24 in	\$634.95
5-1337192-670	26 in	\$634.95
5-1337193-670	28 in	\$634.95
5-1337194-670	30 in	\$634.95



**Solid Hardwood Chairs, Tables, and Sets**

Set of two chairs with properly spaced rails for child safety and hard rubber feet to reduce noise and prevent scratching.

Childcraft® Solid Hardwood tables are constructed with solid aprons and sturdy legs made of maple. Clear, natural cleanable finish can withstand bleach-cleaning. Simple leg assembly required..

Item #	Description	Seat Height	Quantity	List Price
<b>Hardwood Ladderback Chairs</b>				
5-2095345-670	Ladderback Chair	10 in	Set of 2	\$299.95
5-2095347-670	Ladderback Chair	12 in	Set of 2	\$325.95
5-2095348-670	Ladderback Chair	14 in	Set of 2	\$347.95
5-2095346-670	Ladderback Chair	16 in	Set of 2	\$368.95

Item #	Description	Product Dimensions	Top Height	List Price
<b>Childcraft® Solid Hardwood Tables</b>				
5-2028270-670	Square Table	24 Square x 20 H in	20 in	\$335.95
5-2028267-670	Square Table	24 Square x 22 H in	22 in	\$335.95
5-2028269-670	Round Table	30 Round x 20 H in	20 in	\$382.95
5-2028268-670	Round Table	30 Round x 22 H in	22 in	\$382.95

Item #	Description	Product Dimensions	Top Height	Seat Height	List Price
<b>Table and Chair Sets</b>					
5-2027799-670	Square Table & 2 Chair Set	24 Square x 20 H in	20 in	12 in	\$628.95
5-2027798-670	Square Table & 2 Chair Set	24 Square x 22 H in	22 in	14 in	\$649.95
5-2027797-670	Round Table & 2 Chair Set	30 Round x 20 H in	20 in	12 in	\$672.95
5-2027796-670	Round Table & 2 Chair Set	30 Round x 22 H in	22 in	14 in	\$693.95



PRODUCT CERTIFIED FOR LOW CHEMICAL EMISSIONS: UL COMGG UL 2818



**Childcraft® Student Reading Carrel**

Semi-private carrel is available in a range of leg/top heights. Simple leg assembly required.



**Childcraft® 48" x 36" Library/Classroom Table/Desk**

Laminate top table with solid maple apron and legs includes four undermount storage openings that measure approximately 14-3/4"W x 13"D x 3-3/8"H. Simple leg assembly required.



Item #	Description	Product Dimensions	Top Height	List Price
5-1357857-670	Student Carrell	25-3/4 Wx19-3/4 Dx31-3/4 H in	18-3/4 in	\$587.95
5-1357858-670	Student Carrell	25-3/4 W x 19-3/4 D x 33 H in	20 in	\$587.95
5-1357859-670	Student Carrell	25-3/4 W x 19-3/4 D x 35 H in	22 in	\$587.95
5-1357860-670	Student Carrell	25-3/4 W x 19-3/4 D x 37 H in	24 in	\$587.95
5-1357845-670	Student Carrell	25-3/4 W x 19-3/4 D x 39 H in	26 in	\$587.95
5-1473449-670	Student Carrell	25-3/4 W x 19-3/4 D x 41 H in	28 in	\$587.95
5-1473479-670	Student Carrell	25-3/4 W x 19-3/4 D x 43 H in	30 in	\$587.95

Item #	Top Height	List Price
5-078168-670	22 in	\$687.95
5-078169-670	24 in	\$687.95
5-078170-670	26 in	\$687.95
5-078171-670	28 in	\$687.95
5-078172-670	30 in	\$687.95

**Childcraft® Adjustable Toddler Tables and Stacking Toddler Chairs**

Table is 35-3/4" square with four cutouts to define personal space and allow toddlers to sit close-up. Adjusts to three heights: 14", 16-1/2" and 19". Simple assembly required. Hardware and instructions included. Stackable chairs feature smooth edges and rounded corners. Unique design allows chairs to stack vertically and locks them in place for safety. Assembled.



Stackable chairs feature smooth edges and rounded corners.

Item #	Description	Seat Height	Quantity	List Price
<b>Chairs</b>				
5-1320384-670	Stacking Toddler Chair	5 in	Each	\$106.95
5-1320385-670	Stacking Toddler Chair	7 in	Each	\$113.95
5-1320386-670	Stacking Toddler Chair	9 in	Each	\$123.95

Item #	Description	Product Dimensions	Top Height	List Price
5-1464145-670	Toddler Blossom Table	35-3/4 W x 35-3/4 D in	14-19 in	\$559.95

Item #	Description	Product Dimensions	Top Height	Seat Height	Quantity	List Price
5-1468523-670	Blossom Table & 4 Chairs	35-3/4 W x 35-3/4 D in	14-19 in	7 in	Set of 5	\$984.95



PLEASE SPECIFY COLOR CHOICE

Refer to pages 60-61 for color options.



PRODUCT CERTIFIED FOR LOW CHEMICAL EMISSIONS  
UL.COM/GG  
UL 2818

CLASSROOM SELECT



Ball Glides

Adjustable Height Chair Dolly



Black Frame

### Classroom Select® Contemporary Chair with Ball Glides

Ergonomic soft plastic chair is shaped to offer upper back and lumbar support, with side-to-side flexibility that adjusts to a variety of body profiles. Progressive waterfall front seat edge provides comfort and support. Unique design prevents shifting or leaning when stacked. Frames are 1-1/8" 18-gauge tubular steel and feature colored ball glides to match the chair shell. Assembled. **Please order a minimum of 4.**

Item #	Seat Height	Seat and Back Color	Frame Color	List Price
6-1415413-670	16 in	Specify	Chrome	\$92.95
6-1425929-670	16 in	Specify	Black	\$86.95
6-1415412-670	16 in	Specify	Matching	\$86.95
6-1415411-670	14 in	Specify	Chrome	\$88.95
6-1425928-670	14 in	Specify	Black	\$82.95
6-1415410-670	14 in	Specify	Matching	\$82.95
6-1415409-670	12 in	Specify	Chrome	\$86.95
6-1425927-670	12 in	Specify	Black	\$79.95
6-1415408-670	12 in	Specify	Matching	\$79.95
6-1415407-670	10 in	Specify	Chrome	\$83.95
6-1425926-670	10 in	Specify	Black	\$76.95
6-1415406-670	10 in	Specify	Matching	\$76.95
6-1415405-670	8 in	Specify	Chrome	\$82.95
6-1425925-670	8 in	Specify	Black	\$75.95
6-1415404-670	8 in	Specify	Matching	\$75.95

Item #	Description	List Price
6-1496629-670	Adjustable Height Chair Dolly	\$286.95

### Classroom Select® NeoRok® Stool

The ability to move in an environment is proven to enhance learning, concentration, and attentiveness. With a unique rounded base design, this motion seating solution allows students to rock and tilt in all directions. The lightweight polypropylene stool is easy to transport and is the perfect fit for your interactive classroom. Assembled. **Quickship available in all sizes in your choice of Cardinal (Red), Tangerine, Lime, Marine (Royal Blue), Imperial (Navy Blue) or Ebony (Black).**



Item #	Seat Height	List Price
5-1546367-670	20-1/2 in	\$112.95
5-1546366-670	18-1/2 in	\$106.95
5-1496633-670	15-1/2 in	\$99.95
5-1496631-670	12-1/2 in	\$92.95

**24-hr Quickship** available for items 1546366 and 1496633 with Marine (Royal Blue) frame color in quantities up to 45 each. Applies to orders containing 24 hour quick ship items only.

### Classroom Select® Contemporary Four Leg Chair

Well-fitting, ergonomic chair with tubular steel frame is designed to offer upper back and lumbar support, with side-to-side flexibility that adjusts to a variety of body profiles. Available in various sizes, plus an extra wide A+ XL seat with a 30% larger surface area than the standard 18" chair. The unique design prevents shifting or leaning when stacked. The legs are 1-1/8" 18-gauge tubular steel (16-gauge for 18" A+ and 20" A+) and feature full nickel chrome or black powdercoat frame. Four self-leveling glide options. Powdercoat matching frame color available in smaller chair shell sizes. Optional field installed book basket available for 20" A+, 18" A+ and 18" chairs. Assembled. **Please order a minimum of four chairs.**

**Quickship available in 10", 12", 14", 16", 18" and 18" A+ seat heights, with chrome frame, nylon glides and your choice of Marine (Royal Blue), Imperial (Navy Blue) or Ebony (Black) seat colors.**

Item #	Seat Height	Seat and Back Color	Fabric Color	Frame Color	Glide/Caster Type	List Price
6-1444516-670	20 in A+	Specify	Specify	Chrome	Specify	\$166.95
6-1444517-670	20 in A+	Specify	Specify	Black	Specify	\$159.95
6-1441232-670	20 in A+	Specify	-	Chrome	Specify	\$99.95
6-1441233-670	20 in A+	Specify	-	Black	Specify	\$92.95
6-1441240-670	18 in A+	Specify	Specify	Chrome	Specify	\$159.95
6-1441241-670	18 in A+	Specify	Specify	Black	Specify	\$152.95
6-1357322-670	18 in A+	Specify	-	Chrome	Specify	\$92.95
6-1395298-670	18 in A+	Specify	-	Black	Specify	\$86.95
6-1441242-670	18 in	Specify	Specify	Chrome	Specify	\$152.95
6-1441243-670	18 in	Specify	Specify	Black	Specify	\$146.95
6-1357323-670	18 in	Specify	-	Chrome	Specify	\$86.95
6-1395299-670	18 in	Specify	-	Black	Specify	\$79.95
6-1357324-670	16 in	Specify	-	Chrome	Specify	\$79.95
6-1395305-670	16 in	Specify	-	Black	Specify	\$72.95
6-1426053-670	16 in	Specify	-	Matching	Specify	\$72.95
6-1357325-670	14 in	Specify	-	Chrome	Specify	\$75.95
6-1395306-670	14 in	Specify	-	Black	Specify	\$68.95
6-1426052-670	14 in	Specify	-	Matching	Specify	\$68.95
6-1357326-670	12 in	Specify	-	Chrome	Specify	\$72.95
6-1395307-670	12 in	Specify	-	Black	Specify	\$66.95
6-1426051-670	12 in	Specify	-	Matching	Specify	\$66.95
6-1395296-670	10 in	Specify	-	Chrome	Specify	\$70.95
6-1395308-670	10 in	Specify	-	Black	Specify	\$63.95
6-1426050-670	10 in	Specify	-	Matching	Specify	\$63.95
6-1395297-670	8 in	Specify	-	Chrome	Specify	\$68.95
6-1395309-670	8 in	Specify	-	Black	Specify	\$62.95
6-1426048-670	8 in	Specify	-	Matching	Specify	\$62.95

Item #	Description	List Price
9-1362136-670	Chrome Wire Book Basket	\$22.95
9-1441266-670	Black Wire Book Basket	\$22.95
6-1496629-670	Adjustable Height Chair Dolly	\$286.95

**24-hr Quickship** available for items 1357323, 1357324, 1357325 and 1357326 with Imperial (Navy Blue) or Marine (Royal Blue) seat colors and nylon glides in quantities up to 100 each. Applies to orders containing 24 hour quick ship items only.



**CLASSROOM SELECT**



PRODUCT CERTIFIED FOR LOW CHEMICAL EMISSIONS: UL.COM/IGG UL 2818



PLEASE SPECIFY COLOR CHOICE

Refer to pages 60-61 for color options.

**Classroom Select® Royal Seating® 1100 Chair with Ball Glides**

Designed to promote correct seating posture, the v-back shell provides a comfortable seating option for any classroom. Choose chrome metal, black finish, or matching color frame. Features durable ball glides that are ideal for a variety of flooring options and are matched to your seat color choice. Stacks 10-12 chairs high for convenient storage. Assembled. **Please order a minimum of 4.**

Item #	Seat Height	Seat and Back Color	Frame Color	List Price
6-1478916-670	16 in	Specify	Chrome	\$92.95
6-1478184-670	16 in	Specify	Black	\$86.95
6-1477480-670	16 in	Specify	Matching	\$86.95
6-1458244-670	14 in	Specify	Chrome	\$88.95
6-1478182-670	14 in	Specify	Black	\$82.95
6-1458245-670	14 in	Specify	Matching	\$82.95
6-1458242-670	12 in	Specify	Chrome	\$86.95
6-1478181-670	12 in	Specify	Black	\$79.95
6-1458243-670	12 in	Specify	Matching	\$79.95
6-1458240-670	10 in	Specify	Chrome	\$84.95
6-1478180-670	10 in	Specify	Black	\$78.95
6-1458241-670	10 in	Specify	Matching	\$78.95
6-1478179-670	8 in	Specify	Chrome	\$83.95
6-1476997-670	8 in	Specify	Black	\$76.95
6-1477001-670	8 in	Specify	Matching	\$76.95

Item #	Description	List Price
6-1496629-670	Adjustable Height Chair Dolly	\$286.95

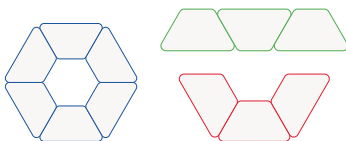

**Classroom Select® Royal Seating® Prima Learning Circle Desk**

Enhance student participation and group learning with colorful, flexible seating! The trapezoid-shaped desk offers flexible seating solutions to suit any environment. Use desks alone or in a number of multiple-desk configurations for group learning. Desktops measure 20" x 15" x 32" and come with 1-1/8" gray nebula laminate top. Choose a black frame with your choice of T-Mold edge color, or colored frame with matching vinyl T-Mold edging. Legs adjust from 19" to 30". Please specify color choice when ordering.

Item #	Product Dimensions	Edge Color	Frame Color	Top Color	List Price
6-336185-670	15 x 20 x 32 in	Matching	Specify	Gray Nebula	\$309.95
6-1481452-670	15 x 20 x 32 in	Specify	Black	Gray Nebula	\$309.95

**Prima Learning Circle Edge and Leg Color Choices**

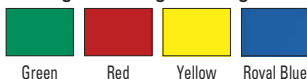

**Classroom Select® Royal Seating® Prima Stack Chair**

Students love these lightweight colorful chairs! All plastic chair seat and frame permanently heat welded for strength and durability. Seat color available with black or matching leg color. Limited lifetime warranty. Please specify seat color and frame color when ordering.

**Please order in quantities of 4.**

Item #	Seat Height	Seat Color	Frame Color	List Price
5-318793-670	13 in	Specify	Specify	\$72.95
5-318790-670	12 in	Specify	Specify	\$72.95
5-318787-670	11 in	Specify	Specify	\$72.95
5-318784-670	10 in	Specify	Specify	\$72.95
5-318799-670	9 in	Specify	Specify	\$72.95
5-318796-670	8 in	Specify	Specify	\$72.95

PLEASE SPECIFY COLOR CHOICE



**Classroom Select® Royal Seating® 2900 Prima Table**

Colorful Prima Tables complete a dramatic play area or can offer extra work space in early childhood classrooms. 5/8" thick tops with black, vinyl edge banding and black legs. Lifetime limited warranty. Available in either 18" or 21" heights. Please specify laminate top color choice when ordering.

Item #	Top Shape	Product Dimensions	Top Color	List Price
5-1458274-670	Rectangle	20 x 30 x 18 H in	Specify	\$166.95
5-1458275-670	Rectangle	20 x 30 x 21 H in	Specify	\$166.95
5-1458276-670	Round	30 x 18 H in	Specify	\$181.95
5-1458277-670	Round	30 x 21 H in	Specify	\$181.95

**2900 Prima Table Top Color Choices**

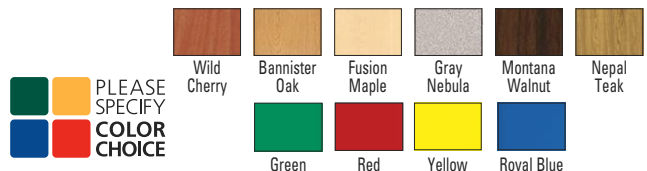



PRODUCT CERTIFIED FOR LOW CHEMICAL EMISSIONS: UL.COM/GG UL 2818



### Classroom Select® T-Mold Activity Table with Standard Legs

Our most popular classroom table offers a wide variety of sizes, laminate colors, T-Mold edge banding, and upper leg colors. Tables have a 1-1/8" particleboard core with high pressure laminate top. Tables 60" or longer have a 20-gauge galvanized steel stretcher bar permanently attached to the underside of the top to prevent sagging. Tables are height adjustable on 1" centers from 22" to 30" or 15" to 25". Available with an optional black metal book box, approximately 15" W x 11" D x 4-1/2" H, sold separately. Easy to install tote rail system available for your storage needs, sold separately. **Quickship available for indicated shapes and sizes in Bannister Oak, Gray Nebula, Fusion Maple, Nepal Teak, or Royal Blue laminate, with Black or Titanium edge in your choice of any leg height and color.**

**24-hr Quickship** available for items 1334849, 1334853 and 1334851 with Gray Nebula or Bannister Oak Tops and Black T-mold edge, in your choice of any leg height and color. Quantities not to exceed 10 each. Applies to orders containing 24 hr quickship items only.



Item #	Top Shape	Product Dimensions	Product Height	Top Color	Edge Color	Leg Color	List Price
<b>T-Mold Edge</b>							
6-1334848-670	Rectangle	36 W x 24 D in	Specify	Specify	Specify	Specify	\$199.95
6-1334849-670	Rectangle	48 W x 24 D in	Specify	Specify	Specify	Specify	\$232.95
6-1334850-670	Rectangle	60 W x 24 D in	Specify	Specify	Specify	Specify	\$266.95
6-1457635-670	Rectangle	72 W x 24 D in	Specify	Specify	Specify	Specify	\$299.95
6-1334852-670	Rectangle	48 W x 30 D in	Specify	Specify	Specify	Specify	\$252.95
6-1334853-670	Rectangle	60 W x 30 D in	Specify	Specify	Specify	Specify	\$279.95
6-1334854-670	Rectangle	72 W x 30 D in	Specify	Specify	Specify	Specify	\$306.95
6-1457636-670	Rectangle	84 W x 30 D in	Specify	Specify	Specify	Specify	\$332.95
6-1457637-670	Rectangle	96 W x 30 D in	Specify	Specify	Specify	Specify	\$359.95
6-1334857-670	Rectangle	60 W x 36 D in	Specify	Specify	Specify	Specify	\$306.95
6-1334858-670	Rectangle	72 W x 36 D in	Specify	Specify	Specify	Specify	\$332.95
6-1334860-670	Rectangle	60 W x 42 D in	Specify	Specify	Specify	Specify	\$332.95
6-1334855-670	Round	36 in	Specify	Specify	Specify	Specify	\$226.95
6-1334859-670	Round	42 in	Specify	Specify	Specify	Specify	\$252.95

Item #	Top Shape	Product Dimensions	Product Height	Top Color	Edge Color	Leg Color	List Price
6-1334862-670	Round	48 in	Specify	Specify	Specify	Specify	\$279.95
6-1334867-670	Round	60 in	Specify	Specify	Specify	Specify	\$332.95
6-1334856-670	Square	36 W x 36 D in	Specify	Specify	Specify	Specify	\$226.95
6-1457638-670	Square	42 W x 42 D in	Specify	Specify	Specify	Specify	\$252.95
6-1334863-670	Square	48 W x 48 D in	Specify	Specify	Specify	Specify	\$279.95
6-1334847-670	Trapezoid	48 W x 24 D in	Specify	Specify	Specify	Specify	\$226.95
6-1334851-670	Trapezoid	60 W x 30 D in	Specify	Specify	Specify	Specify	\$252.95
6-1334865-670	Kidney	72 W x 48 D in	Specify	Specify	Specify	Specify	\$412.95
6-1457639-670	Kidney	96 W x 48 D in	Specify	Specify	Specify	Specify	\$439.95
6-1334864-670	Horseshoe	72 W x 48 D in	Specify	Specify	Specify	Specify	\$412.95
6-1334868-670	Horseshoe	60 W x 66 D in	Specify	Specify	Specify	Specify	\$439.95
6-1334861-670	Clover	48 W x 48 D in	Specify	Specify	Specify	Specify	\$306.95
6-1334866-670	Flower	60 W x 60 D in	Specify	Specify	Specify	Specify	\$386.95
6-5004576-670	Half-Moon	72 W x 36 D in	Specify	Specify	Specify	Specify	\$332.95

Item #	Description	List Price
9-1547618-670	Activity Table Book Box	\$27.95
Item #	Description	List Price
9-2104262-670	Rail Kit with Clear Tote	\$92.95

### More Shapes and Options Available Online

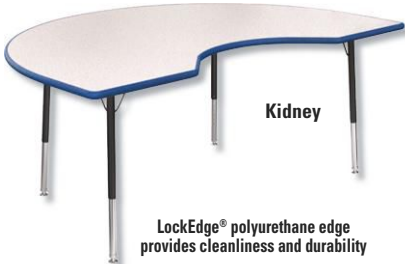

### Classroom Select® LockEdge® Activity Table with Standard Legs

Cafeterias, libraries, and meeting rooms all require tables in different sizes, colors, shapes, and heights. Tops are constructed of a 1-1/8" MDF core with high pressure laminate surface, balanced with a phenolic resin backer sheet. The top is finished with a colored LockEdge® and black upper frame. Chrome leg inserts create tables that are height adjustable on 1" centers from 22" to 30" or 15" to 24". Available with an optional black metal book box, approximately 15" W x 11" D x 4-1/2" H, sold separately. Various caster options available upon special request. **Quickship available for indicated shapes and sizes in Bannister Oak, Gray Nebula, Fusion Maple, Nepal Teak, or Royal Blue laminate, in your choice of any leg height and color.**

Item #	Top Shape	Product Dimensions	Product Height	Top Color	Edge Color	Leg Color	List Price
<b>LockEdge®</b>							
6-1362565-670	Rectangle	36 W x 24 D in	Specify	Specify	Specify	Specify	\$299.95
6-1362566-670	Rectangle	48 W x 24 D in	Specify	Specify	Specify	Specify	\$332.95
6-1362568-670	Rectangle	60 W x 24 D in	Specify	Specify	Specify	Specify	\$366.95
6-1362569-670	Rectangle	72 W x 24 D in	Specify	Specify	Specify	Specify	\$399.95
6-1362570-670	Rectangle	48 W x 30 D in	Specify	Specify	Specify	Specify	\$352.95
6-1362571-670	Rectangle	60 W x 30 D in	Specify	Specify	Specify	Specify	\$379.95
6-1362573-670	Rectangle	72 W x 30 D in	Specify	Specify	Specify	Specify	\$406.95
6-1362574-670	Rectangle	84 W x 30 D in	Specify	Specify	Specify	Specify	\$432.95
6-1362575-670	Rectangle	96 W x 30 D in	Specify	Specify	Specify	Specify	\$459.95
6-1362577-670	Rectangle	60 W x 36 D in	Specify	Specify	Specify	Specify	\$406.95
6-1362578-670	Rectangle	72 W x 36 D in	Specify	Specify	Specify	Specify	\$432.95
6-1362581-670	Rectangle	60 W x 42 D in	Specify	Specify	Specify	Specify	\$432.95
6-1362579-670	Round	36 in	Specify	Specify	Specify	Specify	\$326.95
6-1362582-670	Round	42 in	Specify	Specify	Specify	Specify	\$352.95

Item #	Top Shape	Product Dimensions	Product Height	Top Color	Edge Color	Leg Color	List Price
6-1362586-670	Round	48 in	Specify	Specify	Specify	Specify	\$379.95
6-1362589-670	Round	60 in	Specify	Specify	Specify	Specify	\$432.95
6-1362576-670	Square	36 W x 36 D in	Specify	Specify	Specify	Specify	\$326.95
6-1362580-670	Square	42 W x 42 D in	Specify	Specify	Specify	Specify	\$352.95
6-1362583-670	Square	48 W x 48 D in	Specify	Specify	Specify	Specify	\$379.95
6-1362567-670	Trapezoid	48 W x 24 D in	Specify	Specify	Specify	Specify	\$326.95
6-1362572-670	Trapezoid	60 W x 30 D in	Specify	Specify	Specify	Specify	\$352.95
6-1362834-670	Kidney	72 W x 48 D in	Specify	Specify	Specify	Specify	\$512.95
6-1362584-670	Kidney	96 W x 48 D in	Specify	Specify	Specify	Specify	\$539.95
6-1457640-670	Horseshoe	72 W x 48 D in	Specify	Specify	Specify	Specify	\$512.95
6-1362587-670	Horseshoe	60 W x 66 D in	Specify	Specify	Specify	Specify	\$539.95
6-1362585-670	Clover	48 W x 48 D in	Specify	Specify	Specify	Specify	\$406.95
6-1362588-670	Flower	60 W x 60 D in	Specify	Specify	Specify	Specify	\$486.95
6-5004577-670	Half-Moon	72 W x 36 D in	Specify	Specify	Specify	Specify	\$432.95

Item #	Description	List Price
9-1547618-670	Activity Table Book Box	\$27.95





PRODUCT CERTIFIED FOR LOW CHEMICAL EMISSIONS: UL COMPGG UL 2818



Refer to pages 60-61 for color options.

**Classroom Select® Activity Table with Apollo® Legs**

Combining contemporary looks, functionality, and flexibility creates an ideal learning environment for student collaboration and interaction. Featuring the Apollo® leg, designed with 2" round, 17-gauge steel, available in 11" to 17", 15" to 25", and 22" to 30" adjustable height ranges and a variety of colors. Table legs come standard with nylon glides. Table tops are constructed from a 1-1/8" particleboard core with a high pressure laminate surface. Tables 60" or longer have a 20-gauge steel stretcher bar underneath the top for added structural strength to prevent sagging. A quick-set leg system offers easy installation and assembly. Available with an optional black metal book box, approximately 15" W x 11" D x 4-1/2" H, sold separately. Also add the Classroom Select® Technology Basket for a simple storage solution for up to 14" laptops or tablets. Easy to install tote rail system available for your storage needs. Locking caster options available. **Quickship available for indicated shapes and sizes in laminate colors of Bannister Oak, Gray Nebula, Fusion Maple, Nepal Teak, Royal Blue, or Markerboard with Black or Titanium T-Mold edge, or Black LockEdge® in your choice of any leg height and color.**



Features 2" round, 17-gauge steel Apollo legs

**24-hr Quickship** available for items 1496659, 1496663 and 1496678 with Gray Nebula or Bannister Oak Tops and Black T-mold edge, in your choice of any leg height and color. Quantities not to exceed 10 each. Applies to orders containing 24 hr quickship items only.

Item #	Top Shape	Product Dimensions	Product Height	Top Color	Edge Color	Leg Color	List Price
<b>T-Mold Edge</b>							
6-1496658-670	Rectangle	36 W x 24 D in	Specify	Specify	Specify	Specify	\$246.95
6-1496659-670	Rectangle	48 W x 24 D in	Specify	Specify	Specify	Specify	\$279.95
6-1496660-670	Rectangle	60 W x 24 D in	Specify	Specify	Specify	Specify	\$312.95
6-1496661-670	Rectangle	72 W x 24 D in	Specify	Specify	Specify	Specify	\$346.95
6-1496662-670	Rectangle	48 W x 30 D in	Specify	Specify	Specify	Specify	\$299.95
6-1496663-670	Rectangle	60 W x 30 D in	Specify	Specify	Specify	Specify	\$326.95
6-1496664-670	Rectangle	72 W x 30 D in	Specify	Specify	Specify	Specify	\$352.95
6-1496665-670	Rectangle	84 W x 30 D in	Specify	Specify	Specify	Specify	\$379.95
6-1496666-670	Rectangle	96 W x 30 D in	Specify	Specify	Specify	Specify	\$406.95
6-1496667-670	Rectangle	60 W x 36 D in	Specify	Specify	Specify	Specify	\$352.95
6-1496668-670	Rectangle	72 W x 36 D in	Specify	Specify	Specify	Specify	\$379.95
6-1496669-670	Rectangle	60 W x 42 D in	Specify	Specify	Specify	Specify	\$379.95
6-1496670-670	Round	36 Dia in	Specify	Specify	Specify	Specify	\$272.95
6-1496671-670	Round	42 Dia in	Specify	Specify	Specify	Specify	\$299.95
6-1496672-670	Round	48 Dia in	Specify	Specify	Specify	Specify	\$326.95

Item #	Top Shape	Product Dimensions	Product Height	Top Color	Edge Color	Leg Color	List Price
6-1496673-670	Round	60 Dia in	Specify	Specify	Specify	Specify	\$379.95
6-1496674-670	Square	36 W x 36 D in	Specify	Specify	Specify	Specify	\$272.95
6-1496675-670	Square	42 W x 42 D in	Specify	Specify	Specify	Specify	\$299.95
6-1496676-670	Square	48 W x 48 D in	Specify	Specify	Specify	Specify	\$326.95
6-1496677-670	Trapezoid	48 W x 24 D in	Specify	Specify	Specify	Specify	\$272.95
6-1496678-670	Trapezoid	60 W x 30 D in	Specify	Specify	Specify	Specify	\$299.95
6-1496679-670	Kidney	72 W x 48 D in	Specify	Specify	Specify	Specify	\$459.95
6-1496680-670	Kidney	96 W x 48 D in	Specify	Specify	Specify	Specify	\$486.95
6-1496681-670	Horseshoe	48 W x 72 D in	Specify	Specify	Specify	Specify	\$459.95
6-1496682-670	Horseshoe	60 W x 66 D in	Specify	Specify	Specify	Specify	\$486.95
6-1496683-670	Clover	48 Dia in	Specify	Specify	Specify	Specify	\$352.95
6-1496684-670	Flower	60 Dia in	Specify	Specify	Specify	Specify	\$432.95
6-5004580-670	Half-Moon	72W x36D	Specify	Specify	Specify	Specify	\$379.95
6-5008738-670	Half-Round	60 W x 30 D	Specify	Specify	Specify	Specify	\$352.95
6-5008761-670	Media	72 W x 48 D	Specify	Specify	Specify	Specify	\$459.95
6-5008764-670	Zoom	48 W x 48 D	Specify	Specify	Specify	Specify	\$326.95

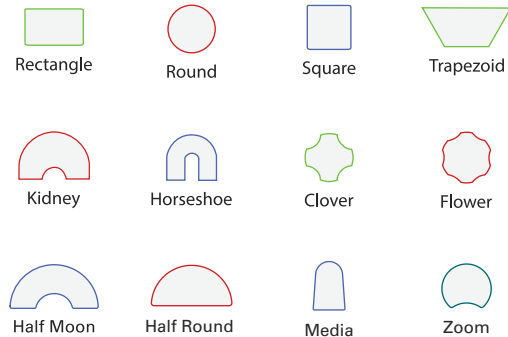

Item #	Top Shape	Product Dimensions	Product Height	Top Color	Edge Color	Leg Color	List Price
<b>LockEdge</b>							
6-1496685-670	Rectangle	36 W x 24 D in	Specify	Specify	Specify	Specify	\$346.95
6-1496686-670	Rectangle	48 W x 24 D in	Specify	Specify	Specify	Specify	\$379.95
6-1496687-670	Rectangle	60 W x 24 D in	Specify	Specify	Specify	Specify	\$412.95
6-1496688-670	Rectangle	72 W x 24 D in	Specify	Specify	Specify	Specify	\$446.95
6-1496689-670	Rectangle	48 W x 30 D in	Specify	Specify	Specify	Specify	\$399.95
6-1496690-670	Rectangle	60 W x 30 D in	Specify	Specify	Specify	Specify	\$426.95
6-1496691-670	Rectangle	72 W x 30 D in	Specify	Specify	Specify	Specify	\$452.95
6-1496692-670	Rectangle	84 W x 30 D in	Specify	Specify	Specify	Specify	\$479.95
6-1496693-670	Rectangle	96 W x 30 D in	Specify	Specify	Specify	Specify	\$506.95
6-1496694-670	Rectangle	60 W x 36 D in	Specify	Specify	Specify	Specify	\$452.95
6-1496695-670	Rectangle	72 W x 36 D in	Specify	Specify	Specify	Specify	\$479.95
6-1496696-670	Rectangle	60 W x 42 D in	Specify	Specify	Specify	Specify	\$479.95
6-1496697-670	Round	36 Dia in	Specify	Specify	Specify	Specify	\$372.95
6-1496698-670	Round	42 Dia in	Specify	Specify	Specify	Specify	\$399.95
6-1496699-670	Round	48 Dia in	Specify	Specify	Specify	Specify	\$426.95

Item #	Top Shape	Product Dimensions	Product Height	Top Color	Edge Color	Leg Color	List Price
6-1496700-670	Round	60 Dia in	Specify	Specify	Specify	Specify	\$479.95
6-1496701-670	Square	36 W x 36 D in	Specify	Specify	Specify	Specify	\$372.95
6-1496702-670	Square	42 W x 42 D in	Specify	Specify	Specify	Specify	\$399.95
6-1496703-670	Square	48 W x 48 D in	Specify	Specify	Specify	Specify	\$426.95
6-1496704-670	Trapezoid	48 W x 24 D in	Specify	Specify	Specify	Specify	\$372.95
6-1496705-670	Trapezoid	60 W x 30 D in	Specify	Specify	Specify	Specify	\$399.95
6-1496706-670	Kidney	72 W x 48 D in	Specify	Specify	Specify	Specify	\$559.95
6-1496707-670	Kidney	96 W x 48 D in	Specify	Specify	Specify	Specify	\$586.95
6-1496708-670	Horseshoe	48 W x 72 D in	Specify	Specify	Specify	Specify	\$559.95
6-1496709-670	Horseshoe	60 W x 66 D in	Specify	Specify	Specify	Specify	\$586.95
6-1496710-670	Clover	48 W x 48 D in	Specify	Specify	Specify	Specify	\$452.95
6-1496711-670	Flower	60 W x 60 D in	Specify	Specify	Specify	Specify	\$532.95
6-5004581-670	Half-Moon	72W x36D	Specify	Specify	Specify	Specify	\$479.95
6-5008741-670	Half-Round	60 W x 30 D	Specify	Specify	Specify	Specify	\$452.95
6-5008749-670	Media	72 W x 48 D	Specify	Specify	Specify	Specify	\$559.95
6-5008754-670	Zoom	48 W x 48 D	Specify	Specify	Specify	Specify	\$426.95





PRODUCT CERTIFIED FOR LOW CHEMICAL EMISSIONS: UL.COM/CGG UL 2818



**CHILDCRAFT®**  
A School Specialty Exclusive



**Childcraft® Family Living Room Center Color**

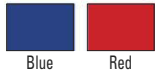

**Childcraft® Family Living Room Center**

Living room furniture set constructed with all wood-ply frames and 3" thick, easy-to-clean vinyl cushions. Seats are 10-1/2" H. Set includes couch, chair, coffee table, and end table.

Item #	Description	Product Dimensions	Color	List Price
6-1353669-670	Living Room Set	-	Blue	\$1,463.95
6-1353668-670	Living Room Set	-	Red	\$1,463.95
5-1352484-670	Couch	35-3/4 W x 20-1/8 D x 20-1/4 H	Blue	\$700.95
5-1352485-670	Couch	35-3/4 W x 20-1/8 D x 20-1/4 H	Red	\$700.95
5-1352486-670	Chair	17-3/4 W x 20-1/8 D x 20-1/4 H	Blue	\$556.95
5-1352487-670	Chair	17-3/4 W x 20-1/8 D x 20-1/4 H	Red	\$556.95
5-271741-670	Coffee Table	29 W x 14-3/4 D x 10-3/8 H in	-	\$161.95
5-1301533-670	End Table	15-3/4 W x 14-3/4 D x 10-3/8 H in	-	\$153.95
5-1539254-670	Replacement Couch Cushions	34-1/2 W x 18 D x 13 H in	Blue	\$420.95
5-1539255-670	Replacement Couch Cushions	34-1/2 W x 18 D x 13 H in	Red	\$420.95
5-1539257-670	Replacement Chair Cushions	16-1/2 W x 18 D x 13 H in	Blue	\$333.95
5-1539258-670	Replacement Chair Cushions	16-1/2 W x 18 D x 13 H in	Red	\$333.95

**CLASSROOM SELECT**

**Classroom Select® Prima Stool**

Invigorate your learning environment with the colorful Prima stool. Constructed with a durable polypropylene seat and welded 14-gauge steel frame, this seating solution is not only affordable, but it is built to last. Featuring a 12-inch seat height, the Prima stool makes a perfect fit for your preschool or kindergarten setting. Stackable up to 10 high for convenient storage when not in use. Purchase in sets of 5, selecting from 5 different color options, or make your classroom pop with the multi-color assorted pack. Assembled.



Item #	Description	Seat Height	List Price
5-2027843-670	Assorted - Set of 5	12 in	\$148.95
5-2027841-670	Red - Set of 5	12 in	\$148.95
5-2027840-670	Green - Set of 5	12 in	\$148.95
5-2027842-670	Beige - Set of 5	12 in	\$148.95
5-2027845-670	Blue - Set of 5	12 in	\$148.95
5-2027844-670	Yellow - Set of 5	12 in	\$148.95



**Califone® Deluxe Soft Rocker**

This rocker provides the perfect seating solution for both kids and adults in classrooms, entertainment rooms, and more. The lightweight chair is finished with an attractive tufting and features a headrest with extra padding for added comfort.

Item #	Description	Product Dimensions	Color	List Price
5-2028336-670	Soft Rocker	28 W x 17-1/2 D x 33-7/8 H in	Red	\$170.95
5-2028337-670	Soft Rocker	28 W x 17-1/2 D x 33-7/8 H in	Blue	\$170.95
5-2028338-670	Soft Rocker	28 W x 17-1/2 D x 33-7/8 H in	Black	\$170.95

**Brand New World Furniture Colors**



Infant/Toddler (Ages 18-36 months)



Preschool (Ages 3-6)

**Brand New World Enviro-Child Upholstery Furniture**

Enviro-Child Upholstery offers early childhood classrooms an eco-friendly and healthier upholstery alternative that is as durable and easy to clean as vinyl. Made of polyurethane, it is PVC free and features an antimicrobial finish. Age-appropriate seat heights. One-year warranty.

Item #	Description	Product Dimensions	Color	List Price
5-1414327-670	Infant/Toddler Chair	22 W x 16 D x 19 H in	Specify	\$333.95
5-1414326-670	Infant/Toddler Sofa	34 W x 16 D x 19 H in	Specify	\$415.95
5-1414329-670	Preschool Chair	26 W x 18 D x 24 H in	Specify	\$378.95
5-1414328-670	Preschool Sofa	38 W x 18 D x 24 H in	Specify	\$440.95

# CHILDCRAFT®

A School Specialty® Exclusive



PRODUCT CERTIFIED FOR LOW CHEMICAL EMISSIONS: UL.COM/IGG UL 2818

PLEASE SPECIFY COLOR CHOICE



A  
C

Square - Blue



E  
G

Round - Green



I  
K

Crescent - Red



M  
N

Curve - Steel Gray

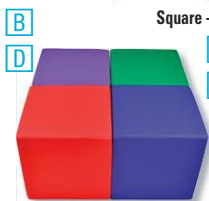

B  
D

Square Set of 4 - Primary



B  
D

Square Set of 4 - Cool Tone



J  
L

Crescent Set of 4 - Primary



J  
L

Crescent Set of 4 - Cool Tone



F  
H

Round Set of 4 - Primary



F  
H

Round Set of 4 - Cool Tone

## Childcraft® Ottomans

Flexible and lightweight soft-seating ottomans are constructed with dense, sturdy foam and cleanable, soft, durable polyurethane material. Available in 12" or 16" H and in multiple color options. Please specify color when ordering.



M  
N

Curve - Red, Blue, Green



M  
N

Curve - Sky Blue

Item #	Description	Product Dimensions	Quantity	Color	List Price
A 5-5004633-670	Square Ottoman	16 W x 16 D x 12 H in	Each	Specify	\$113.95
B 5-5004620-670	Square Ottoman Set of 4	16 W x 16 D x 12 H in	Set of 4	Specify	\$438.95
C 5-5004625-670	Square Ottoman	16 W x 16 D x 16 H in	Each	Specify	\$142.95
D 5-5004624-670	Square Ottoman Set of 4	16 W x 16 D x 16 H in	Set of 4	Specify	\$550.95
E 5-5004617-670	Round Ottoman	16 W x 16 D x 12 H in	Each	Specify	\$121.95
F 5-5004628-670	Round Ottoman Set of 4	16 W x 16 D x 12 H in	Set of 4	Specify	\$468.95
G 5-5004622-670	Round Ottoman	16 W x 16 D x 16 H in	Each	Specify	\$151.95
H 5-5004623-670	Round Ottoman Set of 4	16 W x 16 D x 16 H in	Set of 4	Specify	\$588.95
I 5-5004626-670	Crescent Ottoman	16 W x 14-1/2 D x 12 H in	Each	Specify	\$100.95
J 5-5004616-670	Crescent Ottoman Set of 4	16 W x 14-1/2 D x 12 H in	Set of 4	Specify	\$386.95
K 5-5004630-670	Crescent Ottoman	16 W x 14-1/2 D x 16 H in	Each	Specify	\$122.95
L 5-5004627-670	Crescent Ottoman Set of 4	16 W x 14-1/2 D x 16 H in	Set of 4	Specify	\$472.95
M 5-5004631-670	Curve Ottoman	27 W x 16 D x 12 H in	Each	Specify	\$163.95
N 5-5004619-670	Curve Ottoman	27 W x 16 D x 16 H in	Each	Specify	\$199.95



Cube Chair Tray with Yellow Cube Chair



Set of 4 - Assorted Primary



## Vidget® Flexible Seating System

This unique design provides an active seat, a stool, and a desk in one! Designed to let students safely release energy in order to improve attention and focus, these seats will not tip backward when students rock. Fidgety fingers naturally find the side handles with sensory bumps that provide tactile input to improve calmness. Seats are lightweight, durable, and easy to clean. They also nest to allow for multiple layouts in collaborative spaces and compact storage. Colors vary by size.



## Children's Factory® Cube Chairs

The versatile Cube Chair can be used in a variety of ways. First, use it as a chair with either a 6-inch or a 9-inch high seat. Then flip it over and use it as a 15-inch high table or a seat for adults.

Item #	Description	Product Dimensions	Color	List Price
5-440477-670	Cube Chair - Set of 4	15 W x 15 D x 15 H in	Assorted Primary	\$432.95
5-1327441-670	Cube Chair Tray	26 W x 21-1/8 D x 16-3/8 H in	Blue	\$224.95

Item #	Description	Product Dimensions	Color	List Price
5-1574234-670	Toddler Vidget	11-3/4 Wx15 Dx14-3/4 H in	Specify	\$192.95
5-1574235-670	Small Vidget	14 W x 18 D x 17-1/2 H in	Specify	\$212.95
5-1574236-670	Medium Vidget	15 W x 21 D x 20 H in	Specify	\$252.95
5-1574237-670	Large Vidget	17 W x 24 D x 23-5/16 H in	Specify	\$286.95
5-1574238-670	Teen/Adult Vidget	19 W x 27-3/4 D x 26-5/16 H in	Specify	\$326.95



PRODUCT CERTIFIED FOR LOW CHEMICAL EMISSIONS: UL COM/CGG UL 2818



**CHILDCRAFT®**  
A School Specialty® Exclusive

PLEASE SPECIFY COLOR CHOICE

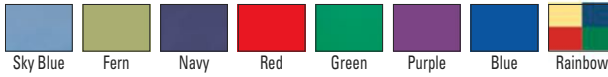

**Childcraft® Premium Round Bean Bag Chair**

Childcraft® Premium Round Bean Bag is lightweight and has a flexible shape that molds to the body's contour and makes it easy to store. All covers have double stitched seams for maximum durability. Cal TB 117-13 Flammability Rating. Specify color.

Item #	Description	Product Dimensions	Color	List Price
5-5003256-670	Junior	26 Dia in	Specify	\$126.95
5-5003288-670	Child	30 Dia in	Specify	\$139.95
5-5003258-670	Adult	35 Dia in	Specify	\$180.95
5-5003255-670	Jumbo	38 Dia in	Specify	\$207.95
5-2027274-670	Refill Bag	-	-	\$57.95



**Childcraft® Premium Highback Bean Bag Chair**

Childcraft® Premium Highback Bean Bag is lightweight and has a flexible shape that molds to the body's contour. All covers have double stitched seams for maximum durability. Cal TB 117-13 Flammability Rating. Specify color.

Item #	Description	Product Dimensions	Color	List Price
5-5003257-670	Child	30 Dia in	Specify	\$173.95
5-5003254-670	Adult	35 Dia in	Specify	\$198.95
5-5003259-670	Jumbo	38 Dia in	Specify	\$225.95
5-2027274-670	Refill Bag	-	-	\$57.95



Set of 6 - Primary



2-1/2" Square  
Set of 4 - Cool Tone

2-1/2" Round  
Set of 6 - Earth Tone

2-1/2" Round  
Set of 6 - Primary

**Childcraft® Round and Square Carry Me Cushions**

Soft, durable floor cushions are cleanable and include a carrying handle. Sets of four or six are available in round or square and two thickness options. 1"H cushions available in Primary colors only. 2-1/2"H cushions available in Primary, Cool Tone, or Earth Tone color options. Specify color.

Item #	Description	Product Dimensions	Quantity	Color	List Price
5-5004613-670	Round Cushions Set of 4	15 W x 15 D x 2-1/2 H in	Set of 4	Specify	\$194.95
5-5004614-670	Square Cushions Set of 4	15 W x 15 D x 2-1/2 H in	Set of 4	Specify	\$194.95
5-5004612-670	Round Cushions Set of 6	15 W x 15 D x 2-1/2 H in	Set of 6	Specify	\$252.95
5-2044707-670	Round Cushions Set of 6	12 W x 12 D x 1 H in	Set of 6	Primary	\$129.95

**Childcraft® Wave Seating Set**

Provide comfy social seating for storytime and group activities. Features soft, durable cover that's easy to wipe clean with a cloth and soapy water. Set of 6 includes Blue, Red, Green, Purple, Orange, and Yellow.

Item #	Description	Product Dimensions	Quantity	Color	List Price
5-2044711-670	Wave Stool Set of 6	9 W x 17-1/2 D x 10 H in	Set of 6	Primary	\$554.95



Primary Set



Earth Tone Set

**Childcraft® Floor Pillow Set**

Set of three oversized pillows with handles are filled with shredded foam for extra comfort. Inner foam is encased in a water and stain resistant cover. Outer pillow covers are removable and constructed from wrinkle resistant polyester that is machine washable and dryable. Available in Primary or Earth Tone color options. Specify color.

Item #	Description	Product Dimensions	Quantity	Color	List Price
5-5004634-670	Floor Pillows Set of 3	27 W x 27 D x 8 H in	Set of 3	Specify	\$384.95



Single Cushion Cart



Double Cushion Cart

**Childcraft® Mobile Cushion Cart**

Mobile storage cart fits round or square cushions up to 15 inches wide. Each side holds up to 20 - 1" H or 10 - 2-1/2" H cushions. Heavy-duty locking casters.

Item #	Description	Product Dimensions	List Price
5-2020829-670	Single Cushion Cart	17-1/2 D x 17-1/2 W x 26 H in	\$417.95
6-2020830-670	Double Cushion Cart	32-3/4 W x 17-1/2 D x 26 H in	\$835.95



**Nap Mat Colors**



**My First Toddler Nap Mat**

This hypoallergenic nap mat features extra firm high-density memory foam for cushioned comfort, a built-in pillow for extra head support, and a removable, machine washable velour cover with ID name tag. Measures 41"L x 21"W x 1"H.

Item #	Description	Quantity	Color	List Price
5-5008523-670	Toddler Nap Mat	Pack of 4	Specify	\$351.95



Cot Sheet



Cotton Blanket

**Cot Sheets and Blankets**

White cot sheet is made from polyester and cotton with elastic loops sewn on all 4 corners. Cot standard sheet size is 51 x 22 inch and cot toddler sheet size is 42 x 23 inch. Designed to fit Childcraft® cots. Don't forget to keep tots comfortable at nap time with a 100% soft cotton double-napped surged blanket. It's extra-long, making it perfect for cots or rest mats. Sheets and blankets are machine washable and dryable.

Item #	Description	Quantity	Color	List Price
<b>Cot Sheets</b>				
9-1363329-670	Toddler Cot Sheet	Each	White	\$21.95
9-2027540-670	Standard Cot Sheet	Each	White	\$23.95
<b>Blankets</b>				
9-1363332-670	Cotton Blanket	Each	White	\$30.95
5-1427750-670	Cotton Blanket	Pack of 12	White	\$332.95

**Toddler Pillow and Pillowcase Colors**



Toddler Pillow

**Youth Pillowcase Colors**



Youth Pillow

**My First Pillow and Pillowcases**

Pillows feature extra-firm high-density memory foam for cushioned comfort and support for the head and neck. Includes a soft velour, machine washable pillowcase for added comfort. Pillowcases also sold separately.

Item #	Description	Product Dimensions	Quantity	Color	List Price
<b>Pillows</b>					
5-5008526-670	Toddler Pillow w/ Case	16 W x 12 D in	Pack of 6	Specify	\$357.95
5-2089876-670	Youth Pillow w/ Case	20 W x 16 D in	Pack of 6	Blue	\$421.95
<b>Pillowcases</b>					
9-5008525-670	Toddler Pillowcase	16 W x 12 D in	Pack of 6	Specify	\$142.95
9-5008524-670	Youth Pillowcase	20 W x 16 D in	Pack of 6	Specify	\$168.95

**Rest Mat Sheets and Blankets**

Keep rest mat surfaces clean and safe from germs with these fitted sheets which are made of a cotton/poly blend with corner pockets to slip over the corners of a 1" or 2" rest mat. Designed to fit Childcraft® rest mats. Don't forget to keep tots comfortable at nap time with a 100% soft cotton double-napped surged blanket. It's extra long, making it perfect for cots or rest mats. Sheets and blankets are machine washable and dryable.



Rest Mat Sheet

Item #	Description	Quantity	Color	List Price
<b>Rest Mat Sheets</b>				
9-1287721-670	Fitted Sheet for 1 or 2 in Mat	Each	White	\$25.95
5-1427744-670	Fitted Sheet for 1 or 2 in Mat	Pack of 12	White	\$262.95
<b>Blankets</b>				
9-1363332-670	Cotton Blanket	Each	White	\$30.95
5-1427750-670	Cotton Blanket	Pack of 12	White	\$332.95



**Childcraft® Universal Rest Mat Storage Unit**

Mobile unit designed to store 1" or 2" thick, 3- or 4-fold rest mats. Each of the ten cubbies is large enough to hold a rest mat, sheet, and blanket. Each shelf measures 22-1/4"W x 24"D x 6-7/8"H. Heavy-duty locking casters. Assembled.

Item #	Description	Product Dimensions	Capacity	List Price
6-2039844-670	Universal Rest Mat Storage	47-3/4 L x 24-3/4 W x 42 H in	10 Mats	\$1,303.95



PRODUCT CERTIFIED FOR LOW CHEMICAL EMISSIONS: UL.COM/IGG UL 2818



**Rest Mat Storage Cart**

The perfect mobile storage unit for rest mats. With blue powder-coated, heavy-duty steel-and-wire frame construction, this cart features four 4-inch rubber casters (2 locking). Holds approximately 40 1-inch rest mats or up to 20 2-inch rest mats.

Item #	Description	Product Dimensions	List Price
5-1599805-670	Storage Cart	52 L x 26 W x 54 H in	\$376.95



PRODUCT CERTIFIED FOR LOW CHEMICAL EMISSIONS: UL COM1000 UL 2819

**CHILD CRAFT**  
A School Specialty® Exclusive



**Compare to the Leading Brand**

**Childcraft® Value Rest Mats**

Durable, comfortable, 4-fold mats are manufactured using radio-frequency vinyl-welding technology which seals all seams protecting the foam padding from liquid and bacteria contamination. Measures 45"L x 19"W inches. Folds to 11"L x 19"W.

Item #	Description	Thickness	Quantity	Color	List Price
9-2026837-670	Rest Mat	¾ in	Each	Blue/Red	\$18.95
5-2026834-670	Rest Mat	¾ in	Pack of 10	Blue/Red	\$180.95

Pack of 10 - Folded



1 inch Mat

**Childcraft® Deluxe Rest Mats**

Durable, comfortable, 4-fold mats are manufactured using triple-ply, cleanable, heavy-duty vinyl with waterproof seals between each section and tear-proof sewn edges. Measures 48"L x 24"W. 1" thick mat folds to 12-½"L x 24"W x 4-¼"H and 2" thick mat folds to 11"L x 24" W x 8-¾" H.

Item #	Description	Thickness	Quantity	Color	List Price
9-2026830-670	Rest Mat	1 in	Each	Red/Blue	\$61.95
9-2026831-670	Rest Mat	2 in	Each	Red/Blue	\$76.95

**Childcraft® Premium Rest Mats**

Durable, cleanable, comfortable mats are manufactured using radio-frequency vinyl-welding technology which seals all seams protecting the foam padding from liquid and bacteria contamination. Includes name tag holder on end of each mat and comes in 3-fold and 4-fold options in three different thicknesses.

Item #	Description	Thickness	Quantity	Color	List Price
<b>3 Fold 45" L x 19" W</b>					
9-2026833-670	3-Fold	¾ in	Each	Red/Blue	\$39.95
5-2026828-670	3-Fold	¾ in	Pack of 15	Red/Blue	\$587.95
<b>3 Fold 48" L x 24" W</b>					
9-2026832-670	3-Fold	1 in	Each	Red/Blue	\$48.95
5-2026829-670	3-Fold	1 in	Pack of 10	Red/Blue	\$475.95
9-2026841-670	3-Fold	2 in	Each	Red/Blue	\$77.95
5-2026842-670	3-Fold	2 in	Pack of 5	Red/Blue	\$377.95
<b>4 Fold 48" L x 24" W</b>					
9-2026838-670	4-Fold	1 in	Each	Red/Blue	\$53.95
5-2026835-670	4-Fold	1 in	Pack of 10	Red/Blue	\$522.95
9-2026839-670	4-Fold	2 in	Each	Red/Blue	\$74.95
5-2026840-670	4-Fold	2 in	Pack of 5	Red/Blue	\$364.95



¾ inch 3-Fold Mat



2 inch 4-Fold Mat



Primary Colors



Earth Tone Colors

**Childcraft® Rainbow Rest Mats**

Durable, cleanable, non-folding 2" thick rest mat comes with name tag holders on end of each mat. Measures 48"L x 24"W.

Item #	Description	Thickness	Quantity	List Price
5-2026827-670	Assorted Primary Colors	2 in	Pack of 5	\$387.95
5-2026836-670	Assorted Earth Tone Colors	2 in	Pack of 5	\$387.95

**CHILDCRAFT®**  
A School Specialty Exclusive



Standard



Toddler



5 Pack Stacked

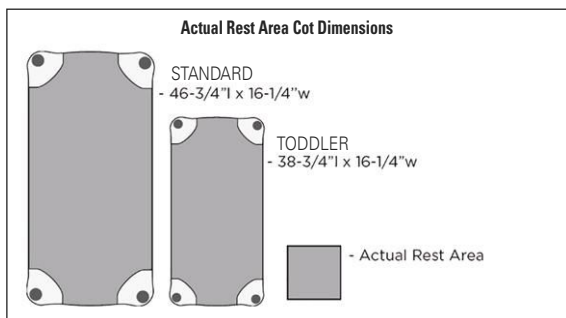

**Childcraft® Premium Stackable Cots**

Tip-resistant, low-profile cots feature moisture resistant beds woven from flame-retardant vinyl coating, super-grip closure at foot end to adjust tautness, and rust-resistant steel frame. Cots are cleanable and nest to save space. Name plates (sold separately) easily clip to cot ends. Accommodates up to 110 lbs.

Item #	Description	Quantity	Color	List Price
<b>Standard - 51-3/4" L x 21-1/2" W x 4-1/2" H in</b>				
5-2026847-670	Standard Ready to Assemble	Pack of 6	Blue	\$432.95
5-2026848-670	Standard Assembled	Each	Blue	\$101.95
5-2026845-670	Standard Assembled	Pack of 5	Blue	\$449.95
<b>Toddler - 43-3/4" L x 21-1/2" W x 4-1/2" H in</b>				
5-2026849-670	Toddler Ready to Assemble	Pack of 6	Blue	\$428.95
5-2026846-670	Toddler Assembled	Each	Blue	\$96.95
5-2026844-670	Toddler Assembled	Pack of 5	Blue	\$423.95



**Cot Accessories**

- Name clips fit all Childcraft® and Children's Factory® Cots
- Clips hold 4 x 3/4 inch name tags and come in packs of 5
- Cot Carrier is made to fit all Childcraft® and Children's Factory® Cots
- Cot Carrier holds up to 24 cots, made for easy maneuverability
- Carrier can adjust to accommodate Standard- and Toddler-size cots

Item #	Description	Product Dimensions	Quantity	List Price
5-2027244-670	Cot Carrier	47-1/4" L x 21" W x 4-3/4" H in	Each	\$202.95
9-2027245-670	Name Clips	3-1/2" L x 2-3/4" W x 1" H in	Pack of 5	\$22.95



Wedgewood Color



**Angeles® SpaceLine® Cots**

SpaceLine® Cots feature a space-saving design allowing nearly double the cots to be nested in each stack! Cots are made with comfortable, strong bleach-cleanable fabric and fully enclosed ends.

Item #	Description	Quantity	Color	List Price
<b>Standard Size - 55 L x 22 W x 5 H in</b>				
5-5003251-670	Standard Single	Each	Specify	\$143.95
5-5003252-670	Standard 4 Pack	Pack of 4	Specify	\$504.95
<b>Toddler Size - 42-1/2 L x 22 W x 5 H in</b>				
5-5003250-670	Toddler 4 Pack	Pack of 4	Specify	\$461.95

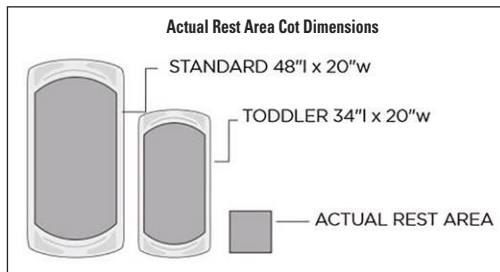

**Colors**

**PLEASE SPECIFY COLOR CHOICE**





Sun



Infinity

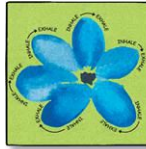

Flower



Sun



Hand



Infinity



### Childcraft® ABC® Furnishings Breathe With Me Washable Carpet Squares

Washable, skid-resistant carpet squares are designed with visual cues to guide young learners to soothe themselves by taking deep breaths in and out.

Item #	Description	Product Dimensions	Color	List Price
5-2040791-670	Set of 4	30 in x 30 in	-	\$181.95
5-5004127-670	Single Breathe Design	30 in x 30 in	Specify	\$57.95



16" Square - Royal Blue



16" Square  
Set of 10 - Royal Blue



24" Square - Sage



24" Square Set of 4 - Primary  
(Navy, Royal Blue, Emerald Green, and Red)



16" Square Set of 10 - Neutral  
(Wheat, Marine Blue, Sage, Navy, and Gray)

### Childcraft® Duralast Carpet Squares

Soft, durable, bleach-resistant carpet squares with natural permanent stain resistance. Perfect for group or circle time.

Item #	Description	Product Dimensions	Color	List Price
5-2040784-670	Set of 10	16 in x 16 in	Royal Blue	\$96.95
5-2040792-670	Set of 10	16 in x 16 in	Neutral	\$96.95
5-5004124-670	Set of 4	24 x 24 in	Specify	\$75.95



24" Square Set of 4 - Neutral  
(Marine Blue, Navy, Sage, and Wheat)



**QUICKSHIP**  
Items ship within 24 hrs, 48 hrs, 1 or 2 weeks as indicated when the factory distribution center receives the order.

Items ship **Freight** or **Parcel** See Shipping & Handling terms for details.



**Childcraft® ABC®  
Furnishings Printed Essential Collection**

- Extra Resistant - carpets have Stainless Stain Protector plus Force 5 anti-microbial agent to resist mildew, odor and mold
- Double-stitched edges won't unravel



Colorful Blocks



USA Capital Map



Learning A-Z



Colorful Confetti

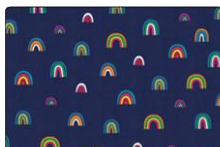

All Over Rainbows



Ombre Stripe

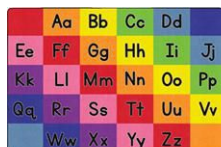

Rainbow Alphabet



Calming Leavee - Green



Calming Leaves - Blue

Item #	Description	Product Dimensions	Color	List Price
<b>Colorful Blocks</b>				
5-2009625-670	Rectangle - Seats 20	6 ft x 9 ft	Primary	\$304.95
5-2009626-670	Rectangle - Seats 24	8 ft x 12 ft	Primary	\$513.95
<b>Learning A-Z</b>				
5-2009613-670	Rectangle	6 ft x 9 ft	Primary	\$304.95
5-2009616-670	Rectangle	8 ft x 12 ft	Primary	\$513.95
<b>USA Capital Map</b>				
5-2010946-670	Rectangle	6 ft x 9 ft	Primary	\$304.95
5-2010947-670	Rectangle	8 ft x 12 ft	Primary	\$513.95
<b>Colorful Confetti</b>				
5-2091364-670	Rectangle	6 ft x 9 ft	Primary	\$304.95
5-2091376-670	Rectangle	8 ft x 12 ft	Primary	\$513.95
<b>All Over Rainbows</b>				
5-2091371-670	Rectangle	6 ft x 9 ft	Primary	\$304.95
5-2091377-670	Rectangle	8 ft x 12 ft	Primary	\$513.95
<b>Ombre Stripe</b>				
5-2091378-670	Rectangle	6 ft x 9 ft	Primary	\$304.95
5-2091375-670	Rectangle	8 ft x 12 ft	Primary	\$513.95
<b>Rainbow Alphabet</b>				
5-2105281-670	Rectangle	<b>NEW</b> 6 ft x 9 ft	Primary	\$304.95
5-2105277-670	Rectangle	<b>NEW</b> 8 ft x 12 ft	Primary	\$513.95
<b>Calming Leaves</b>				
5-5009859-670	Rectangle	<b>NEW</b> 6 ft x 9 ft	Specify	\$304.95
5-5009858-670	Rectangle	<b>NEW</b> 8 ft x 12 ft	Specify	\$513.95



Zoom Around



Up in Space



Alphabet Pals



Hopscotch



Pattern Squares



Chalk Alphabet Seating

**Childcraft® ABC®  
Furnishings Washable Collection**

- Easy Care - machine washable with skid-resistant backing
- Durable Design - kids rug built with high density nylon fiber and double-stitched edges for strength

Item #	Description	Product Dimensions	Color	List Price	Item #	Description	Product Dimensions	Color	List Price
<b>Zoom Around Town</b>					<b>Hopscotch</b>				
5-2049430-670	Rectangle	4 ft x 6 ft	Primary	\$137.95	5-2009396-670	Rectangle	2 ft 6 in x 7 ft	Primary	\$45.95
5-2049431-670	Rectangle	5 ft x 8 ft	Primary	\$227.95	<b>Up in Space</b>				
<b>Pattern Squares</b>					5-2091363-670	Rectangle	4 ft x 6 ft	Primary	\$137.95
5-2010992-670	Rectangle	4 ft x 6 ft	Primary	\$137.95	5-2091369-670	Rectangle	5 ft x 8 ft	Primary	\$227.95
5-2010993-670	Rectangle	5 ft x 8 ft	Primary	\$227.95	<b>Alphabet Pals</b>				
<b>Chalk Alphabet Seating</b>					5-2091365-670	Rectangle	4 ft x 6 ft	Primary	\$137.95
5-2009610-670	Rectangle	4 ft x 6 ft	Primary	\$137.95	5-2091374-670	Rectangle	5 ft x 8 ft	Primary	\$227.95
5-2009609-670	Rectangle	5 ft x 8 ft	Primary	\$227.95					





StA<sup>+</sup>inless

**CHILDCRAFT®**  
A School Specialty® Exclusive

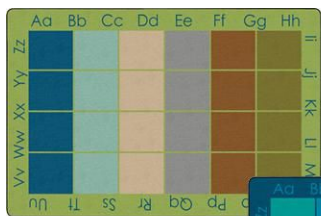

Neutral - Seats 24

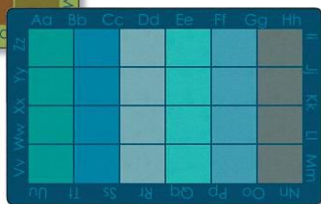

Cool Tone - Seats 24



Primary - Seats 20

### Childcraft® Alphabet Squares Carpet

Colorful rows make it easy to seat students for story time and other group activities.

Item #	Description	Product Dimensions	Color	List Price
5-5000243-670	Rectangle - Seats 20	6 ft x 9 ft	Specify	\$415.95
5-5000242-670	Rectangle - Seats 24	8 ft x 12 ft	Specify	\$608.95
6-5000245-670	Rectangle - Seats 30	10 ft 6 in x 13 ft 2 in	Specify	\$821.95

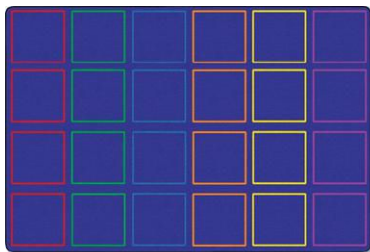

Rectangle - Seats 24



Rectangle - Seats 30

### Childcraft® Rainbow Squares Carpet

Large rainbow-colored squares make it easy to seat students for story time and other group activities.

Item #	Description	Product Dimensions	Color	List Price
5-2024814-670	Rectangle - Seats 20	6 ft x 9 ft	Blue	\$415.95
5-2024835-670	Rectangle - Seats 24	8 ft x 12 ft	Blue	\$608.95
6-2024829-670	Rectangle - Seats 30	10 ft 6 in x 13 ft 2 in	Blue	\$821.95

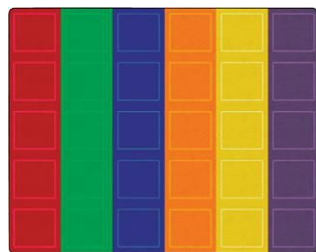

Primary - Seats 30

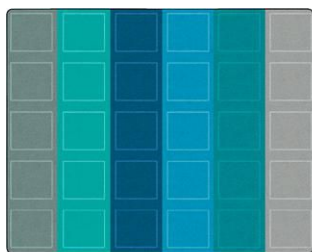

Cool Tone - Seats 30

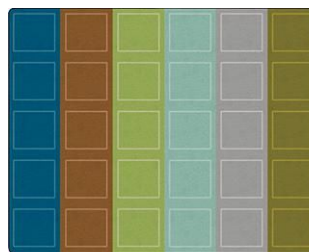

Neutral - Seats 30



Muted - Seats 30

### Childcraft® Everyone's A Star Carpet

Horizontal rows feature colorful stars within square sections for story time seating or other group activities.

Item #	Description	Product Dimensions	Color	List Price
5-2003743-670	Rectangle - Seats 20	6 ft x 9 ft	Primary	\$415.95
5-2003748-670	Rectangle - Seats 24	8 ft x 12 ft	Primary	\$608.95
6-2003749-670	Rectangle - Seats 30	10 ft 6 in x 13 ft 2 in	Primary	\$821.95

### Childcraft® Rainbow Squares Carpet

Large colorful squares make it easy to seat students for story time and other group activities.

Item #	Description	Product Dimensions	Color	List Price
5-5003041-670	Rectangle - Seats 20	6 ft x 9 ft	Specify	\$415.95
5-5003035-670	Rectangle - Seats 24	8 ft x 12 ft	Specify	\$608.95
6-5003039-670	Rectangle - Seats 30	10 ft 6 in x 13 ft 2 in	Specify	\$821.95



**QUICKSHIP** Items ship within 24 hrs, 48 hrs, 1 or 2 weeks as indicated when the factory distribution center receives the order.

Items ship **Freight** or **Parcel** See Shipping & Handling terms for details.





Black - Seats 30

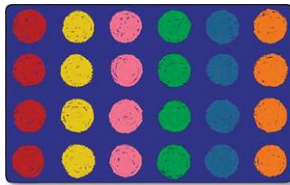

Blue - Seats 24



Black - Seats 30

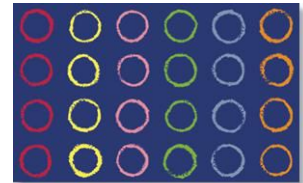

Blue - Seats 24

**Childcraft® Chalk Spots Carpet**

Brightly-colored chalk spots make classroom seating easy.

Item #	Description	Product Dimensions	Color	List Price
5-5000251-670	Rectangle - Seats 20	6 ft x 9 ft	Specify	\$415.95
5-5000252-670	Rectangle - Seats 24	8 ft x 12 ft	Specify	\$608.95
6-5000250-670	Rectangle - Seats 30	10 ft 6 in x 13 ft 2 in	Specify	\$821.95

**Childcraft® Chalk Seating Rings Carpet**

Brightly-colored chalk rings make classroom seating easy.

Item #	Description	Product Dimensions	Color	List Price
5-5003038-670	Rectangle - Seats 20	6 ft x 9 ft	Specify	\$415.95
5-5003034-670	Rectangle - Seats 24	8 ft x 12 ft	Specify	\$608.95
6-5003036-670	Rectangle - Seats 30	10 ft 6 in x 13 ft 2 in	Specify	\$821.95

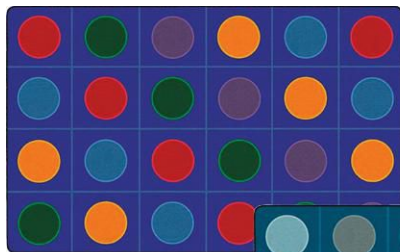

Primary - Seats 24

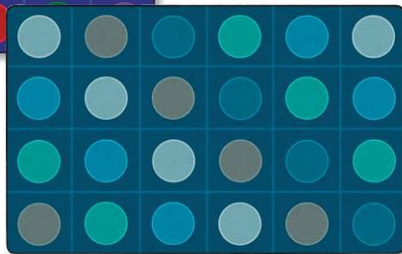

Cool Tone - Seats 24



Primary

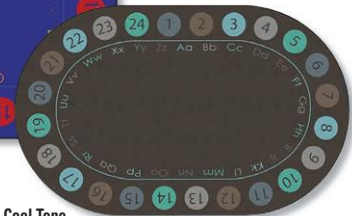

Cool Tone

**Childcraft® Colorful Circles ABC123 Carpet**

Numbered seating spots for group activities and circle time.

Inside border of uppercase and lowercase letters helps encourage letter recognition.

Item #	Description	Product Dimensions	Color	List Price
5-5000263-670	Rectangle	6 ft x 9 ft	Specify	\$415.95
5-5000265-670	Rectangle	8 ft x 12 ft	Specify	\$608.95
6-5000264-670	Rectangle	10 ft 6 in x 13 ft 2 in	Specify	\$821.95
5-5000262-670	Oval	6 ft x 9 ft	Specify	\$415.95
5-5000266-670	Oval	8 ft x 12 ft	Specify	\$608.95
6-5000267-670	Oval	10 ft 6 in x 13 ft 2 in	Specify	\$821.95

**Childcraft® Colorful Circles Carpet**

Colorful round spots provide a seat for each child in the classroom.

Item #	Description	Product Dimensions	Color	List Price
5-5000268-670	Rectangle - Seats 20	6 ft x 9 ft	Specify	\$415.95
5-5000269-670	Rectangle - Seats 24	8 ft x 12 ft	Specify	\$608.95
6-5000272-670	Rectangle - Seats 30	10 ft 6 in x 13 ft 2 in	Specify	\$821.95



Primary

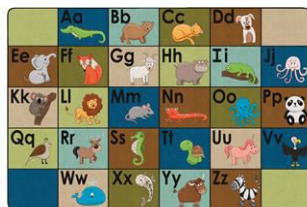

Earth Tone

**Childcraft® Alphabet Friends Carpet**

From A and alligators to Z and zebras, this carpet makes learning fun!

Item #	Description	Product Dimensions	Color	List Price
5-5004715-670	Rectangle	4 ft x 6 ft	Specify	\$210.95
5-5004716-670	Rectangle	6 ft x 9 ft	Specify	\$415.95
5-5004713-670	Rectangle	8 ft x 12 ft	Specify	\$608.95
6-5004714-670	Rectangle	10 ft 6 in x 13 ft 2 in	Specify	\$821.95



**Childcraft® ABC Blocks Carpet**

Practice writing the ABC's with this fun learning carpet!

Item #	Description	Product Dimensions	Color	List Price
5-2105280-670	Rectangle	6 ft x 9 ft	Black	\$415.95
5-2105284-670	Rectangle	8 ft x 12 ft	Black	\$608.95
6-2105283-670	Rectangle	10 ft 6 in x 13 ft 2 in	Black	\$821.95



St<sup>A+</sup>inless

**CHILD CRAFT**  
A School Specialty® Exclusive

**NEW**

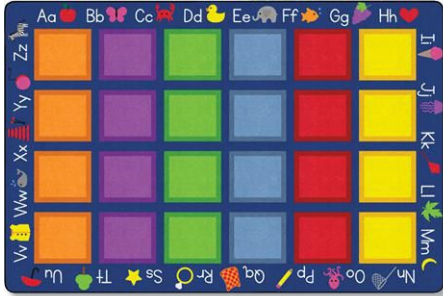

**Childcraft® Colorful Squares Carpet**

Create an inviting, colorful space where young learners can gather for seating, circle time, or classroom activities.

Item #	Description	Product Dimensions	Color	List Price
5-2105269-670	Rectangle	6 ft x 9 ft	Primary	\$415.95
5-2105285-670	Rectangle	8 ft x 12 ft	Primary	\$608.95
6-2105273-670	Rectangle	10 ft 6 in x 13 ft 2 in	Primary	\$821.95

**NEW**



**Childcraft® Alphabet Pictures Carpet**

Alphabet Pictures carpet is a fun way to learn letter and sound recognition.

Item #	Description	Product Dimensions	Color	List Price
5-2105265-670	Rectangle	6 ft x 9 ft	Primary	\$415.95
5-2105275-670	Rectangle	8 ft x 12 ft	Primary	\$608.95
6-2105276-670	Rectangle	10 ft 6 in x 13 ft 2 in	Primary	\$821.95

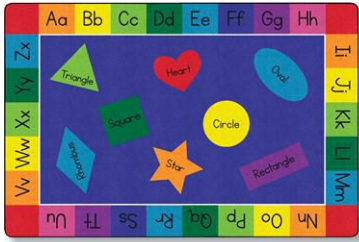

**Childcraft® Rainbow of Shapes Carpet**

Students will learn the alphabet and eight basic shapes with this vibrant, colorful carpet.

Item #	Description	Product Dimensions	Color	List Price
5-2105264-670	Rectangle	6 ft x 9 ft	Primary	\$415.95
5-2105279-670	Rectangle	8 ft x 12 ft	Primary	\$608.95
6-2105268-670	Rectangle	10 ft 6 in x 13 ft 2 in	Primary	\$821.95
5-2105266-670	Oval	6 ft x 9 ft	Primary	\$415.95
5-2105270-670	Oval	8 ft x 12 ft	Primary	\$608.95
6-2105267-670	Oval	10 ft 6 in x 13 ft 2 in	Primary	\$821.95
5-2105274-670	Round	6 ft dia	Primary	\$259.95

**NEW**

**NEW**

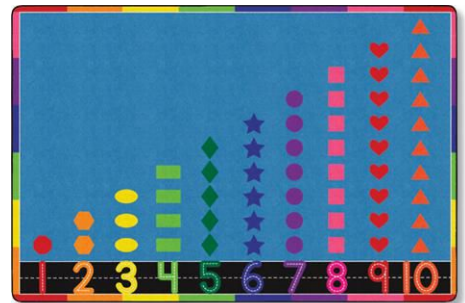

**Childcraft® Count with Me Carpet**

Count with Me aids in numeral recognition and number order while learning shapes and colors too!

Item #	Description	Product Dimensions	Color	List Price
5-2105286-670	Rectangle	6 ft x 9 ft	Primary	\$415.95
5-2105271-670	Rectangle	8 ft x 12 ft	Primary	\$608.95
6-2105287-670	Rectangle	10 ft 6 in x 13 ft 2 in	Primary	\$821.95



**Childcraft® Bilingual Carpet**

Read, recite, and "count" on this early education carpet to teach numbers, colors, and literacy in English and Spanish.

Item #	Description	Product Dimensions	List Price
5-2024807-670	Rectangle	6 ft x 9 ft	\$415.95
5-2024831-670	Rectangle	8 ft x 12 ft	\$608.95
6-2024820-670	Rectangle	10 ft 6 in x 13 ft 2 in	\$821.95
5-2024810-670	Oval	8 ft x 12 ft	\$608.95
6-2024816-670	Oval	10 ft 6 in x 13 ft 2 in	\$821.95



**Childcraft® Geography World Map Carpet**

Explore and learn the 7 continents and oceans around the world.

Item #	Description	Product Dimensions	List Price
5-2003758-670	Rectangle	6 ft x 9 ft	\$415.95
5-2003759-670	Rectangle	8 ft x 12 ft	\$608.95
6-2003755-670	Rectangle	10 ft 6 in x 13 ft 2 in	\$821.95



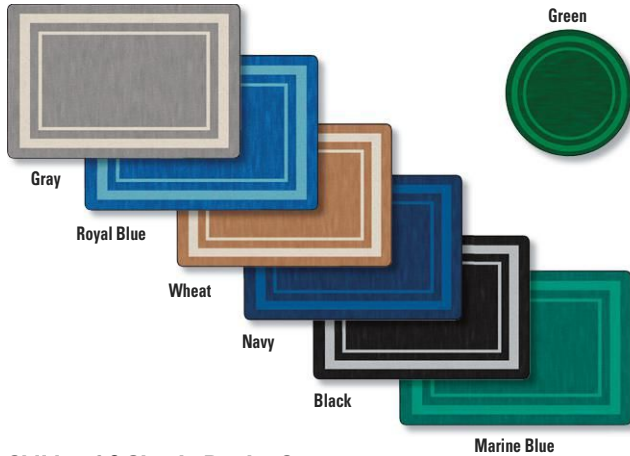

**Childcraft® Simple Border Carpet**

Create a warm, comfortable space in the classroom with a simple carpet design.

Item #	Description	Product Dimensions	Color	List Price
5-5004091-670	Rectangle	6 ft x 9 ft	Specify	\$415.95
5-5004090-670	Rectangle	8 ft x 12 ft	Specify	\$608.95
6-5004869-670	Rectangle	10 ft 6 in x 13 ft 2 in	Specify	\$821.95
5-5004093-670	Round	6 ft dia	Specify	\$259.95
5-5004092-670	Round	8 ft dia	Specify	\$415.95
6-5004868-670	Round	13 ft 2 in dia	Specify	\$1,230.95



Cool Tone

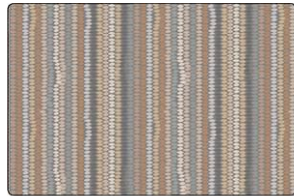

Neutral

**Childcraft® Cobblestone Stripe**

Bring the feeling of home to the classroom with this chunky stripe. The cool tone and neutral colors will enhance any classroom décor.

Item #	Description	Product Dimensions	Color	List Price
5-5009028-670	Rectangle	4 ft x 6 ft	Specify	\$210.95
5-5009026-670	Rectangle	6 ft x 9 ft	Specify	\$415.95
5-5009015-670	Rectangle	8 ft x 12 ft	Specify	\$608.95
6-5009029-670	Rectangle	10 ft 6 in x 13 ft 2 in	Specify	\$821.95



Navy

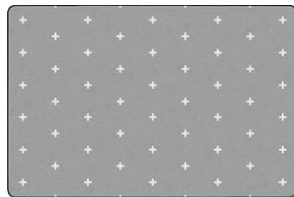

Gray

**Childcraft® Positive Signs**

Create a cozy space in the classroom or childcare development center with this simple, modern design.

Item #	Description	Product Dimensions	Color	List Price
5-5009021-670	Rectangle	4 ft x 6 ft	Specify	\$210.95
5-5009030-670	Rectangle	6 ft x 9 ft	Specify	\$415.95
5-5009024-670	Rectangle	8 ft x 12 ft	Specify	\$608.95
6-5009008-670	Rectangle	10 ft 6 in x 13 ft 2 in	Specify	\$821.95

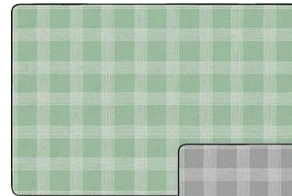

Green



Blue

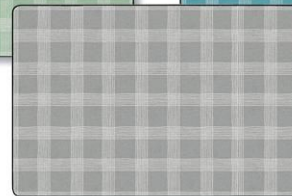

Gray

**Childcraft® Peaceful Plaid**

Make your space feel like home with our Peaceful Plaid carpet. Great for classrooms, library, or childcare development center.

Item #	Description	Product Dimensions	Color	List Price
5-5009013-670	Rectangle	4 ft x 6 ft	Specify	\$210.95
5-5009019-670	Rectangle	6 ft x 9 ft	Specify	\$415.95
5-5009038-670	Rectangle	8 ft x 12 ft	Specify	\$608.95

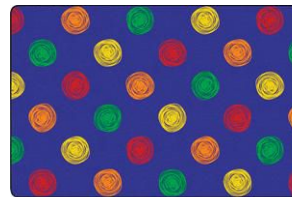

Primary



Neutral

**Childcraft® Doodle Dots**

Doodle Dots carpet adds comfort and fun to any early learning space. Great for circletime, story time or classroom activities.

Item #	Description	Product Dimensions	Color	List Price
5-5009031-670	Rectangle	4 ft x 6 ft	Specify	\$210.95
5-5009010-670	Rectangle	6 ft x 9 ft	Specify	\$415.95
5-5009037-670	Rectangle	8 ft x 12 ft	Specify	\$608.95
6-5009034-670	Rectangle	10 ft 6 in x 13 ft 2 in	Specify	\$821.95





StA<sup>+</sup>inless

**CHILD CRAFT**  
A School Specialty® Exclusive



**BLEACH RESISTANT**

**Childcraft® Duralast Collection Carpet and Carpet Squares**

Childcraft® Duralast Collection features exceptional softness, with permanent stain and bleach resistance. Made of 25% recycled content, this collection has improved strength and better abrasion resistance to withstand the most rugged classroom.

**16" Set of 10 Neutral carpet squares includes** two of each color of Wheat, Marine Blue, Gray, Sage Green, and Navy Blue.

**24" Set of 4 Neutral carpet squares includes** one of each color Navy Blue, Sage Green, Marine Blue, and Wheat.

**24" Set of 4 Primary carpet squares includes** one of each color Navy Blue, Classic Red, Royal Blue, and Emerald Green.

Meets or exceeds Class I fire rating as specified in NFPA Life Safety Code 101.

Item #	Description	Product Dimensions	Color	List Price
<b>Carpets</b>				
5-5001023-670	Rectangle	4 ft x 6 ft	Specify	\$144.95
5-5001024-670	Rectangle	6 ft x 9 ft	Specify	\$210.95
5-5001022-670	Rectangle	8 ft x 12 ft	Specify	\$340.95
6-5004098-670	Rectangle	12 ft x 15 ft	Specify	\$682.95
6-5004097-670	Square	12 ft x 12 ft	Specify	\$553.95
5-5001025-670	Oval	8 ft x 12 ft	Specify	\$340.95
5-5009014-670	Round	6 ft dia	Specify	\$203.95
6-5009009-670	Round	12 ft dia	Specify	\$713.95
<b>Carpet Squares</b>				
5-2040792-670	Set of 10	16 in x 16 in	Neutral	\$96.95
5-2040784-670	Set of 10	16 in x 16 in	Royal Blue	\$96.95
5-5004124-670	Set of 4	24 x 24 in	Specify	\$75.95



**Childcraft® Select Solid Collection Carpet**

The Childcraft® Select carpet is a soft, thick 32 oz weight. Constructed with durable, stain-resistant nylon fiber and double-stitched serged edges. Class 1 flammability rating.

Item #	Description	Product Dimensions	Color	List Price
5-5001027-670	Rectangle	4 ft x 6 ft	Specify	\$143.95
5-5001028-670	Rectangle	6 ft x 9 ft	Specify	\$299.95
5-5001030-670	Rectangle	8 ft x 12 ft	Specify	\$451.95
5-5001029-670	Oval	8 ft x 12 ft	Specify	\$451.95
5-5009012-670	Round	6 ft dia	Specify	\$226.95
6-5009011-670	Round	12 ft dia	Specify	\$809.95

**Childcraft® ABC® Furnishings Essential Solid Carpet**

Perfect classroom carpet for kids to gather and play. Easy to clean, this carpet is resilient and stain-resistant, along with double-stitched serged edges. Great for the budget minded. Meets or exceeds Class I fire rating as specified in NFPA Life Safety Code 101. Made in USA. Specify color choice.

Item #	Description	Product Dimensions	Color	List Price
5-5001020-670	Rectangle	4 ft x 6 ft	Specify	\$118.95
5-5001019-670	Rectangle	6 ft x 9 ft	Specify	\$215.95
5-5001021-670	Rectangle	8 ft x 12 ft	Specify	\$346.95
5-5001026-670	Oval	8 ft x 12 ft	Specify	\$346.95
5-5009035-670	Round	6 ft dia	Specify	\$186.95
6-5009032-670	Round	12 ft dia	Specify	\$668.95



All My Feelings

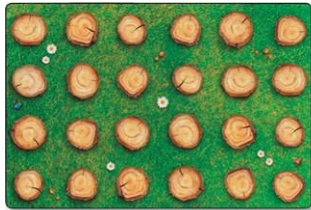

Seating Stumps

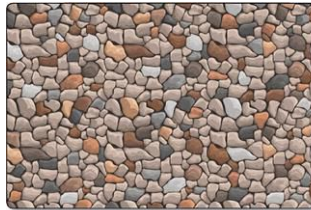

Rock Picture



Dandelion Seating



Hardwood Floor - Autumn Oak



Hardwood Floor - Natural Maple



Hardwood Floor - Stone Oak

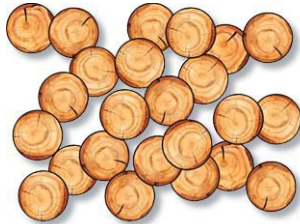

Stump Rounds



Food Squares



Alphabet Squares

**Childcraft® Photo Fun Carpets**

- 25% thicker and heavier than the leading educational carpets
- Class 1 Fire rated and exceed California's indoor air quality standards for low emitting products used in schools
- Unlike a topical stain protection, Stainless is absorbed into each carpet fiber to permanently prevent against stains
- Created with materials known for their strength, excellent stain and fade resistance, and appearance retention. 76 DPI Enhanced Digital Dye Injection

Item #	Description	Product Dimensions	Color	List Price
<b>Seating Stumps</b>				
5-2024836-670	Rectangle	6 ft x 9 ft	-	\$481.95
5-2024819-670	Rectangle	8 ft x 12 ft	-	\$666.95
6-2024833-670	Rectangle	10 ft 6 in x 13 ft 2 in	-	\$875.95
<b>Hardwood Floor</b>				
5-5003293-670	Rectangle	6 ft x 9 ft	Specify	\$481.95
5-5003294-670	Rectangle	8 ft x 12 ft	Specify	\$666.95
6-5003295-670	Rectangle	10 ft 2 in x 13 ft 2 in	Specify	\$875.95
<b>Rock Picture</b>				
5-2024817-670	Rectangle	4 ft x 6 ft	-	\$242.95
5-2024828-670	Rectangle	6 ft x 9 ft	-	\$481.95
5-2024811-670	Rectangle	8 ft x 12 ft	-	\$666.95
<b>Dandelions Seating</b>				
5-2003751-670	Rectangle - Seats 20	6 ft x 9 ft	-	\$481.95
5-2003744-670	Rectangle - Seats 24	8 ft x 12 ft	-	\$666.95
6-2003742-670	Rectangle - Seats 30	10 ft 6 in x 13 ft 2 in	-	\$875.95
<b>All My Feelings</b>				
5-2009569-670	Rectangle - Seats 20	6 ft x 9 ft	Blue	\$481.95
5-2009570-670	Rectangle - Seats 24	8 ft x 12 ft	Blue	\$666.95
6-2009571-670	Rectangle - Seats 30	10 ft 6 in x 13 ft 2 in	Blue	\$875.95
<b>Seating Squares &amp; Rounds</b>				
5-2027050-670	Food Squares - Set of 10	16 in x 16 in	-	\$125.95
5-2024806-670	Stump Rounds - Set of 24	16 in x 16 in	-	\$281.95
5-2105272-670	Alphabet Squares - Set of 26 <b>NEW</b>	16 in x 16 in	-	\$281.95



Carpets for  
**KIDS** etc...  
When Quality Counts!



Carpets for Kids®, established in 1992, is the industry leader in providing high-quality, educational carpets for child care centers, schools and homes across the country. Amazing colors and innovative designs make Carpets For Kids® the best choice for quality children's carpets!

- Lifetime Abrasive Wear Warranty
- No Fault Edge Warranty
- 100% American Made
- Advanced Stain Blocker Technology
- Quick-Ship ALL CFK products in 24 HOURS or LESS!
- Clean with hot water extraction, no harsh chemicals needed!



**Carpets for Kids® KIDSoft™ Toddler Alphabet Blocks Carpet**

These children's educational play carpets provide a perfect, cozy space for playing, toddling, and learning. Individual alphabet carpet squares add interactive matching. Plush yarns create a warm and cozy area for little ones to snuggle up and play.

Item #	Description	Product Dimensions	Color	List Price
5-1396526-670	Rectangle	4 ft x 6 ft	Primary	\$245.95
5-1396527-670	Rectangle	6 ft x 9 ft	Primary	\$460.95
5-1428114-670	Rectangle	8 ft x 12 ft	Primary	\$678.95
5-1467811-670	Squares - Set of 26	14 in x 14 in	Primary	\$305.95
5-1396524-670	Rectangle	4 ft x 6 ft	Neutral	\$245.95
5-1396525-670	Rectangle	6 ft x 9 ft	Neutral	\$460.95
5-1431580-670	Rectangle	8 ft x 12 ft	Neutral	\$678.95
5-1469363-670	Squares - Set of 26	14 in x 14 in	Neutral	\$305.95

**GO Online for more shapes and sizes**



**Carpets for Kids® KIDSoft™ Tranquil Trees Carpet**

Happy little trees will be a fun and welcoming addition to any room or learning space. The soft, gentle-to-the-touch fibers create a warm and cozy area for little ones to snuggle up and play.

Item #	Description	Product Dimensions	Color	List Price
5-1593501-670	Rectangle	4 ft x 6 ft	Blue	\$245.95
5-1593503-670	Rectangle	4 ft x 6 ft	Green	\$245.95
5-1593505-670	Rectangle	4 ft x 6 ft	Tan	\$245.95
5-1593502-670	Rectangle	6 ft x 9 ft	Blue	\$460.95
5-1593504-670	Rectangle	6 ft x 9 ft	Green	\$460.95
5-1593506-670	Rectangle	6 ft x 9 ft	Tan	\$460.95
5-2019705-670	Rectangle	8 ft x 12 ft	Blue	\$678.95
5-2019729-670	Rectangle	8 ft x 12 ft	Green	\$678.95
5-2019665-670	Rectangle	8 ft x 12 ft	Tan	\$678.95
5-2000536-670	Round	6 ft dia	Blue	\$314.95
5-2000537-670	Round	6 ft dia	Green	\$314.95
5-2000538-670	Round	6 ft dia	Tan	\$314.95



**Carpets for Kids® Reading Letters Library Carpet**

Check out these fun and zany letters as they encourage kids to read and learn. Large seating spaces will provided each child with their own spot to help with organization in a classroom or library.

Item #	Description	Product Dimensions	List Price
5-1467837-670	Rectangle	7 ft 6 in x 12 ft	\$595.95
6-1465943-670	Rectangle	8 ft 4 in x 13 ft 4 in	\$722.95



**Carpets for Kids® Sequential Seating Literacy Carpet**

The sequential alphabet features upper and lower case letters with a matching icon in each square. Numbers and shapes make this a great multipurpose carpet that can be used for a variety of lessons and a great tool to encourage learning.

Item #	Description	Product Dimensions	List Price
5-1544405-670	Rectangle	4 ft x 6 ft	\$245.95
5-1544404-670	Rectangle	6 ft x 9 ft	\$460.95
5-1544406-670	Rectangle	8 ft x 12 ft	\$678.95
6-1544407-670	Rectangle	8 ft 4 in x 13 ft 4 in	\$722.95
5-2102582-670	Oval <b>NEW</b>	6 ft 9 in x 9 ft 5 in	\$460.95
6-2102586-670	Oval <b>NEW</b>	7 ft 6 in x 12 ft	\$595.95
5-1544408-670	Literacy Seating, Set of 26	12 in x 12 in	\$233.95



**Carpets for Kids® Rainbow Seating Carpet**

Simple and sweet, this colorful and beautiful arena-style seating carpet will brighten up any room. The large seating spaces provide a great tool to organize your classroom for circle time, story time, or anytime!

Item #	Description	Product Dimensions	List Price
5-1544402-670	Rectangle	7 ft 6 in x 12 ft	\$595.95
6-1544403-670	Rectangle	8 ft 4 in x 13 ft 4 in	\$722.95



Carpets for  
**KIDS**®  
etc...  
When Quality Counts!



Set of 35  
Carpet Squares



**Carpets for Kids® Calendar Carpet**

These colorful multifunctional carpets are ideal for imaginative and cognitive play. Use for activities ranging from number and letter recognition to teaching days of the week and months of the year. Add the Calendar Numbers Kit, 12" x 12" squares numbered 1-31 plus 4 special days, so that everyone can have a day to celebrate!

Item #	Description	Product Dimensions	List Price
5-076246-670	Rectangle	7 ft 6 in x 12 ft	\$595.95
6-066923-670	Rectangle	8 ft 4 in x 13 ft 4 in	\$722.95
5-066924-670	Squares - Set of 35	12 in x 12 in	\$244.95



**Carpets for Kids® A to Z Animal Carpet**

Animals, from alligator to zebra, provide the perfect place for children to sit and learn their alphabet. Add the A to Z Animal Squares for matching fun.

Item #	Description	Product Dimensions	List Price
5-090639-670	Rectangle	7 ft 6 in x 12 ft	\$595.95
6-090640-670	Rectangle	8 ft 4 in x 13 ft 4 in	\$722.95
5-128591-670	Oval	6 ft 9 in x 9 ft 5 in	\$460.95
5-128592-670	Oval	8 ft 3 in x 11 ft 8 in	\$702.95
5-679214-670	Squares - Set of 26	12 in x 12 in	\$233.95



**Carpets for Kids® Reading by the Book Carpet**

Designed specifically for library and classroom reading or circle time areas. Each letter of the alphabet is displayed on its own book with a fun image to help children connect the sound of each letter.

Item #	Description	Product Dimensions	List Price
5-082426-670	Rectangle	5 ft 10 in x 8 ft 4 in	\$432.95
5-082427-670	Rectangle	7 ft 6 in x 12 ft	\$595.95
6-082428-670	Rectangle	8 ft 4 in x 13 ft 4 in	\$722.95
5-086904-670	Semi-Circle	6 ft 8 in x 13 ft 4 in	\$677.95
5-334727-670	Oval	6 ft 9 in x 9 ft 5 in	\$460.95
5-334729-670	Oval	8 ft 3 in x 11 ft 8 in	\$702.95
5-1467812-670	Squares - Set of 26	12 in x 12 in	\$233.95



**Carpets for Kids® Blocks of Fun Carpet**

Incorporates basic shapes, numbers, and the alphabet with related phonics images, making learning a truly fun experience. Add the Alphabet Phonics Squares, Alphabet Carpet Squares, or the Shapes & Numbers Carpet Squares to expand your learning options!

Item #	Description	Product Dimensions	List Price
<b>Carpets</b>			
5-076278-670	Rectangle	4 ft 5 in x 5 ft 10 in	\$255.95
5-521198-670	Rectangle	5 ft 10 in x 8 ft 4 in	\$432.95
5-521197-670	Rectangle	8 ft 4 in x 11 ft 8 in	\$702.95
5-128593-670	Oval	6 ft 9 in x 9 ft 5 in	\$460.95
5-128594-670	Oval	8 ft 3 in x 11 ft 8 in	\$702.95
<b>Carpet Squares</b>			
5-1324812-670	Alphabet Phonics Set of 26	12 in x 12 in	\$233.95
5-1303755-670	Alphabet Squares Set of 26	12 in x 12 in	\$233.95
5-520720-670	Shapes and Numbers Set of 20	12 in x 12 in	\$177.95



**Carpets for Kids® Bilingual Paint by Numero Carpet**

Kids learn colors in English and Spanish while practicing alpha-numeric skills.

Item #	Description	Product Dimensions	List Price
5-086733-670	Oval	6 ft 9 in x 9 ft 5 in	\$460.95
5-086734-670	Oval	8 ft 3 in x 11 ft 8 in	\$702.95

Carpets for  
**KIDS**® etc...  
When Quality Counts!



**Carpets for Kids® Sunny Day Learn & Play Carpet**

Every day is sunny with these colorful carpets. Help teach letter and color recognition while numbers "walk" in the clouds to encourage number skills.

Item #	Description	Product Dimensions	List Price
5-078454-670	Rectangle	4 ft 5 in x 5 ft 10 in	\$255.95
5-078452-670	Rectangle	5 ft 10 in x 8 ft 4 in	\$432.95
5-078453-670	Rectangle	8 ft 4 in x 11 ft 8 in	\$702.95
5-078451-670	Oval	4 ft 5 in x 5 ft 10 in	\$255.95
5-078455-670	Oval	6 ft 9 in x 9 ft 5 in	\$460.95
5-078456-670	Oval	8 ft 3 in x 11 ft 8 in	\$702.95

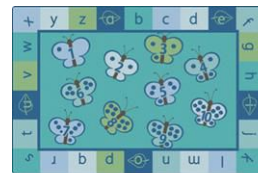

**Carpets for Kids® KIDSoft™ 123 ABC Butterfly Fun Carpet**

Time will flutter by as children learn their numbers 1-10 and the alphabet on these bright and colorful carpets. Push yarns create a warm and cozy area for little ones to snuggle up and play.

Item #	Description	Product Dimensions	Color	List Price
5-679215-670	Rectangle	3 ft 10 in x 5 ft 5 in	Primary	\$224.95
5-1540074-670	Rectangle	6 ft x 9 ft	Primary	\$460.95
5-1540075-670	Rectangle	8 ft x 12 ft	Primary	\$678.95
5-2102602-670	Rectangle <b>NEW</b>	4 ft x 6 ft	Contemporary	\$245.95
5-2102580-670	Rectangle <b>NEW</b>	6 ft x 9 ft	Contemporary	\$460.95
5-2102603-670	Rectangle <b>NEW</b>	7 ft 6 in x 12 ft	Contemporary	\$636.95
5-679218-670	Oval	3 ft 10 in x 5 ft 5 in	Primary	\$224.95
5-679219-670	Oval	6 ft 9 in x 9 ft 5 in	Primary	\$460.95
5-1540073-670	Oval	8 ft x 12 ft	Primary	\$678.95



**Carpets for Kids® Fishing for Literacy Carpet**

Kids get hooked on literacy and counting with these fun fishy friends. The alphabet bubbles on the outside of the carpets provide a perfect circle time setting.

Item #	Description	Product Dimensions	List Price
5-091540-670	Rectangle	3 ft 10 in x 5 ft 5 in	\$224.95
5-1512759-670	Rectangle	6 ft x 9 ft	\$460.95
5-1512760-670	Rectangle	8 ft x 12 ft	\$678.95
5-091543-670	Oval	3 ft 10 in x 5 ft 5 in	\$224.95
5-1512761-670	Oval	6 ft x 9 ft	\$460.95
5-091546-670	Oval	6 ft 9 in x 9 ft 5 in	\$460.95
5-1512763-670	Oval	8 ft x 12 ft	\$678.95



**Carpets for Kids® Read to Dream Border Carpet**

Learn, Read, Dream, Grow! These carpets provide a great place for gathering and reading in any childhood setting.

Item #	Description	Product Dimensions	List Price
5-1467841-670	Rectangle	4 ft x 6 ft	\$245.95
5-1467842-670	Rectangle	6 ft x 9 ft	\$460.95
5-1463484-670	Rectangle	8 ft x 12 ft	\$678.95



**Carpets for Kids® World Explorer Carpet**

Explore the oceans and continents of the world on these brightly-colored carpets designed to teach basic geography.

Item #	Description	Product Dimensions	List Price
5-520723-670	Rectangle	4 ft 5 in x 5 ft 10 in	\$255.95
5-509372-670	Rectangle	5 ft 10 in x 8 ft 4 in	\$432.95
5-509375-670	Rectangle	8 ft 4 in x 11 ft 8 in	\$702.95

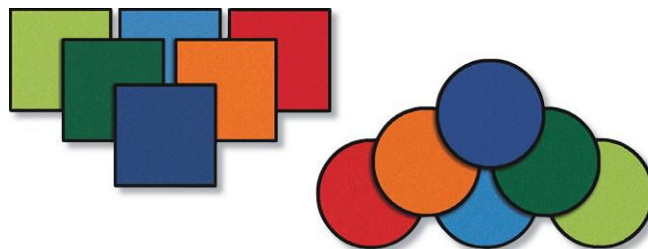

**Carpets for Kids® Kits on the Go Carpet Squares and Rounds**

Set of 24 includes 4 of each color and carrying case; Set of 12 includes 2 of each color. 5-Year Limited Abrasive Wear Warranty.

Item #	Description	Product Dimensions	List Price
5-1544416-670	Squares - Set of 12	16 in x 16 in	\$152.95
5-1544414-670	Squares - Set of 24	16 in x 16 in	\$245.95
5-1544415-670	Rounds - Set of 12	16 in dia	\$152.95
5-1544413-670	Rounds - Set of 24	16 in dia	\$245.95





Carpets for  
**KIDS**®  
etc...  
When Quality Counts!



**No Fault Edge Warranty™**

**Carpets for Kids® Fun with Phonics Seating Carpet**

Teaches the alphabet while providing plenty of wiggle room. The cute, related phonics images make this a fun place for children of all ages to learn. Add the Fun with Phonics Squares to create more learning fun!

Item #	Description	Product Dimensions	List Price
5-679225-670	Rectangle	7 ft 6 in x 12 ft	\$595.95
6-679226-670	Rectangle	8 ft 4 in x 13 ft 4 in	\$722.95
5-679227-670	Semi-Circle	5 ft 10 in x 11 ft 8 in	\$503.95
5-679228-670	Semi-Circle	6 ft 8 in x 13 ft 4 in	\$677.95
5-679229-670	Oval	8 ft 3 in x 11 ft 8 in	\$702.95
5-679230-670	Squares - Set of 26	12 in x 12 in	\$233.95



**Carpets for Kids® Colorful Places Seating Carpet**

These simple, colorful carpets are great for classroom organization. Each colored space makes a perfect place for children to sit and have plenty of wiggle room, all while being surrounded by a literacy border.

Item #	Description	Product Dimensions	List Price
5-1536817-670	Rectangle - Seats 25	6 ft x 9 ft	\$460.95
5-679223-670	Rectangle - Seats 30	7 ft 6 in x 12 ft	\$595.95
6-679222-670	Rectangle - Seats 30	8 ft 4 in x 13 ft 4 in	\$722.95
5-679224-670	Oval	8 ft 3 in x 11 ft 8 in	\$702.95

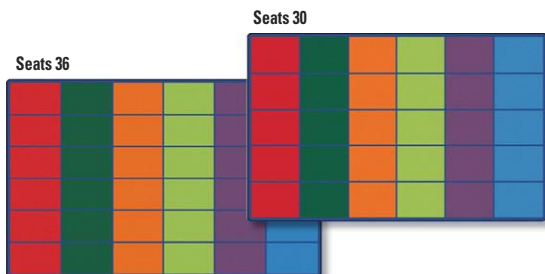

**Carpets for Kids® Colorful Rows Seating Carpet**

Colorful rows provide space for 25, 30, or 36 students.

Item #	Description	Product Dimensions	List Price
5-1536818-670	Rectangle - Seats 25	6 ft x 9 ft	\$460.95
5-2102594-670	Rectangle - Seats 30 <b>NEW</b>	7 ft 6 in x 12 ft	\$595.95
6-1463579-670	Rectangle - Seats 30	8 ft 4 in x 13 ft 4 in	\$722.95
6-1467834-670	Rectangle - Seats 36	8 ft 4 in x 13 ft 4 in	\$722.95

**Carpets for Kids® Seating Circles Carpet**

Rows of primary-colored circles create a fun place for kids of all ages to sit and learn. Choose from 30 spaces or our largest size featuring 36 spaces for the ultimate in classroom organization!

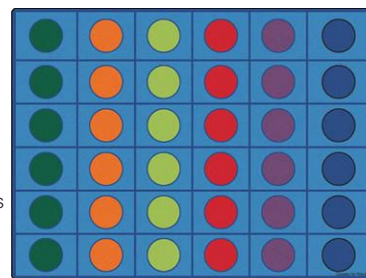

Item #	Description	Product Dimensions	List Price
5-1495441-670	Rectangle - Seats 30	6 ft x 9 ft	\$460.95
5-2102597-670	Rectangle - Seats 30 <b>NEW</b>	7 ft 6 in x 12 ft	\$595.95
5-1495442-670	Rectangle - Seats 30	8 ft x 12 ft	\$678.95
6-1495443-670	Rectangle - Seats 36	10 ft x 13 ft 6 in	\$876.95



**Carpets for Kids® Learning Blocks Carpet**

Letters, numbers, shapes; these carpets have it all! The perfect design for learning activities including literacy, shape and number recognition, and even more advanced matching skills.

Item #	Description	Product Dimensions	List Price
5-1365776-670	Rectangle, Primary Colors	4 ft 5 in x 5 ft 10 in	\$255.95
5-1365777-670	Rectangle, Primary Colors	5 ft 10 in x 8 ft 4 in	\$432.95
5-1365780-670	Rectangle, Primary Colors	8 ft 4 in x 11 ft 8 in	\$702.95
5-1365778-670	Oval, Primary Colors	6 ft 9 in x 9 ft 5 in	\$460.95
5-1365779-670	Oval, Primary Colors	8 ft 3 in x 11 ft 8 in	\$702.95
5-1467813-670	Squares - Set of 26, Primary	12 in x 12 in	\$233.95
5-1468367-670	Rectangle, Neutral	4 ft 5 in x 5 ft 10 in	\$255.95
5-1468366-670	Rectangle, Neutral	5 ft 10 in x 8 ft 4 in	\$432.95
5-1468368-670	Oval, Neutral	6 ft x 9 ft	\$460.95
5-1468369-670	Oval, Neutral	8 ft 3 in x 11 ft 8 in	\$702.95
5-1467814-670	Squares - Set of 26, Neutral	12 in x 12 in	\$233.95



**Carpets For Kids® KID\$Value PLUS™ All The Animals Literacy Seating Carpet**

A seat for everyone with these adorable animals, shapes, and colors to help kids with physical distancing seating. The letters of the Alphabet are printed around the rug for literacy practice. 5-Year Limited Abrasive Wear Warranty.

Item #	Description	Product Dimensions	Color	List Price
5-2102605-670	Oval	6 ft x 9 ft	Multicolored	\$285.95
6-2102599-670	Oval	7 ft 6 in x 12 ft	Multicolored	\$535.95





ENTIRE PAGE  
**NEW**



PRODUCT CERTIFIED FOR LOW CHEMICAL EMISSIONS: UL.COMMGG UL 2818



**Wood Designs™ Outdoor Furniture Collection**

- Constructed from durable and nontoxic wood
- Edges and corners rounded for safety
- Acetylated wood resists shrinking, warping, and rotting
- Stainless-steel hardware

**Wood Designs™ Outdoor Thunderwalls**

These alternative outdoor sensory walls are designed to create responsive thunder-like sounds. Have your children experiment and produce a range of sounds effects by tapping, banging, and pounding the durable metal sheet. **Professionally implanting into the ground is required.**



Item #	Description	Product Dimensions	List Price
6-2104363-670	Junior Outdoor Thunderwall	30 W x 8 D x 48 H in	\$1,704.95
6-2104362-670	Outdoor Thunderwall	30 W x 8 D x 72 H in	\$2,383.95



**Wood Designs™ Outdoor Garden Center**

This Garden Center with roof and flower beds allow children to create their own flower garden. Requires assembly.

Item #	Description	Product Dimensions	List Price
6-2104365-670	Outdoor Garden Center	77 W x 75 D x 80 H in	\$5,797.95

**Wood Designs™ Outdoor Sand and Water Table**

Provide a natural place to play, discover and explore outside with this kid-sized sand and water table. Features a large removable tan bin and faucet with ample space for children to gather and play. Fully assembled.



Item #	Description	Product Dimensions	List Price
6-2104447-670	Outdoor Sand and Water Table	41 W x 27 D x 25 H in	\$1,032.95

**Wood Designs™ Outdoor Activity Center**

Gather children around this large tabletop where you can teach topics about the outdoors in the elements! Includes a removable crate for storage and four sliding and removeable drawers. Fully assembled.



Item #	Description	Product Dimensions	List Price
6-2104364-670	Outdoor Activity Center	54 W x 19-1/4 D x 24 H in	\$2,891.95



**Wood Designs™ Outdoor Farmhouse Sink and Hutch**

This kid-sized farmhouse sink features a large removable white liner with ample space to get your hands dirty and a lower shelf for storage. Hutch provides two additional shelves for storage. The Farmhouse Sink comes fully assembled. Hutch requires some assembly. Plastic tub has 1-year warranty.

Item #	Description	Product Dimensions	List Price
6-2104446-670	Farmhouse Sink	54 W x 22-1/2 D x 24 H in	\$1,230.95
6-2104445-670	Farmhouse Sink Hutch	52 W x 5-1/2 D x 20 H in	\$316.95



**Wood Designs™ Outdoor Bench With Storage**

This bench's kid-friendly size offers ample seating and storage. Fully assembled.

Item #	Description	Seat Height	List Price
6-2104360-670	Outdoor Bench w/ Storage	18 in	\$1,111.95

# CHILDCRAFT®

A School Specialty® Exclusive

School Specialty®  
**exclusive**

## Childcraft® Tricycles

Every child loves the freedom to get around on this trike. It's easy to move forward, trains the muscles, and develops motor skills. These Childcraft® trikes feature:

- Smooth, heavy-duty tube construction
- Durable powder-coated frame, front fork, and handlebar
- No pinch point, built-in steering limiter.
- Polypropylene pedals and spokeless wheels
- Solid rubber tires and handlebar grips
- Weather resistant polyethylene seat
- Current safety standard compliance
- Easy assembly
- Maximum weight capacity 160 lbs.
- Full spare parts service
- 5-year warranty on frame and fork



Item #	Description	Product Dimensions	Age Range	List Price
5-1398979-670	10 in Tricycle	10 in H	2 - 4 years	\$232.95
5-1398980-670	12 in Tricycle	12 in H	3 - 6 years	\$256.95
5-1398981-670	14 in Tricycle	14 in H	4 - 8 years	\$288.95

**5-Year Warranty**

## Childcraft® EasyRider

The lower seat makes this cool trike perfect for young low riders. Handlebar height 22". Seat Height 7 1/2". Maximum weight capacity 160 lbs. Features 5-year warranty on frame and fork.

Item #	Description	Product Dimensions	Age Range	List Price
5-1398982-670	Easy Rider	7-1/2 in H	4 - 7 years	\$357.95

## Childcraft® Safety Roller

This fun Safety Roller provides maximum stability. This makes it ideal for children who need to develop their balance and motor skills, as well as for children with reduced capabilities. Maximum weight capacity 110 lbs.



## Childcraft® Child Taxi

A taxi is lots of fun and provides many great play ideas. Children will love testing their imaginations and role-playing with their friends. Height to seat: 13-3/4". Maximum weight capacity 220 lbs.

Item #	Description	Product Dimensions	Age Range	List Price
5-1499056-670	Safety Roller	32 L x 19 W x 30 H in	3 - 7 years	\$317.95
5-1499057-670	Child Taxi	43-1/2 L x 25 W x 24 H in	3 - 7 years	\$484.95



## ABC® Tricycles

Even the smallest children can ride! These tricycles provide children with lots of fun while developing and exercising their motor skills. All easy-to-assemble trikes feature:

- Safe design with rounded shapes, no sharp edges
- Anatomical seat design
- Safety handlebar grips
- Strong, non-slip pedals with steel crank
- Spokeless wheels with wide tires
- Nylon bearings for both front and rear wheels
- Durable powder coating
- Full spare parts service
- Current safety standard compliance
- 3-year warranty on frame and fork
- Maximum weight capacity 110 lbs.

**3-Year Warranty**

Item #	Description	Product Dimensions	Age Range	List Price
5-1398983-670	Low	9-3/4 in Seat Height	1 - 4 years	\$218.95
5-1398984-670	Medium	11-3/4 in Seat Height	2 - 4 years	\$218.95





PRODUCT CERTIFIED FOR LOW CHEMICAL EMISSIONS: UL.COM/IGG UL 2818



**CHILDCRAFT®**  
A School Specialty Exclusive



Available in toddler height

**Childcraft® Mobile Mini Sand and Water Table Package**

Solid maple construction with see-through heavy-duty acrylic tub (tub has a bluish tint), heavy-duty drain faucet, dual wheel locking casters. Complete package includes: table with cover and sand and water play set. Assembled, except for casters. 22 lbs.

Item #	Description	Product Dimensions	List Price
5-071898-670	Table without Cover	30 W x 19-1/4 D x 22-3/16 H in	\$719.95
5-296591-670	Table w/Cover	31-5/8 W x 19-3/4 D x 22-13/16 H in	\$850.95
5-296669-670	Complete Package	31-5/8 W x 19-3/4 D x 22-13/16 H in	\$895.95
5-1485839-670	Replacement Clear Tub w/Faucet	30 W x 18 D x 8 H in	\$327.95
5-075030-670	Replacement Cover	31-5/8 W x 19-3/4 D in	\$236.95

**Childcraft Sand and Water Play Kit**

Item #	Description	Age Range	Quantity	List Price
9-1302119-670	Sand and Water Play Set	2+ years	Set of 35	\$146.69

**Childcraft® Mobile Mini Square Sand & Water Table With Cover**

Maximum fun in a smaller version of our very popular sand and water table. Perfect for those small spaces, rolls easily and stays in place with locking casters. Includes durable clear tub, cover and rubber drain plug. Assembled, except for casters.

Item #	Description	Product Dimensions	List Price
5-1491071-670	Toddler Height	23-1/4 W x 23-1/4 D x 21 H in	\$632.95
5-1491069-670	Standard Height	23-1/4 W x 23-1/4 D x 24 H in	\$632.95
5-1554148-670	Replacement Tub w/Plug	20W x 20D x 9H in	\$403.95



Clear Tub



Package with Clear Tub



Clear Tub with Shelf



Standard Grid Top



With Wood Cover and White Tub

**Childcraft® Sand and Water Tables**

Large, versatile table holds either sand or water; use the cover to convert it to a classroom work table. Also available with a shelf that provides extra storage space. Shelf, grid tops, and replacement tubs also available separately. Standard grid top can be used with smaller-size building bricks. Most preschool-sized bricks will fit standard grid. Grid colors can vary. Clear acrylic cover now available.

**Package includes:** Sand and Water Table with Clear Tub, Wood Cover, 2 Large Storage Tubs, and the Sand and Water Accessories shown in picture.

**Assembly required.**

Item #	Description	Product Dimensions	List Price
<b>Without Shelf</b>			
5-296099-670	Table w/Clear Tub	42-3/8 W x 30-1/8 D x 23-1/2 H in	\$899.95
5-295991-670	Table w/White Tub	42-3/8 W x 30-1/8 D x 23-1/2 H in	\$899.95
5-296129-670	Table w/Clear Tub, Cover	42-3/8 W x 30-1/8 D x 23-1/2 H in	\$1,078.95
5-306600-670	Table w/White Tub, Cover	42-3/8 W x 30-1/8 D x 23-1/2 H in	\$1,078.95
<b>With Shelf</b>			
5-296585-670	Table w/Clear Tub, Shelf	42-3/8 W x 30-1/8 D x 23-1/2 H in	\$1,078.95
5-296630-670	Table w/Clear Tub, Shelf, Cover	42-3/8 W x 30-1/8 D x 23-1/2 H in	\$1,332.95
5-296633-670	Table w/White Tub, Shelf, Cover	42-3/8 W x 30-1/8 D x 23-1/2 H in	\$1,332.95
<b>Package</b>			
5-268185-670	Sand and Water Table Package	42-3/8 W x 30-1/8 D x 23-1/2 H in	\$1,368.95
<b>Accessories</b>			
5-271906-670	Shelf	42-3/8 W x 26-5/8 D x 1-3/4 H in	\$282.95
5-074951-670	Wood Cover	42-3/8 W x 30-1/8 D in	\$317.95
5-2005790-670	Clear Acrylic Cover	42 W x 30-1/8 D x 1 H	\$167.95
5-271753-670	Standard Grid Top	42-3/8 W x 30-1/8 D in	\$480.95
5-075012-670	Replacement Clear Tub w/Faucet	38-3/4 W x 25-1/8 D x 9 H in	\$612.95
5-075011-670	Replacement White Tub w/Faucet	38-3/4 W x 25-1/8 D x 9 H in	\$612.95

**QUICKSHIP** 24 HRS 48 HRS 1 OR 2 WEEKS  
Items ship within 24 hrs, 48 hrs, 1 or 2 weeks as indicated when the factory distribution center receives the order.

Items ship **Freight** or **Parcel** See Shipping & Handling terms for details.





PRODUCT CERTIFIED FOR LOW CHEMICAL EMISSIONS: UL COMPOS UL 2818



Thermographic pad



### Childcraft® Mobile Sensory Science Center

Mobile unit has two deep tubs and a thermographic pad on top, storage shelves on two sides and six slots with tactile frames that slide in each one. Tactile frames include: plush carpet, sequin surface, artificial grass, corkboard, acrylic mirror and a rough surface. Dual-wheel locking casters. Assembled.

Item #	Description	Product Dimensions	List Price
5-2024272-670	Science Center w/frames	35-3/4 W x 29-3/4 D x 24 H in	\$1,621.95
<b>Additional Sensory Frames,</b>			
9-2023275-670	Sensory Panel - Turf Grass	15 L x 15 W x 3/4 H in	\$100.99
9-2023274-670	Sensory Panel - Velcro Hooks	15 L x 15 W x 3/4 H in	\$101.99
9-2023277-670	Sensory Panel - Cork	15 L x 15 W x 3/4 H in	\$109.99
9-2023276-670	Sensory Panel - Carpet	15 L x 15 W x 3/4 H in	\$111.99
9-2023278-670	Sensory Panel - Sequins	15 L x 15 W x 3/4 H in	\$120.99
9-2020861-670	Sensory Panel - Mirror	15 L x 15 W x 3/4 H in	\$120.99

### Childcraft® Mobile Science Exploration Table

This mobile unit includes two specimen observation boxes and two removable mirrored viewing boxes on top and four storage spaces below. Heavy-duty casters. Assembled.



Item #	Description	Product Dimensions	List Price
5-1464159-670	Science Exploration Table	47-3/4 W x 14-1/4 D x 24 H in	\$501.95

Remove legs for tabletop use!



### Childcraft® LED Mini Light Table

Freestanding light table with storage shelf below can be used on the floor with the legs or on a table without the legs. UL-approved, electrical components. Assembled required.



Item #	Description	Product Dimensions	List Price
5-1589409-670	Mini Light Table	21-1/2 W x 23-1/2 D x 20 H in	\$624.95

### Childcraft® Mobile Makerspace Cart

Mobile storage cart features three shelves on one side and half pegboard/half magnetic whiteboard on the other side. The top two shelves are tilted for easy storage bin removal and four pegboard bins are included as well. The top includes a whiteboard banner to add a message or label and easy-to-grasp cutout handles to aid in moving the cart. Assembly required.



Item #	Description	Product Dimensions	List Price
6-2020827-670	Makerspace Cart	48-1/4 W x 22-1/2 D x 49 H in	\$1,505.95
6-2024131-670	With Translucent/Primary Trays	48-1/4 W x 22-1/2 D x 49 H in	\$1,764.95
6-2024132-670	With Translucent Trays	48-1/4 W x 22-1/4 D x 49 H in	\$1,764.95



Set



Storage Dolly



Sensory Module



Magnifier with Stand



Soil & Water Module



Magnification Module



Habitat & Terrarium Module

### Childcraft® Mobile Stacking Science Modules

Set of four science modules include:

- Soil & Water Module with removable clear tray
- Sensory Module with two cutouts to insert hands and feel what is inside
- Magnification Module with two 5" diameter magnifiers
- Habitat & Terrarium Module with clear sides for easy viewing and a removable lid
- Mobile Storage Dolly with heavy duty, locking casters

Modules nest for stacking and include easy-to-grasp cutout handles on the sides. Assembled..

Item #	Description	Product Dimensions	List Price
5-1537070-670	Stacking Science Module Set	-	\$645.95
5-1528648-670	Soil & Water Module	19-1/2 W x 10 D x 10-1/4 H in	\$133.95
5-1528650-670	Habitat & Terrarium Module	19-1/2 W x 10 D x 10-1/4 H in	\$137.95
5-1528652-670	Sensory Module	19-1/2 W x 10 D x 10-1/4 H in	\$137.95
5-1528649-670	Magnification Module	19-1/2 W x 10 D x 10-1/4 H in	\$173.95
9-1528653-670	Mobile Storage Dolly	19-1/2 W x 20-1/2 D in	\$133.95
9-1305186-670	Magnifier with Stand	11-7/8 Wx11-7/8 Dx13-1/4 H in	\$133.95



PRODUCT CERTIFIED FOR LOW CHEMICAL EMISSIONS: UL.COM/CGG UL 2818



Standard Activity Center with Clear Trays



Dry-Erase Panel with Translucent Color Trays

### Childcraft® Collaboration Multi-Purpose Table

This mobile collaboration table is great for a wide range of activities and is available in two heights. Included removable building base top is available with preschool or standard sized grids. Without the building base top, the large surface is ideal for building blocks, puzzles and construction play. A raised edge along the top keeps pieces from sliding off the table. Cubby spaces fit trays sized 11"W x 16"D x 6"H. Bricks sold separately. Grid colors can vary. Assembled.

Item #	Description	Top Height	List Price
<b>Preschool Grid Table - 30-3/4 in Square x 24 in H</b>			
6-2003912-670	Preschool Top Table	21-5/8 in	\$1,066.95
6-2006091-670	With 8 Assorted Color Trays	21-5/8 in	\$1,214.95
6-2006094-670	With 8 Translucent Trays	21-5/8 in	\$1,214.95
<b>Standard Grid Table - 30-3/4 in Square x 30 in H</b>			
6-2003913-670	Standard Top Table	27-5/8 in	\$1,199.95
6-2006093-670	With 12 Assorted Color Trays	27-5/8 in	\$1,419.95
6-2006092-670	With 12 Translucent Trays	27-5/8 in	\$1,419.95

### Childcraft® Dual-Sided Building-Brick Activity Center

This dual-sided activity center is convenient for multiple kids to collaborate and use their imaginations! Choose from standard panels for standard bricks or preschool panels for large bricks. The reverse side has a magnetic dry-erase board. Cubby spaces fit trays or baskets sized 7-3/4" W x 12" D x 5-1/4" H. Bricks sold separately. Assembled.

Item #	Description	List Price
<b>Standard-Grid Panels - 39-1/2 W x 14-1/4 D x 30 H in</b>		
5-2020828-670	Standard Activity Center	\$889.95
5-2024270-670	With 4 Translucent Color Trays	\$924.95
5-2024276-670	With 4 Primary Color Trays	\$924.95
5-2024278-670	With 4 Clear Trays	\$924.95
5-2024280-670	With 4 Baskets	\$987.95
<b>Preschool-Grid Panels - 39-1/2 W x 14-1/4 D x 30 H in</b>		
5-2021250-670	Preschool Activity Center	\$889.95
5-2024279-670	With 4 Translucent Color Trays	\$924.95
5-2024271-670	With 4 Primary Color Trays	\$924.95
5-2024275-670	With 4 Clear Trays	\$924.95
5-2024273-670	With 4 Baskets	\$987.95



Play Table with Baskets



Building Top with Assorted Color Trays

### Childcraft® Toddler Multi-Purpose Play Table

The removable building-base top creates a building space, or the mirror top adds new dimension to learning. Raised edges along the top keep pieces from slipping off the table. Six cubby spaces below fit trays sized 7-3/4"W x 12"D x 5-1/4"H. Simple screw assembly required.

Item #	Description	Top Height	List Price
<b>Play Table</b>			
5-1464164-670	Play table	18 in	\$615.95
<b>With Building Top</b>			
5-1468532-670	Table With Building Top	18 in	\$726.95
5-1539301-670	With 6 Assorted Color Trays	18 in	\$779.95
5-1539300-670	With 6 Clear Trays	18 in	\$779.95
5-1537348-670	With 6 Baskets	18 in	\$874.95
<b>Replacement Tops</b>			
5-1464165-670	Replacement Building Top	-	\$191.95

### Childcraft® Block Tables

Large building grid surface for several children to work together. Built-in storage for hundreds of bricks. Choose preschool top for large bricks and standard top for smaller bricks. Buy the units with the cover to create a solid surface that makes this table versatile. Cover is also sold separately to add to an existing table. Bricks sold separately. Grid colors can vary.

Preschool Grid



Table With Cover

Item #	Description	Top Height	List Price
<b>Preschool Grid - 32-1/4 in Square</b>			
5-249480-670	Preschool Top Block Table	24-3/16 in	\$664.95
5-1537065-670	Preschool Top Table With Cover	24-3/16 in	\$892.95
<b>Standard Grid - 32-1/4 in Square</b>			
5-249477-670	Standard Top Block Table	24-3/16 in	\$664.95
5-1537066-670	Standard Top Table With Cover	24-3/16 in	\$892.95
<b>Accessories</b>			
5-1528596-670	Building Table Cover	-	\$327.95





**CHILDCRAFT®**  
A School Specialty® Exclusive



Sink & Dishwasher Combo



Refrigerator



Stove & Microwave Combo



PRODUCT CERTIFIED FOR LOW CHEMICAL EMISSIONS:  
UL COMF55  
UL 2818



Complete 3-Piece Set.  
Chairs sold separately.

**Childcraft® Modern Kitchen Set**

A modern twist on play furniture. Stylish island version of a sink/dishwasher/dining area combo features knobs that turn and a 2-shelf dishwasher. The 22" counter height works best with a 10" or 12"H chair. Minor assembly required. Apartment-style stove and microwave unit features sturdy self-closing hinges and shelf for baking. Refrigerator features shelves, slim handles, and realistic ice/water dispenser in door.

Item #	Description	Product Dimensions	List Price
5-1491227-670	Refrigerator	23-3/4 W x 16-3/4 D x 42 H in	\$566.95
5-1491224-670	Stove & Microwave Combo	21-1/4 W x 15-5/8 D x 42 H in	\$632.95
6-1491222-670	Sink & Dishwasher Combo	43-1/2 W x 29-3/4 D x 4-3/8 H in	\$1,135.95
6-1497601-670	Complete 3-Piece Set	-	\$2,100.95

Includes: refrigerator, stove & microwave combo, and sink & dishwasher island combo

Item #	Description	Seat Height	Quantity	List Price
5-2095345-670	Ladderback Chair	10 in	Set of 2	\$299.95
5-2095347-670	Ladderback Chair	12 in	Set of 2	\$325.95
5-2095348-670	Ladderback Chair	14 in	Set of 2	\$347.95
5-2095346-670	Ladderback Chair	16 in	Set of 2	\$368.95



**Childcraft® Modern Compact Kitchen**

The Modern Compact Kitchen helps promote social skills through imaginative play. The stove features four burners and smoke colored shatterproof acrylic top, five rotating dials and a functional oven door with a clear acrylic window. Realistic faucet and sink with plenty of space for food and play dishes, including storage below the sink. Assembled.

Item #	Description	Product Dimensions	List Price
6-2041378-670	Modern Kitchen	47-3/4W x 14-1/2D x 27-3/4H in	\$1,108.95

**Childcraft® Toddler Kitchen Set**

This 4-piece kitchen set is built especially for toddlers. Encourage imaginative play with a realistic stove and sink with knobs that turn. Plenty of storage for play food and dishes. Shaped edges and rounded corners for safety. Three-coat, UV-cured, acrylic finish holds up to repeated cleanings and resists marks from pens, paints, crayons, solvents, cleaners, and bleach making it easy to wipe clean!

Item #	Description	Product Dimensions	List Price
5-271468-670	Toddler Kitchen Refrigerator	12 1/2 W x 13 1/4 D x 28 H in	\$240.95
5-271465-670	Toddler Kitchen Stove	18 W x 13 3/8 D x 21 1/2 H in	\$240.95
5-661731-670	Toddler Kitchen Sink	18 W x 13 3/8 D x 21 1/2 H in	\$240.95
5-661730-670	Toddler Kitchen Hutch	18 W x 13 3/8 D x 26 9/16 H in	\$240.95
6-2094844-670	Complete 4-Piece Set	-	\$867.95

Includes: refrigerator, stove, sink, and hutch

**NEW**



Sized for  
**Toddlers**







PRODUCT CERTIFIED FOR LOW CHEMICAL EMISSIONS: UL-COM1GG UL-2818



### Childcraft® Complete Traditional Kitchen Set

Knobs that turn and a swiveling faucet offer realistic role play. These classic kitchen units have plastic laminate tops for easy clean-up and maintenance, solid doors with sturdy hinges to prevent pinching small fingers, and shaped edges and rounded corners for safety. Individual pieces arrive fully assembled.



Item #	Description	Product Dimensions	List Price
5-1386210-670	<b>A</b> Hutch	24 W x 13-3/8 D x 40-7/8 H in	\$466.95
5-074514-670	<b>B</b> Traditional Sink	24 W x 13-3/8 D x 27-3/4 H in	\$466.95
5-074511-670	<b>C</b> Traditional Stove	24 W x 13-3/8 D x 27-3/4 H in	\$466.95
5-1464143-670	<b>D</b> Stove & Microwave Combo	24 W x 13-3/8 D x 40-7/8 H in	\$506.95
5-386499-670	<b>E</b> Traditional Refrigerator	19 W x 13-1/4 D x 38 H in	\$466.95
5-074979-670	<b>F</b> Straight Kitchen Connector	24 W x 11-1/4 D in	\$196.95
5-074558-670	<b>G</b> Corner Kitchen Connector	24-5/8 W x 24-5/8 D in	\$323.95
6-296120-670	4-Piece Set #1	-	\$1,679.95
Includes: sink, hutch, stove, and refrigerator			
6-1474931-670	4-Piece Set #2	-	\$1,715.95
Includes: sink, hutch, stove & microwave combo, and refrigerator			
6-1472127-670	Complete 7-Piece Set	-	\$2,360.95
Includes: sink, hutch, stove & microwave combo, refrigerator, 2 straight connectors, and 1 corner connector			



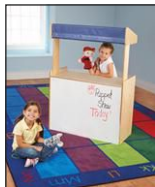

Puppet Theater



With Colored Trays

Versatile market stand doubles as a play store and a puppet theater!



Tan & White Curtain Set

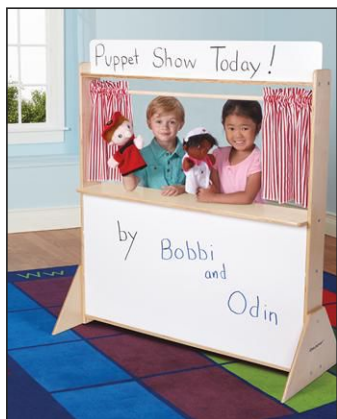

With 1-Sided Dry-Erase Panel



Rear View with 1-Sided Dry-Erase Panel

**Childcraft® Market Stand**

This market stand features a blue awning, sales counter, and two shelves for storage. Large magnetic dry-erase panel allows children to name their store and feature specials! This unit also doubles as a puppet theater. Available with trays or baskets sized 16"L x 11"W x 6"D. Baskets are washable and include detachable pouch for identification. Minimal assembly required; hardware and instructions included. Play food and accessories sold separately.

**Childcraft® Play Store and Puppet Theater**

Double-sided unit features a puppet stage on one side and store on the other. Includes red and white striped curtains. Tan and white striped curtains sold separately. Minimal assembly required; hardware and instructions included. 41 lbs.

Item #	Description	Product Dimensions	List Price
5-1557195-670	Stand with Canopy	35-3/4 W x 16 D x 49-7/8 H in	\$532.95
5-1568769-670	With Assorted Color Trays	35-3/4 W x 16 D x 49-7/8 H in	\$578.95
5-1568770-670	With Clear Trays	35-3/4 W x 16 D x 49-7/8 H in	\$578.95
5-1568771-670	With Baskets	35-3/4 W x 16 D x 49-7/8 H in	\$622.95

Item #	Description	Product Dimensions	List Price
5-1472489-670	With Dry-Erase Panels	45-1/2 W x 19-1/2 D x 50-3/4 H in	\$626.95
9-1471469-670	Tan & White Curtain Set	18 W x 22 H in	\$92.95



**Childcraft® Dress-Up Carousel Storage**

This Dress-Up Carousel is compact and easy to rotate. It has plenty of storage for all dress-up clothes, costumes, and accessories. One side features 6 aluminum hooks for hanging costumes and capes! The other side features 4 cubby shelves to store scarves, shirts, hats and more. Shatterproof mirrors on each side. Shelves can hold 2 storage trays sized 10"W x 13"D x 5"H or 10"W x 13"D x 3"H. Sold separately. Assembled.



**Childcraft® Dress-Up Storage Unit**

The perfect place to store costumes and accessories, with easy access from either side to items hanging on hooks. Top shelf is great for hats, bottom well keeps shoes and other items in place, and 6 side shelves hold storage totes to keep accessories organized. Totes measure 16"L x 11"W x 6"D and are sold separately. Acrylic mirror measures 11"W x 36"H. Assembled. 90 lbs.

Item #	Product Dimensions	Number of Hooks	Mobile	List Price
6-2040253-670	29-1/2 W x 29-1/2 D x 42 H in	6	No	\$866.95

Item #	Product Dimensions	Number of Hooks	Mobile	List Price
6-074588-670	47-3/4 W x 16 D x 42 H in	5	No	\$918.95

## A

Activity Tables.....	62-73, 103, 203, 351-352
Air Purifiers.....	273
<b>Art</b>	
Clay Carts & Wedging Boards.....	85
Clay Drying Cabinets.....	85
Drying Racks.....	88-89, 91
Easels.....	89-90, 340, 343
Kilns and Accessories.....	87
Pottery Wheels.....	86
Storage.....	84-85, 88
Tables.....	83

## B

<b>Benches</b>	
Outdoor.....	286-288, 296
Bleachers.....	290
<b>Boards</b>	
Bulletin.....	151, 153, 155, 161, 164
Cork.....	153, 161
Directory and Message.....	163-164
Glass.....	147-148, 158
Lap.....	154, 160
Magnetic.....	147-152, 154, 158-160
Marker.....	147-152, 154, 158-162, 268
Projection.....	149
Resurfacing.....	156-157
Reversible.....	158-162
Tack.....	151, 153

## C

<b>Cabinets</b>	
Filing.....	211, 216, 240-242
Fireproof Filing.....	242
Metal.....	260-263, 279
Mobile.....	102, 108, 246, 262, 324, 331
Storage.....	102, 108-109, 112, 246, 250-252, 260-263, 324, 331
Tote Tray.....	45, 48-49, 56, 70, 110, 248-249, 253-255, 324-325
Wall.....	262, 279, 331
Wardrobe.....	261, 331
Wood.....	102, 246, 324, 330-331
Caddies, Folding Chair.....	204, 206, 208-209
Caddies, Folding Table.....	201
<b>Cafeteria &amp; Food Court</b>	
Bench Units.....	185-189
Booths.....	186-187
Café Tables and Chairs.....	195-199
Convertible Bench Units.....	185
Mobile Sinks.....	200
No Seating Units.....	192-194
Receptacles.....	200
Stool Units.....	190-191
Utility Carts.....	200
<b>Califone</b>	
Headphones / Headsets.....	124-125, 127-131
Listening Centers.....	132
PA System.....	123
<b>Cameras</b>	
Digital Cameras.....	133
<b>Carts</b>	
Art.....	85, 88-89, 91, 343
Audio Visual.....	120
Book.....	338-339
Clay.....	85
Presentation.....	142-144
TV.....	120
Utility.....	200, 269-270
<b>Chairs</b>	
Active Seating.....	9-13, 182, 349, 353
Ball Chairs.....	182

Bean Bags.....	174, 355
Cafeteria.....	198-199, 209
Classroom.....	14-35, 92-93, 348-350
Executive.....	224, 226, 228-229, 231-233
Folding.....	204-207
Gaming.....	224, 229
Guest.....	222, 232-233
Lounge.....	221
Music.....	92-93
Primary and Toddler.....	348, 354, 376
Stack.....	11, 31, 198, 208-209, 348, 350
Stools.....	9-12, 29-31, 33-34, 101, 107, 198-199, 209, 234-235, 279, 349
Task.....	223-235
Wooden.....	348

## Childcraft

Art.....	88-89
Audio Visual.....	332
Benches.....	325
Block Play and Storage.....	327, 375
Brick Activity Center.....	375
Carpets.....	359-366
Chairs.....	348, 353
Cots.....	358
Cubby Units.....	316-322
Dramatic Play / Kitchen Furniture.....	376-378
Easels.....	89, 337, 343
Literacy.....	312, 332-337, 348
Locker Units.....	316-318
Lofts.....	346
Portable Sink.....	200
Sand and Water Tables.....	373
Science Exploration.....	373-374
Seating.....	348, 353-355
STEM.....	332
Step Stool.....	344
Storage.....	320-322, 325-331, 335-336, 356
Tables.....	347-348
Tricycles.....	372
Writing Centers.....	332, 348
Choral Risers.....	94-95

## Classroom

Active Desks.....	52-53, 55, 59
Chair & Desk Accessories.....	16-19, 24-25, 36-41, 44-45, 48-50, 55-57
Soft Seating.....	12, 354-355
Standing Desks.....	53-59
Stools.....	9-12, 29-31, 33-34, 101, 107, 209, 269, 349
Student Chairs.....	14-27, 35, 349-350, 354
Student Desks.....	35-59, 350
Tables.....	62-83, 96-97, 103-105, 347-348, 350-352

## Classroom Select

Activity Tables.....	62-81, 96-97, 103-105, 351-352
Bookcases.....	216, 238, 248
Cafeteria Tables.....	185-199
Classroom Chairs.....	14-30, 35, 209, 349-350
Classroom Desks.....	35-58, 350
Computer Tables.....	78-79
Filing Cabinets.....	211, 216, 240
Makerspace.....	103-105, 107-109, 160
Music Chairs.....	92
Office Chairs.....	222-235
Office Suites.....	214-216
Recovery Lounge.....	279
Soft Seating.....	166-175
Stools.....	9-12, 29-31, 101, 107, 198-199, 209, 231, 234, 279, 353
Storage.....	108-110, 112, 170, 211, 216, 240, 244, 246, 248-249, 253-256
Teacher's Desks.....	210-211
Utility Carts.....	200, 270

## Combination Locks

Built-in Locks.....	278
---------------------	-----



Padlocks..... 278

**Common Area - Media**

Childcraft Tables and Benches..... 353

Privacy Panels..... 312

Soft Seating..... 166-176, 354-355

**D**

**Desks**

Accessories ..... 36-41, 44-45, 48-50, 55-57

Classroom ..... 35-59, 82, 350

Office ..... 214-218

Stand Up ..... 53-59, 82, 213

Teachers..... 210-211

**Display**

Cases..... 165

Rails..... 155

**Dollies**

Chair ..... 11, 14, 16-20, 22-25, 31, 93, 204, 206, 208-209, 349-350

Desk ..... 35

Folding Chair ..... 204, 206

Music Stand ..... 93

Stage ..... 93

Dry Erase Markers ..... 154

**E**

**Early Childhood**

Activity Tables & Chairs..... 348

Benches..... 305, 316, 325, 371

Book Storage..... 338

Brick Activity Center ..... 375

Carpets / Carpet Squares & Rounds..... 359-370

Chair / Sofa ..... 353

Cots / Sheets / Blankets ..... 356, 358

Cubbies ..... 319-322

Dramatic Play / Kitchen Furniture..... 376-378

Easels ..... 337, 339-343

Literacy Furniture..... 312, 333-337, 348

Lockers..... 316-318

Metal Literacy ..... 338

Outdoor..... 371

Portable Sink ..... 344

Rest Mat Storage..... 356

Rest Mats ..... 356-357

Rocker ..... 353

Sand & Water Tables..... 373

Science Exploration..... 373-374

Seating..... 13, 349-350, 353-355

Soft Seating..... 354-355

Stations..... 339-340, 342

STEM ..... 332

Step Stools..... 344

Storage ..... 319-331, 335-337

Storage Trays..... 323

Wood Tables & Chairs ..... 347-348

Writing Center ..... 332, 341

**Easels**

Art..... 89-90, 340-343

Dry Erase / Markerboard..... 89, 160, 162, 337-343

Magnetic ..... 162, 337

Metal ..... 90, 343

Tabletop ..... 90, 340

**Educational Technology**

3D Printing ..... 112-114

Charging Carts..... 139-141

Digital Cameras..... 133

Document Camera ..... 122

Headphones ..... 124-131

Interactive Technology ..... 115-118

Lecterns ..... 145-146

Listening Centers & Accessories ..... 132

PA System ..... 123

Presentation Carts..... 142-144

Projectors..... 121

Promethean..... 117

TV Carts ..... 120

TV's ..... 119

**F**

**Facility Furnishings**

Carts..... 269-270

Floor Mats ..... 271

Lockers..... 266

Material Handling..... 269

Room Dividers..... 267-268, 312, 345

Shelving..... 328-329, 336

Shredders..... 243

**First Aid**

Bleeding Control..... 281

Emergency Preparedness..... 280-282

First Aid Kits ..... 280-282

Rescue Systems..... 282

**L**

Lecterns..... 145-146

**Lockers**

Early Childhood..... 316-318

Padlocks..... 278

Storage Unit ..... 266

**M**

**Markerboard**

Easels ..... 160, 162

Glass ..... 147-148, 158

Lap Boards..... 154

Magnetic ..... 147-152, 154, 158-160

Message Boards..... 163-164

Resurfacing..... 156-157

Reversible Boards..... 158-162

**Makerspace**

3D Printers & Stands ..... 109, 112-114

Markerboards..... 160

STEM & STEAM..... 103, 115-116, 332

Storage ..... 108-109

Tables..... 103-105

Utility Carts..... 374

Workbenches..... 106

**Mats**

Chair ..... 236-237

Floor..... 271

Rest ..... 356-357

Metal Detectors..... 275

**Music Room**

Dollies ..... 93

Music Stands..... 93

Seating..... 92-93

Stages & Risers..... 94-95

**O**

**Office**

Bookcases ..... 216, 238-239, 246-248

Chair Mats ..... 236-237

Filing Cabinets..... 211, 216, 240-242

Guest Chairs..... 222, 233

Office Suites ..... 214-218

Organizer & Mailroom Organizers ..... 244-245

Panels..... 219

Reception Seating ..... 221

Sit and Stand ..... 182, 212

Task Chairs..... 223-235



- Teacher Desk ..... 210-211
- Outdoor & Playground**
- Basketball ..... 291-293
- Benches ..... 286-288
- Bike Racks ..... 289
- Bleachers ..... 290
- Early Childhood ..... 301
- Playground Equipment ..... 293-300
- Picnic Tables, Benches & Receptacles ..... 286
- Recycled Picnic Tables & Benches ..... 288
- P**
- Pallet Jack ..... 269
- Paper Shredders ..... 243
- Playground Packages ..... 294
- Playground Structures ..... 294-298, 300
- Portable Chairs and Tables**
- Caddies & Dollies ..... 201, 204, 206, 208-209
- Folding Chairs ..... 201, 204-207
- Folding Tables ..... 201-203
- Stack Chairs ..... 208-209
- Portable Sinks ..... 200, 344
- Presentation**
- Combination Boards ..... 148, 151
- Display Rails ..... 155
- Easels ..... 160, 162
- Enclosed Message Boards ..... 164
- Glass Markerboards ..... 147-148, 158-159
- Lap Boards ..... 154, 160
- Markerboard Resurfacing ..... 156-157
- Markerboards ..... 147-152, 158
- Message Displays & Signs ..... 163
- Porcelain Steel Boards ..... 149-151
- Projection Boards ..... 149
- Reversible Boards ..... 158-161
- Tackboards ..... 151-153
- Trophy & Display Cases ..... 165
- R**
- Racks**
- Bike ..... 289
- Ceramic Ware ..... 87
- Drying ..... 91
- Ride-Ons ..... 301, 372
- Room Dividers ..... 267-268, 312, 345
- S**
- Safety & Security**
- Air Purification ..... 273
- Bleeding Control ..... 281
- Door Locks ..... 276-277
- Emergency Kits ..... 280
- Halo ..... 272
- Padlocks ..... 278
- Recovery Room ..... 279
- Rescue Systems ..... 282
- Two Way Radios ..... 274
- Visitor Management ..... 275
- Window Shades ..... 275
- Sanitizers**
- Cleaners ..... 284
- Hand ..... 283
- Spray ..... 284
- Wipes ..... 284
- Science**
- Augmented Reality Sandbox ..... 100
- Stools ..... 101
- Storage ..... 102
- Tables ..... 96-100
- Wood Cabinets ..... 102
- Workstations ..... 98-99
- Sit and Stand**
- Adjustable Tables ..... 62, 64-65, 68-69, 82, 103, 195
- Desk Risers ..... 212
- Desks ..... 53-59, 213
- Soft Seating**
- Classroom ..... 12, 354-355
- Commons Area and Media Center ..... 166-175
- Special Needs**
- Active Seating ..... 313, 354
- Fine Motor ..... 310
- Multi-Sensory ..... 302-311
- Step Stools ..... 269
- Storage**
- Art ..... 84, 88-89, 343
- Bags ..... 338
- Baskets and Bins ..... 322-323
- Bench ..... 325, 371
- Blocks ..... 327
- Bookcases ..... 216, 238-239, 328-329, 336
- Cabinets ..... 84, 88, 102, 108-109, 246-252, 279, 324, 330-331
- Carts ..... 88, 257, 318, 338-339, 343, 355-356, 374
- Cubbies ..... 316-322, 330
- Early Childhood ..... 316-342
- Lockers ..... 266, 316-318, 330
- Mobile ..... 88, 108-109, 112, 170, 246-252, 261-262, 317-322, 324-322, 335-337
- Organizers ..... 330, 332-342
- Shelving ..... 264-265, 328, 336
- Trays & Totes ..... 45, 48-49, 56, 70, 322-323
- Units ..... 319-322, 326-330, 335-336
- T**
- Tables**
- Accessories ..... 62, 64-76, 78-79, 105, 349
- Activity ..... 62-73, 103, 203, 351-352
- Art ..... 83
- Cafeteria ..... 185-199
- Block ..... 375
- Children's ..... 286, 348, 353, 375
- Computer ..... 78-79, 82
- Folding ..... 201-203
- Light ..... 374
- Makerspace ..... 103-105
- Picnic ..... 285, 288
- Recycled ..... 288
- Sand and Water ..... 100, 371, 373
- Science ..... 96-100
- STEM and STEAM ..... 103, 115-116, 332
- Utility ..... 76-79, 104-105
- Wood ..... 288, 347-348
- Trash Receptacles ..... 200, 286-287
- Tricycles ..... 301, 372
- Trophy Cases ..... 165
- TV Mounts ..... 120
- U**
- Utility Carts ..... 200, 269
- V**
- Visitor Management**
- Metal Detectors ..... 275
- W**
- Wagons ..... 301
- Wheelchairs ..... 279
- Window Shades ..... 275
- Workbenches ..... 106

# easy, efficient ordering

another example of best total value™ at work

## DELIVERY OPTIONS

Most orders ship within four to six weeks. Please allow an additional two weeks in the summer due to back-to-school volume.

You can specify a delivery date, including the earliest and latest date for your order delivery.

## SHIPPING & HANDLING CHARGES

Shipping and handling is to be applied individually to parcel and truck/freight portions of the orders. Mixed orders must be subtotaled individually and appropriate shipping and handling charges are to be applied. For example, if an order totaling \$150 is placed and \$75 is parcel (items with a prefix of 5 or 9), then shipping and handling will apply for the parcel portion according to the policy for the item prefix number. The truck/freight shipping and handling charges will apply to the balance.

## THE FIRST NUMBER IN YOUR ITEM CODE TELLS HOW YOUR PRODUCT SHIPS

Simply look at the item number to determine the method of shipment. Use the graphic that is located at the bottom of each right page to help you determine how your products will ship. Items beginning with 5 or 9 ship via parcel and items beginning with 6 ship via freight.

Please be sure to include color, size, fabric, and frame finish to avoid delays on furniture and equipment orders!

## EASY TERMS FOR NEW ACCOUNTS

Send a full credit application (located next to the order form) and a check to expedite your first order. For individual orders, we accept Visa, MasterCard, American Express, Discover, or checks (no cash, please).

Sales tax – Please include sales tax for all sales using credit cards or personal checks.

Payment terms – All items shipped and billed are due for payment within 30 days of our invoice date.

## CURRENT PRICE & PRODUCT INFORMATION

Although we intend to maintain prices during the life of this catalog, we reserve the right to revise prices, limit quantities and correct printing/pricing errors at our sole discretion. If a product is displayed or described inaccurately, we will attempt to notify you before processing your order.

## RETURN POLICY

When returning merchandise, it is necessary to contact School Specialty to obtain a return authorization. Furniture returns must be requested within 30 days of order receipt, and freight damages must be reported within 48 hours of order receipt. Please visit [Select.SchoolSpecialty.com](http://Select.SchoolSpecialty.com) and review the complete return policy in order to make this process go as smoothly and quickly as possible.

## IMPORTANT TIPS FOR RECEIVING YOUR ORDER

1. Count your cartons and only sign for those received. If you experience a shortage, note it on your packing slip and call our Customer Care Advocates.
2. Immediately inspect for external and internal/concealed damage. If you notice damage, keep merchandise and shipping cartons and notify Customer Care within 7 days of receipt of your shipment. (Carriers will not honor claims if it has been more than 7 days since your shipment has been received.)
3. Locate and review your packing list.
4. Open "mixed" cartons, being careful to prevent discarding smaller items or hardware along with packing materials.
5. Record any errors on the packing list and call Customer Care at 1-888-388-3224 with discrepancies.

## The first number in your product code indicates how your product ships

Simply look at the item number to determine the method of shipment. Use the graphic below that is located at the bottom of each right page to help you determine how your products will ship.

SHIPPING & HANDLING		
Item Prefix	Shipment Type	Charge
5	Parcel or Truck	\$9.95 minimum or 15%
9	Parcel	\$9.95 minimum or Free for orders over \$49*
6	Truck/Freight	\$99 minimum or 15%*

We reserve the right to determine the method used to fulfill your order and special orders may incur additional shipping and handling fees. Special orders include, but are not limited to "hazardous material" deliveries and additional charges may apply. Inside delivery and lift gate delivery are now FREE. Delivery fees are subject to change without notice.

\*Some exclusions may apply. For our detailed shipping and handling policy, see page 383.



# SHIPPING & HANDLING • PRICE & PRODUCT INFO WARRANTIES • RETURN POLICY

## SHIPPING & HANDLING

### ITEMS SHIPPED WITHIN THE CONTIGUOUS 48 UNITED STATES

#### Items with a 9 prefix ship Parcel

- Free shipping and handling on orders of \$49 or more. Free shipping calculation is based on the subtotals of items with 9 prefixes, after any additional discounts are applied. For subtotals less than \$49, the shipping and handling charge is \$9.95.

#### Items with a 5 prefix ship Parcel or Truck

- Shipping and handling charges are 15% of the subtotal of the items with 5 prefixes, after any discounts are applied, with a \$9.95 minimum charge.

#### Items with a 6 prefix ship Truck/Freight

- Shipping and handling charges are 15% of the subtotals of the items with 6 prefixes, after any discounts are applied, with a \$99 minimum charge. If the subtotal is greater than \$1,000, please call 1-877-350-0645 or email [freight\\_quote@schoolspecialty.com](mailto:freight_quote@schoolspecialty.com) for a freight quote.

Now **FREE** inside delivery.

Now **FREE** lift gate delivery.

### QUICKSHIP LEAD TIME

Furniture items with a QUICKSHIP icon in front of the item number will ship as specified.



**Important:** Orders that contain both quickship and non-quickship items will default to the standard lead time.

### ITEMS SHIPPED TO ALASKA & HAWAII

Important changes to our Alaska and Hawaii shipping policy are now in effect. Please visit [Select.SchoolSpecialty.com/er-shipping-policy](http://Select.SchoolSpecialty.com/er-shipping-policy) for detailed information.

### SPECIAL DELIVERY REQUESTS

Call Customer Care for quote:  
1-888-388-3224.

### ADDITIONAL NOTES ON ITEM LEGENDS

Some items are noted with alpha codes and have the following shipping and handling requirements:

#### Item Number Legend:

N — Non-Discountable

H — Hazardous: Contains hazardous material, will incur an additional charge

L — Live Material Coupon; pre-paid coupon that must be redeemed to receive materials, additional charges apply.

#### Additional Shipping Charges for Hazardous Materials (ships via truck):

1-3 Items	\$25.00
4 or more items	\$75.00

#### Additional Shipping Charges for Live items:

1-3 Items	\$12.50
4-5 items	\$22.00
6+ items	\$30.00

### ITEMS SHIPPED INTERNATIONALLY & TO U.S. TERRITORIES

- Call Customer Care for quote:  
1-419-589-1425.
- Delivery times and methods vary based on location and order.

### ADO/FPO/DPO

- Shipping and handling rates follow contiguous 48 shipping policies.
- Orders are shipped using U.S. Postal Service via Standard Post.
- Individual items that exceed shipping size restrictions for the U.S. Postal Service will require an alternate physical shipping address and may be subject to additional fees.
- Contact International Customer Care at 1-419-589-1425 for further information.

### Additional information regarding shipping, handling and surcharges

Delivery fees and terms are subject to change without notice. For current information about shipping and handling, please visit [Select.SchoolSpecialty.com/er-shipping-policy](http://Select.SchoolSpecialty.com/er-shipping-policy) or call Customer Care at 1-888-388-3224. We reserve the right to determine the method used to fulfill your order and special orders may incur additional shipping and handling fees. We also reserve the right to impose a fuel surcharge as conditions warrant. Standard delivery terms shall be F.O.B. origin. Ownership and title shall pass to Buyer when products are delivered to Carrier unless otherwise agreed to in writing.

## CURRENT PRICE & PRODUCT INFO

Although we intend to maintain prices during the life of this catalog and on our website, we reserve the right to revise prices, limit quantities and correct printing/pricing errors at our sole discretion. If a product is displayed or described inaccurately, we will attempt to notify you before processing your order.

## WARRANTIES

Find product warranty information before you purchase by visiting [Select.SchoolSpecialty.com/warranties](http://Select.SchoolSpecialty.com/warranties).

## RETURN POLICY

Please visit [Select.SchoolSpecialty.com/returns](http://Select.SchoolSpecialty.com/returns) for information about School Specialty's return policy.



# We'll help you invest your funding where it matters most.

**Together, we can turn your funding into solutions.**

We know when it comes to funding, it's not about spending money. It's about investing in student success. To help you make the most of it, we offer 100,000+ products in 15 categories plus expert guidance to help find the best solutions.

Ready to get started?

Visit [Select.SchoolSpecialty.com/funding](https://www.Select.SchoolSpecialty.com/funding)

Snap to learn more.



# 15 categories. 100,000+ products. One choice.

We participate in many national, regional, and local purchasing cooperatives and hold numerous state contracts.

With our unrivaled breadth and depth of education products, you can enjoy the ease of one PO and the peace of mind knowing you're getting legally compliant, competitively bid prices across every category:

- Furniture
- Arts & Crafts
- Classroom & Office Supplies
- Science
- Early Childhood
- And much more



Learn more about your state's contracts at  
[Select.SchoolSpecialty.com/purchasing-cooperatives](https://Select.SchoolSpecialty.com/purchasing-cooperatives)



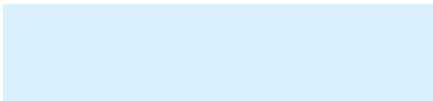

LE23



/SchoolSpecialty



@SchoolSpecialty



/SchoolSpecialty



@SchoolSpecialty

# SHOP ONLINE.

More products.  
More savings.  
More control.

Our enhanced ecommerce experience is built to save you serious money and precious time.

- **See your discounted pricing automatically** whenever you sign in.
- **Control budgets with approval workflows.** No order gets placed without your approval.
- **Manage and track orders like never before.** Access invoices, check order status, and see order history.
- **Avoid mismatched POs.** Online orders are more accurate – items, pricing, and shipping charges are accurate online.
- **Make purchasing more seamless.** Our website integrates with most procurement systems: Skyward, Infinite Visions, Munis, PowerSchool, Peoplesoft, and more.



**GO TO [Select.SchoolSpecialty.com](https://Select.SchoolSpecialty.com) NOW**