

SCREENS

March 2023 Price List

AIS

SCREENS PRODUCT INFORMATION AND FINISH OPTIONS

SCREENS PRODUCT INFORMATION

Screen Types 7

Screen Materials 8

Screen Mount Types 9

Where Used Information 10

Sized For Information 13

Handedness and Cut-Out Information 14

Screen Model Number Logic 17

SCREEN FINISH OPTIONS

Tackable Fabric Options 18

Paint Options 19

Laminate Options 20

SCREENS SIZED FOR NOMINAL = ACTUAL SIZE

CHANNEL SCREENS FOR NOMINAL = ACTUAL SIZES

Lexan Nominal = Actual Size Territory Surface Mount Channel Screens 22

Glass Nominal = Actual Size Territory Surface Mount Channel Screens 23

PET Nominal = Actual Size Territory Surface Mount Channel Screens 25

Lexan Nominal = Actual Size Territory Under Surface Mount Channel Screens 26

Glass Nominal = Actual Size Territory Under Surface Mount Channel Screens 27

PET Nominal = Actual Size Territory Under Surface Mount Channel Screens 29

Lexan Nominal = Actual Size Front/Rear Surface Mount Channel Screens 30

Glass Nominal = Actual Size Front/Rear Surface Mount Channel Screens 31

PET Nominal = Actual Size Front/Rear Surface Mount Channel Screens 33

Lexan Nominal = Actual Size Front/Rear Under Surface Mount Channel Screens 34

Glass Nominal = Actual Size Front/Rear Under Surface Mount Channel Screens 35

PET Nominal = Actual Size Front/Rear Under Surface Mount Channel Screens 37

Lexan Nominal = Actual Size Panel Top Surface Mount Channel Screens 39

Glass Nominal = Actual Size Panel Top Surface Mount Channel Screens 40

PET Nominal = Actual Size Panel Top Surface Mount Channel Screens 44

Lexan Gallery Panel Side Mount Channel Screens 46

PET Gallery Panel Side Mount Channel Screens 47

CLIP SCREENS FOR NOMINAL = ACTUAL SIZES

Lexan Nominal = Actual Size Territory Surface Mount Clip Screens 48

Glass Nominal = Actual Size Territory Surface Mount Clip Screens 49

Lexan Nominal = Actual Size Territory Under Surface Mount Clip Screens 51

Glass Nominal = Actual Size Territory Under Surface Mount Clip Screens 53

Lexan Nominal = Actual Size Territory Freestanding Clip Screens 55

Lexan Nominal = Actual Size Front/Rear Surface Mount Clip Screens 56

Glass Nominal = Actual Size Front/Rear Surface Mount Clip Screens 58

Lexan Nominal = Actual Size Front/Rear Under Surface Mount Clip Screens 60

Glass Nominal = Actual Size Front/Rear Under Surface Mount Clip Screens 62

Lexan Nominal = Actual Size Freestanding Clip Screens 64

Lexan Nominal = Actual Size Panel Top Surface Mount Clip Screens 66

Glass Nominal = Actual Size Panel Top Surface Mount Clip Screens 67

Glass Nominal = Actual Size Modesty Mount Clip Screens 71

LITE SCREENS FOR NOMINAL = ACTUAL SIZES

PET Nominal = Actual Size Territory Surface Mount Lite Screens 73

PET Nominal = Actual Size Territory Under Surface Mount Lite Screens. 74

PET Nominal = Actual Size Territory Freestanding Lite Screens 75

PET Nominal = Actual Size Front/Rear Surface Mount Lite Screens 76

PET Nominal = Actual Size Front/Rear Under Surface Mount Lite Screens 78

PET Nominal = Actual Size Front/Rear Freestanding Mount Lite Screens 80

PET Nominal = Actual Size Panel Top Surface Mount Lite Screens 82

SLIMLINE SCREENS FOR NOMINAL = ACTUAL SIZES

Nominal = Actual Size Territory Surface Mount Slimline Screens 84

Nominal = Actual Size Territory Under Surface Mount Slimline Screens 85

Nominal = Actual Size Front/Rear Surface Mount Slimline Screens 86

Nominal = Actual Size Front/Rear Under Surface Mount Slimline Screens 87

Nominal = Actual Size Front/Rear Freestanding Slimline Screens 88

SCREENS SIZED FOR DIVI PANEL DIMENSIONS

CHANNEL SCREENS FOR DIVI PANEL DIMENSIONS

Lexan Divi Panel Top Surface Mount Channel Screens 90

Glass Divi Panel Top Surface Mount Channel Screens 91

PET Divi Panel Top Surface Mount Channel Screens. 95

Lexan Divi Gallery Panel Side Mount Channel Screens 97

PET Divi Gallery Panel Side Mount Channel Screens 98

CLIP SCREENS FOR DIVI PANEL DIMENSIONS

Lexan Divi Panel Top Surface Mount Clip Screens 99

Glass Divi Panel Top Surface Mount Clip Screens 100

LITE SCREENS FOR DIVI PANEL DIMENSIONS

PET Divi Panel Top Surface Mount Lite Screens 104

SCREENS SIZED FOR DAY-TO-DAY & CALIBRATE HAT DEPTHS

CHANNEL SCREENS FOR DAY-TO-DAY & CALIBRATE HAT DEPTHS

Lexan Day-to-Day & Calibrate HAT Depth Territory Surface Mount Channel Screens 107

Glass Day-to-Day & Calibrate HAT Depth Territory Surface Mount Channel Screens 108

PET Day-to-Day & Calibrate HAT Depth Territory Surface Mount Channel Screens 110

Lexan Day-to-Day & Calibrate HAT Depth Territory Under Surface Mount Channel Screens 111

Glass Day-to-Day & Calibrate HAT Depth Territory Under Surface Mount Channel Screens 112

PET Day-to-Day & Calibrate HAT Depth Territory Under Surface Mount Channel Screens 114

CLIP SCREENS FOR DAY-TO-DAY & CALIBRATE HAT DEPTHS

Lexan Day-to-Day & Calibrate HAT Depth Territory Surface Mount Clip Screens 115

Glass Day-to-Day & Calibrate HAT Depth Territory Surface Mount Clip Screens 116

Lexan Day-to-Day & Calibrate HAT Depth Territory Under Surface Mount Clip Screens. 118

Glass Day-to-Day & Calibrate HAT Depth Territory Under Surface Mount Clip Screens. 120

Lexan Day-to-Day & Calibrate HAT Depth Territory Freestanding Clip Screens 122

SLIMLINE SCREENS FOR DAY-TO-DAY & CALIBRATE HAT DEPTHS

Day-to-Day & Calibrate HAT Depth Territory Surface Mount Slimline Screens. 123

Day-to-Day & Calibrate HAT Depth Territory Under Surface Mount Slimline Screens 124

SCREENS SIZED FOR ALOFT & BENCHING HAT DEPTHS

CHANNEL SCREENS FOR ALOFT & BENCHING HAT DEPTHS

Lexan Aloft & Benching HAT Depth Territory Surface Mount Channel Screens 126
 Glass Aloft & Benching HAT Depth Territory Surface Mount Channel Screens. 127
 PET Aloft & Benching HAT Depth Territory Surface Mount Channel Screens 129
 Lexan Aloft & Benching HAT Depth Territory Under Surface Mount Channel Screens. 130
 Glass Aloft & Benching HAT Depth Territory Under Surface Mount Channel Screens 131
 PET Aloft & Benching HAT Depth Territory Under Surface Mount Channel Screens. 133

CLIP SCREENS FOR ALOFT & BENCHING HAT DEPTHS

Lexan Aloft & Benching HAT Depth Territory Surface Mount Clip Screens. 134
 Glass Aloft & Benching HAT Depth Territory Surface Mount Clip Screens 135
 Lexan Aloft & Benching HAT Depth Territory Under Surface Mount Clip Screens 137
 Glass Aloft & Benching HAT Depth Territory Under Surface Mount Clip Screens 139
 Lexan Aloft & Benching HAT Depth Territory Freestanding Clip Screens. 141

LITE SCREENS FOR ALOFT & BENCHING HAT DEPTHS

PET Aloft & Benching HAT Depth Territory Surface Mount Lite Screens 142
 PET Aloft & Benching HAT Depth Territory Surface Under Mount Lite Screens 143
 PET Aloft & Benching HAT Depth Territory Freestanding Lite Screens 145

SLIMLINE SCREENS FOR ALOFT & BENCHING HAT DEPTHS

Aloft & Benching HAT Depth Territory Surface Mount Slimline Screens 146
 Aloft & Benching HAT Depth Territory Under Surface Mount Slimline Screens. 147

SCREENS SIZED FOR OXYGEN WORKSURFACE DEPTHS

CHANNEL SCREENS FOR OXYGEN WORKSURFACE DEPTHS

Lexan Oxygen Worksurface Depth Territory Surface Mount Channel Screens. 149
 Glass Oxygen Worksurface Depth Territory Surface Mount Channel Screens 150
 PET Oxygen Worksurface Depth Territory Surface Mount Channel Screens. 152
 Lexan Oxygen Worksurface Depth Territory Under Surface Mount Channel Screens 153
 Glass Oxygen Worksurface Depth Territory Under Surface Mount Channel Screens 154
 PET Oxygen Worksurface Depth Territory Under Surface Mount Channel Screens 156

CLIP SCREENS FOR OXYGEN WORKSURFACE DEPTHS

Lexan Oxygen Worksurface Depth Territory Surface Mount Clip Screens 157
 Glass Oxygen Worksurface Depth Territory Surface Mount Clip Screens 158
 Lexan Oxygen Worksurface Depth Territory Under Surface Mount Clip Screens 160
 Glass Oxygen Worksurface Depth Territory Under Surface Mount Clip Screens. 161
 Lexan Oxygen Worksurface Depth Territory Freestanding Clip Screens 163

LITE SCREENS FOR OXYGEN WORKSURFACE DEPTHS

PET Oxygen Worksurface Depth Territory Surface Mount Lite Screens 164
 PET Oxygen Worksurface Depth Territory Under Surface Mount Lite Screens. 165
 PET Oxygen Worksurface Depth Territory Freestanding Lite Screens 166

SLIMLINE SCREENS FOR OXYGEN WORKSURFACE DEPTHS

Oxygen Worksurface Depth Territory Surface Mount Slimline Screens 167
 Oxygen Worksurface Depth Territory Under Surface Mount Slimline Screens 168
 Oxygen Worksurface Depth Side Split Slimline Screens 169

SCREENS SIZED FOR DAY-TO-DAY, CALIBRATE & BENCHING HAT WIDTHS

CHANNEL SCREENS FOR DAY-TO-DAY, CALIBRATE & BENCHING HAT WIDTHS

Lexan Day-to-Day, Calibrate & Benching HAT Width Front/Rear Surface Mount Channel Screens 171

Glass Day-to-Day, Calibrate & Benching HAT Width Front/Rear Surface Mount Channel Screens 172

PET Day-to-Day, Calibrate & Benching HAT Width Front/Rear Surface Mount Channel Screens 174

Lexan Day-to-Day, Calibrate & Benching HAT Width Front/Rear Under Surface Mount Channel Screens 176

Glass Day-to-Day, Calibrate & Benching HAT Width Front/Rear Under Surface Mount Channel Screens. 177

PET Day-to-Day, Calibrate & Benching HAT Width Front/Rear Under Surface Mount Channel Screens 179

CLIP SCREENS FOR DAY-TO-DAY, CALIBRATE & BENCHING HAT WIDTHS

Lexan Day-to-Day, Calibrate & Benching HAT Width Front/Rear Surface Mount Clip Screens 181

Glass Day-to-Day, Calibrate & Benching HAT Width Front/Rear Surface Mount Clip Screens 183

Lexan Day-to-Day, Calibrate & Benching HAT Width Front/Rear Under Surface Mount Clip Screens. 185

Glass Day-to-Day, Calibrate & Benching HAT Width Front/Rear Under Surface Mount Clip Screens 187

Lexan Day-to-Day, Calibrate & Benching HAT Width Front/Rear Freestanding Clip Screens 189

LITE SCREENS FOR DAY-TO-DAY, CALIBRATE & BENCHING HAT WIDTHS

PET Day-to-Day, Calibrate & Benching HAT Width Front/Rear Surface Mount Lite Screens 191

PET Day-to-Day, Calibrate & Benching HAT Width Front/Rear Under Surface Mount Lite Screens 193

PET Day-to-Day, Calibrate & Benching HAT Width Front/Rear Freestanding Lite Screens 195

SLIMLINE SCREENS FOR DAY-TO-DAY, CALIBRATE & BENCHING HAT WIDTHS

Day-to-Day, Calibrate & Benching HAT Width Front/Rear Surface Mount Slimline Screens 197

Day-to-Day, Calibrate & Benching HAT Width Front/Rear Under Surface Mount Slimline Screens 198

Day-to-Day, Calibrate & Benching HAT Width Front/Rear Freestanding Slimline Screens 199

SCREENS SIZED FOR ALOFT WORKSURFACE WIDTHS

CHANNEL SCREENS FOR ALOFT WORKSURFACE WIDTHS

Lexan Aloft Worksurface Width Front/Rear Surface Mount Channel Screens 201

Glass Aloft Worksurface Width Front/Rear Surface Mount Channel Screens 202

Glass Aloft 120 HAT Width Front/Rear Surface Mount Channel Screens 204

PET Aloft Worksurface Width Front/Rear Surface Mount Channel Screens 205

Lexan Aloft Worksurface Width Front/Rear Under Surface Mount Channel Screens 207

Glass Aloft Worksurface Width Front/Rear Under Surface Mount Channel Screens. 208

PET Aloft Worksurface Width Front/Rear Under Surface Mount Channel Screens 210

CLIP SCREENS FOR ALOFT WORKSURFACE WIDTHS

Lexan Aloft Worksurface Width Front/Rear Surface Mount Clip Screens 212

Glass Aloft Worksurface Width Front/Rear Surface Mount Clip Screens. 214

Lexan Aloft Worksurface Width Front/Rear Under Surface Mount Clip Screens. 216

Glass Aloft Worksurface Width Front/Rear Under Surface Mount Clip Screens 218

Lexan Aloft Worksurface Width Front/Rear Freestanding Clip Screens 220

LITE SCREENS FOR ALOFT WORKSURFACE WIDTHS

PET Aloft Worksurface Width Front/Rear Surface Mount Lite Screens. 222

PET Aloft Worksurface Width Front/Rear Under Surface Mount Lite Screens 224

PET Aloft Worksurface Width Front/Rear Freestanding Lite Screens 226

SLIMLINE SCREENS FOR ALOFT WORKSURFACE WIDTHS

Aloft Worksurface Width Front/Rear Surface Mount Slimline Screens 228

Aloft 120 HAT Width Front/Rear Surface Mount Slimline Screens 229

Aloft Worksurface Width Front/Rear Under Surface Mount Slimline Screens 230

Aloft Worksurface Width Front/Rear Freestanding Slimline Screens 231

Aloft Worksurface Width Universal Spine Mount Slimline Screens 232

L-WRAP SCREENS SIZED FOR DAY-TO-DAY, CALIBRATE & E-SERIES HAT

L-WRAP LITE SCREENS FOR DAY-TO-DAY, CALIBRATE & E-SERIES HAT

PET Day-to-Day, Calibrate & E-Series HAT L-Wrap Under Surface Mount Lite Screens 234
 PET Day-to-Day, Calibrate & E-Series HAT L-Wrap Partial Modesty Under Surface Mount Lite Screens 252

L-WRAP SCREENS SIZED FOR NOMINAL = ACTUAL SIZE

L-WRAP LITE SCREENS FOR NOMINAL = ACTUAL SIZE

PET Nominal = Actual Size L-Wrap Under Surface Mount Lite Screens 271
 PET Nominal = Actual Size L-Wrap Partial Modesty Under Surface Mount Lite Screens 289

U-WRAP SCREENS SIZED FOR DAY-TO-DAY, CALIBRATE & E-SERIES HAT

U-WRAP LITE SCREENS FOR DAY-TO-DAY, CALIBRATE & E-SERIES HAT

PET Day-to-Day, Calibrate & E-Series HAT U-Wrap Under Surface Mount Lite Screens 308
 PET Day-to-Day, Calibrate & E-Series HAT U-Wrap Partial Modesty Under Surface Mount Lite Screens 317

U-WRAP SCREENS SIZED FOR NOMINAL = ACTUAL SIZE

U-WRAP LITE SCREENS FOR NOMINAL = ACTUAL SIZE

PET Nominal = Actual Size U-Wrap Under Surface Mount Lite Screens 327
 PET Nominal = Actual Size U-Wrap Partial Modesty Under Surface Mount Lite Screens 336

L-WRAP ENCLOSURES WITH WIRE MANAGERS

PET L-WRAP ENCLOSURES WITH WIRE MANAGERS

PET Nominal = Actual Size L-Wrap Enclosures with Wire Managers 345
 PET Day-to-Day, Calibrate & E-Series HAT L-Wrap Enclosures with Wire Managers 357
 PET Benching HAT L-Wrap Enclosures with Wire Managers 369

U-WRAP ENCLOSURES WITH WIRE MANAGERS

U-WRAP ENCLOSURES WITH WIRE MANAGERS

PET Nominal = Actual Size U-Wrap Enclosures with Wire Managers 382
 PET Day-to-Day & Calibrate HAT U-Wrap Enclosures with Wire Managers 388
 PET Benching HAT U-Wrap Enclosures with Wire Managers 394

SCREENS WITH WIRE MANAGERS

PET SCREENS WITH WIRE MANAGERS

PET Nominal = Actual Size Screens with Wire Managers 401
 PET Day-to-Day, Calibrate & Benching HAT Screens with Wire Managers 402

CARE AND MAINTENANCE

Please see online care and maintenance guide online: [Care and Maintenance Procedures](#)

WARRANTY & TERMS AND CONDITIONS

For Warranty & Terms and Conditions please visit: [Warranty & Terms and Conditions](#)

Screen Types

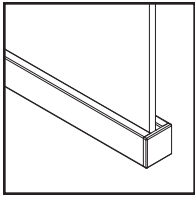

Channel Screens

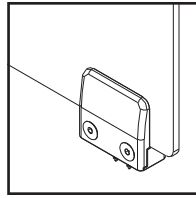

Clip Screens

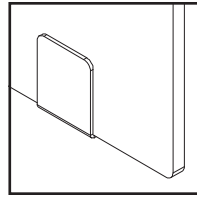

Lite Clip PET Screens

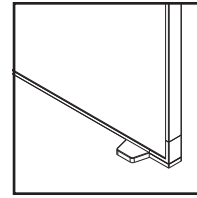

Slimline Framed Screens

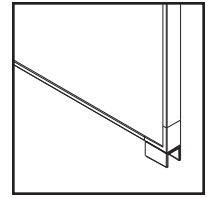

Universal Spine
Insert Screens

Channel Screens

- The Channel style screen has a painted aluminum channel which holds a frameless piece of 1/4" thick or 3/8" thick Glass, 1/4" thick Lexan or a 1/2" thick piece of PET.
- The materials are held by set screws on one side which are then covered by a cover extrusion and endcaps.
- Channel screens can be mounted directly to a worksurface, panel, storage element or gallery panel or attached to a number of different brackets or feet depending on mount type chosen.
- Channel screens can be applied horizontally or vertically, attached to Gallery Panels.
- Channel dimensions: 1" H and 1" D.

Clip Screens

- The Clip style screen is a frameless piece of 1/4" thick or 3/8" thick Glass or 1/4" thick Lexan held by a matte silver aluminum diecast clamp assembly which is attached either directly to a worksurface, panel, storage element or gallery panel or attached to a number of different brackets or feet depending on Mount Type chosen.
- Clip dimensions: 2 1/8" H , 2 1/3" W and 1 1/2" D.
- Screens mounted to surfaces will receive 2 clips for surfaces 24" – 54" wide, 3 clips for surfaces 60" – 72" wide and 4 clips for surfaces 78" – 84" wide.
- Under Surface Mount Clip and Freestanding Clip can easily convert to surface mount Clip Screens.
- Standard in Metallic Silver.
- Lexan clip screens can have a 2" cut out for wire management or transactions.
- When blending PET Lite Screens and Lexan Clip Screens, please understand that the clips will be different. PET uses Lite Clips. Lexan uses the AIS clip for clear screens.

Lite Clip PET Screens

- The Lite Clip PET screen has painted steel "U" shaped brackets of various sorts that hold 1/2" thick PET for a variety of Mount Types, as well as "L" shaped brackets which attach on one side with screws for Partial Modesty applications.
- Lite Clip PET Screens can be ordered as L-wraps or U-wraps with scored, bendable sections of the screen placed at surface corners.
- Surface Mount Lite clip dimensions: 2 3/8" H x 2" W
- Under Surface Mount Lite clip dimensions: 4" H x 2" W
- Screens mounted to surfaces will receive 2 lite clips for surfaces 24" – 54" wide, 3 lite clips for surfaces 60" – 72" wide and 4 lite clips for surfaces 78" – 84" wide.
- When blending PET Lite Screens and Lexan Clip Screens, please understand that the clips will be different. PET uses Lite Clips. Lexan uses the AIS clip for clear screens.

Slimline Framed Screens

- The slimline framed screen has a painted aluminum frame which holds either fabric, vinyl, whiteboard or laminate inserts on the front and back.
- The bottom corners of the frame have re-inforced threaded holes which allow attachment of various brackets and feet depending on the mount type chosen.
- The fabric version of this screen is tackable, while the whiteboard version can be used with dry erase markers.
- This screen can be specified with different materials front and back.

Universal Spine Insert Screen

- Oxygen, Aloft and Day-to-Day Powerbeam all share the same FIXED HEIGHT top spine element called the Universal Spine.
- The Universal Spine can hold frameless "Inserts" of Glass, Lexan or PET without any other mounting hardware or channels required.
- These insert screens are only for use on Oxygen, Aloft or Powerbeam Spines.

Note: Screens come with all necessary mounting hardware (clips, channel, feet, brackets, etc) at prices shown.

Screen Materials

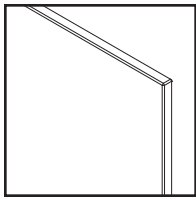

1/4" Clear Glass

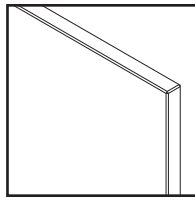

3/8" Clear Glass

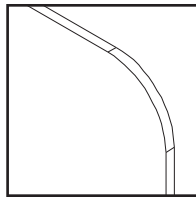

1/4" Clear Lexan

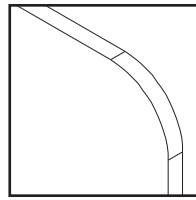

PET

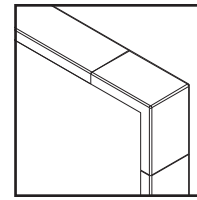

Fabric, Vinyl,
Whiteboard or Laminate

Glass Material

- Tempered glass screens have 90 degree polished corners.
- AIS Glass is standard tempered glass with standard iron content. Request samples from literature center.
- Standard products for glass are always clear unless noted otherwise, other colors may be available upon special request (upcharges apply).
- Glass is easily cleaned with common janitorial supplies.
- 1/4" Glass weighs 2.88 lbs per square foot.
- 3/8" Glass weighs 4.32 lbs per square foot

Lexan Polycarbonate Material

- Lexan screens have 1.5" radius corners and are clear.
- Polycarbonate has specific chemicals that should NOT be used when cleaning (please refer to the AIS Cleaning and Maintenance Guide online).
- 1/4" Lexan weighs 1.44 lbs per square foot.
- Due to the inherent properties of polycarbonate material, slight bowing is possible with Lexan screens.
- AIS cannot ensure the alignment adjacencies of both glass and Lexan materials in clip and channel screens.
- Do not confuse Lexan polycarbonate with Plexi or Plexiglass. There are important differences.
 - Lexan polycarbonate is 200x stronger than plexiglass and is building-code friendly. (Note: local code compliance is the responsibility of the dealer and customer.)
 - Plexi or plexiglass is made of acrylic and does not meet NFPA fire testing requirements. AIS does not use plexiglass on any of our screens.
 - Plexi or plexiglass is very rigid and cracks easier than Lexan polycarbonate.

PET Material

- PET screens have 1.5" radius corners
- PET, stands for polyethylene terephthalate and is a form of polyester. PET Screens are a sustainable material made from plastic bottles and provide a lightweight solution for dividing space.
- PET screens weigh 0.88 lbs per square foot and are 1/2" (12mm) thick.
- Available in four color options: Lite Grey, Medium Grey, Tan and Vibrant Blue.

Fabric, Vinyl, Whiteboard and Laminate Materials

- Tackable fabric, vinyl, whiteboard and laminate are available on Slimline screens.
- Slimline screens may be fabric, vinyl, whiteboard or laminate on either side.
- Upcharges for Grade C and D are listed per side.
- Whiteboards are standard list and have no upcharge.
- Fabric and laminate materials are applied vertically on screens. 66" and 72" wide screens run horizontally.

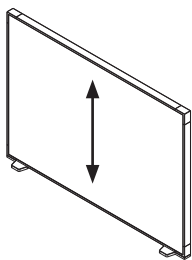

Fabric/laminate applied vertically
(up to 60" wide)

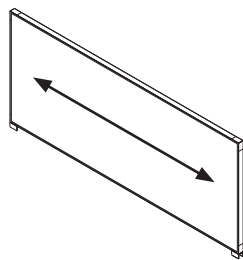

Fabric/laminate applied horizontally
(for 66" and 72" wide)

Screen Mount Types

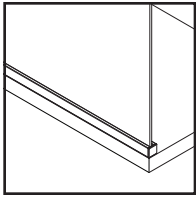

Surface Mount

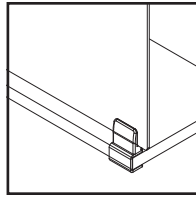

Under Surface Mount

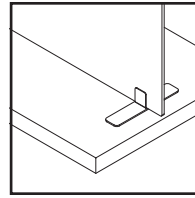

Freestanding Mount

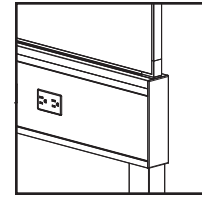

Universal Spine Mount

Surface Mount

- Surface mount screens screw directly into a worksurface, panel or storage element with hardware provided and will leave holes in worksurface, panel or storage element when screen is removed.

Under Surface Mount

- Under surface mount screens are held by brackets that screw into the underside of a worksurface to prevent marring the top of a surface.
- Under surface mount screens fits worksurfaces with thicknesses between 1.0" – 1 3/16".
- As there are often different legs or supports used for worksurfaces, it is important to specify the correct "Where Used" and "Sized For" fields when using under surface mount screens.

Freestanding Mount

- Freestanding screens have 12" deep (6" on each side) low profile painted steel feet with rubber pads.
- Freestanding Clip screen are on non-marring freestanding feet.
- Non-marring freestanding feet dimensions: 2 3/8" x 12".
- Freestanding screens available in clear lexan only.

Universal Spine Mount

- This mount type applies to SLIMLINE SCREENS ONLY, when mounting on top of the Universal Spine used on Aloft, Oxygen and Powerbeam.

Where Used Information

The “Where Used” choice refers to where a screen will be located on a table, worksurface or panel top, and in some cases refers to the type of screen as well.

Territory on Worksurface

The “Territory” choice refers to screens that are used “between” users generally, at their left or right, or shared between them in certain cases, dividing their “territory.” Often Territory Screens correlate to the table’s DEPTH.

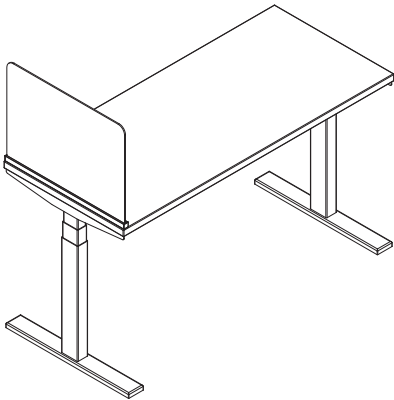
**Front/Rear on Worksurface**

The “Front/Rear” choice is for screens mounted on what is generally the long sides of a table, either the front or the back, and is correlated to the WIDTH. Front/Rear screens can also be freestanding and thus sometimes are placed in the center dividing the long axis of a table.

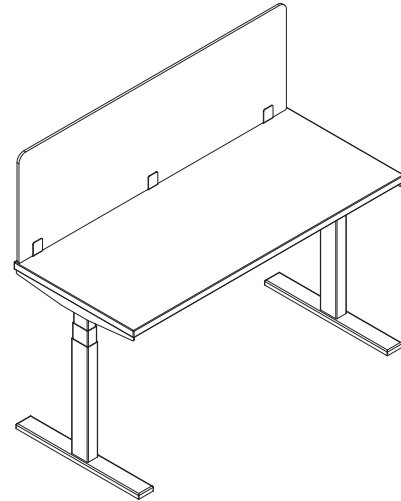
**Partial Modesty on Worksurface**

Partial Modesty on Worksurface corresponds to a rectangular PET or Slimline Screen that mounts such that the screen also hangs below the bottom of the surface form a modesty. These screens mount to one side of a surface.

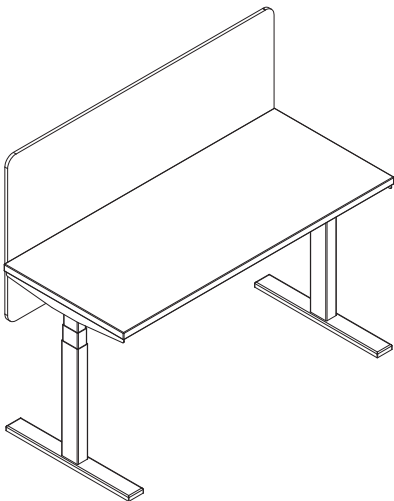
**Panel Top**

Panel top refers to screens that mount on the tops of various panel systems. Usually these screens have specific hardware or dimensions for matching certain panel systems.

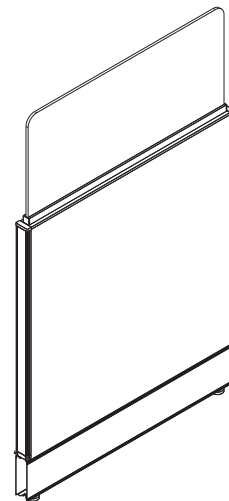

Where Used Information

The “Where Used” choice refers to where a screen will be located on a table, worksurface or panel top, and in some cases refers to the type of screen as well.

Universal Spine

The Universal Spine Choice under Where Used refers to a screen designed to be mounted to the Aloft, Oxygen or Day-to-Day Powerbeam Spine, now known as the Universal Spine.

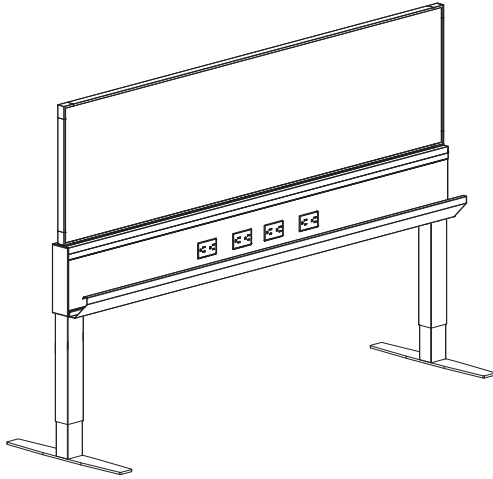

L-Wrap on Worksurface

L-Wrap on Worksurface corresponds to Surface Mounted or Undersurface Mounted PET screens that have a folding section on one side to form a 90 degree angle. These screens have a width component and a depth component.

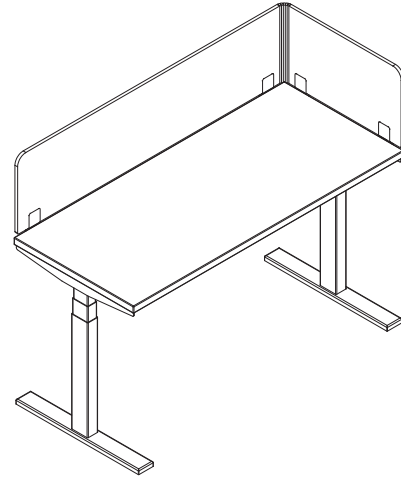

L-Wrap Partial Modesty on Worksurface

L-Wrap Partial Modesty on Worksurface corresponds to PET screens that have a folding section on one side to form a 90 degree angle that also hang below the bottom of the surface to form a modesty. These screens have a width component and a depth component.

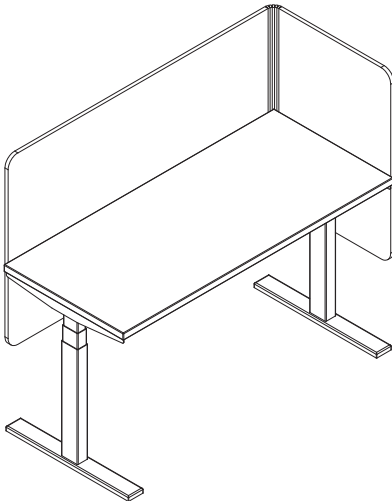

U-Wrap on Worksurface

U-Wrap on Worksurface corresponds to Surface Mounted or Undersurface Mounted PET screens that have a folding section on two sides to form a 90 degree angle on each end. These screens have a width component and a depth component.

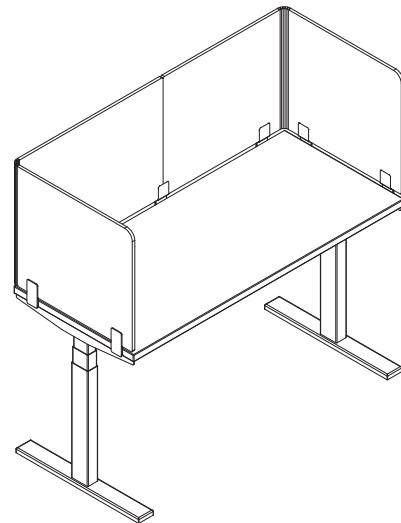

Where Used Information

The “Where Used” choice refers to where a screen will be located on a table, worksurface or panel top, and in some cases refers to the type of screen as well.

U-Wrap Partial Modesty on Worksurface

U-Wrap Partial Modesty on Worksurface corresponds to PET screens that have a folding section on two sides to form a 90 degree angle on both ends that also hang below the bottom of the surface form a modesty. These screens have a width component and a depth component.

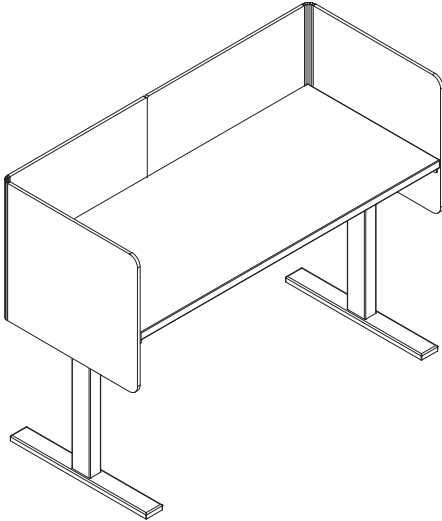
**Gallery Panel Side Mount**

Some Lexan and PET Channel Screens can be used vertically and mounted to the side of a gallery panel, corresponding to its height.

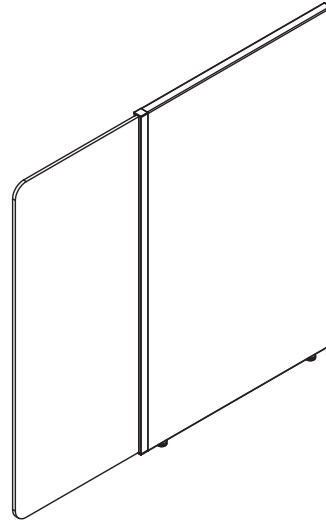

Sized For Information

“Sized For” refers to the specific dimension scenario a screen is being used for. For instance, Height Adjustable Tables have smaller surfaces than fixed height tables for pinch point clearance. A screen mounting on the left or right or rear of a Height Adjustable Table is smaller in actual width than a Fixed Height Table because the HAT table is smaller.

Nominal Size = Actual Size

This parameter choice means different things depending on other parameter choices but generally it means the condition that a screen is being sized for measures very close to what the dimension description calls out. For instance, the dimension calls for 48” wide (the Nominal dimension) and the product the screen is being mounted to or placed on actually measures 48” wide (the actual dimension). Choose this when putting screens on standard AIS workstation worksurfaces or storage elements which meet the Nominal = Actual condition. Heights for worksurface mounted screens will be sized for a scenario where the fixed worksurface height is at AIS standard height of 28 5/8” high and you want the top of the screen to align to a standard AIS product horizon of 42”, 46”, 50”, 58”, 66” (Matrix), 74” or 82” (Matrix). This dimension is nominal dimension + 3/8” i.e. 12” = 12 3/8” high.

Divi Panel Dimensions

Divi panel widths measure 1/8” wider than nominal, and Divi panel heights measure close to nominal height i.e. 66” = 66”. Choose this condition when placing product on Divi panels.

Day-to-Day & Calibrate HAT Depth

Day-to-Day, E-Series and Calibrate Height Adjustable Table depths measure nominal less 1”. Choose this parameter when mounting screens aligning with these tables depths.

Aloft & Benching HAT Depth

The Aloft Bench and Benching Height Adjustable Tables share the same worksurface depth of nominal less 2 1/4”. Choose this parameter when mounting screens aligning with these bench or tables depths.

Oxygen Worksurface Depth

The Oxygen Bench has a worksurface depth of nominal less 1 1/2”. Choose this parameter when mounting screens aligning with Oxygen bench depths.

Day-to-Day, E-Series, Calibrate & Benching HAT Width

Day-to-Day, E-Series, Calibrate & Benching Height Adjustable Tables all share the same width of nominal less 2”. Choose this parameter when mounting screens aligning with these table widths.

Aloft Worksurface Width

Aloft Benching has a worksurface width of nominal less 1”. Choose this parameter when mounting screens aligning with Aloft worksurface width.

L-Wrap for Day-to-Day, E-Series and Calibrate HAT

L-Wrap Screens have a depth as well as a width parameter and require a specific choice for the combination of the two. Day to Day, E-Series and Calibrate Height Adjustable Tables have a depth dimension of nominal less 1” and a width dimension of nominal less 2”. Choose this parameter when mounting L-wrap screens to Day to Day, E-Series and Calibrate Height Adjustable Tables.

L-Wrap for Benching HAT

L-Wrap Screens have a depth as well as a width parameter and require a specific choice for the combination of the two. Benching Height Adjustable Tables have a depth dimension of nominal less 2 1/4” and a width dimension of nominal less 2”. Choose this parameter when mounting L-wrap screens to a Benching Height Adjustable Table.

Handedness and Cut-Out Information

Screen Handedness

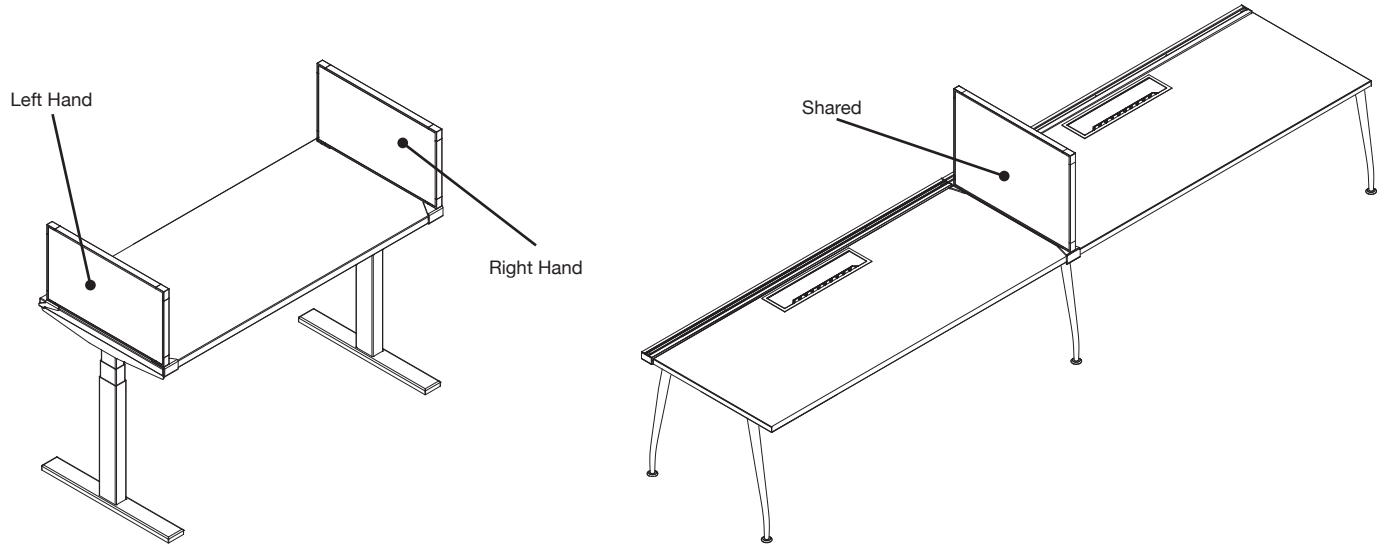

Screen Cut-Outs

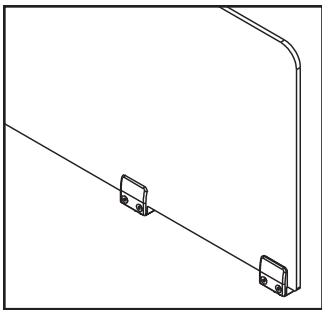

Without Cut-Out

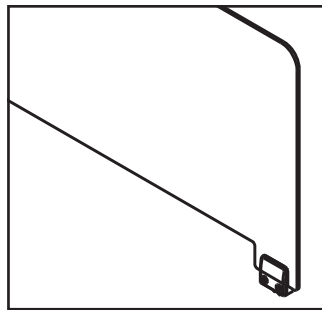

With Cut-Out

PET L-Wrap Enclosures with Wire Managers Details

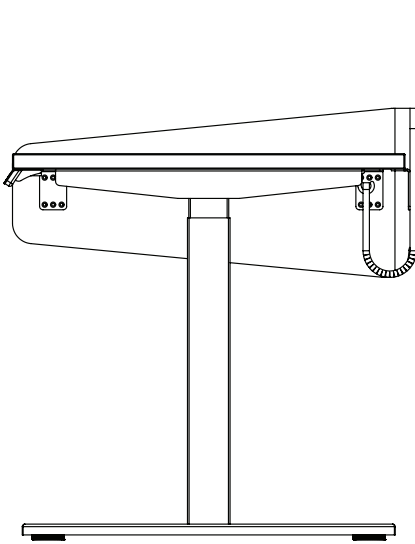

3" surface height shown

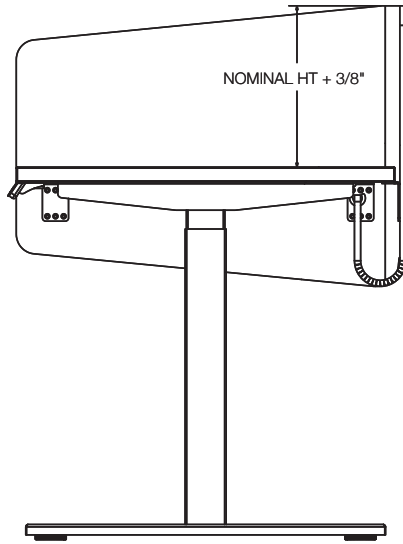

12" and higher surface height shown

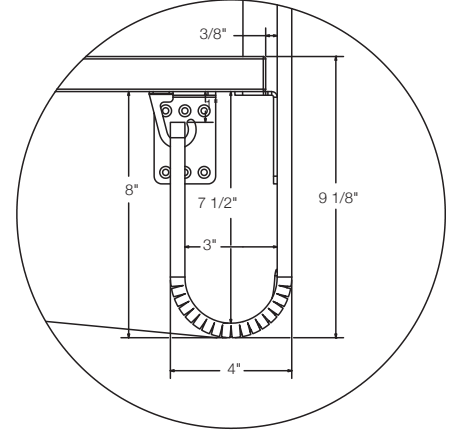

PET U-Wrap Enclosures with Wire Managers Details

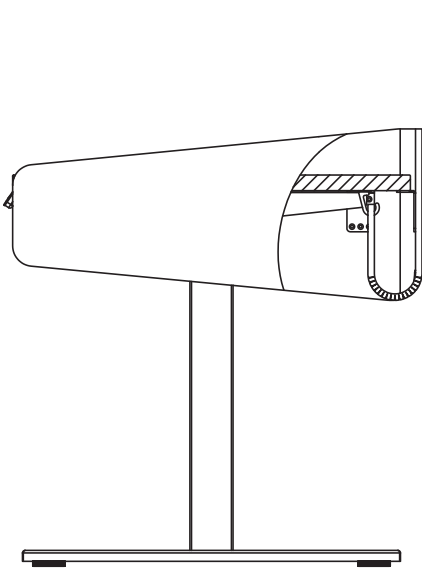

3" and higher surface height shown

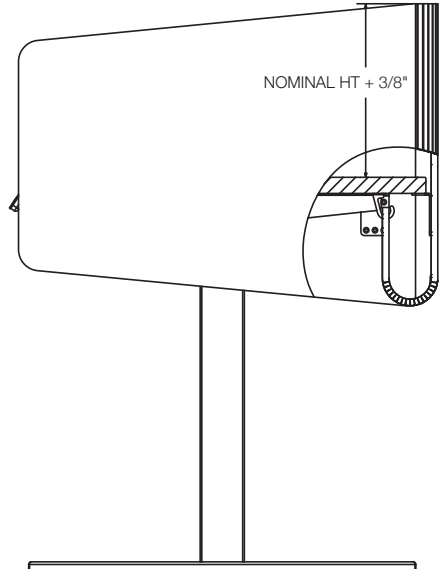

12" and higher surface height shown

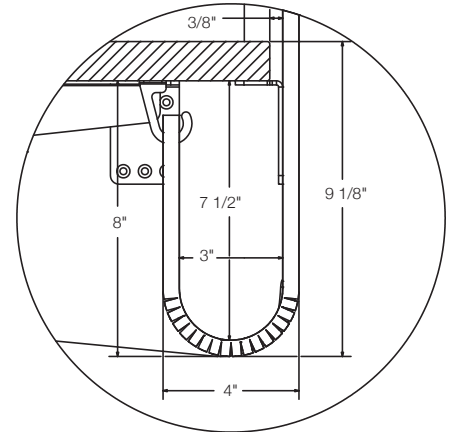

PET Screen with Wire Managers Product Information

PET Screens with Wire Managers Details

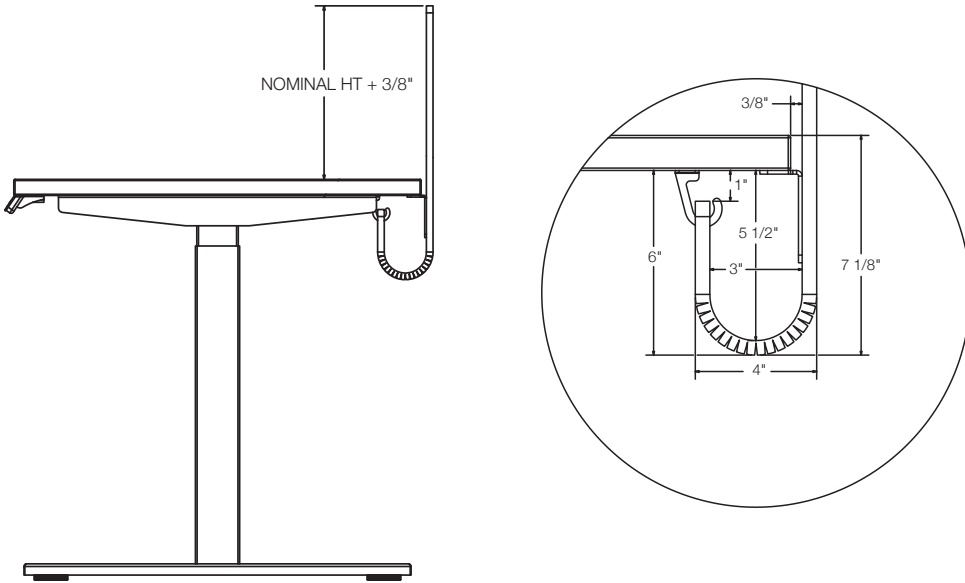

Example shown below is a 12" wide x 54" high lexan 3/8" freestanding clip screen without cut-outs. Guide shown below can be used as a reference, however always refer to the price list pages for product numbers rather than attempting to construct them.

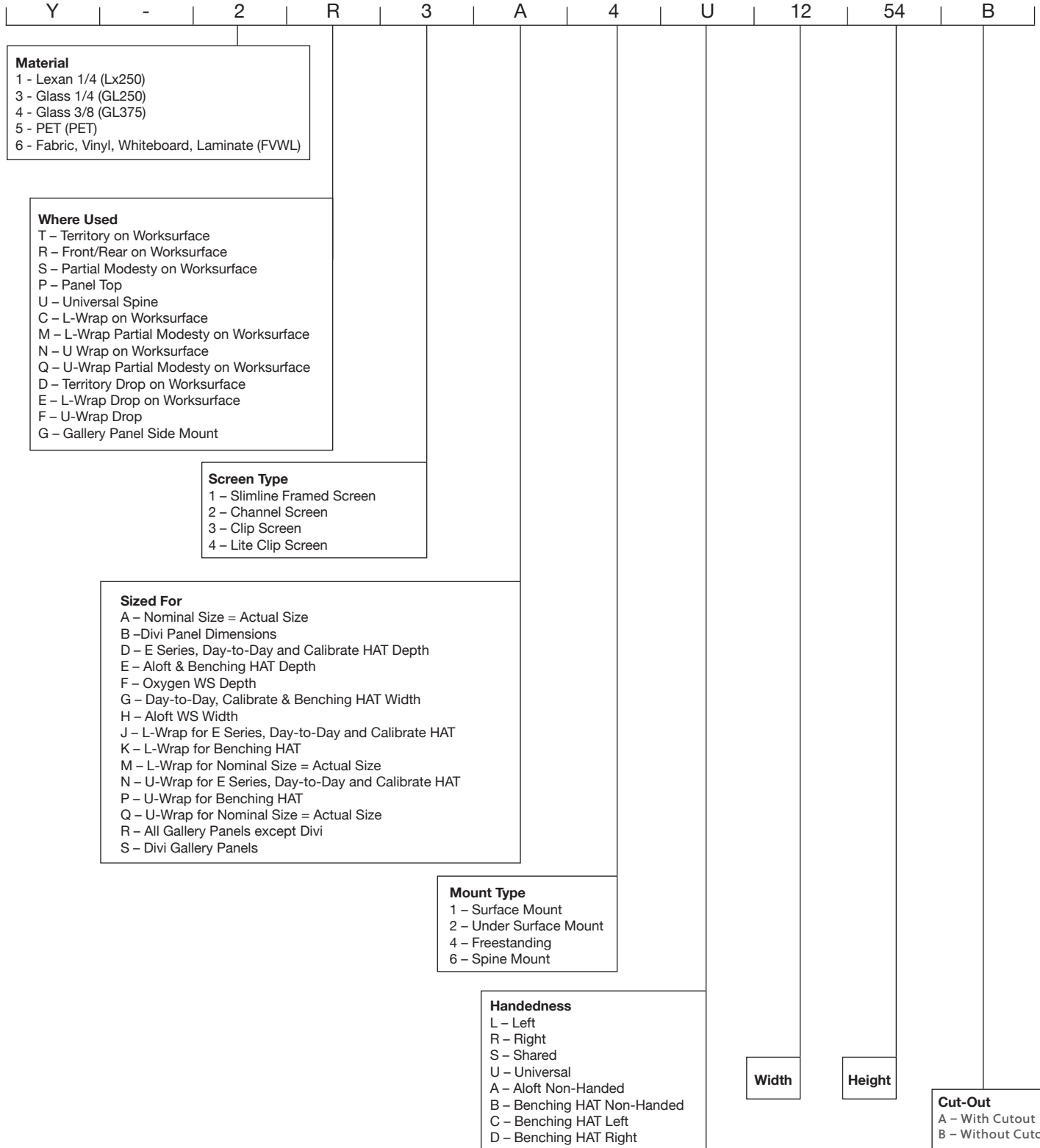

Tackable Fabric Options

VERTICAL SURFACE FABRICS

Name	Grade
Amaze	A
Avenue	A
Cape Cod	A
Engage	A
Mirador	A
New England	A
Rainfall	A
Simplicity	A
Theory	A
Twizzle	A
Lido	B
Marin	B
Nature	B
Off the Grid	B
Purpose	B
Spinel	B
Sprite	B

Note: 66" & 72" wide screens – if applying directional fabrics they will need to be railroaded for application. If using a COM fabric that is 54" wide, any screen over 48" wide would need to have the fabric railroaded as well.

C.O.M. Fabric Policy

- It is mandatory that you work directly with your AIS Customer Service Representative for all COM related testing and orders. They will provide all necessary forms to you, as well as work with you with regard to sending in correct yardage and where to send it, along with necessary RA# or #s. Please note an RA must be submitted along with the fabric for testing, as well as an RA created for an actual order.
- **Please Note:** A three to five yard sample is required for testing and approval for use on all monolithic panel systems. A one yard sample is required for testing and approval on Divi Insert Tiles, Matrix Tiles, flipper doors and tackboards. We may be able to test upholstery fabrics with a swatch, your Customer Service Representative will advise based on the fabric being tested; otherwise a 1 yard sample must be submitted for testing. Results take 48 - 72 hours.
- Customer Service must be advised as to the width of the fabric rolls being supplied (54"W or 60"W). Customer Service must also be advised if the fabric has a backer.
- Yardage required for the job must be calculated by an AIS Customer Service Rep.
- Once AIS has approved the COM fabric, a fabric sample needs to be marked by the dealer with "Front", "Top", and "Bottom", to be sure fabric is applied correctly. The fabric sample then needs to be attached to a COM Fabric Dealer Form and forwarded to AIS Customer Service. [The COM Fabric Dealer Form may be downloaded or printed here.](#)
- Fabrics may be discontinued or obsolete without notice.
- Contact AIS Customer Service with any questions regarding fabric availability.
- All directional fabric will be railroaded.

PAINT OPTIONS

Name	Color Code	Legs / Feet Grade	Spine / Storage / Accessories Grade
Black	BK	A	A
Chalk	CK	-	A
Dark Tone	DT	-	A
Grey Value 1	GV1	-	A
Innertone	HT	-	A
Light Tone	LT	-	A
Medium Tone	MT	-	A
Metallic Silver	MS	A	A
Satin White	SW	A	A
Warm Brown	WB	-	A
Champagne Metallic	CHM	-	B
Dark Grey Metallic	DGM	-	B
Flint Grey Metallic	FGM	-	B
Light Grey	LG	-	B
Tan Value 1	TV1	-	B
Antique Gold	AG	-	C
Graphite Sky	GS	-	C
Burnt Orange	BO	-	C
Brown	BR	-	C
Steel Blue	SB	-	C
Baltic Blue	BB	-	C
Ruby Red	RR	-	C
Kelly Green	KG	-	C

Custom Paints

- Minimum order size for any custom color is \$75,000 list. Extended lead-time will apply.
- Any color not shown on Quick Ship, Standard Grade A, B or C will be considered custom.
- A \$450 net paint match fee will be assessed following receipt of (2) 5"x5" samples of paint being matched.
- Minimum order size for any custom color is \$75,000.00 list. Extended lead-time will apply.
- Additionally, Grade C paint up-charges will be applied to all applicable products on the order.
- **Important Custom Paint Note:** Most paint match pricing can be covered by the Grade C up-charge in the catalog, however the final pricing can only be determined after the paint is matched and a product list is provided to AIS customer service. An additional fee may apply based on job size and paint color.

Laminate Options

LAMINATE OPTIONS	
Name	Grade
Absolute Acajou	A
Aimtoo Savatre	A
Black	A
Brazilwood	A
Chalk	A
Corporate Walnut	A
Dark Rum Cherry	A
Field Elm	A
Grand Cherry	A
Grey Elm	A
Landmark	A
Leave Likatre	A
Linen	A
Looks Likatre	A
Maritime Dune	A
Midwest Maple	A
Neo Walnut	A
Phantom Ecrú	A
Phantom Pearl	A
Storm	A
Summer Drops	A
True White	A
Trytoo Savatre	A
White Chocolate	A
Asian Night	B
Asian Sand	B
Beige Granite	B
Colombian Walnut	B

LAMINATE OPTIONS	
Name	Grade
Gridlock in L.A.	B
Fonthill Pear	B
Grey Mesh	B
Madagascar	B
Mahogany Clove	B
Monticello Maple	B
Nightfall	B
Paris White Potteryware	B
Pewter Mesh	B
Recon Oak	B
Shadow	B
Sunset	B
Titanium EV	B
Tungsten EV	B
White Spektrum	B
Windswept Poweter	B
Yorkshire Cherry	B
Ebony	C
Bright White (Writable Surface)	C
Pecan Woodline	C
Strand Burnt	C
Strand Wedge	C
Strand Wheat	C
Twill Earthen	C
Twill Graphite	C
Twill Sarum	C
Warm White	C

Screens Sized for Nominal = Actual Size

Lexan Nominal = Actual Size Territory Surface Mount Channel Screens

Material	Where Used	Screen Type	Sized For	Mount Type
Lexan 1/4"	Territory on Worksurface	Channel	Nominal = Actual Size	Surface Mount

**LEXAN 1/4" NOMINAL = ACTUAL SIZE
TERRITORY SURFACE MOUNT CHANNEL SCREENS**

H	D	Actual D	Model Number	List
12	24	22.75	Y-1T2A1U1224B	605
16	24	22.75	Y-1T2A1U1624B	655
20	24	22.75	Y-1T2A1U2024B	704
12	30	28.75	Y-1T2A1U1230B	642
16	30	28.75	Y-1T2A1U1630B	704
20	30	28.75	Y-1T2A1U2030B	766

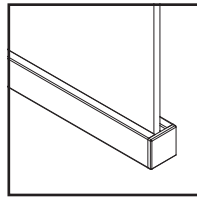
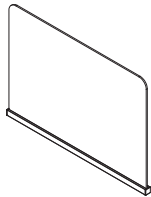

Surface Mount Channel

Specify

- Paint Selection (Grade C +10) (Grade C +10)

Notes

- Offered in all AIS paint finishes.
- Lexan available only in clear.

Glass Nominal = Actual Size Territory Surface Mount Channel Screens

Material	Where Used	Screen Type	Sized For	Mount Type
Glass 1/4"	Territory on Worksurface	Channel	Nominal = Actual Size	Surface Mount

**GLASS 1/4" NOMINAL = ACTUAL SIZE
TERRITORY SURFACE MOUNT CHANNEL SCREENS**

H	D	Actual D	Model Number	List	Tinted Glass	Frosted Glass
12	24	22.75	Y-3T2A1U1224B	535	+30	+110
16	24	22.75	Y-3T2A1U1624B	661	+40	+147
20	24	22.75	Y-3T2A1U2024B	606	+50	+184
24	24	22.75	Y-3T2A1U2424B	647	+60	+220
12	30	28.75	Y-3T2A1U1230B	542	+38	+138
16	30	28.75	Y-3T2A1U1630B	687	+50	+184
20	30	28.75	Y-3T2A1U2030B	659	+63	+230
24	30	28.75	Y-3T2A1U2430B	710	+75	+275

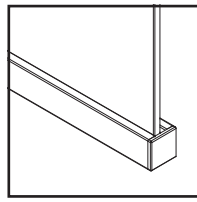
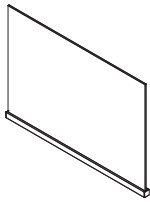

Surface Mount Channel

Specify

- Paint Selection (Grade C +10)

Notes

- Offered in all AIS paint finishes.
- Standard products for glass are always clear unless noted otherwise, other colors may be available upon special request (upcharges apply).

Glass Nominal = Actual Size Territory Surface Mount Channel Screens

Material	Where Used	Screen Type	Sized For	Mount Type
Glass 3/8"	Territory on Worksurface	Channel	Nominal = Actual Size	Surface Mount

**GLASS 3/8" NOMINAL = ACTUAL SIZE
TERRITORY SURFACE MOUNT CHANNEL SCREENS**

H	D	Actual D	Model Number	List	Tinted Glass	Frosted Glass
12	24	22.75	Y-4T2A1U1224B	718	+30	+60
16	24	22.75	Y-4T2A1U1624B	684	+40	+80
20	24	22.75	Y-4T2A1U2024B	780	+50	+100
24	24	22.75	Y-4T2A1U2424B	855	+60	+120
12	30	28.75	Y-4T2A1U1230B	722	+38	+75
16	30	28.75	Y-4T2A1U1630B	764	+50	+100
20	30	28.75	Y-4T2A1U2030B	884	+63	+125
24	30	28.75	Y-4T2A1U2430B	975	+75	+150

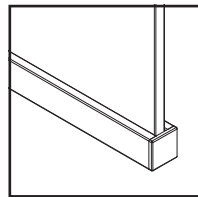
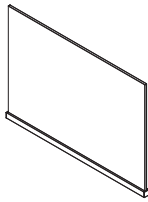

Surface Mount Channel

Specify

- Paint Selection (Grade C +10)

Notes

- Offered in all AIS paint finishes.
- Standard products for glass are always clear unless noted otherwise, other colors may be available upon special request (upcharges apply).

PET Nominal = Actual Size Territory Surface Mount Channel Screens

Material	Where Used	Screen Type	Sized For	Mount Type
PET	Territory on Worksurface	Channel	Nominal = Actual Size	Surface Mount

**PET NOMINAL = ACTUAL SIZE
TERRITORY SURFACE MOUNT CHANNEL SCREENS**

H	D	Actual D	Model Number	List
12	24	22.75	Y-5T2A1U1224B	464
16	24	22.75	Y-5T2A1U1624B	485
20	24	22.75	Y-5T2A1U2024B	507
24	24	22.75	Y-5T2A1U2424B	531
28	24	22.75	Y-5T2A1U2824B	551
32	24	22.75	Y-5T2A1U3224B	574
12	30	28.75	Y-5T2A1U1230B	480
16	30	28.75	Y-5T2A1U1630B	507
20	30	28.75	Y-5T2A1U2030B	535
24	30	28.75	Y-5T2A1U2430B	563
28	30	28.75	Y-5T2A1U2830B	589
32	30	28.75	Y-5T2A1U3230B	616

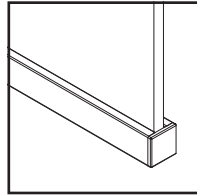
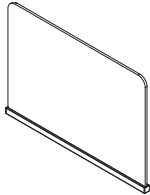

Surface Mount Channel

Specify

• Paint Selection (Grade C +10)

Notes

• Offered in all AIS paint finishes.

Lexan Nominal = Actual Size Territory Under Surface Mount Channel Screens

Material	Where Used	Screen Type	Sized For	Mount Type	Handedness
Lexan 1/4"	Territory on Worksurface	Channel	Nominal = Actual Size	Under Surface Mount	Left or Right

LEXAN 1/4" NOMINAL = ACTUAL SIZE TERRITORY UNDER SURFACE MOUNT CHANNEL SCREENS

H	D	Actual D	Left Hand	Right Hand	List
			Model Number	Model Number	
12	24	22.75	Y-1T2A2L1224B	Y-1T2A2R1224B	735
16	24	22.75	Y-1T2A2L1624B	Y-1T2A2R1624B	786
20	24	22.75	Y-1T2A2L2024B	Y-1T2A2R2024B	834
12	30	28.75	Y-1T2A2L1230B	Y-1T2A2R1230B	771
16	30	28.75	Y-1T2A2L1630B	Y-1T2A2R1630B	834
20	30	28.75	Y-1T2A2L2030B	Y-1T2A2R2030B	897

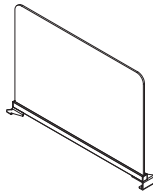

Left Hand

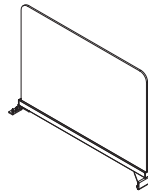

Right Hand

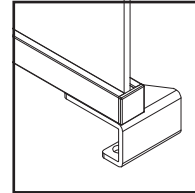

Under Surface Mount Channel

Specify

• Paint Selection (Grade C +10)

Notes

- Offered in all AIS paint finishes.
- Lexan available only in clear.

Glass Nominal = Actual Size Territory Under Surface Mount Channel Screens

Material	Where Used	Screen Type	Sized For	Mount Type	Handedness
Glass 1/4"	Territory on Worksurface	Channel	Nominal = Actual Size	Under Surface Mount	Left or Right

GLASS 1/4" NOMINAL = ACTUAL SIZE TERRITORY UNDER SURFACE MOUNT CHANNEL SCREENS

H	D	Actual D	Left Hand	Right Hand	List	Tinted Glass	Frosted Glass
			Model Number	Model Number			
12	24	22.75	Y-3T2A2L1224B	Y-3T2A2R1224B	665	+30	+110
16	24	22.75	Y-3T2A2L1624B	Y-3T2A2R1624B	791	+40	+147
20	24	22.75	Y-3T2A2L2024B	Y-3T2A2R2024B	736	+50	+184
24	24	22.75	Y-3T2A2L2424B	Y-3T2A2R2424B	777	+60	+220
12	30	28.75	Y-3T2A2L1230B	Y-3T2A2R1230B	672	+38	+138
16	30	28.75	Y-3T2A2L1630B	Y-3T2A2R1630B	816	+50	+184
20	30	28.75	Y-3T2A2L2030B	Y-3T2A2R2030B	790	+63	+230
24	30	28.75	Y-3T2A2L2430B	Y-3T2A2R2430B	840	+75	+275

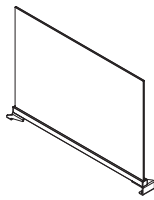

Left Hand

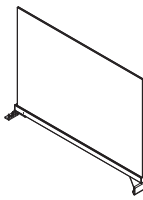

Right Hand

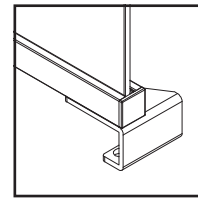

Under Surface Mount Channel

Specify

• Paint Selection (Grade C +10)

Notes

- Offered in all AIS paint finishes.
- Standard products for glass are always clear unless noted otherwise, other colors may be available upon special request (upcharges apply).

Glass Nominal = Actual Size Territory Under Surface Mount Channel Screens

Material	Where Used	Screen Type	Sized For	Mount Type	Handedness
Glass 3/8"	Territory on Worksurface	Channel	Nominal = Actual Size	Under Surface Mount	Left or Right

GLASS 3/8" NOMINAL = ACTUAL SIZE TERRITORY UNDER SURFACE MOUNT CHANNEL SCREENS

H	D	Actual D	Left Hand	Right Hand	List	Tinted Glass	Frosted Glass
			Model Number	Model Number			
12	24	22.75	Y-4T2A2L1224B	Y-4T2A2R1224B	847	+30	+60
16	24	22.75	Y-4T2A2L1624B	Y-4T2A2R1624B	814	+40	+80
20	24	22.75	Y-4T2A2L2024B	Y-4T2A2R2024B	911	+50	+100
24	24	22.75	Y-4T2A2L2424B	Y-4T2A2R2424B	985	+60	+120
12	30	28.75	Y-4T2A2L1230B	Y-4T2A2R1230B	850	+38	+75
16	30	28.75	Y-4T2A2L1630B	Y-4T2A2R1630B	895	+50	+100
20	30	28.75	Y-4T2A2L2030B	Y-4T2A2R2030B	1,015	+63	+125
24	30	28.75	Y-4T2A2L2430B	Y-4T2A2R2430B	1,103	+75	+150

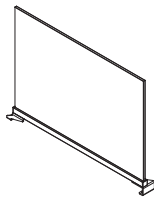

Left Hand

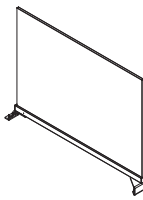

Right Hand

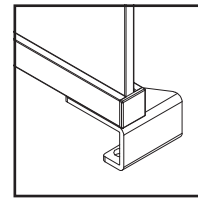

Under Surface Mount Channel

Specify

• Paint Selection (Grade C +10)

Notes

- Offered in all AIS paint finishes.
- Standard products for glass are always clear unless noted otherwise, other colors may be available upon special request (upcharges apply).

PET Nominal = Actual Size Territory Under Surface Mount Channel Screens

Material	Where Used	Screen Type	Sized For	Mount Type	Handedness
PET	Territory on Worksurface	Channel	Nominal = Actual Size	Under Surface Mount	Left or Right

PET NOMINAL = ACTUAL SIZE TERRITORY UNDER SURFACE MOUNT CHANNEL SCREENS

H	D	Actual D	Left Hand	Right Hand	List
			Model Number	Model Number	
12	24	22.75	Y-5T2A2L1224B	Y-5T2A2R1224B	593
16	24	22.75	Y-5T2A2L1624B	Y-5T2A2R1624B	615
20	24	22.75	Y-5T2A2L2024B	Y-5T2A2R2024B	638
24	24	22.75	Y-5T2A2L2424B	Y-5T2A2R2424B	659
28	24	22.75	Y-5T2A2L2824B	Y-5T2A2R2824B	682
32	24	22.75	Y-5T2A2L3224B	Y-5T2A2R3224B	704
12	30	28.75	Y-5T2A2L1230B	Y-5T2A2R1230B	610
16	30	28.75	Y-5T2A2L1630B	Y-5T2A2R1630B	638
20	30	28.75	Y-5T2A2L2030B	Y-5T2A2R2030B	665
24	30	28.75	Y-5T2A2L2430B	Y-5T2A2R2430B	693
28	30	28.75	Y-5T2A2L2830B	Y-5T2A2R2830B	720
32	30	28.75	Y-5T2A2L3230B	Y-5T2A2R3230B	747

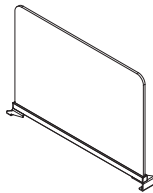

Left Hand

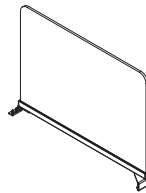

Right Hand

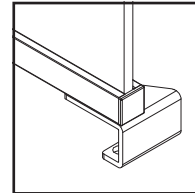

Under Surface Mount Channel

Specify

- Paint Selection (Grade C +10)
- Color Selection for PET - Lite Grey, Medium Grey, Tan or Vibrant Blue

Notes

- Offered in all AIS paint finishes.

Lexan Nominal = Actual Size Front/Rear Surface Mount Channel Screens

Material	Where Used	Screen Type	Sized For	Mount Type
Lexan 1/4"	Front/Rear on Worksurface	Channel	Nominal = Actual Size	Surface Mount

LEXAN 1/4" NOMINAL = ACTUAL SIZE FRONT/REAR SURFACE MOUNT CHANNEL SCREENS

H	W	Model Number	List
12	24	Y-1R2A1U1224B	605
12	30	Y-1R2A1U1230B	642
12	36	Y-1R2A1U1236B	679
12	42	Y-1R2A1U1242B	717
12	48	Y-1R2A1U1248B	755
12	54	Y-1R2A1U1254B	791
12	60	Y-1R2A1U1260B	829
12	66	Y-1R2A1U1266B	867
12	72	Y-1R2A1U1272B	903
12	78	Y-1R2A1U1278B	939
12	84	Y-1R2A1U1284B	976
16	24	Y-1R2A1U1624B	655
16	30	Y-1R2A1U1630B	704
16	36	Y-1R2A1U1636B	755
16	42	Y-1R2A1U1642B	804
16	48	Y-1R2A1U1648B	855
16	54	Y-1R2A1U1654B	903
16	60	Y-1R2A1U1660B	954
16	66	Y-1R2A1U1666B	1,002
16	72	Y-1R2A1U1672B	1,052
16	78	Y-1R2A1U1678B	1,102
16	84	Y-1R2A1U1684B	1,154

LEXAN 1/4" NOMINAL = ACTUAL SIZE FRONT/REAR SURFACE MOUNT CHANNEL SCREENS

H	W	Model Number	List
20	24	Y-1R2A1U2024B	704
20	30	Y-1R2A1U2030B	766
20	36	Y-1R2A1U2036B	829
20	42	Y-1R2A1U2042B	890
20	48	Y-1R2A1U2048B	954
20	54	Y-1R2A1U2054B	1,017
20	60	Y-1R2A1U2060B	1,080
20	66	Y-1R2A1U2066B	1,141
20	72	Y-1R2A1U2072B	1,204
20	78	Y-1R2A1U2078B	1,267
20	84	Y-1R2A1U2084B	1,329

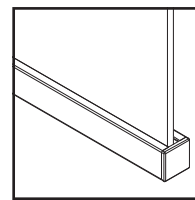
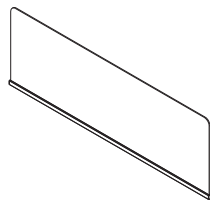

Surface Mount Channel

Specify

• Paint Selection (Grade C +10)

Notes

- Offered in all AIS paint finishes.
- Lexan available only in clear.

Glass Nominal = Actual Size Front/Rear Surface Mount Channel Screens

Material	Where Used	Screen Type	Sized For	Mount Type
Glass 1/4"	Front/Rear on Worksurface	Channel	Nominal = Actual Size	Surface Mount

GLASS 1/4" NOMINAL = ACTUAL SIZE FRONT/REAR SURFACE MOUNT CHANNEL SCREENS

H	W	Model Number	List	Tinted Glass	Frosted Glass
12	24	Y-3R2A1U1224B	535	+30	+110
12	30	Y-3R2A1U1230B	542	+38	+138
12	36	Y-3R2A1U1236B	549	+45	+165
12	42	Y-3R2A1U1242B	578	+53	+193
12	48	Y-3R2A1U1248B	607	+60	+220
12	54	Y-3R2A1U1254B	727	+68	+248
12	60	Y-3R2A1U1260B	666	+75	+275
12	66	Y-3R2A1U1266B	695	+83	+303
12	72	Y-3R2A1U1272B	724	+90	+330
12	78	Y-3R2A1U1278B	753	+98	+358
12	84	Y-3R2A1U1284B	779	+105	+385
16	24	Y-3R2A1U1624B	661	+40	+147
16	30	Y-3R2A1U1630B	687	+50	+184
16	36	Y-3R2A1U1636B	727	+60	+220
16	42	Y-3R2A1U1642B	756	+70	+257
16	48	Y-3R2A1U1648B	789	+80	+294
16	54	Y-3R2A1U1654B	840	+90	+330
16	60	Y-3R2A1U1660B	887	+100	+367
16	66	Y-3R2A1U1666B	899	+110	+404
16	72	Y-3R2A1U1672B	920	+120	+440
16	78	Y-3R2A1U1678B	937	+130	+477
16	84	Y-3R2A1U1684B	954	+140	+514

GLASS 1/4" NOMINAL = ACTUAL SIZE FRONT/REAR SURFACE MOUNT CHANNEL SCREENS

H	W	Model Number	List	Tinted Glass	Frosted Glass
20	24	Y-3R2A1U2024B	606	+50	+184
20	30	Y-3R2A1U2030B	659	+63	+230
20	36	Y-3R2A1U2036B	695	+75	+275
20	42	Y-3R2A1U2042B	765	+88	+321
20	48	Y-3R2A1U2048B	816	+100	+367
20	54	Y-3R2A1U2054B	869	+113	+413
20	60	Y-3R2A1U2060B	922	+125	+459
20	66	Y-3R2A1U2066B	975	+138	+505
20	72	Y-3R2A1U2072B	1,028	+150	+550
20	78	Y-3R2A1U2078B	1,082	+163	+596
20	84	Y-3R2A1U2084B	1,133	+175	+642
24	24	Y-3R2A1U2424B	647	+60	+220
24	30	Y-3R2A1U2430B	710	+75	+275
24	36	Y-3R2A1U2436B	773	+90	+330
24	42	Y-3R2A1U2442B	834	+105	+385
24	48	Y-3R2A1U2448B	897	+120	+440
24	54	Y-3R2A1U2454B	958	+135	+495
24	60	Y-3R2A1U2460B	1,021	+150	+550
24	66	Y-3R2A1U2466B	1,085	+165	+605
24	72	Y-3R2A1U2472B	1,145	+180	+660
24	78	Y-3R2A1U2478B	1,206	+195	+715
24	84	Y-3R2A1U2484B	1,267	+210	+770

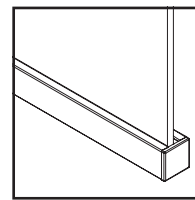
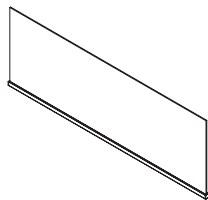

Surface Mount Channel

Specify

- Paint Selection (Grade C +10)

Notes

- Offered in all AIS paint finishes.
- Standard products for glass are always clear unless noted otherwise, other colors may be available upon special request (upcharges apply).

Glass Nominal = Actual Size Front/Rear Surface Mount Channel Screens

Material	Where Used	Screen Type	Sized For	Mount Type
Glass 3/8"	Front/Rear on Worksurface	Channel	Nominal = Actual Size	Surface Mount

GLASS 3/8" NOMINAL = ACTUAL SIZE FRONT/REAR SURFACE MOUNT CHANNEL SCREENS

H	W	Model Number	List	Tinted Glass	Frosted Glass
12	24	Y-4R2A1U1224B	718	+30	+60
12	30	Y-4R2A1U1230B	722	+38	+75
12	36	Y-4R2A1U1236B	786	+45	+90
12	42	Y-4R2A1U1242B	848	+53	+105
12	48	Y-4R2A1U1248B	914	+60	+120
12	54	Y-4R2A1U1254B	979	+68	+135
12	60	Y-4R2A1U1260B	1,045	+75	+150
12	66	Y-4R2A1U1266B	1,109	+83	+165
12	72	Y-4R2A1U1272B	1,173	+90	+180
12	78	Y-4R2A1U1278B	1,239	+98	+195
12	84	Y-4R2A1U1284B	1,304	+105	+210
16	24	Y-4R2A1U1624B	684	+40	+80
16	30	Y-4R2A1U1630B	764	+50	+100
16	36	Y-4R2A1U1636B	801	+60	+120
16	42	Y-4R2A1U1642B	891	+70	+140
16	48	Y-4R2A1U1648B	988	+80	+160
16	54	Y-4R2A1U1654B	1,056	+90	+180
16	60	Y-4R2A1U1660B	1,087	+100	+200
16	66	Y-4R2A1U1666B	1,184	+110	+220
16	72	Y-4R2A1U1672B	1,258	+120	+240
16	78	Y-4R2A1U1678B	1,280	+130	+260
16	84	Y-4R2A1U1684B	1,344	+140	+280

GLASS 3/8" NOMINAL = ACTUAL SIZE FRONT/REAR SURFACE MOUNT CHANNEL SCREENS

H	W	Model Number	List	Tinted Glass	Frosted Glass
20	24	Y-4R2A1U2024B	780	+50	+100
20	30	Y-4R2A1U2030B	884	+63	+125
20	36	Y-4R2A1U2036B	984	+75	+150
20	42	Y-4R2A1U2042B	1,086	+88	+175
20	48	Y-4R2A1U2048B	1,184	+100	+200
20	54	Y-4R2A1U2054B	1,287	+113	+225
20	60	Y-4R2A1U2060B	1,387	+125	+250
20	66	Y-4R2A1U2066B	1,489	+138	+275
20	72	Y-4R2A1U2072B	1,587	+150	+300
20	78	Y-4R2A1U2078B	1,687	+163	+325
20	84	Y-4R2A1U2084B	1,788	+175	+350
24	24	Y-4R2A1U2424B	855	+60	+120
24	30	Y-4R2A1U2430B	975	+75	+150
24	36	Y-4R2A1U2436B	1,093	+90	+180
24	42	Y-4R2A1U2442B	1,212	+105	+210
24	48	Y-4R2A1U2448B	1,331	+120	+240
24	54	Y-4R2A1U2454B	1,450	+135	+270
24	60	Y-4R2A1U2460B	1,571	+150	+300
24	66	Y-4R2A1U2466B	1,690	+165	+330
24	72	Y-4R2A1U2472B	1,807	+180	+360
24	78	Y-4R2A1U2478B	1,925	+195	+390
24	84	Y-4R2A1U2484B	2,044	+210	+420

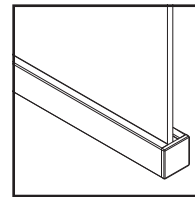
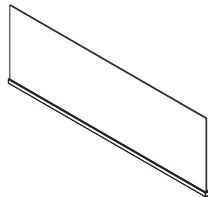

Surface Mount Channel

Specify

• Paint Selection (Grade C +10)

Notes

• Offered in all AIS paint finishes.

• Standard products for glass are always clear unless noted otherwise, other colors may be available upon special request (upcharges apply).

PET Nominal = Actual Size Front/Rear Surface Mount Channel Screens

Material	Where Used	Screen Type	Sized For	Mount Type
PET	Front/Rear on Worksurface	Channel	Nominal = Actual Size	Surface Mount

**PET NOMINAL = ACTUAL SIZE
FRONT/REAR SURFACE MOUNT CHANNEL SCREENS**

H	W	Model Number	List
28	24	Y-5R2A1U2824B	551
28	30	Y-5R2A1U2830B	589
28	36	Y-5R2A1U2836B	627
28	42	Y-5R2A1U2842B	666
28	48	Y-5R2A1U2848B	705
28	54	Y-5R2A1U2854B	742
28	60	Y-5R2A1U2860B	779
28	66	Y-5R2A1U2866B	820
28	72	Y-5R2A1U2872B	858
28	78	Y-5R2A1U2878B	897
28	84	Y-5R2A1U2884B	935
32	24	Y-5R2A1U3224B	574
32	30	Y-5R2A1U3230B	616
32	36	Y-5R2A1U3236B	659
32	42	Y-5R2A1U3242B	705
32	48	Y-5R2A1U3248B	748
32	54	Y-5R2A1U3254B	791
32	60	Y-5R2A1U3260B	835
32	66	Y-5R2A1U3266B	877
32	72	Y-5R2A1U3272B	922
32	78	Y-5R2A1U3278B	966
32	84	Y-5R2A1U3284B	1,010

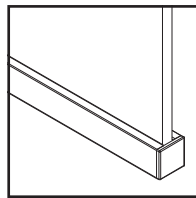
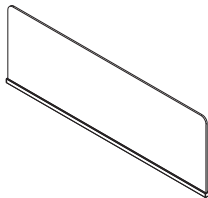

Surface Mount Channel

Specify

- Paint Selection (Grade C +10)
- Color Selection for PET - Lite Grey, Medium Grey, Tan or Vibrant Blue

Notes

- Offered in all AIS paint finishes.

Lexan Nominal = Actual Size Front/Rear Under Surface Mount Channel Screens

Material	Where Used	Screen Type	Sized For	Mount Type
Lexan 1/4"	Front/Rear on Worksurface	Channel	Nominal = Actual Size	Under Surface Mount

**LEXAN 1/4" NOMINAL = ACTUAL SIZE
FRONT/REAR UNDER SURFACE MOUNT CHANNEL SCREENS**

H	W	Model Number	List
12	24	Y-1R2A2U1224B	735
12	30	Y-1R2A2U1230B	771
12	36	Y-1R2A2U1236B	808
12	42	Y-1R2A2U1242B	846
12	48	Y-1R2A2U1248B	885
12	54	Y-1R2A2U1254B	921
12	60	Y-1R2A2U1260B	958
12	66	Y-1R2A2U1266B	996
12	72	Y-1R2A2U1272B	1,032
12	78	Y-1R2A2U1278B	1,069
12	84	Y-1R2A2U1284B	1,105
16	24	Y-1R2A2U1624B	786
16	30	Y-1R2A2U1630B	834
16	36	Y-1R2A2U1636B	885
16	42	Y-1R2A2U1642B	935
16	48	Y-1R2A2U1648B	985
16	54	Y-1R2A2U1654B	1,032
16	60	Y-1R2A2U1660B	1,085
16	66	Y-1R2A2U1666B	1,132
16	72	Y-1R2A2U1672B	1,182
16	78	Y-1R2A2U1678B	1,233
16	84	Y-1R2A2U1684B	1,284

**LEXAN 1/4" NOMINAL = ACTUAL SIZE
FRONT/REAR UNDER SURFACE MOUNT CHANNEL SCREENS**

H	W	Model Number	List
20	24	Y-1R2A2U2024B	834
20	30	Y-1R2A2U2030B	897
20	36	Y-1R2A2U2036B	958
20	42	Y-1R2A2U2042B	1,021
20	48	Y-1R2A2U2048B	1,085
20	54	Y-1R2A2U2054B	1,146
20	60	Y-1R2A2U2060B	1,210
20	66	Y-1R2A2U2066B	1,272
20	72	Y-1R2A2U2072B	1,333
20	78	Y-1R2A2U2078B	1,396
20	84	Y-1R2A2U2084B	1,460

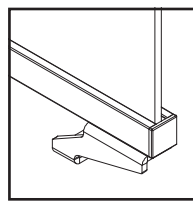
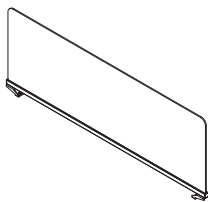

Under Surface Mount Channel

Specify

• Paint Selection (Grade C +10)

Notes

- Offered in all AIS paint finishes.
- Lexan available only in clear.

Glass Nominal = Actual Size Front/Rear Under Surface Mount Channel Screens

Material	Where Used	Screen Type	Sized For	Mount Type
Glass 1/4"	Front/Rear on Worksurface	Channel	Nominal = Actual Size	Under Surface Mount

**GLASS 1/4" NOMINAL = ACTUAL SIZE
FRONT/REAR UNDER SURFACE MOUNT CHANNEL SCREENS**

H	W	Model Number	List	Tinted Glass	Frosted Glass
12	24	Y-3R2A2U1224B	665	+30	+110
12	30	Y-3R2A2U1230B	672	+38	+138
12	36	Y-3R2A2U1236B	680	+45	+165
12	42	Y-3R2A2U1242B	709	+53	+193
12	48	Y-3R2A2U1248B	737	+60	+220
12	54	Y-3R2A2U1254B	858	+68	+248
12	60	Y-3R2A2U1260B	796	+75	+275
12	66	Y-3R2A2U1266B	826	+83	+303
12	72	Y-3R2A2U1272B	854	+90	+330
12	78	Y-3R2A2U1278B	881	+98	+358
12	84	Y-3R2A2U1284B	910	+105	+385
16	24	Y-3R2A2U1624B	791	+40	+147
16	30	Y-3R2A2U1630B	816	+50	+184
16	36	Y-3R2A2U1636B	858	+60	+220
16	42	Y-3R2A2U1642B	886	+70	+257
16	48	Y-3R2A2U1648B	918	+80	+294
16	54	Y-3R2A2U1654B	970	+90	+330
16	60	Y-3R2A2U1660B	1,018	+100	+367
16	66	Y-3R2A2U1666B	1,029	+110	+404
16	72	Y-3R2A2U1672B	1,050	+120	+440
16	78	Y-3R2A2U1678B	1,066	+130	+477
16	84	Y-3R2A2U1684B	1,085	+140	+514

**GLASS 1/4" NOMINAL = ACTUAL SIZE
FRONT/REAR UNDER SURFACE MOUNT CHANNEL SCREENS**

H	W	Model Number	List	Tinted Glass	Frosted Glass
20	24	Y-3R2A2U2024B	736	+50	+184
20	30	Y-3R2A2U2030B	790	+63	+230
20	36	Y-3R2A2U2036B	826	+75	+275
20	42	Y-3R2A2U2042B	896	+88	+321
20	48	Y-3R2A2U2048B	947	+100	+367
20	54	Y-3R2A2U2054B	998	+113	+413
20	60	Y-3R2A2U2060B	1,052	+125	+459
20	66	Y-3R2A2U2066B	1,103	+138	+505
20	72	Y-3R2A2U2072B	1,158	+150	+550
20	78	Y-3R2A2U2078B	1,211	+163	+596
20	84	Y-3R2A2U2084B	1,263	+175	+642
24	24	Y-3R2A2U2424B	777	+60	+220
24	30	Y-3R2A2U2430B	840	+75	+275
24	36	Y-3R2A2U2436B	903	+90	+330
24	42	Y-3R2A2U2442B	964	+105	+385
24	48	Y-3R2A2U2448B	1,026	+120	+440
24	54	Y-3R2A2U2454B	1,089	+135	+495
24	60	Y-3R2A2U2460B	1,151	+150	+550
24	66	Y-3R2A2U2466B	1,213	+165	+605
24	72	Y-3R2A2U2472B	1,275	+180	+660
24	78	Y-3R2A2U2478B	1,334	+195	+715
24	84	Y-3R2A2U2484B	1,396	+210	+770

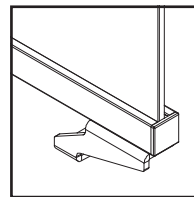
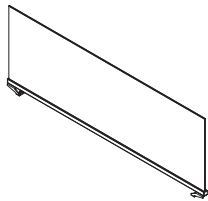

Under Surface Mount Channel

Specify

• Paint Selection (Grade C +10)

Notes

- Offered in all AIS paint finishes.
- Standard products for glass are always clear unless noted otherwise, other colors may be available upon special request (upcharges apply).

Glass Nominal = Actual Size Front/Rear Under Surface Mount Channel Screens

Material	Where Used	Screen Type	Sized For	Mount Type
Glass 3/8"	Front/Rear on Worksurface	Channel	Nominal = Actual Size	Under Surface Mount

**GLASS 3/8" NOMINAL = ACTUAL SIZE
FRONT/REAR UNDER SURFACE MOUNT CHANNEL SCREENS**

H	W	Model Number	List	Tinted Glass	Frosted Glass
12	24	Y-4R2A2U1224B	847	+30	+60
12	30	Y-4R2A2U1230B	850	+38	+75
12	36	Y-4R2A2U1236B	914	+45	+90
12	42	Y-4R2A2U1242B	979	+53	+105
12	48	Y-4R2A2U1248B	1,045	+60	+120
12	54	Y-4R2A2U1254B	1,109	+68	+135
12	60	Y-4R2A2U1260B	1,173	+75	+150
12	66	Y-4R2A2U1266B	1,239	+83	+165
12	72	Y-4R2A2U1272B	1,304	+90	+180
12	78	Y-4R2A2U1278B	1,369	+98	+195
12	84	Y-4R2A2U1284B	1,434	+105	+210
16	24	Y-4R2A2U1624B	814	+40	+80
16	30	Y-4R2A2U1630B	895	+50	+100
16	36	Y-4R2A2U1636B	931	+60	+120
16	42	Y-4R2A2U1642B	1,022	+70	+140
16	48	Y-4R2A2U1648B	1,118	+80	+160
16	54	Y-4R2A2U1654B	1,184	+90	+180
16	60	Y-4R2A2U1660B	1,217	+100	+200
16	66	Y-4R2A2U1666B	1,315	+110	+220
16	72	Y-4R2A2U1672B	1,388	+120	+240
16	78	Y-4R2A2U1678B	1,410	+130	+260
16	84	Y-4R2A2U1684B	1,474	+140	+280

**GLASS 3/8" NOMINAL = ACTUAL SIZE
FRONT/REAR UNDER SURFACE MOUNT CHANNEL SCREENS**

H	W	Model Number	List	Tinted Glass	Frosted Glass
20	24	Y-4R2A2U2024B	911	+50	+100
20	30	Y-4R2A2U2030B	1,015	+63	+125
20	36	Y-4R2A2U2036B	1,113	+75	+150
20	42	Y-4R2A2U2042B	1,214	+88	+175
20	48	Y-4R2A2U2048B	1,315	+100	+200
20	54	Y-4R2A2U2054B	1,417	+113	+225
20	60	Y-4R2A2U2060B	1,516	+125	+250
20	66	Y-4R2A2U2066B	1,617	+138	+275
20	72	Y-4R2A2U2072B	1,718	+150	+300
20	78	Y-4R2A2U2078B	1,817	+163	+325
20	84	Y-4R2A2U2084B	1,917	+175	+350
24	24	Y-4R2A2U2424B	985	+60	+120
24	30	Y-4R2A2U2430B	1,103	+75	+150
24	36	Y-4R2A2U2436B	1,223	+90	+180
24	42	Y-4R2A2U2442B	1,343	+105	+210
24	48	Y-4R2A2U2448B	1,462	+120	+240
24	54	Y-4R2A2U2454B	1,581	+135	+270
24	60	Y-4R2A2U2460B	1,700	+150	+300
24	66	Y-4R2A2U2466B	1,818	+165	+330
24	72	Y-4R2A2U2472B	1,938	+180	+360
24	78	Y-4R2A2U2478B	2,056	+195	+390
24	84	Y-4R2A2U2484B	2,175	+210	+420

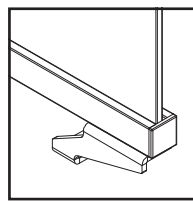
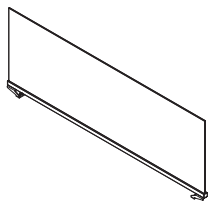

Under Surface Mount Channel

Specify

• Paint Selection (Grade C +10)

Notes

- Offered in all AIS paint finishes.
- Standard products for glass are always clear unless noted otherwise, other colors may be available upon special request (upcharges apply).

PET Nominal = Actual Size Front/Rear Under Surface Mount Channel Screens

Material	Where Used	Screen Type	Sized For	Mount Type
PET	Front/Rear on Worksurface	Channel	Nominal = Actual Size	Under Surface Mount

**PET NOMINAL = ACTUAL SIZE
FRONT/REAR UNDER SURFACE MOUNT CHANNEL SCREENS**

H	W	Model Number	List
12	24	Y-5R2A2U1224B	593
12	30	Y-5R2A2U1230B	610
12	36	Y-5R2A2U1236B	627
12	42	Y-5R2A2U1242B	643
12	48	Y-5R2A2U1248B	659
12	54	Y-5R2A2U1254B	677
12	60	Y-5R2A2U1260B	693
12	66	Y-5R2A2U1266B	709
12	72	Y-5R2A2U1272B	725
12	78	Y-5R2A2U1278B	740
12	84	Y-5R2A2U1284B	758
16	24	Y-5R2A2U1624B	615
16	30	Y-5R2A2U1630B	638
16	36	Y-5R2A2U1636B	659
16	42	Y-5R2A2U1642B	682
16	48	Y-5R2A2U1648B	704
16	54	Y-5R2A2U1654B	725
16	60	Y-5R2A2U1660B	747
16	66	Y-5R2A2U1666B	768
16	72	Y-5R2A2U1672B	791
16	78	Y-5R2A2U1678B	813
16	84	Y-5R2A2U1684B	835

**PET NOMINAL = ACTUAL SIZE
FRONT/REAR UNDER SURFACE MOUNT CHANNEL SCREENS**

H	W	Model Number	List
20	24	Y-5R2A2U2024B	638
20	30	Y-5R2A2U2030B	665
20	36	Y-5R2A2U2036B	693
20	42	Y-5R2A2U2042B	720
20	48	Y-5R2A2U2048B	748
20	54	Y-5R2A2U2054B	775
20	60	Y-5R2A2U2060B	803
20	66	Y-5R2A2U2066B	830
20	72	Y-5R2A2U2072B	858
20	78	Y-5R2A2U2078B	885
20	84	Y-5R2A2U2084B	911
24	24	Y-5R2A2U2424B	659
24	30	Y-5R2A2U2430B	693
24	36	Y-5R2A2U2436B	725
24	42	Y-5R2A2U2442B	759
24	48	Y-5R2A2U2448B	791
24	54	Y-5R2A2U2454B	825
24	60	Y-5R2A2U2460B	858
24	66	Y-5R2A2U2466B	889
24	72	Y-5R2A2U2472B	922
24	78	Y-5R2A2U2478B	955
24	84	Y-5R2A2U2484B	989

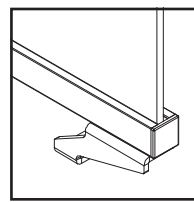
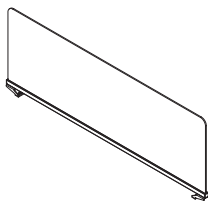

Under Surface Mount Channel

Specify

- Paint Selection (Grade C +10)
- Color Selection for PET - Lite Grey, Medium Grey, Tan or Vibrant Blue

Notes

- Offered in all AIS paint finishes.

PET Nominal = Actual Size Front/Rear Under Surface Mount Channel Screens

Material	Where Used	Screen Type	Sized For	Mount Type
PET	Front/Rear on Worksurface	Channel	Nominal = Actual Size	Under Surface Mount

PET FRONT/REAR UNDER SURFACE MOUNT CHANNEL SCREENS (ACTUAL DIMENSION)

H	W	Model Number	List
28	24	Y-5R2A2U2824B	682
28	30	Y-5R2A2U2830B	720
28	36	Y-5R2A2U2836B	758
28	42	Y-5R2A2U2842B	796
28	48	Y-5R2A2U2848B	835
28	54	Y-5R2A2U2854B	873
28	60	Y-5R2A2U2860B	910
28	66	Y-5R2A2U2866B	950
28	72	Y-5R2A2U2872B	988
28	78	Y-5R2A2U2878B	1,026
28	84	Y-5R2A2U2884B	1,063
32	24	Y-5R2A2U3224B	704
32	30	Y-5R2A2U3230B	747
32	36	Y-5R2A2U3236B	790
32	42	Y-5R2A2U3242B	835
32	48	Y-5R2A2U3248B	877
32	54	Y-5R2A2U3254B	921
32	60	Y-5R2A2U3260B	965
32	66	Y-5R2A2U3266B	1,008
32	72	Y-5R2A2U3272B	1,052
32	78	Y-5R2A2U3278B	1,097
32	84	Y-5R2A2U3284B	1,140

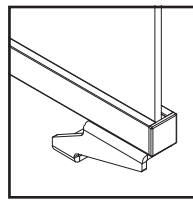
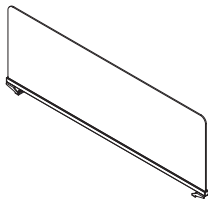

Under Surface Mount Channel

Specify

- Paint Selection (Grade C +10)
- Color Selection for PET - Lite Grey, Medium Grey, Tan or Vibrant Blue

Notes

- Offered in all AIS paint finishes.

Lexan Nominal = Actual Size Panel Top Surface Mount Channel Screens

Material	Where Used	Screen Type	Sized For	Mount Type
Lexan 1/4"	Panel Top	Channel	Nominal = Actual Size	Surface Mount

**LEXAN 1/4" NOMINAL = ACTUAL SIZE
PANEL TOP SURFACE MOUNT CHANNEL SCREENS**

H	W	Model Number	List
12	24	Y-1P2A1U1224B	605
12	30	Y-1P2A1U1230B	642
12	36	Y-1P2A1U1236B	679
12	42	Y-1P2A1U1242B	717
12	48	Y-1P2A1U1248B	755
12	54	Y-1P2A1U1254B	791
12	60	Y-1P2A1U1260B	829
12	66	Y-1P2A1U1266B	867
12	72	Y-1P2A1U1272B	903
12	78	Y-1P2A1U1278B	939
12	84	Y-1P2A1U1284B	976
16	24	Y-1P2A1U1624B	655
16	30	Y-1P2A1U1630B	704
16	36	Y-1P2A1U1636B	755
16	42	Y-1P2A1U1642B	804
16	48	Y-1P2A1U1648B	855
16	54	Y-1P2A1U1654B	903
16	60	Y-1P2A1U1660B	954
16	66	Y-1P2A1U1666B	1,002
16	72	Y-1P2A1U1672B	1,052
16	78	Y-1P2A1U1678B	1,102
16	84	Y-1P2A1U1684B	1,154

**LEXAN 1/4" NOMINAL = ACTUAL SIZE
PANEL TOP SURFACE MOUNT CHANNEL SCREENS**

H	W	Model Number	List
20	24	Y-1P2A1U2024B	704
20	30	Y-1P2A1U2030B	766
20	36	Y-1P2A1U2036B	829
20	42	Y-1P2A1U2042B	890
20	48	Y-1P2A1U2048B	954
20	54	Y-1P2A1U2054B	1,017
20	60	Y-1P2A1U2060B	1,080
20	66	Y-1P2A1U2066B	1,141
20	72	Y-1P2A1U2072B	1,204
20	78	Y-1P2A1U2078B	1,267
20	84	Y-1P2A1U2084B	1,329

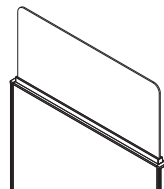
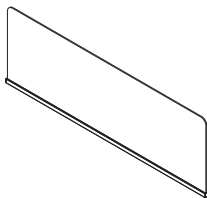

On Panel Top

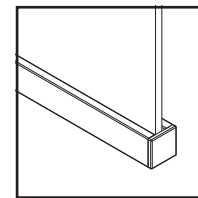

Surface Mount Channel

Specify

• Paint Selection (Grade C +10)

Notes

- Can not be used on Matrix or Divi. For Matrix see Matrix price list, for Divi see section in Screens price list.
- Offered in all AIS paint finishes.
- Lexan available only in clear.

Glass Nominal = Actual Size Panel Top Surface Mount Channel Screens

Material	Where Used	Screen Type	Sized For	Mount Type
Glass 1/4"	Panel Top	Channel	Nominal = Actual Size	Surface Mount

**GLASS 1/4" NOMINAL = ACTUAL SIZE
PANEL TOP SURFACE MOUNT CHANNEL SCREENS**

H	W	Model Number	List	Tinted Glass	Frosted Glass
8	24	Y-3P2A1U0824B	432	+30	+110
8	30	Y-3P2A1U0830B	463	+38	+138
8	36	Y-3P2A1U0836B	493	+45	+165
8	42	Y-3P2A1U0842B	523	+53	+193
8	48	Y-3P2A1U0848B	553	+60	+220
8	54	Y-3P2A1U0854B	584	+68	+248
8	60	Y-3P2A1U0860B	614	+75	+275
8	66	Y-3P2A1U0866B	644	+83	+303
8	72	Y-3P2A1U0872B	674	+90	+330
8	78	Y-3P2A1U0878B	705	+98	+358
8	84	Y-3P2A1U0884B	735	+105	+385
12	24	Y-3P2A1U1224B	535	+30	+110
12	30	Y-3P2A1U1230B	542	+38	+138
12	36	Y-3P2A1U1236B	549	+45	+165
12	42	Y-3P2A1U1242B	578	+53	+193
12	48	Y-3P2A1U1248B	607	+60	+220
12	54	Y-3P2A1U1254B	727	+68	+248
12	60	Y-3P2A1U1260B	666	+75	+275
12	66	Y-3P2A1U1266B	695	+83	+303
12	72	Y-3P2A1U1272B	724	+90	+330
12	78	Y-3P2A1U1278B	753	+98	+358
12	84	Y-3P2A1U1284B	779	+105	+385

**GLASS 1/4" NOMINAL = ACTUAL SIZE
PANEL TOP SURFACE MOUNT CHANNEL SCREENS**

H	W	Model Number	List	Tinted Glass	Frosted Glass
16	24	Y-3P2A1U1624B	661	+40	+147
16	30	Y-3P2A1U1630B	687	+50	+184
16	36	Y-3P2A1U1636B	727	+60	+220
16	42	Y-3P2A1U1642B	756	+70	+257
16	48	Y-3P2A1U1648B	789	+80	+294
16	54	Y-3P2A1U1654B	840	+90	+330
16	60	Y-3P2A1U1660B	887	+100	+367
16	66	Y-3P2A1U1666B	899	+110	+404
16	72	Y-3P2A1U1672B	920	+120	+440
16	78	Y-3P2A1U1678B	937	+130	+477
16	84	Y-3P2A1U1684B	954	+140	+514

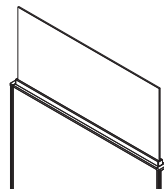
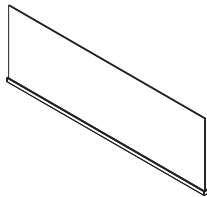

On Panel Top

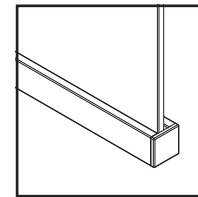

Surface Mount Channel

Specify

• Paint Selection (Grade C +10)

Notes

- Can not be used on Matrix or Divi. For Matrix see Matrix price list, for Divi see section in Screens price list.
- Offered in all AIS paint finishes.
- Standard products for glass are always clear unless noted otherwise, other colors may be available upon special request (upcharges apply).

Glass Nominal = Actual Size Panel Top Surface Mount Channel Screens

Material	Where Used	Screen Type	Sized For	Mount Type
Glass 1/4"	Panel Top	Channel	Nominal = Actual Size	Surface Mount

**GLASS 1/4" NOMINAL = ACTUAL SIZE
PANEL TOP SURFACE MOUNT CHANNEL SCREENS**

H	W	Model Number	List	Tinted Glass	Frosted Glass
20	24	Y-3P2A1U2024B	606	+50	+184
20	30	Y-3P2A1U2030B	659	+63	+230
20	36	Y-3P2A1U2036B	695	+75	+275
20	42	Y-3P2A1U2042B	765	+88	+321
20	48	Y-3P2A1U2048B	816	+100	+367
20	54	Y-3P2A1U2054B	869	+113	+413
20	60	Y-3P2A1U2060B	922	+125	+459
20	66	Y-3P2A1U2066B	975	+138	+505
20	72	Y-3P2A1U2072B	1,028	+150	+550
20	78	Y-3P2A1U2078B	1,082	+163	+596
20	84	Y-3P2A1U2084B	1,133	+175	+642

**GLASS 1/4" NOMINAL = ACTUAL SIZE
PANEL TOP SURFACE MOUNT CHANNEL SCREENS**

H	W	Model Number	List	Tinted Glass	Frosted Glass
24	24	Y-3P2A1U2424B	647	+60	+220
24	30	Y-3P2A1U2430B	710	+75	+275
24	36	Y-3P2A1U2436B	773	+90	+330
24	42	Y-3P2A1U2442B	834	+105	+385
24	48	Y-3P2A1U2448B	897	+120	+440
24	54	Y-3P2A1U2454B	958	+135	+495
24	60	Y-3P2A1U2460B	1,021	+150	+550
24	66	Y-3P2A1U2466B	1,085	+165	+605
24	72	Y-3P2A1U2472B	1,145	+180	+660
24	78	Y-3P2A1U2478B	1,206	+195	+715
24	84	Y-3P2A1U2484B	1,267	+210	+770

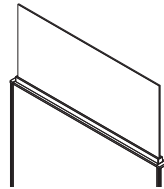
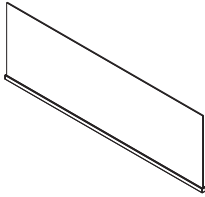

On Panel Top

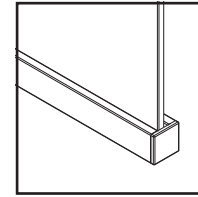

Surface Mount Channel

Specify

- Paint Selection (Grade C +10)

Notes

- Can not be used on Matrix or Divi. For Matrix see Matrix price list, for Divi see section in Screens price list.
- Offered in all AIS paint finishes.
- Standard products for glass are always clear unless noted otherwise, other colors may be available upon special request (upcharges apply).

Glass Nominal = Actual Size Panel Top Surface Mount Channel Screens

Material	Where Used	Screen Type	Sized For	Mount Type
Glass 3/8"	Panel Top	Channel	Nominal = Actual Size	Surface Mount

**GLASS 3/8" NOMINAL = ACTUAL SIZE
PANEL TOP SURFACE MOUNT CHANNEL SCREENS**

H	W	Model Number	List	Tinted Glass	Frosted Glass
8	24	Y-4P2A1U0824B	648	+30	+60
8	30	Y-4P2A1U0830B	702	+38	+75
8	36	Y-4P2A1U0836B	756	+45	+90
8	42	Y-4P2A1U0842B	810	+53	+105
8	48	Y-4P2A1U0848B	864	+60	+120
8	54	Y-4P2A1U0854B	918	+68	+135
8	60	Y-4P2A1U0860B	972	+75	+150
8	66	Y-4P2A1U0866B	1,026	+83	+165
8	72	Y-4P2A1U0872B	1,080	+90	+180
8	78	Y-4P2A1U0878B	1,134	+98	+195
8	84	Y-4P2A1U0884B	1,188	+105	+210
12	24	Y-4P2A1U1224B	718	+30	+60
12	30	Y-4P2A1U1230B	722	+38	+75
12	36	Y-4P2A1U1236B	786	+45	+90
12	42	Y-4P2A1U1242B	848	+53	+105
12	48	Y-4P2A1U1248B	914	+60	+120
12	54	Y-4P2A1U1254B	979	+68	+135
12	60	Y-4P2A1U1260B	1,045	+75	+150
12	66	Y-4P2A1U1266B	1,109	+83	+165
12	72	Y-4P2A1U1272B	1,173	+90	+180
12	78	Y-4P2A1U1278B	1,239	+98	+195
12	84	Y-4P2A1U1284B	1,304	+105	+210

**GLASS 3/8" NOMINAL = ACTUAL SIZE
PANEL TOP SURFACE MOUNT CHANNEL SCREENS**

H	W	Model Number	List	Tinted Glass	Frosted Glass
16	24	Y-4P2A1U1624B	684	+40	+80
16	30	Y-4P2A1U1630B	764	+50	+100
16	36	Y-4P2A1U1636B	801	+60	+120
16	42	Y-4P2A1U1642B	891	+70	+140
16	48	Y-4P2A1U1648B	988	+80	+160
16	54	Y-4P2A1U1654B	1,056	+90	+180
16	60	Y-4P2A1U1660B	1,087	+100	+200
16	66	Y-4P2A1U1666B	1,184	+110	+220
16	72	Y-4P2A1U1672B	1,258	+120	+240
16	78	Y-4P2A1U1678B	1,280	+130	+260
16	84	Y-4P2A1U1684B	1,344	+140	+280

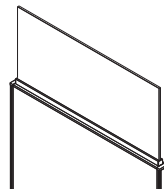
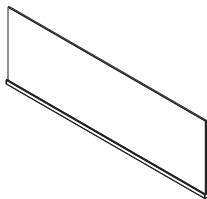

On Panel Top

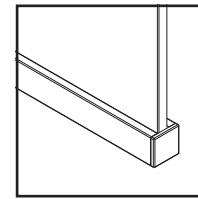

Surface Mount Channel

Specify

• Paint Selection (Grade C +10)

Notes

- Can not be used on Matrix or Divi. For Matrix see Matrix price list, for Divi see section in Screens price list.
- Offered in all AIS paint finishes.
- Standard products for glass are always clear unless noted otherwise, other colors may be available upon special request (upcharges apply).

Glass Nominal = Actual Size Panel Top Surface Mount Channel Screens

Material	Where Used	Screen Type	Sized For	Mount Type
Glass 3/8"	Panel Top	Channel	Nominal = Actual Size	Surface Mount

**GLASS 3/8" NOMINAL = ACTUAL SIZE
PANEL TOP SURFACE MOUNT CHANNEL SCREENS**

H	W	Model Number	List	Tinted Glass	Frosted Glass
20	24	Y-4P2A1U2024B	780	+50	+100
20	30	Y-4P2A1U2030B	884	+63	+125
20	36	Y-4P2A1U2036B	984	+75	+150
20	42	Y-4P2A1U2042B	1,086	+88	+175
20	48	Y-4P2A1U2048B	1,184	+100	+200
20	54	Y-4P2A1U2054B	1,287	+113	+225
20	60	Y-4P2A1U2060B	1,387	+125	+250
20	66	Y-4P2A1U2066B	1,489	+138	+275
20	72	Y-4P2A1U2072B	1,587	+150	+300
20	78	Y-4P2A1U2078B	1,687	+163	+325
20	84	Y-4P2A1U2084B	1,788	+175	+350

**GLASS 3/8" NOMINAL = ACTUAL SIZE
PANEL TOP SURFACE MOUNT CHANNEL SCREENS**

H	W	Model Number	List	Tinted Glass	Frosted Glass
24	24	Y-4P2A1U2424B	855	+50	+100
24	30	Y-4P2A1U2430B	975	+63	+125
24	36	Y-4P2A1U2436B	1,093	+75	+150
24	42	Y-4P2A1U2442B	1,212	+88	+175
24	48	Y-4P2A1U2448B	1,331	+100	+200
24	54	Y-4P2A1U2454B	1,450	+113	+225
24	60	Y-4P2A1U2460B	1,571	+125	+250
24	66	Y-4P2A1U2466B	1,690	+138	+275
24	72	Y-4P2A1U2472B	1,807	+150	+300
24	78	Y-4P2A1U2478B	1,925	+163	+325
24	84	Y-4P2A1U2484B	2,044	+175	+350

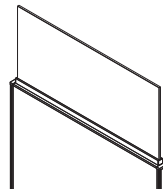
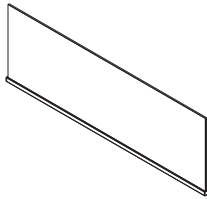

On Panel Top

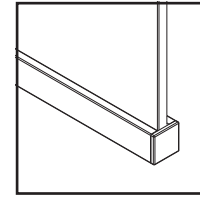

Surface Mount Channel

Specify

- Paint Selection (Grade C +10)

Notes

- Can not be used on Matrix or Divi. For Matrix see Matrix price list, for Divi see section in Screens price list.
- Offered in all AIS paint finishes.
- Standard products for glass are always clear unless noted otherwise, other colors may be available upon special request (upcharges apply).

PET Nominal = Actual Size Panel Top Surface Mount Channel Screens

Material	Where Used	Screen Type	Sized For	Mount Type
PET	Panel Top	Channel	Nominal = Actual Size	Surface Mount

**PET NOMINAL = ACTUAL SIZE
PANEL TOP SURFACE MOUNT CHANNEL SCREENS**

H	W	Model Number	List
12	24	Y-5P2A1U1224B	464
12	30	Y-5P2A1U1230B	480
12	36	Y-5P2A1U1236B	497
12	42	Y-5P2A1U1242B	512
12	48	Y-5P2A1U1248B	531
12	54	Y-5P2A1U1254B	546
12	60	Y-5P2A1U1260B	563
12	66	Y-5P2A1U1266B	578
12	72	Y-5P2A1U1272B	594
12	78	Y-5P2A1U1278B	612
12	84	Y-5P2A1U1284B	627
16	24	Y-5P2A1U1624B	485
16	30	Y-5P2A1U1630B	507
16	36	Y-5P2A1U1636B	531
16	42	Y-5P2A1U1642B	551
16	48	Y-5P2A1U1648B	574
16	54	Y-5P2A1U1654B	594
16	60	Y-5P2A1U1660B	616
16	66	Y-5P2A1U1666B	639
16	72	Y-5P2A1U1672B	661
16	78	Y-5P2A1U1678B	683
16	84	Y-5P2A1U1684B	705

**PET NOMINAL = ACTUAL SIZE
PANEL TOP SURFACE MOUNT CHANNEL SCREENS**

H	W	Model Number	List
20	24	Y-5P2A1U2024B	507
20	30	Y-5P2A1U2030B	535
20	36	Y-5P2A1U2036B	563
20	42	Y-5P2A1U2042B	589
20	48	Y-5P2A1U2048B	617
20	54	Y-5P2A1U2054B	645
20	60	Y-5P2A1U2060B	673
20	66	Y-5P2A1U2066B	699
20	72	Y-5P2A1U2072B	727
20	78	Y-5P2A1U2078B	755
20	84	Y-5P2A1U2084B	780
24	24	Y-5P2A1U2424B	531
24	30	Y-5P2A1U2430B	563
24	36	Y-5P2A1U2436B	594
24	42	Y-5P2A1U2442B	628
24	48	Y-5P2A1U2448B	661
24	54	Y-5P2A1U2454B	694
24	60	Y-5P2A1U2460B	727
24	66	Y-5P2A1U2466B	760
24	72	Y-5P2A1U2472B	793
24	78	Y-5P2A1U2478B	826
24	84	Y-5P2A1U2484B	859

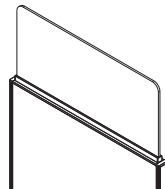
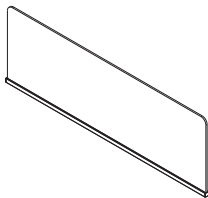

On Panel Top

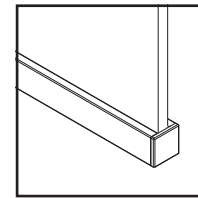

Surface Mount Channel

Specify

- Paint Selection (Grade C +10)
- Color Selection for PET - Lite Grey, Medium Grey, Tan or Vibrant Blue

Notes

- Can not be used on Matrix or Divi. For Matrix see Matrix price list, for Divi see section in Screens price list.
- Offered in all AIS paint finishes.

PET Nominal = Actual Size Panel Top Surface Mount Channel Screens

Material	Where Used	Screen Type	Sized For	Mount Type
PET	Panel Top	Channel	Nominal = Actual Size	Surface Mount

**PET NOMINAL = ACTUAL SIZE
PANEL TOP SURFACE MOUNT CHANNEL SCREENS**

H	W	Model Number	List
28	24	Y-5P2A1U2824B	551
28	30	Y-5P2A1U2830B	589
28	36	Y-5P2A1U2836B	627
28	42	Y-5P2A1U2842B	666
28	48	Y-5P2A1U2848B	705
28	54	Y-5P2A1U2854B	742
28	60	Y-5P2A1U2860B	779
28	66	Y-5P2A1U2866B	820
28	72	Y-5P2A1U2872B	858
28	78	Y-5P2A1U2878B	897
28	84	Y-5P2A1U2884B	935
32	24	Y-5P2A1U3224B	574
32	30	Y-5P2A1U3230B	616
32	36	Y-5P2A1U3236B	659
32	42	Y-5P2A1U3242B	705
32	48	Y-5P2A1U3248B	748
32	54	Y-5P2A1U3254B	791
32	60	Y-5P2A1U3260B	835
32	66	Y-5P2A1U3266B	877
32	72	Y-5P2A1U3272B	922
32	78	Y-5P2A1U3278B	966
32	84	Y-5P2A1U3284B	1,010

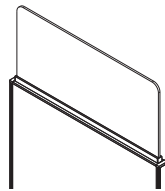
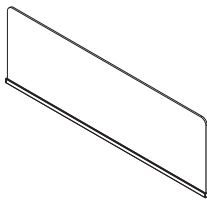

On Panel Top

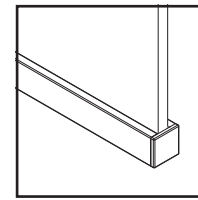

Surface Mount Channel

Specify

- Paint Selection (Grade C +10)
- Color Selection for PET - Lite Grey, Medium Grey, Tan or Vibrant Blue

Notes

- Can not be used on Matrix or Divi. For Matrix see Matrix price list, for Divi see section in Screens price list.
- Offered in all AIS paint finishes.

Lexan Gallery Panel Side Mount Channel Screens

Material	Where Used	Screen Type	Sized For	Mount Type
Lexan 3/8"	Gallery Panel Side Mount	Channel	All Gallery Panels except Divi	Surface Mount

LEXAN 3/8" GALLERY PANEL SIDE MOUNT CHANNEL SCREENS

H	W	Model Number	List
42	12	Y-2G2R1U4212B	885
42	18	Y-2G2R1U4218B	918
42	24	Y-2G2R1U4224B	947
46	12	Y-2G2R1U4612B	1,073
46	18	Y-2G2R1U4618B	1,138
46	24	Y-2G2R1U4624B	1,106
50	12	Y-2G2R1U5012B	1,157
50	18	Y-2G2R1U5018B	1,201
50	24	Y-2G2R1U5024B	1,393
58	12	Y-2G2R1U5812B	1,489
58	18	Y-2G2R1U5818B	1,329
58	24	Y-2G2R1U5824B	1,383
66	12	Y-2G2R1U6612B	1,455
66	18	Y-2G2R1U6618B	1,710
66	24	Y-2G2R1U6624B	1,836

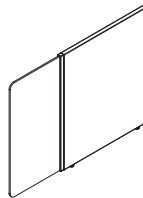

On Gallery Panel

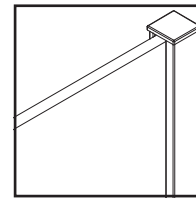

Surface Mount Channel

Specify

• Paint Selection (Grade C +10)

Notes

- Can not be used with Divi.
- Offered in all AIS paint finishes.
- Lexan available only in clear.

PET Gallery Panel Side Mount Channel Screens

Material	Where Used	Screen Type	Sized For	Mount Type
PET	Gallery Panel Side Mount	Channel	All Gallery Panels except Divi	Surface Mount

PET GALLERY PANEL SIDE MOUNT CHANNEL SCREENS

H	W	Model Number	List
42	12	Y-5G2R1U4212B	495
42	18	Y-5G2R1U4218B	504
42	24	Y-5G2R1U4224B	511
46	12	Y-5G2R1U4612B	543
46	18	Y-5G2R1U4618B	559
46	24	Y-5G2R1U4624B	549
50	12	Y-5G2R1U5012B	564
50	18	Y-5G2R1U5018B	574
50	24	Y-5G2R1U5024B	623
58	12	Y-5G2R1U5812B	645
58	18	Y-5G2R1U5818B	606
58	24	Y-5G2R1U5824B	624
66	12	Y-5G2R1U6612B	638
66	18	Y-5G2R1U6618B	702
66	24	Y-5G2R1U6624B	734

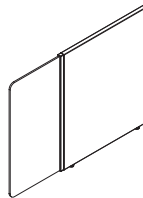

On Gallery Panel

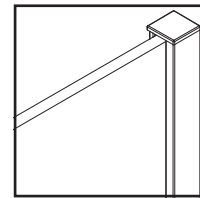

Surface Mount Channel

Specify

Notes

- Paint Selection (Grade C +10)
- Color Selection for PET - Lite Grey, Medium Grey, Tan or Vibrant Blue

- Can not be used with Divi.
- Offered in all AIS paint finishes.

Lexan Nominal = Actual Size Territory Surface Mount Clip Screens

Material	Where Used	Screen Type	Sized For	Mount Type
Lexan 1/4"	Territory on Worksurface	Clip	Nominal = Actual Size	Surface Mount

**LEXAN 1/4" NOMINAL = ACTUAL SIZE
TERRITORY SURFACE MOUNT CLIP SCREENS WITHOUT CUT-OUTS**

H	D	Model Number	List
12	24	Y-1T3A1U1224B	605
16	24	Y-1T3A1U1624B	655
20	24	Y-1T3A1U2024B	704
12	30	Y-1T3A1U1230B	642
16	30	Y-1T3A1U1630B	704
20	30	Y-1T3A1U2030B	766

**LEXAN 1/4" NOMINAL = ACTUAL SIZE
TERRITORY SURFACE MOUNT CLIP SCREENS WITH CUT-OUTS**

H	D	Model Number	List
12	24	Y-1T3A1U1224A	605
16	24	Y-1T3A1U1624A	655
20	24	Y-1T3A1U2024A	704
12	30	Y-1T3A1U1230A	642
16	30	Y-1T3A1U1630A	704
20	30	Y-1T3A1U2030A	766

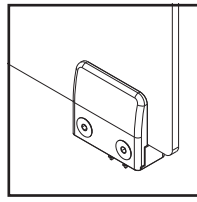
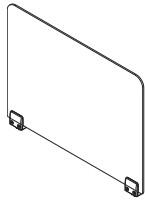

Surface Mount Clip

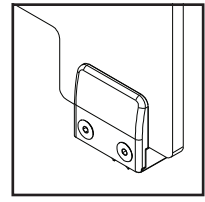
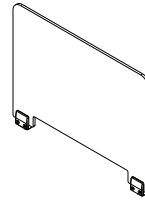

Surface Mount Clip

Specify

Notes

- Clips available in Metallic Silver only.
- Lexan available only in clear.

Glass Nominal = Actual Size Territory Surface Mount Clip Screens

Material	Where Used	Screen Type	Sized For	Mount Type
Glass 1/4"	Territory on Worksurface	Clip	Nominal = Actual Size	Surface Mount

**GLASS 1/4" NOMINAL = ACTUAL SIZE
TERRITORY SURFACE MOUNT CLIP SCREENS**

H	D	Model Number	List	Tinted Glass	Frosted Glass
12	24	Y-3T3A1U1224B	535	+30	+110
16	24	Y-3T3A1U1624B	661	+40	+147
20	24	Y-3T3A1U2024B	606	+50	+184
24	24	Y-3T3A1U2424B	647	+60	+220
12	30	Y-3T3A1U1230B	542	+38	+138
16	30	Y-3T3A1U1630B	687	+50	+184
20	30	Y-3T3A1U2030B	659	+63	+230
24	30	Y-3T3A1U2430B	710	+75	+275

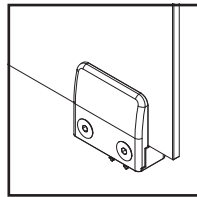
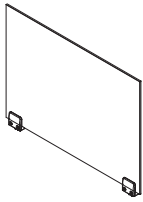

Surface Mount Clip

Specify

Notes

- Clips available in Metallic Silver only.
- Standard products for glass are always clear unless noted otherwise, other colors may be available upon special request (upcharges apply).

Glass Nominal = Actual Size Territory Surface Mount Clip Screens

Material	Where Used	Screen Type	Sized For	Mount Type
Glass 3/8"	Territory on Worksurface	Clip	Nominal = Actual Size	Surface Mount

**GLASS 3/8" NOMINAL = ACTUAL SIZE
TERRITORY SURFACE MOUNT CLIP SCREENS**

H	D	Model Number	List	Tinted Glass	Frosted Glass
12	24	Y-4T3A1U1224B	718	+30	+60
16	24	Y-4T3A1U1624B	684	+40	+80
20	24	Y-4T3A1U2024B	780	+50	+100
24	24	Y-4T3A1U2424B	855	+60	+120
12	30	Y-4T3A1U1230B	722	+38	+75
16	30	Y-4T3A1U1630B	764	+50	+100
20	30	Y-4T3A1U2030B	884	+63	+125
24	30	Y-4T3A1U2430B	975	+75	+150

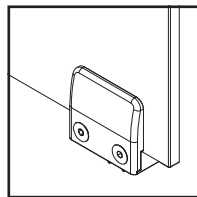
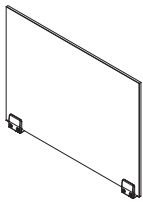

Surface Mount Clip

Specify

Notes

- Clips available in Metallic Silver only.
- Standard products for glass are always clear unless noted otherwise, other colors may be available upon special request (upcharges apply).

Lexan Nominal = Actual Size Territory Under Surface Mount Clip Screens

Material	Where Used	Screen Type	Sized For	Mount Type	Handedness
Lexan 1/4"	Territory on Worksurface	Clip	Nominal = Actual Size	Under Surface Mount	Left or Right

LEXAN 1/4" NOMINAL = ACTUAL SIZE TERRITORY UNDER SURFACE MOUNT CLIP SCREENS WITHOUT CUT-OUTS

H	D	Actual D	Left Hand	Right Hand	List
			Model Number	Model Number	
12	24	23	Y-1T3A2L1224B	Y-1T3A2R1224B	605
16	24	23	Y-1T3A2L1624B	Y-1T3A2R1624B	655
20	24	23	Y-1T3A2L2024B	Y-1T3A2R2024B	704
12	30	29	Y-1T3A2L1230B	Y-1T3A2R1230B	642
16	30	29	Y-1T3A2L1630B	Y-1T3A2R1630B	704
20	30	29	Y-1T3A2L2030B	Y-1T3A2R2030B	766

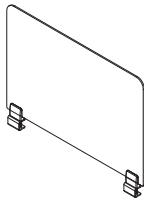

Left Hand

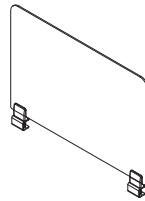

Right Hand

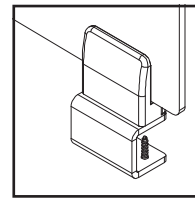

Under Surface Mount Clip

Specify

Notes

- Clips available in Metallic Silver only.
- Lexan available only in clear.

Lexan Nominal = Actual Size Territory Under Surface Mount Clip Screens

Material	Where Used	Screen Type	Sized For	Mount Type	Handedness
Lexan 1/4"	Territory on Worksurface	Clip	Nominal = Actual Size	Under Surface Mount	Left or Right

LEXAN 1/4" NOMINAL = ACTUAL SIZE TERRITORY UNDER SURFACE MOUNT CLIP SCREENS WITH CUT-OUTS

H	D	Actual D	Left Hand	Right Hand	List
			Model Number	Model Number	
12	24	23	Y-1T3A2L1224A	Y-1T3A2R1224A	605
16	24	23	Y-1T3A2L1624A	Y-1T3A2R1230A	655
20	24	23	Y-1T3A2L2024A	Y-1T3A2R1624A	704
12	30	29	Y-1T3A2L1230A	Y-1T3A2R2024A	642
16	30	29	Y-1T3A2L1630A	Y-1T3A2R2030A	704
20	30	29	Y-1T3A2L2030A	Y-1T3A2R2424A	766

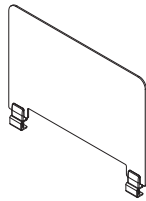

Left Hand

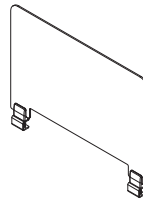

Right Hand

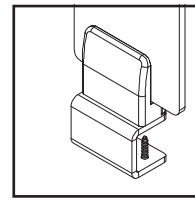

Under Surface Mount Clip

Specify

Notes

- Clips available in Metallic Silver only.
- Lexan available only in clear.

Glass Nominal = Actual Size Territory Under Surface Mount Clip Screens

Material	Where Used	Screen Type	Sized For	Mount Type	Handedness
Glass 1/4"	Territory on Worksurface	Clip	Nominal = Actual Size	Under Surface Mount	Left or Right

GLASS 1/4" NOMINAL = ACTUAL SIZE TERRITORY UNDER SURFACE MOUNT CLIP SCREENS

H	D	Actual D	Left Hand	Right Hand	List	Tinted Glass	Frosted Glass
			Model Number	Model Number			
12	24	23	Y-3T3A2L1224B	Y-3T3A2R1224B	535	+30	+110
16	24	23	Y-3T3A2L1624B	Y-3T3A2R1624B	661	+40	+147
20	24	23	Y-3T3A2L2024B	Y-3T3A2R2024B	606	+50	+184
24	24	23	Y-3T3A2L2424B	Y-3T3A2R2424B	647	+60	+220
12	30	29	Y-3T3A2L1230B	Y-3T3A2R1230B	542	+38	+138
16	30	29	Y-3T3A2L1630B	Y-3T3A2R1630B	687	+50	+184
20	30	29	Y-3T3A2L2030B	Y-3T3A2R2030B	659	+63	+230
24	30	29	Y-3T3A2L2430B	Y-3T3A2R2430B	710	+75	+275

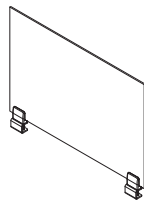

Left Hand

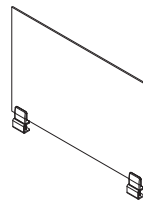

Right Hand

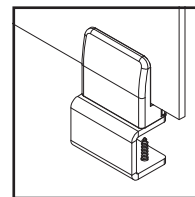

Under Surface Mount Clip

Specify

Notes

- Clips available in Metallic Silver only.
- Standard products for glass are always clear unless noted otherwise, other colors may be available upon special request (upcharges apply).

Glass Nominal = Actual Size Territory Under Surface Mount Clip Screens

Material	Where Used	Screen Type	Sized For	Mount Type	Handedness
Glass 3/8"	Territory on Worksurface	Clip	Nominal = Actual Size	Under Surface Mount	Left or Right

GLASS 3/8" NOMINAL = ACTUAL SIZE TERRITORY UNDER SURFACE MOUNT CLIP SCREENS

H	D	Actual D	Left Hand	Right Hand	List	Tinted Glass	Frosted Glass
			Model Number	Model Number			
12	24	23	Y-4T3A2L1224B	Y-4T3A2R1224B	718	+30	+60
16	24	23	Y-4T3A2L1624B	Y-4T3A2R1624B	684	+40	+80
20	24	23	Y-4T3A2L2024B	Y-4T3A2R2024B	780	+50	+100
24	24	23	Y-4T3A2L2424B	Y-4T3A2R2424B	855	+60	+120
12	30	29	Y-4T3A2L1230B	Y-4T3A2R1230B	722	+38	+75
16	30	29	Y-4T3A2L1630B	Y-4T3A2R1630B	764	+50	+100
20	30	29	Y-4T3A2L2030B	Y-4T3A2R2030B	884	+63	+125
24	30	29	Y-4T3A2L2430B	Y-4T3A2R2430B	975	+75	+150

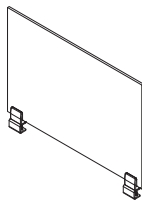

Left Hand

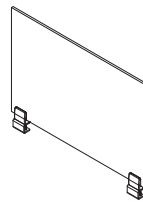

Right Hand

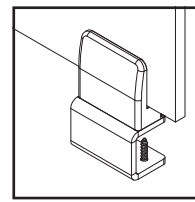

Under Surface Mount Clip

Specify

Notes

- Clips available in Metallic Silver only.
- Standard products for glass are always clear unless noted otherwise, other colors may be available upon special request (upcharges apply).

Lexan Nominal = Actual Size Territory Freestanding Clip Screens

Material	Where Used	Screen Type	Sized For	Mount Type
Lexan 1/4"	Territory on Worksurface	Clip	Nominal = Actual Size	Freestanding

**LEXAN 1/4" NOMINAL = ACTUAL SIZE
TERRITORY FREESTANDING CLIP SCREENS WITHOUT CUT-OUTS**

H	D	Model Number	List
12	24	Y-1T3A4U1224B	735
16	24	Y-1T3A4U1624B	786
20	24	Y-1T3A4U2024B	834
12	30	Y-1T3A4U1230B	771
16	30	Y-1T3A4U1630B	834
20	30	Y-1T3A4U2030B	897

**LEXAN 1/4" NOMINAL = ACTUAL SIZE
TERRITORY FREESTANDING CLIP SCREENS WITH CUT-OUTS**

H	D	Model Number	List
12	24	Y-1T3A4U1224A	735
16	24	Y-1T3A4U1624A	786
20	24	Y-1T3A4U2024A	834
12	30	Y-1T3A4U1230A	771
16	30	Y-1T3A4U1630A	834
20	30	Y-1T3A4U2030A	897

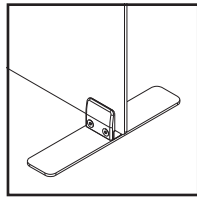
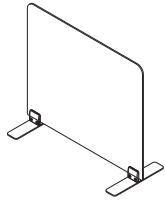

Freestanding Clip

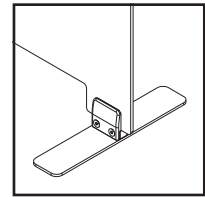
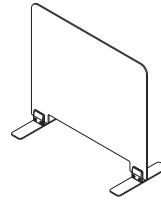

Freestanding Clip

Specify

Notes

- Clips available in Metallic Silver only.
- Lexan available only in clear.
- Non-marring feet measure 2 3/8" x 12".

Lexan Nominal = Actual Size Front/Rear Surface Mount Clip Screens

Material	Where Used	Screen Type	Sized For	Mount Type
Lexan 1/4"	Front/Rear on Worksurface	Clip	Nominal = Actual Size	Surface Mount

**LEXAN 1/4" NOMINAL = ACTUAL SIZE
FRONT/REAR SURFACE MOUNT CLIP SCREENS WITHOUT CUT-OUTS**

H	W	Model Number	List
12	24	Y-1R3A1U1224B	605
12	30	Y-1R3A1U1230B	642
12	36	Y-1R3A1U1236B	679
12	42	Y-1R3A1U1242B	717
12	48	Y-1R3A1U1248B	755
12	54	Y-1R3A1U1254B	791
12	60	Y-1R3A1U1260B	829
12	66	Y-1R3A1U1266B	867
12	72	Y-1R3A1U1272B	903
12	78	Y-1R3A1U1278B	939
12	84	Y-1R3A1U1284B	976
16	24	Y-1R3A1U1624B	655
16	30	Y-1R3A1U1630B	704
16	36	Y-1R3A1U1636B	755
16	42	Y-1R3A1U1642B	804
16	48	Y-1R3A1U1648B	855
16	54	Y-1R3A1U1654B	903
16	60	Y-1R3A1U1660B	954
16	66	Y-1R3A1U1666B	1,002
16	72	Y-1R3A1U1672B	1,052
16	78	Y-1R3A1U1678B	1,102
16	84	Y-1R3A1U1684B	1,154

**LEXAN 1/4" NOMINAL = ACTUAL SIZE
FRONT/REAR SURFACE MOUNT CLIP SCREENS WITHOUT CUT-OUTS**

H	W	Model Number	List
20	24	Y-1R3A1U2024B	704
20	30	Y-1R3A1U2030B	766
20	36	Y-1R3A1U2036B	829
20	42	Y-1R3A1U2042B	890
20	48	Y-1R3A1U2048B	954
20	54	Y-1R3A1U2054B	1,017
20	60	Y-1R3A1U2060B	1,080
20	66	Y-1R3A1U2066B	1,141
20	72	Y-1R3A1U2072B	1,204
20	78	Y-1R3A1U2078B	1,267
20	84	Y-1R3A1U2084B	1,329

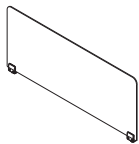

24 - 48 Wide

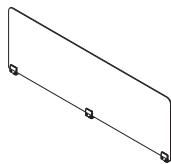

54 - 66 Wide

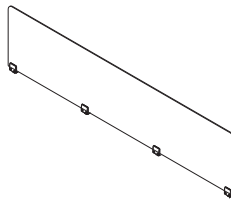

72 - 84 Wide

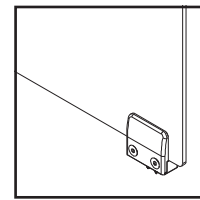

Surface Mount Clip

Specify

Notes

- Clips available in Metallic Silver only.
- Lexan available only in clear.

Lexan Nominal = Actual Size Front/Rear Surface Mount Clip Screens

Material	Where Used	Screen Type	Sized For	Mount Type
Lexan 1/4"	Front/Rear on Worksurface	Clip	Nominal = Actual Size	Surface Mount

LEXAN 1/4" NOMINAL = ACTUAL SIZE FRONT/REAR SURFACE MOUNT CLIP SCREENS WITH CUT-OUTS

H	W	Model Number	List
12	24	Y-1R3A1U1224A	605
12	30	Y-1R3A1U1230A	642
12	36	Y-1R3A1U1236A	679
12	42	Y-1R3A1U1242A	717
12	48	Y-1R3A1U1248A	755
12	54	Y-1R3A1U1254A	791
12	60	Y-1R3A1U1260A	829
12	66	Y-1R3A1U1266A	867
12	72	Y-1R3A1U1272A	903
12	78	Y-1R3A1U1278A	939
12	84	Y-1R3A1U1284A	976
16	24	Y-1R3A1U1624A	655
16	30	Y-1R3A1U1630A	704
16	36	Y-1R3A1U1636A	755
16	42	Y-1R3A1U1642A	804
16	48	Y-1R3A1U1648A	855
16	54	Y-1R3A1U1654A	903
16	60	Y-1R3A1U1660A	954
16	66	Y-1R3A1U1666A	1,002
16	72	Y-1R3A1U1672A	1,052
16	78	Y-1R3A1U1678A	1,102
16	84	Y-1R3A1U1684A	1,154

LEXAN 1/4" NOMINAL = ACTUAL SIZE FRONT/REAR SURFACE MOUNT CLIP SCREENS WITH CUT-OUTS

H	W	Model Number	List
20	24	Y-1R3A1U2024A	704
20	30	Y-1R3A1U2030A	766
20	36	Y-1R3A1U2036A	829
20	42	Y-1R3A1U2042A	890
20	48	Y-1R3A1U2048A	954
20	54	Y-1R3A1U2054A	1,017
20	60	Y-1R3A1U2060A	1,080
20	66	Y-1R3A1U2066A	1,141
20	72	Y-1R3A1U2072A	1,204
20	78	Y-1R3A1U2078A	1,267
20	84	Y-1R3A1U2084A	1,329

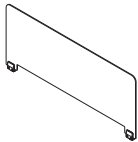

24 - 54 Wide

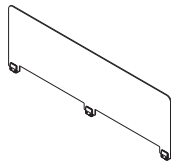

60 - 72 Wide

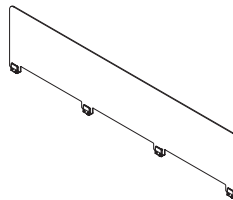

78 - 84 Wide

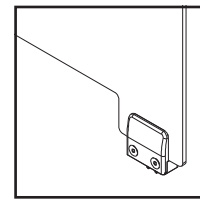

Surface Mount Clip

Specify

Notes

- Clips available in Metallic Silver only.
- Lexan available only in clear.

Glass Nominal = Actual Size Front/Rear Surface Mount Clip Screens

Material	Where Used	Screen Type	Sized For	Mount Type
Glass 1/4"	Front/Rear on Worksurface	Clip	Nominal = Actual Size	Surface Mount

GLASS 1/4" NOMINAL = ACTUAL SIZE FRONT/REAR SURFACE MOUNT CLIP SCREENS

H	W	Model Number	List	Tinted Glass	Frosted Glass
12	24	Y-3R3A1U1224B	535	+30	+110
12	30	Y-3R3A1U1230B	542	+38	+138
12	36	Y-3R3A1U1236B	549	+45	+165
12	42	Y-3R3A1U1242B	578	+53	+193
12	48	Y-3R3A1U1248B	607	+60	+220
12	54	Y-3R3A1U1254B	727	+68	+248
12	60	Y-3R3A1U1260B	666	+75	+275
12	66	Y-3R3A1U1266B	695	+83	+303
12	72	Y-3R3A1U1272B	724	+90	+330
12	78	Y-3R3A1U1278B	753	+98	+358
12	84	Y-3R3A1U1284B	779	+105	+385
16	24	Y-3R3A1U1624B	661	+40	+147
16	30	Y-3R3A1U1630B	687	+50	+184
16	36	Y-3R3A1U1636B	727	+60	+220
16	42	Y-3R3A1U1642B	756	+70	+257
16	48	Y-3R3A1U1648B	789	+80	+294
16	54	Y-3R3A1U1654B	840	+90	+330
16	60	Y-3R3A1U1660B	887	+100	+367
16	66	Y-3R3A1U1666B	899	+110	+404
16	72	Y-3R3A1U1672B	920	+120	+440
16	78	Y-3R3A1U1678B	937	+130	+477
16	84	Y-3R3A1U1684B	954	+140	+514

GLASS 1/4" NOMINAL = ACTUAL SIZE FRONT/REAR SURFACE MOUNT CLIP SCREENS

H	W	Model Number	List	Tinted Glass	Frosted Glass
20	24	Y-3R3A1U2024B	606	+50	+184
20	30	Y-3R3A1U2030B	659	+63	+230
20	36	Y-3R3A1U2036B	695	+75	+275
20	42	Y-3R3A1U2042B	765	+88	+321
20	48	Y-3R3A1U2048B	816	+100	+367
20	54	Y-3R3A1U2054B	869	+113	+413
20	60	Y-3R3A1U2060B	922	+125	+459
20	66	Y-3R3A1U2066B	975	+138	+505
20	72	Y-3R3A1U2072B	1,028	+150	+550
20	78	Y-3R3A1U2078B	1,082	+163	+596
20	84	Y-3R3A1U2084B	1,133	+175	+642
24	24	Y-3R3A1U2424B	647	+60	+220
24	30	Y-3R3A1U2430B	710	+75	+275
24	36	Y-3R3A1U2436B	773	+90	+330
24	42	Y-3R3A1U2442B	834	+105	+385
24	48	Y-3R3A1U2448B	897	+120	+440
24	54	Y-3R3A1U2454B	958	+135	+495
24	60	Y-3R3A1U2460B	1,021	+150	+550
24	66	Y-3R3A1U2466B	1,085	+165	+605
24	72	Y-3R3A1U2472B	1,145	+180	+660
24	78	Y-3R3A1U2478B	1,206	+195	+715
24	84	Y-3R3A1U2484B	1,267	+210	+770

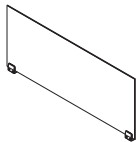

24 - 54 Wide

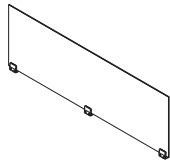

60 - 72 Wide

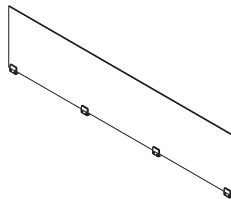

78 - 84 Wide

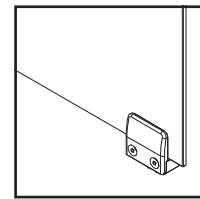

Surface Mount Clip

Specify

Notes

- Clips available in Metallic Silver only.
- Standard products for glass are always clear unless noted otherwise, other colors may be available upon special request (upcharges apply).

Glass Nominal = Actual Size Front/Rear Surface Mount Clip Screens

Material	Where Used	Screen Type	Sized For	Mount Type
Glass 3/8"	Front/Rear on Worksurface	Clip	Nominal = Actual Size	Surface Mount

**GLASS 3/8" NOMINAL = ACTUAL SIZE
FRONT/REAR SURFACE MOUNT CLIP SCREENS**

H	W	Model Number	List	Tinted Glass	Frosted Glass
12	24	Y-4R3A1U1224B	718	+30	+60
12	30	Y-4R3A1U1230B	722	+38	+75
12	36	Y-4R3A1U1236B	786	+45	+90
12	42	Y-4R3A1U1242B	848	+53	+105
12	48	Y-4R3A1U1248B	914	+60	+120
12	54	Y-4R3A1U1254B	979	+68	+135
12	60	Y-4R3A1U1260B	1,045	+75	+150
12	66	Y-4R3A1U1266B	1,109	+83	+165
12	72	Y-4R3A1U1272B	1,173	+90	+180
12	78	Y-4R3A1U1278B	1,239	+98	+195
12	84	Y-4R3A1U1284B	1,304	+105	+210
16	24	Y-4R3A1U1624B	684	+40	+80
16	30	Y-4R3A1U1630B	764	+50	+100
16	36	Y-4R3A1U1636B	801	+60	+120
16	42	Y-4R3A1U1642B	891	+70	+140
16	48	Y-4R3A1U1648B	988	+80	+160
16	54	Y-4R3A1U1654B	1,056	+90	+180
16	60	Y-4R3A1U1660B	1,087	+100	+200
16	66	Y-4R3A1U1666B	1,184	+110	+220
16	72	Y-4R3A1U1672B	1,258	+120	+240
16	78	Y-4R3A1U1678B	1,280	+130	+260
16	84	Y-4R3A1U1684B	1,344	+140	+280

**GLASS 3/8" NOMINAL = ACTUAL SIZE
FRONT/REAR SURFACE MOUNT CLIP SCREENS**

H	W	Model Number	List	Tinted Glass	Frosted Glass
20	24	Y-4R3A1U2024B	780	+50	+100
20	30	Y-4R3A1U2030B	884	+63	+125
20	36	Y-4R3A1U2036B	984	+75	+150
20	42	Y-4R3A1U2042B	1,086	+88	+175
20	48	Y-4R3A1U2048B	1,184	+100	+200
20	54	Y-4R3A1U2054B	1,287	+113	+225
20	60	Y-4R3A1U2060B	1,387	+125	+250
20	66	Y-4R3A1U2066B	1,489	+138	+275
20	72	Y-4R3A1U2072B	1,587	+150	+300
20	78	Y-4R3A1U2078B	1,687	+163	+325
20	84	Y-4R3A1U2084B	1,788	+175	+350
24	24	Y-4R3A1U2424B	855	+60	+120
24	30	Y-4R3A1U2430B	975	+75	+150
24	36	Y-4R3A1U2436B	1,093	+90	+180
24	42	Y-4R3A1U2442B	1,212	+105	+210
24	48	Y-4R3A1U2448B	1,331	+120	+240
24	54	Y-4R3A1U2454B	1,450	+135	+270
24	60	Y-4R3A1U2460B	1,571	+150	+300
24	66	Y-4R3A1U2466B	1,690	+165	+330
24	72	Y-4R3A1U2472B	1,807	+180	+360
24	78	Y-4R3A1U2478B	1,925	+195	+390
24	84	Y-4R3A1U2484B	2,044	+210	+420

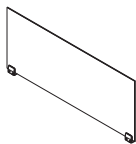

24 - 54 Wide

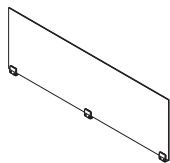

60 - 72 Wide

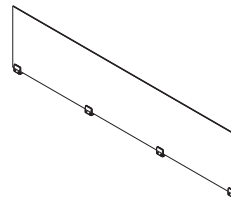

78 - 84 Wide

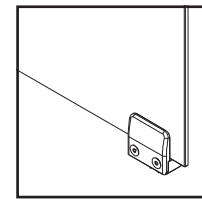

Surface Mount Clip

Specify

Notes

- Clips available in Metallic Silver only.
- Standard products for glass are always clear unless noted otherwise, other colors may be available upon special request (upcharges apply).

Lexan Nominal = Actual Size Front/Rear Under Surface Mount Clip Screens

Material	Where Used	Screen Type	Sized For	Mount Type
Lexan 1/4"	Front/Rear on Worksurface	Clip	Nominal = Actual Size	Under Surface Mount

LEXAN 1/4" NOMINAL = ACTUAL SIZE FRONT/REAR UNDER SURFACE MOUNT CLIP SCREENS WITHOUT CUT-OUTS

H	W	Model Number	List
12	24	Y-1R3A2U1224B	605
12	30	Y-1R3A2U1230B	642
12	36	Y-1R3A2U1236B	679
12	42	Y-1R3A2U1242B	717
12	48	Y-1R3A2U1248B	755
12	54	Y-1R3A2U1254B	791
12	60	Y-1R3A2U1260B	829
12	66	Y-1R3A2U1266B	867
12	72	Y-1R3A2U1272B	903
12	78	Y-1R3A2U1278B	939
12	84	Y-1R3A2U1284B	976
16	24	Y-1R3A2U1624B	655
16	30	Y-1R3A2U1630B	704
16	36	Y-1R3A2U1636B	755
16	42	Y-1R3A2U1642B	804
16	48	Y-1R3A2U1648B	855
16	54	Y-1R3A2U1654B	903
16	60	Y-1R3A2U1660B	954
16	66	Y-1R3A2U1666B	1,002
16	72	Y-1R3A2U1672B	1,052
16	78	Y-1R3A2U1678B	1,102
16	84	Y-1R3A2U1684B	1,154

LEXAN 1/4" NOMINAL = ACTUAL SIZE FRONT/REAR UNDER SURFACE MOUNT CLIP SCREENS WITHOUT CUT-OUTS

H	W	Model Number	List
20	24	Y-1R3A2U2024B	704
20	30	Y-1R3A2U2030B	766
20	36	Y-1R3A2U2036B	829
20	42	Y-1R3A2U2042B	890
20	48	Y-1R3A2U2048B	954
20	54	Y-1R3A2U2054B	1,017
20	60	Y-1R3A2U2060B	1,080
20	66	Y-1R3A2U2066B	1,141
20	72	Y-1R3A2U2072B	1,204
20	78	Y-1R3A2U2078B	1,267
20	84	Y-1R3A2U2084B	1,329

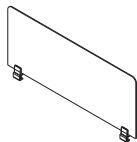

24 - 54 Wide

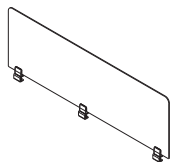

60 - 72 Wide

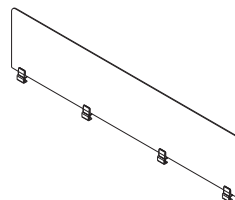

78 - 84 Wide

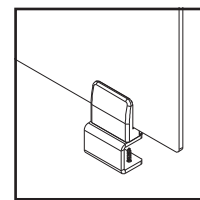

Under Surface Mount Clip

Specify

Notes

- Clips available in Metallic Silver only.
- Lexan available only in clear.

Lexan Nominal = Actual Size Front/Rear Under Surface Mount Clip Screens

Material	Where Used	Screen Type	Sized For	Mount Type
Lexan 1/4"	Front/Rear on Worksurface	Clip	Nominal = Actual Size	Under Surface Mount

LEXAN 1/4" NOMINAL = ACTUAL SIZE FRONT/REAR UNDER SURFACE MOUNT CLIP SCREENS WITH CUT-OUTS

H	W	Model Number	List
12	24	Y-1R3A2U1224A	605
12	30	Y-1R3A2U1230A	642
12	36	Y-1R3A2U1236A	679
12	42	Y-1R3A2U1242A	717
12	48	Y-1R3A2U1248A	755
12	54	Y-1R3A2U1254A	791
12	60	Y-1R3A2U1260A	829
12	66	Y-1R3A2U1266A	867
12	72	Y-1R3A2U1272A	903
12	78	Y-1R3A2U1278A	939
12	84	Y-1R3A2U1284A	976
16	24	Y-1R3A2U1624A	655
16	30	Y-1R3A2U1630A	704
16	36	Y-1R3A2U1636A	755
16	42	Y-1R3A2U1642A	804
16	48	Y-1R3A2U1648A	855
16	54	Y-1R3A2U1654A	903
16	60	Y-1R3A2U1660A	954
16	66	Y-1R3A2U1666A	1,002
16	72	Y-1R3A2U1672A	1,052
16	78	Y-1R3A2U1678A	1,102
16	84	Y-1R3A2U1684A	1,154

LEXAN 1/4" NOMINAL = ACTUAL SIZE FRONT/REAR UNDER SURFACE MOUNT CLIP SCREENS WITH CUT-OUTS

H	W	Model Number	List
20	24	Y-1R3A2U2024A	704
20	30	Y-1R3A2U2030A	766
20	36	Y-1R3A2U2036A	829
20	42	Y-1R3A2U2042A	890
20	48	Y-1R3A2U2048A	954
20	54	Y-1R3A2U2054A	1,017
20	60	Y-1R3A2U2060A	1,080
20	66	Y-1R3A2U2066A	1,141
20	72	Y-1R3A2U2072A	1,204
20	78	Y-1R3A2U2078A	1,267
20	84	Y-1R3A2U2084A	1,329

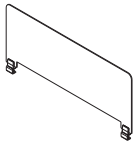

24 - 54 Wide

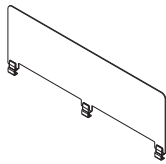

60 - 72 Wide

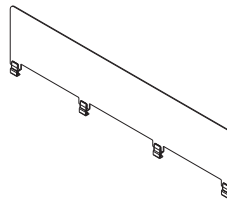

78 - 84 Wide

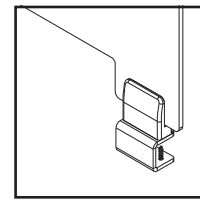

Under Surface Mount Clip

Specify

Notes

- Clips available in Metallic Silver only.
- Lexan available only in clear.

Glass Nominal = Actual Size Front/Rear Under Surface Mount Clip Screens

Material	Where Used	Screen Type	Sized For	Mount Type
Glass 1/4"	Front/Rear on Worksurface	Clip	Nominal = Actual Size	Under Surface Mount

GLASS 1/4" NOMINAL = ACTUAL SIZE FRONT/REAR UNDER SURFACE MOUNT CLIP SCREENS

H	W	Model Number	List	Tinted Glass	Frosted Glass
12	24	Y-3R3A2U1224B	535	+30	+110
12	30	Y-3R3A2U1230B	542	+38	+138
12	36	Y-3R3A2U1236B	549	+45	+165
12	42	Y-3R3A2U1242B	578	+53	+193
12	48	Y-3R3A2U1248B	607	+60	+220
12	54	Y-3R3A2U1254B	727	+68	+248
12	60	Y-3R3A2U1260B	666	+75	+275
12	66	Y-3R3A2U1266B	695	+83	+303
12	72	Y-3R3A2U1272B	724	+90	+330
12	78	Y-3R3A2U1278B	753	+98	+358
12	84	Y-3R3A2U1284B	779	+105	+385
16	24	Y-3R3A2U1624B	661	+40	+147
16	30	Y-3R3A2U1630B	687	+50	+184
16	36	Y-3R3A2U1636B	727	+60	+220
16	42	Y-3R3A2U1642B	756	+70	+257
16	48	Y-3R3A2U1648B	789	+80	+294
16	54	Y-3R3A2U1654B	840	+90	+330
16	60	Y-3R3A2U1660B	887	+100	+367
16	66	Y-3R3A2U1666B	899	+110	+404
16	72	Y-3R3A2U1672B	920	+120	+440
16	78	Y-3R3A2U1678B	937	+130	+477
16	84	Y-3R3A2U1684B	954	+140	+514

GLASS 1/4" NOMINAL = ACTUAL SIZE FRONT/REAR UNDER SURFACE MOUNT CLIP SCREENS

H	W	Model Number	List	Tinted Glass	Frosted Glass
20	24	Y-3R3A2U2024B	606	+50	+184
20	30	Y-3R3A2U2030B	659	+63	+230
20	36	Y-3R3A2U2036B	695	+75	+275
20	42	Y-3R3A2U2042B	765	+88	+321
20	48	Y-3R3A2U2048B	816	+100	+367
20	54	Y-3R3A2U2054B	869	+113	+413
20	60	Y-3R3A2U2060B	922	+125	+459
20	66	Y-3R3A2U2066B	975	+138	+505
20	72	Y-3R3A2U2072B	1,028	+150	+550
20	78	Y-3R3A2U2078B	1,082	+163	+596
20	84	Y-3R3A2U2084B	1,133	+175	+642
24	24	Y-3R3A2U2424B	647	+60	+220
24	30	Y-3R3A2U2430B	710	+75	+275
24	36	Y-3R3A2U2436B	773	+90	+330
24	42	Y-3R3A2U2442B	834	+105	+385
24	48	Y-3R3A2U2448B	897	+120	+440
24	54	Y-3R3A2U2454B	958	+135	+495
24	60	Y-3R3A2U2460B	1,021	+150	+550
24	66	Y-3R3A2U2466B	1,085	+165	+605
24	72	Y-3R3A2U2472B	1,145	+180	+660
24	78	Y-3R3A2U2478B	1,206	+195	+715
24	84	Y-3R3A2U2484B	1,267	+210	+770

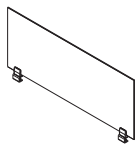

24 - 54 Wide

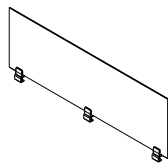

60 - 72 Wide

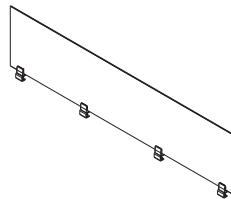

78 - 84 Wide

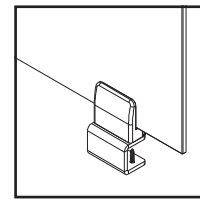

Under Surface Mount Clip

Specify

Notes

- Clips available in Metallic Silver only.
- Standard products for glass are always clear unless noted otherwise, other colors may be available upon special request (upcharges apply).

Glass Nominal = Actual Size Front/Rear Under Surface Mount Clip Screens

Material	Where Used	Screen Type	Sized For	Mount Type
Glass 1/4"	Front/Rear on Worksurface	Clip	Nominal = Actual Size	Under Surface Mount

**GLASS 3/8" NOMINAL = ACTUAL SIZE
FRONT/REAR UNDER SURFACE MOUNT CLIP SCREENS**

H	W	Model Number	List	Tinted Glass	Frosted Glass
12	24	Y-4R3A2U1224B	718	+30	+60
12	30	Y-4R3A2U1230B	722	+38	+75
12	36	Y-4R3A2U1236B	786	+45	+90
12	42	Y-4R3A2U1242B	848	+53	+105
12	48	Y-4R3A2U1248B	914	+60	+120
12	54	Y-4R3A2U1254B	979	+68	+135
12	60	Y-4R3A2U1260B	1,045	+75	+150
12	66	Y-4R3A2U1266B	1,109	+83	+165
12	72	Y-4R3A2U1272B	1,173	+90	+180
12	78	Y-4R3A2U1278B	1,239	+98	+195
12	84	Y-4R3A2U1284B	1,304	+105	+210
16	24	Y-4R3A2U1624B	684	+40	+80
16	30	Y-4R3A2U1630B	764	+50	+100
16	36	Y-4R3A2U1636B	801	+60	+120
16	42	Y-4R3A2U1642B	891	+70	+140
16	48	Y-4R3A2U1648B	988	+80	+160
16	54	Y-4R3A2U1654B	1,056	+90	+180
16	60	Y-4R3A2U1660B	1,087	+100	+200
16	66	Y-4R3A2U1666B	1,184	+110	+220
16	72	Y-4R3A2U1672B	1,258	+120	+240
16	78	Y-4R3A2U1678B	1,280	+130	+260
16	84	Y-4R3A2U1684B	1,344	+140	+280

**GLASS 3/8" NOMINAL = ACTUAL SIZE
FRONT/REAR UNDER SURFACE MOUNT CLIP SCREENS**

H	W	Model Number	List	Tinted Glass	Frosted Glass
20	24	Y-4R3A2U2024B	780	+50	+100
20	30	Y-4R3A2U2030B	884	+63	+125
20	36	Y-4R3A2U2036B	984	+75	+150
20	42	Y-4R3A2U2042B	1,086	+88	+175
20	48	Y-4R3A2U2048B	1,184	+100	+200
20	54	Y-4R3A2U2054B	1,287	+113	+225
20	60	Y-4R3A2U2060B	1,387	+125	+250
20	66	Y-4R3A2U2066B	1,489	+138	+275
20	72	Y-4R3A2U2072B	1,587	+150	+300
20	78	Y-4R3A2U2078B	1,687	+163	+325
20	84	Y-4R3A2U2084B	1,788	+175	+350
24	24	Y-4R3A2U2424B	855	+60	+120
24	30	Y-4R3A2U2430B	975	+75	+150
24	36	Y-4R3A2U2436B	1,093	+90	+180
24	42	Y-4R3A2U2442B	1,212	+105	+210
24	48	Y-4R3A2U2448B	1,331	+120	+240
24	54	Y-4R3A2U2454B	1,450	+135	+270
24	60	Y-4R3A2U2460B	1,571	+150	+300
24	66	Y-4R3A2U2466B	1,690	+165	+330
24	72	Y-4R3A2U2472B	1,807	+180	+360
24	78	Y-4R3A2U2478B	1,925	+195	+390
24	84	Y-4R3A2U2484B	2,044	+210	+420

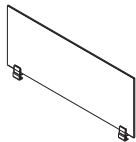

24 - 54 Wide

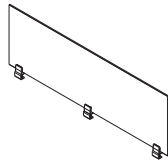

60 - 72 Wide

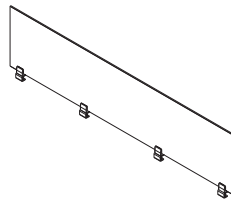

78 - 84 Wide

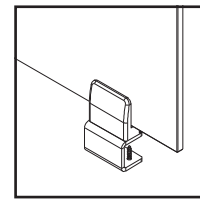

Under Surface Mount Clip

Specify

Notes

- Clips available in Metallic Silver only.
- Standard products for glass are always clear unless noted otherwise, other colors may be available upon special request (upcharges apply).

Lexan Nominal = Actual Size Freestanding Clip Screens

Material	Where Used	Screen Type	Sized For	Mount Type
Lexan 1/4"	Front/Rear on Worksurface	Clip	Nominal = Actual Size	Freestanding

**LEXAN 1/4" NOMINAL = ACTUAL SIZE
FRONT/REAR FREESTANDING CLIP SCREENS WITHOUT CUT-OUTS**

H	W	Model Number	List
12	24	Y-1R3A4U1224B	735
12	30	Y-1R3A4U1230B	771
12	36	Y-1R3A4U1236B	808
12	42	Y-1R3A4U1242B	846
12	48	Y-1R3A4U1248B	885
12	54	Y-1R3A4U1254B	921
12	60	Y-1R3A4U1260B	1,024
12	66	Y-1R3A4U1266B	1,061
12	72	Y-1R3A4U1272B	1,098
12	78	Y-1R3A4U1278B	1,199
12	84	Y-1R3A4U1284B	1,236
16	24	Y-1R3A4U1624B	786
16	30	Y-1R3A4U1630B	834
16	36	Y-1R3A4U1636B	885
16	42	Y-1R3A4U1642B	935
16	48	Y-1R3A4U1648B	985
16	54	Y-1R3A4U1654B	1,032
16	60	Y-1R3A4U1660B	1,149
16	66	Y-1R3A4U1666B	1,198
16	72	Y-1R3A4U1672B	1,248
16	78	Y-1R3A4U1678B	1,362
16	84	Y-1R3A4U1684B	1,414

**LEXAN 1/4" NOMINAL = ACTUAL SIZE
FRONT/REAR FREESTANDING CLIP SCREENS WITHOUT CUT-OUTS**

H	W	Model Number	List
20	24	Y-1R3A4U2024B	834
20	30	Y-1R3A4U2030B	897
20	36	Y-1R3A4U2036B	958
20	42	Y-1R3A4U2042B	1,021
20	48	Y-1R3A4U2048B	1,085
20	54	Y-1R3A4U2054B	1,146
20	60	Y-1R3A4U2060B	1,275
20	66	Y-1R3A4U2066B	1,335
20	72	Y-1R3A4U2072B	1,399
20	78	Y-1R3A4U2078B	1,527
20	84	Y-1R3A4U2084B	1,589

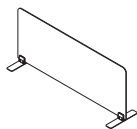

24 - 54 Wide

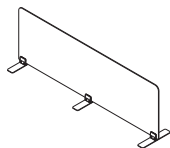

60 - 72 Wide

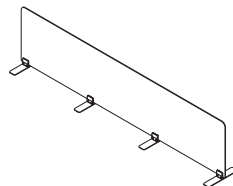

78 - 84 Wide

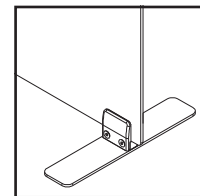

Freestanding Clip

Specify

Notes

- Clips available in Metallic Silver only.
- Lexan available only in clear.
- Non-marring feet measure 2 3/8" x 12".

Lexan Nominal = Actual Size Freestanding Clip Screens

Material	Where Used	Screen Type	Sized For	Mount Type
Lexan 1/4"	Front/Rear on Worksurface	Clip	Nominal = Actual Size	Freestanding

**LEXAN 1/4" NOMINAL = ACTUAL SIZE
FRONT/REAR FREESTANDING CLIP SCREENS WITH CUT-OUTS**

H	W	Model Number	List
12	24	Y-1R3A4U1224A	735
12	30	Y-1R3A4U1230A	771
12	36	Y-1R3A4U1236A	808
12	42	Y-1R3A4U1242A	846
12	48	Y-1R3A4U1248A	885
12	54	Y-1R3A4U1254A	921
12	60	Y-1R3A4U1260A	1,024
12	66	Y-1R3A4U1266A	1,061
12	72	Y-1R3A4U1272A	1,098
12	78	Y-1R3A4U1278A	1,199
12	84	Y-1R3A4U1284A	1,236
16	24	Y-1R3A4U1624A	786
16	30	Y-1R3A4U1630A	834
16	36	Y-1R3A4U1636A	885
16	42	Y-1R3A4U1642A	935
16	48	Y-1R3A4U1648A	985
16	54	Y-1R3A4U1654A	1,032
16	60	Y-1R3A4U1660A	1,149
16	66	Y-1R3A4U1666A	1,198
16	72	Y-1R3A4U1672A	1,248
16	78	Y-1R3A4U1678A	1,362
16	84	Y-1R3A4U1684A	1,414

**LEXAN 1/4" NOMINAL = ACTUAL SIZE
FRONT/REAR FREESTANDING CLIP SCREENS WITH CUT-OUTS**

H	W	Model Number	List
20	24	Y-1R3A4U2024A	834
20	30	Y-1R3A4U2030A	897
20	36	Y-1R3A4U2036A	958
20	42	Y-1R3A4U2042A	1,021
20	48	Y-1R3A4U2048A	1,085
20	54	Y-1R3A4U2054A	1,146
20	60	Y-1R3A4U2060A	1,275
20	66	Y-1R3A4U2066A	1,335
20	72	Y-1R3A4U2072A	1,399
20	78	Y-1R3A4U2078A	1,527
20	84	Y-1R3A4U2084A	1,589

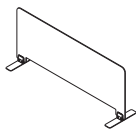

24 - 54 Wide

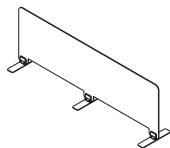

60 - 72 Wide

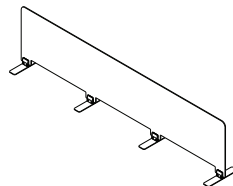

78 - 84 Wide

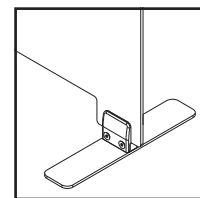

Freestanding Clip

Specify

Notes

- Clips available in Metallic Silver only.
- Lexan available only in clear.
- Non-marring feet measure 2 3/8" x 12".

Lexan Nominal = Actual Size Panel Top Surface Mount Clip Screens

Material	Where Used	Screen Type	Sized For	Mount Type
Lexan 1/4"	Panel Top	Clip	Nominal = Actual Size	Surface Mount

**LEXAN 1/4" NOMINAL = ACTUAL SIZE
PANEL TOP SURFACE MOUNT CLIP SCREENS**

H	W	Model Number	List
12	24	Y-1P3A1U1224B	605
12	30	Y-1P3A1U1230B	642
12	36	Y-1P3A1U1236B	679
12	42	Y-1P3A1U1242B	717
12	48	Y-1P3A1U1248B	755
12	54	Y-1P3A1U1254B	791
12	60	Y-1P3A1U1260B	829
12	66	Y-1P3A1U1266B	867
12	72	Y-1P3A1U1272B	903
12	78	Y-1P3A1U1278B	939
12	84	Y-1P3A1U1284B	976
16	24	Y-1P3A1U1624B	655
16	30	Y-1P3A1U1630B	704
16	36	Y-1P3A1U1636B	755
16	42	Y-1P3A1U1642B	804
16	48	Y-1P3A1U1648B	855
16	54	Y-1P3A1U1654B	903
16	60	Y-1P3A1U1660B	954
16	66	Y-1P3A1U1666B	1,002
16	72	Y-1P3A1U1672B	1,052
16	78	Y-1P3A1U1678B	1,102
16	84	Y-1P3A1U1684B	1,154

**LEXAN 1/4" NOMINAL = ACTUAL SIZE
PANEL TOP SURFACE MOUNT CLIP SCREENS**

H	W	Model Number	List
20	24	Y-1P3A1U2024B	704
20	30	Y-1P3A1U2030B	766
20	36	Y-1P3A1U2036B	829
20	42	Y-1P3A1U2042B	890
20	48	Y-1P3A1U2048B	954
20	54	Y-1P3A1U2054B	1,017
20	60	Y-1P3A1U2060B	1,080
20	66	Y-1P3A1U2066B	1,141
20	72	Y-1P3A1U2072B	1,204
20	78	Y-1P3A1U2078B	1,267
20	84	Y-1P3A1U2084B	1,329

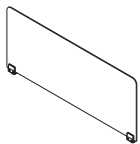

24 - 48 Wide

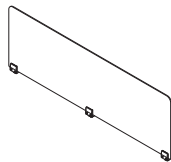

54 - 66 Wide

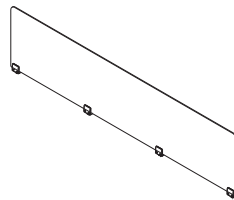

72 - 84 Wide

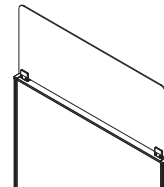

On Panel Top

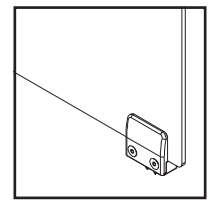

Surface Mount Clip

Specify

• Paint Selection

Notes

- Can not be used on Matrix or Divi. For Matrix see Matrix price list, for Divi see section in Screens price list.
- Clips available in Metallic Silver only.
- Lexan available only in clear.

Glass Nominal = Actual Size Panel Top Surface Mount Clip Screens

Material	Where Used	Screen Type	Sized For	Mount Type
Glass 1/4"	Panel Top	Clip	Nominal = Actual Size	Surface Mount

**GLASS 1/4" NOMINAL = ACTUAL SIZE
PANEL TOP SURFACE MOUNT CLIP SCREENS**

H	W	Model Number	List	Tinted Glass	Frosted Glass
8	24	Y-3P3A1U0824B	432	30	110
8	30	Y-3P3A1U0830B	463	38	138
8	36	Y-3P3A1U0836B	493	45	165
8	42	Y-3P3A1U0842B	523	53	193
8	48	Y-3P3A1U0848B	553	60	220
8	54	Y-3P3A1U0854B	584	68	248
8	60	Y-3P3A1U0860B	614	75	275
8	66	Y-3P3A1U0866B	644	83	303
8	72	Y-3P3A1U0872B	674	90	330
8	78	Y-3P3A1U0878B	705	98	358
8	84	Y-3P3A1U0884B	735	105	385
12	24	Y-3P3A1U1224B	535	+30	+110
12	30	Y-3P3A1U1230B	542	+38	+138
12	36	Y-3P3A1U1236B	549	+45	+165
12	42	Y-3P3A1U1242B	578	+53	+193
12	48	Y-3P3A1U1248B	607	+60	+220
12	54	Y-3P3A1U1254B	637	+68	+248
12	60	Y-3P3A1U1260B	666	+75	+275
12	66	Y-3P3A1U1266B	695	+83	+303
12	72	Y-3P3A1U1272B	724	+90	+330
12	78	Y-3P3A1U1278B	753	+98	+358
12	84	Y-3P3A1U1284B	779	+105	+385

**GLASS 1/4" NOMINAL = ACTUAL SIZE
PANEL TOP SURFACE MOUNT CLIP SCREENS**

H	W	Model Number	List	Tinted Glass	Frosted Glass
16	24	Y-3P3A1U1624B	661	+40	+147
16	30	Y-3P3A1U1630B	687	+50	+184
16	36	Y-3P3A1U1636B	727	+60	+220
16	42	Y-3P3A1U1642B	756	+70	+257
16	48	Y-3P3A1U1648B	789	+80	+294
16	54	Y-3P3A1U1654B	840	+90	+330
16	60	Y-3P3A1U1660B	887	+100	+367
16	66	Y-3P3A1U1666B	899	+110	+404
16	72	Y-3P3A1U1672B	920	+120	+440
16	78	Y-3P3A1U1678B	937	+130	+477
16	84	Y-3P3A1U1684B	954	+140	+514

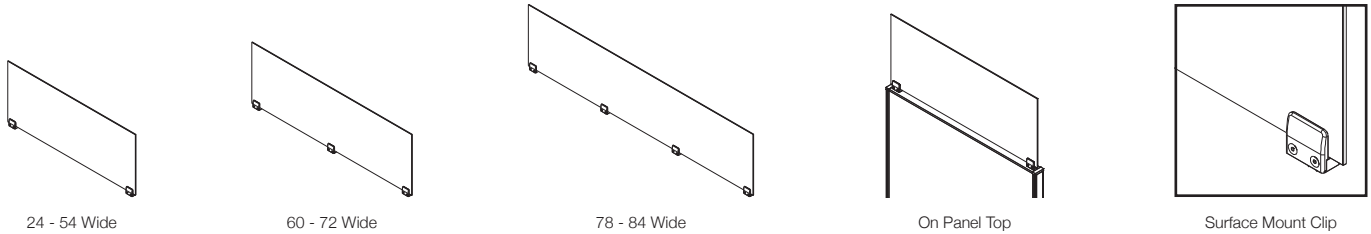

Specify

• Paint Selection

Notes

- Can not be used on Matrix or Divi. For Matrix see Matrix price list, for Divi see section in Screens price list.
- Clips available in Metallic Silver only.
- Standard products for glass are always clear unless noted otherwise, other colors may be available upon special request (upcharges apply).

Glass Nominal = Actual Size Panel Top Surface Mount Clip Screens

Material	Where Used	Screen Type	Sized For	Mount Type
Glass 1/4"	Panel Top	Clip	Nominal = Actual Size	Surface Mount

**GLASS 1/4" NOMINAL = ACTUAL SIZE
PANEL TOP SURFACE MOUNT CLIP SCREENS**

H	W	Model Number	List	Tinted Glass	Frosted Glass
20	24	Y-3P3A1U2024B	606	+50	+184
20	30	Y-3P3A1U2030B	659	+63	+230
20	36	Y-3P3A1U2036B	695	+75	+275
20	42	Y-3P3A1U2042B	765	+88	+321
20	48	Y-3P3A1U2048B	816	+100	+367
20	54	Y-3P3A1U2054B	869	+113	+413
20	60	Y-3P3A1U2060B	922	+125	+459
20	66	Y-3P3A1U2066B	975	+138	+505
20	72	Y-3P3A1U2072B	1,028	+150	+550
20	78	Y-3P3A1U2078B	1,082	+163	+596
20	84	Y-3P3A1U2084B	1,133	+175	+642

**GLASS 1/4" NOMINAL = ACTUAL SIZE
PANEL TOP SURFACE MOUNT CLIP SCREENS**

H	W	Model Number	List	Tinted Glass	Frosted Glass
24	24	Y-3P3A1U2424B	647	+60	+220
24	30	Y-3P3A1U2430B	710	+75	+275
24	36	Y-3P3A1U2436B	773	+90	+330
24	42	Y-3P3A1U2442B	834	+105	+385
24	48	Y-3P3A1U2448B	897	+120	+440
24	54	Y-3P3A1U2454B	958	+135	+495
24	60	Y-3P3A1U2460B	1,021	+150	+550
24	66	Y-3P3A1U2466B	1,085	+165	+605
24	72	Y-3P3A1U2472B	1,145	+180	+660
24	78	Y-3P3A1U2478B	1,206	+195	+715
24	84	Y-3P3A1U2484B	1,267	+210	+770

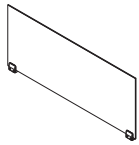

24 - 54 Wide

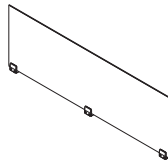

60 - 72 Wide

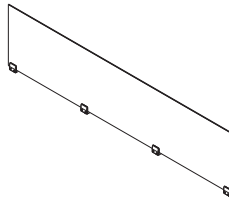

78 - 84 Wide

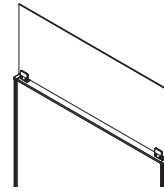

On Panel Top

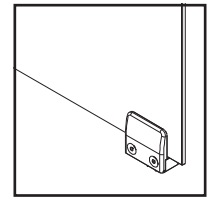

Surface Mount Clip

Specify

- Paint Selection

Notes

- Can not be used on Matrix or Divi. For Matrix see Matrix price list, for Divi see section in Screens price list.
- Clips available in Metallic Silver only.
- Standard products for glass are always clear unless noted otherwise, other colors may be available upon special request (upcharges apply).

Glass Nominal = Actual Size Panel Top Surface Mount Clip Screens

Material	Where Used	Screen Type	Sized For	Mount Type
Glass 1/4"	Panel Top	Clip	Nominal = Actual Size	Surface Mount

**GLASS 3/8" NOMINAL = ACTUAL SIZE
PANEL TOP SURFACE MOUNT CLIP SCREENS**

H	W	Model Number	List	Tinted Glass	Frosted Glass
8	24	Y-4P3A1U0824B	648	30	60
8	30	Y-4P3A1U0830B	702	38	75
8	36	Y-4P3A1U0836B	756	45	90
8	42	Y-4P3A1U0842B	810	53	105
8	48	Y-4P3A1U0848B	864	60	120
8	54	Y-4P3A1U0854B	918	68	135
8	60	Y-4P3A1U0860B	972	75	150
8	66	Y-4P3A1U0866B	1,026	83	165
8	72	Y-4P3A1U0872B	1,080	90	180
8	78	Y-4P3A1U0878B	1,134	98	195
8	84	Y-4P3A1U0884B	1,188	105	210
12	24	Y-4P3A1U1224B	718	+30	+60
12	30	Y-4P3A1U1230B	722	+38	+75
12	36	Y-4P3A1U1236B	786	+45	+90
12	42	Y-4P3A1U1242B	848	+53	+105
12	48	Y-4P3A1U1248B	914	+60	+120
12	54	Y-4P3A1U1254B	979	+68	+135
12	60	Y-4P3A1U1260B	1,045	+75	+150
12	66	Y-4P3A1U1266B	1,109	+83	+165
12	72	Y-4P3A1U1272B	1,173	+90	+180
12	78	Y-4P3A1U1278B	1,239	+98	+195
12	84	Y-4P3A1U1284B	1,304	+105	+210

**GLASS 3/8" NOMINAL = ACTUAL SIZE
PANEL TOP SURFACE MOUNT CLIP SCREENS**

H	W	Model Number	List	Tinted Glass	Frosted Glass
16	24	Y-4P3A1U1624B	684	+40	+80
16	30	Y-4P3A1U1630B	764	+50	+100
16	36	Y-4P3A1U1636B	801	+60	+120
16	42	Y-4P3A1U1642B	891	+70	+140
16	48	Y-4P3A1U1648B	988	+80	+160
16	54	Y-4P3A1U1654B	1,056	+90	+180
16	60	Y-4P3A1U1660B	1,087	+100	+200
16	66	Y-4P3A1U1666B	1,184	+110	+220
16	72	Y-4P3A1U1672B	1,258	+120	+240
16	78	Y-4P3A1U1678B	1,280	+130	+260
16	84	Y-4P3A1U1684B	1,344	+140	+280

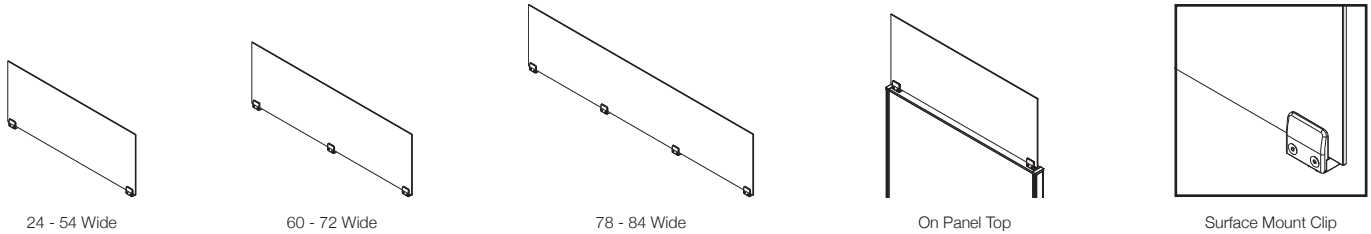

Specify	Notes
• Paint Selection	• Can not be used on Matrix or Divi. For Matrix see Matrix price list, for Divi see section in Screens price list.
	• Clips available in Metallic Silver only.
	• Standard products for glass are always clear unless noted otherwise, other colors may be available upon special request (upcharges apply).

Glass Nominal = Actual Size Panel Top Surface Mount Clip Screens

Material	Where Used	Screen Type	Sized For	Mount Type
Glass 1/4"	Panel Top	Clip	Nominal = Actual Size	Surface Mount

GLASS 3/8" NOMINAL = ACTUAL SIZE PANEL TOP SURFACE MOUNT CLIP SCREENS

H	W	Model Number	List	Tinted Glass	Frosted Glass
20	24	Y-4P3A1U2024B	780	+50	+100
20	30	Y-4P3A1U2030B	884	+63	+125
20	36	Y-4P3A1U2036B	984	+75	+150
20	42	Y-4P3A1U2042B	1,086	+88	+175
20	48	Y-4P3A1U2048B	1,184	+100	+200
20	54	Y-4P3A1U2054B	1,287	+113	+225
20	60	Y-4P3A1U2060B	1,387	+125	+250
20	66	Y-4P3A1U2066B	1,489	+138	+275
20	72	Y-4P3A1U2072B	1,587	+150	+300
20	78	Y-4P3A1U2078B	1,687	+163	+325
20	84	Y-4P3A1U2084B	1,788	+175	+350

GLASS 3/8" NOMINAL = ACTUAL SIZE PANEL TOP SURFACE MOUNT CLIP SCREENS

H	W	Model Number	List	Tinted Glass	Frosted Glass
24	24	Y-4P3A1U2424B	855	+60	+120
24	30	Y-4P3A1U2430B	975	+75	+150
24	36	Y-4P3A1U2436B	1,093	+90	+180
24	42	Y-4P3A1U2442B	1,212	+105	+210
24	48	Y-4P3A1U2448B	1,331	+120	+240
24	54	Y-4P3A1U2454B	1,450	+135	+270
24	60	Y-4P3A1U2460B	1,571	+150	+300
24	66	Y-4P3A1U2466B	1,690	+165	+330
24	72	Y-4P3A1U2472B	1,807	+180	+360
24	78	Y-4P3A1U2478B	1,925	+195	+390
24	84	Y-4P3A1U2484B	2,044	+210	+420

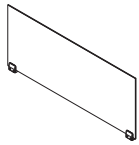

24 - 54 Wide

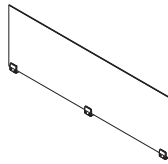

60 - 72 Wide

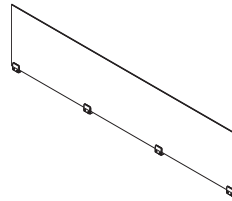

78 - 84 Wide

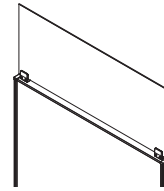

On Panel Top

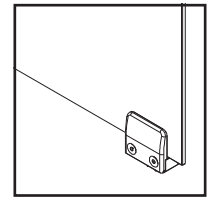

Surface Mount Clip

Specify

- Paint Selection

Notes

- Can not be used on Matrix or Divi. For Matrix see Matrix price list, for Divi see section in Screens price list.
- Clips available in Metallic Silver only.
- Standard products for glass are always clear unless noted otherwise, other colors may be available upon special request (upcharges apply).

Glass Nominal = Actual Size Modesty Mount Clip Screens

Material	Where Used	Screen Type	Sized For	Mount Type
Glass 1/4" or Glass 3/8"	Bottom of Worksurface	Clip	Nominal = Actual Size	Modesty Mount

GLASS NOMINAL = ACTUAL FRAMELESS MODESTY MOUNT GLASS SCREENS

H	W	Model Number	Clear 1/4"	Grey Tinted 1/4"	Frosted 1/4"	Clear 3/8"	Frosted 3/8"
8	24	A-FGMM0824	896	+33	+68	+75	+136
8	30	A-FGMM0830	903	+41	+85	+78	+170
8	36	A-FGMM0836	965	+49	+102	+81	+204
8	42	A-FGMM0842	981	+57	+119	+84	+232
8	48	A-FGMM0848	994	+65	+135	+87	+270
8	54	A-FGMM0854	1,008	+73	+152	+91	+304
8	60	A-FGMM0860	1,039	+81	+169	+94	+338
8	66	A-FGMM0866	1,091	+89	+186	+97	+372
8	72	A-FGMM0872	1,097	+97	+203	+101	+406
12	24	A-FGMM1224	888	+38	+79	+141	+158
12	30	A-FGMM1230	896	+47	+99	+160	+198
12	36	A-FGMM1236	901	+57	+119	+180	+238
12	42	A-FGMM1242	929	+66	+138	+208	+276
12	48	A-FGMM1248	961	+76	+158	+236	+316
12	54	A-FGMM1254	1,080	+85	+178	+259	+356
12	60	A-FGMM1260	1,017	+94	+197	+291	+394
12	66	A-FGMM1266	1,048	+104	+217	+319	+434
12	72	A-FGMM1272	1,075	+113	+237	+347	+474

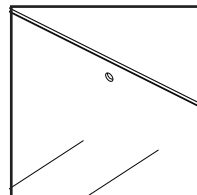
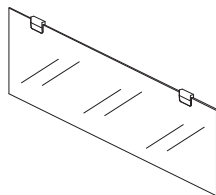

1/2" Pre-Drilled Holes

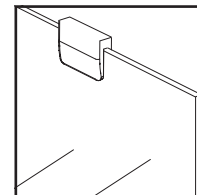

Modesty Mounted Clip

Specify

- Glass Thickness - 1/4" or 3/8"
- Glass Selection

Notes

- Frameless Modesty-Mount Glass Screens are designed to mount from the bottom of worksurfaces or other flat surfaces.
- Screens include two mounting brackets which are available in a matte chrome finish only, screens over 48" in length come with a third bracket.
- Modesty-Mount Glass Screens have a 1/2" pre-drilled holes to accept 1/4" set screws which work in conjunction with the mounting brackets. The set screws act as a safety device to prevent the glass from slipping from the brackets.
- Lexan available only in clear.

Glass Nominal = Actual Size Modesty Mount Clip Screens

Material	Where Used	Screen Type	Sized For	Mount Type
Glass 1/4" or Glass 3/8"	Bottom of Worksurface	Clip	Nominal = Actual Size	Modesty Mount

GLASS NOMINAL = ACTUAL FRAMELESS MODESTY MOUNT GLASS SCREENS

H	W	Model Number	Clear 1/4"	Grey Tinted 1/4"	Frosted 1/4"	Clear 3/8"	Frosted 3/8"
16	24	A-FGMM1624	1,016	+43	+90	+18	+180
16	30	A-FGMM1630	1,041	+54	+113	+59	+226
16	36	A-FGMM1636	1,080	+65	+135	+57	+270
16	42	A-FGMM1642	1,107	+76	+158	+105	+316
16	48	A-FGMM1648	1,140	+86	+180	+153	+360
16	54	A-FGMM1654	1,192	+97	+203	+165	+406
16	60	A-FGMM1660	1,240	+108	+225	+153	+450
16	66	A-FGMM1666	1,250	+119	+248	+220	+496
16	72	A-FGMM1672	1,277	+129	+270	+260	+540

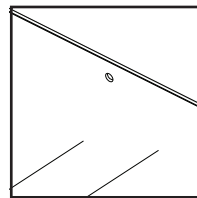
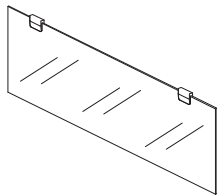

1/2" Pre-Drilled Holes

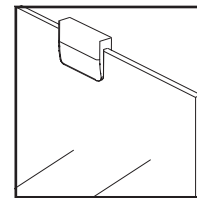

Modesty Mounted Clip

Specify

- Glass Thickness - 1/4" or 3/8"
- Glass Selection

Notes

- Frameless Modesty-Mount Glass Screens are designed to mount from the bottom of worksurfaces or other flat surfaces.
- Screens include two mounting brackets which are available in a matte chrome finish only, screens over 48" in length come with a third bracket.
- Modesty-Mount Glass Screens have a 1/2" pre-drilled holes to accept 1/4" set screws which work in conjunction with the mounting brackets. The set screws act as a safety device to prevent the glass from slipping from the brackets.
- Lexan available only in clear.

PET Nominal = Actual Size Territory Surface Mount Lite Screens

Material	Where Used	Screen Type	Sized For	Mount Type
PET	Territory on Worksurface	Lite	Nominal = Actual Size	Surface Mount

**PET NOMINAL = ACTUAL SIZE
TERRITORY SURFACE MOUNT LITE SCREENS**

H	D	Model Number	List
12	24	Y-5T4A1U1224B	494
16	24	Y-5T4A1U1624B	506
20	24	Y-5T4A1U2024B	518
24	24	Y-5T4A1U2424B	533
28	24	Y-5T4A1U2824B	544
32	24	Y-5T4A1U3224B	557
12	30	Y-5T4A1U1230B	504
16	30	Y-5T4A1U1630B	518
20	30	Y-5T4A1U2030B	535
24	30	Y-5T4A1U2430B	549
28	30	Y-5T4A1U2830B	567
32	30	Y-5T4A1U3230B	583

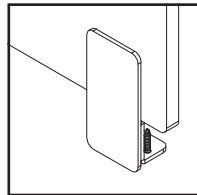
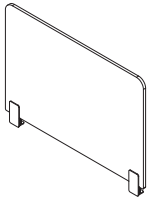

Surface Mount Lite

Specify

- Paint Selection for Lite Clip
- Color Selection for PET - Lite Grey, Medium Grey, Tan or Vibrant Blue

Notes

- PET Territory Screens are designed to mount to AIS worksurfaces. Specify based on nominal size for the desired system. Order screens that correspond to worksurface width.
- PET screen inserts are 1/2" (12mm) thick.

PET Nominal = Actual Size Territory Under Surface Mount Lite Screens

Material	Where Used	Screen Type	Sized For	Mount Type
PET	Territory on Worksurface	Lite	Nominal = Actual Size	Under Surface Mount

**PET NOMINAL = ACTUAL SIZE
TERRITORY UNDER SURFACE MOUNT LITE SCREENS**

H	D	Model Number	List
12	24	Y-5T4A2U1224B	494
16	24	Y-5T4A2U1624B	506
20	24	Y-5T4A2U2024B	518
24	24	Y-5T4A2U2424B	533
28	24	Y-5T4A2U2824B	544
32	24	Y-5T4A2U3224B	557
12	30	Y-5T4A2U1230B	504
16	30	Y-5T4A2U1630B	518
20	30	Y-5T4A2U2030B	535
24	30	Y-5T4A2U2430B	549
28	30	Y-5T4A2U2830B	567
32	30	Y-5T4A2U3230B	583

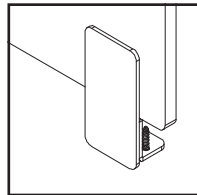
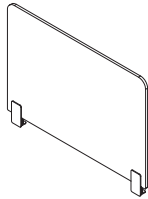

Under Surface Mount Lite

Specify

- Paint Selection for Lite Clip
- Color Selection for PET - Lite Grey, Medium Grey, Tan or Vibrant Blue

Notes

- PET Territory Screens are designed to mount to AIS worksurfaces. Specify based on nominal size for the desired system. Order screens that correspond to worksurface width.
- PET screen inserts are 1/2" (12mm) thick.

PET Nominal = Actual Size Territory Freestanding Lite Screens

Material	Where Used	Screen Type	Sized For	Mount Type
PET	Territory on Worksurface	Lite	Nominal = Actual Size	Freestanding

**PET NOMINAL = ACTUAL SIZE
TERRITORY FREESTANDING LITE SCREENS**

H	D	Model Number	List
12	24	Y-5T4A4U1224B	624
16	24	Y-5T4A4U1624B	637
20	24	Y-5T4A4U2024B	648
24	24	Y-5T4A4U2424B	663
28	24	Y-5T4A4U2824B	674
32	24	Y-5T4A4U3224B	687
12	30	Y-5T4A4U1230B	634
16	30	Y-5T4A4U1630B	648
20	30	Y-5T4A4U2030B	665
24	30	Y-5T4A4U2430B	680
28	30	Y-5T4A4U2830B	697
32	30	Y-5T4A4U3230B	713

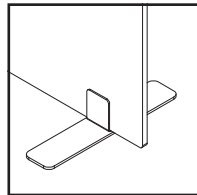
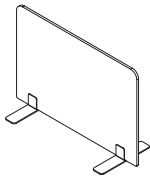

Freestanding Lite

Specify

- Paint Selection for Lite Clip
- Color Selection for PET - Lite Grey, Medium Grey, Tan or Vibrant Blue

Notes

- PET Territory Screens are designed to mount to AIS worksurfaces. Specify based on nominal size for the desired system. Order screens that correspond to worksurface width.
- PET screen inserts are 1/2" (12mm) thick.
- Non-marring feet measure 2 3/8" x 12".

PET Nominal = Actual Size Front/Rear Surface Mount Lite Screens

Material	Where Used	Screen Type	Sized For	Mount Type
PET	Front/Rear on Worksurface	Lite	Nominal = Actual Size	Surface Mount

**PET NOMINAL = ACTUAL SIZE
FRONT/REAR SURFACE MOUNT LITE SCREENS**

H	W	Model Number	List
12	24	Y-5R4A1U1224B	494
12	30	Y-5R4A1U1230B	504
12	36	Y-5R4A1U1236B	512
12	42	Y-5R4A1U1242B	521
12	48	Y-5R4A1U1248B	533
12	54	Y-5R4A1U1254B	542
12	60	Y-5R4A1U1260B	549
12	66	Y-5R4A1U1266B	562
12	72	Y-5R4A1U1272B	571
12	78	Y-5R4A1U1278B	578
12	84	Y-5R4A1U1284B	589
16	24	Y-5R4A1U1624B	506
16	30	Y-5R4A1U1630B	518
16	36	Y-5R4A1U1636B	533
16	42	Y-5R4A1U1642B	544
16	48	Y-5R4A1U1648B	557
16	54	Y-5R4A1U1654B	571
16	60	Y-5R4A1U1660B	583
16	66	Y-5R4A1U1666B	596
16	72	Y-5R4A1U1672B	607
16	78	Y-5R4A1U1678B	619
16	84	Y-5R4A1U1684B	634

**PET NOMINAL = ACTUAL SIZE
FRONT/REAR SURFACE MOUNT LITE SCREENS**

H	W	Model Number	List
20	24	Y-5R4A1U2024B	518
20	30	Y-5R4A1U2030B	535
20	36	Y-5R4A1U2036B	549
20	42	Y-5R4A1U2042B	567
20	48	Y-5R4A1U2048B	583
20	54	Y-5R4A1U2054B	599
20	60	Y-5R4A1U2060B	614
20	66	Y-5R4A1U2066B	631
20	72	Y-5R4A1U2072B	646
20	78	Y-5R4A1U2078B	663
20	84	Y-5R4A1U2084B	678
24	24	Y-5R4A1U2424B	533
24	30	Y-5R4A1U2430B	549
24	36	Y-5R4A1U2436B	571
24	42	Y-5R4A1U2442B	589
24	48	Y-5R4A1U2448B	607
24	54	Y-5R4A1U2454B	627
24	60	Y-5R4A1U2460B	646
24	66	Y-5R4A1U2466B	666
24	72	Y-5R4A1U2472B	684
24	78	Y-5R4A1U2478B	704
24	84	Y-5R4A1U2484B	724

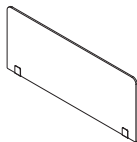

24 - 54 Wide

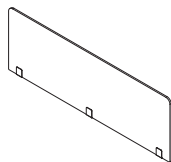

60 - 72 Wide

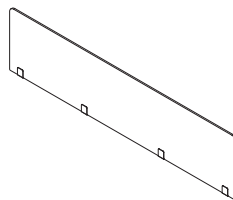

78 - 84 Wide

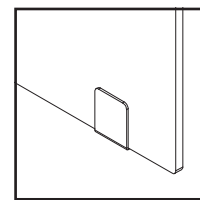

Surface Mount Lite

Specify

- Paint Selection for Lite Clip
- Color Selection for PET - Lite Grey, Medium Grey, Tan or Vibrant Blue

Notes

- PET Territory Screens are designed to mount to AIS worksurfaces. Specify based on nominal size for the desired system. Order screens that correspond to worksurface width.
- PET screen inserts are 1/2" (12mm) thick.

PET Nominal = Actual Size Front/Rear Surface Mount Lite Screens

Material	Where Used	Screen Type	Sized For	Mount Type
PET	Front/Rear on Worksurface	Lite	Nominal = Actual Size	Surface Mount

**PET NOMINAL = ACTUAL SIZE
FRONT/REAR SURFACE MOUNT LITE SCREENS**

H	W	Model Number	List
28	24	Y-5R4A1U2824B	544
28	30	Y-5R4A1U2830B	567
28	36	Y-5R4A1U2836B	589
28	42	Y-5R4A1U2842B	612
28	48	Y-5R4A1U2848B	634
28	54	Y-5R4A1U2854B	656
28	60	Y-5R4A1U2860B	678
28	66	Y-5R4A1U2866B	700
28	72	Y-5R4A1U2872B	724
28	78	Y-5R4A1U2878B	746
28	84	Y-5R4A1U2884B	767
32	24	Y-5R4A1U3224B	557
32	30	Y-5R4A1U3230B	583
32	36	Y-5R4A1U3236B	607
32	42	Y-5R4A1U3242B	634
32	48	Y-5R4A1U3248B	659
32	54	Y-5R4A1U3254B	684
32	60	Y-5R4A1U3260B	710
32	66	Y-5R4A1U3266B	736
32	72	Y-5R4A1U3272B	761
32	78	Y-5R4A1U3278B	788
32	84	Y-5R4A1U3284B	810

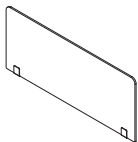

24 - 54 Wide

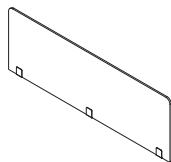

60 - 72 Wide

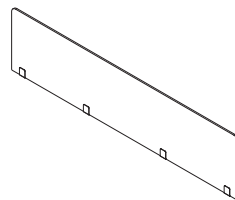

78 - 84 Wide

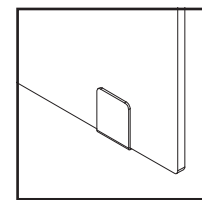

Surface Mount Lite

Specify

- Paint Selection for Lite Clip
- Color Selection for PET - Lite Grey, Medium Grey, Tan or Vibrant Blue

Notes

- PET Territory Screens are designed to mount to AIS worksurfaces. Specify based on nominal size for the desired system. Order screens that correspond to worksurface width.
- PET screen inserts are 1/2" (12mm) thick.

PET Nominal = Actual Size Front/Rear Under Surface Mount Lite Screens

Material	Where Used	Screen Type	Sized For	Mount Type
PET	Front/Rear on Worksurface	Lite	Nominal = Actual Size	Under Surface Mount

**PET NOMINAL = ACTUAL SIZE
FRONT/REAR UNDER SURFACE MOUNT LITE SCREENS**

H	W	Model Number	List
12	24	Y-5R4A2U1224B	494
12	30	Y-5R4A2U1230B	504
12	36	Y-5R4A2U1236B	512
12	42	Y-5R4A2U1242B	521
12	48	Y-5R4A2U1248B	533
12	54	Y-5R4A2U1254B	542
12	60	Y-5R4A2U1260B	549
12	66	Y-5R4A2U1266B	562
12	72	Y-5R4A2U1272B	571
12	78	Y-5R4A2U1278B	578
12	84	Y-5R4A2U1284B	589
16	24	Y-5R4A2U1624B	506
16	30	Y-5R4A2U1630B	518
16	36	Y-5R4A2U1636B	533
16	42	Y-5R4A2U1642B	544
16	48	Y-5R4A2U1648B	557
16	54	Y-5R4A2U1654B	571
16	60	Y-5R4A2U1660B	583
16	66	Y-5R4A2U1666B	596
16	72	Y-5R4A2U1672B	607
16	78	Y-5R4A2U1678B	619
16	84	Y-5R4A2U1684B	634

**PET NOMINAL = ACTUAL SIZE
FRONT/REAR UNDER SURFACE MOUNT LITE SCREENS**

H	W	Model Number	List
20	24	Y-5R4A2U2024B	518
20	30	Y-5R4A2U2030B	535
20	36	Y-5R4A2U2036B	549
20	42	Y-5R4A2U2042B	567
20	48	Y-5R4A2U2048B	583
20	54	Y-5R4A2U2054B	599
20	60	Y-5R4A2U2060B	614
20	66	Y-5R4A2U2066B	631
20	72	Y-5R4A2U2072B	646
20	78	Y-5R4A2U2078B	663
20	84	Y-5R4A2U2084B	678
24	24	Y-5R4A2U2424B	533
24	30	Y-5R4A2U2430B	549
24	36	Y-5R4A2U2436B	571
24	42	Y-5R4A2U2442B	589
24	48	Y-5R4A2U2448B	607
24	54	Y-5R4A2U2454B	627
24	60	Y-5R4A2U2460B	646
24	66	Y-5R4A2U2466B	666
24	72	Y-5R4A2U2472B	684
24	78	Y-5R4A2U2478B	704
24	84	Y-5R4A2U2484B	724

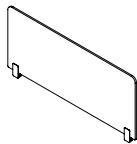

24 - 54 Wide

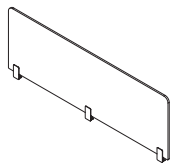

60 - 72 Wide

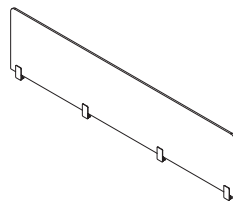

78 - 84 Wide

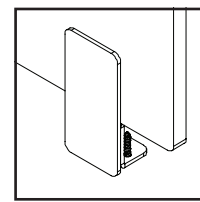

Under Surface Mount Lite

Specify

- Paint Selection for Lite Clip
- Color Selection for PET - Lite Grey, Medium Grey, Tan or Vibrant Blue

Notes

- PET Territory Screens are designed to mount to AIS worksurfaces. Specify based on nominal size for the desired system. Order screens that correspond to worksurface width.
- PET screen inserts are 1/2" (12mm) thick.

PET Nominal = Actual Size Front/Rear Under Surface Mount Lite Screens

Material	Where Used	Screen Type	Sized For	Mount Type
PET	Front/Rear on Worksurface	Lite	Nominal = Actual Size	Under Surface Mount

**PET NOMINAL = ACTUAL SIZE
FRONT/REAR UNDER SURFACE MOUNT LITE SCREENS**

H	W	Model Number	List
28	24	Y-5R4A2U2824B	544
28	30	Y-5R4A2U2830B	567
28	36	Y-5R4A2U2836B	589
28	42	Y-5R4A2U2842B	612
28	48	Y-5R4A2U2848B	634
28	54	Y-5R4A2U2854B	656
28	60	Y-5R4A2U2860B	678
28	66	Y-5R4A2U2866B	700
28	72	Y-5R4A2U2872B	724
28	78	Y-5R4A2U2878B	746
28	84	Y-5R4A2U2884B	767
32	24	Y-5R4A2U3224B	557
32	30	Y-5R4A2U3230B	583
32	36	Y-5R4A2U3236B	607
32	42	Y-5R4A2U3242B	634
32	48	Y-5R4A2U3248B	659
32	54	Y-5R4A2U3254B	684
32	60	Y-5R4A2U3260B	710
32	66	Y-5R4A2U3266B	736
32	72	Y-5R4A2U3272B	761
32	78	Y-5R4A2U3278B	788
32	84	Y-5R4A2U3284B	810

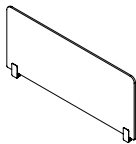

24 - 54 Wide

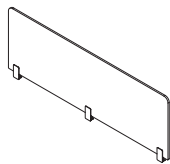

60 - 72 Wide

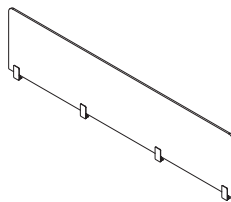

78 - 84 Wide

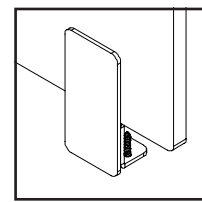

Under Surface Mount Lite

Specify

- Paint Selection for Lite Clip
- Color Selection for PET - Lite Grey, Medium Grey, Tan or Vibrant Blue

Notes

- PET Territory Screens are designed to mount to AIS worksurfaces. Specify based on nominal size for the desired system. Order screens that correspond to worksurface width.
- PET screen inserts are 1/2" (12mm) thick.

PET Nominal = Actual Size Front/Rear Freestanding Mount Lite Screens

Material	Where Used	Screen Type	Sized For	Mount Type
PET	Front/Rear on Worksurface	Lite	Nominal = Actual Size	Freestanding

**PET NOMINAL = ACTUAL SIZE
FRONT/REAR FREESTANDING LITE SCREENS**

H	W	Model Number	List
12	24	Y-5R4A4U1224B	624
12	30	Y-5R4A4U1230B	634
12	36	Y-5R4A4U1236B	643
12	42	Y-5R4A4U1242B	652
12	48	Y-5R4A4U1248B	663
12	54	Y-5R4A4U1254B	672
12	60	Y-5R4A4U1260B	746
12	66	Y-5R4A4U1266B	756
12	72	Y-5R4A4U1272B	765
12	78	Y-5R4A4U1278B	839
12	84	Y-5R4A4U1284B	848
16	24	Y-5R4A4U1624B	637
16	30	Y-5R4A4U1630B	648
16	36	Y-5R4A4U1636B	663
16	42	Y-5R4A4U1642B	674
16	48	Y-5R4A4U1648B	687
16	54	Y-5R4A4U1654B	699
16	60	Y-5R4A4U1660B	777
16	66	Y-5R4A4U1666B	791
16	72	Y-5R4A4U1672B	803
16	78	Y-5R4A4U1678B	880
16	84	Y-5R4A4U1684B	895

**PET NOMINAL = ACTUAL SIZE
FRONT/REAR FREESTANDING LITE SCREENS**

H	W	Model Number	List
20	24	Y-5R4A4U2024B	648
20	30	Y-5R4A4U2030B	665
20	36	Y-5R4A4U2036B	680
20	42	Y-5R4A4U2042B	697
20	48	Y-5R4A4U2048B	713
20	54	Y-5R4A4U2054B	728
20	60	Y-5R4A4U2060B	808
20	66	Y-5R4A4U2066B	827
20	72	Y-5R4A4U2072B	841
20	78	Y-5R4A4U2078B	922
20	84	Y-5R4A4U2084B	938
24	24	Y-5R4A4U2424B	663
24	30	Y-5R4A4U2430B	680
24	36	Y-5R4A4U2436B	699
24	42	Y-5R4A4U2442B	720
24	48	Y-5R4A4U2448B	737
24	54	Y-5R4A4U2454B	758
24	60	Y-5R4A4U2460B	841
24	66	Y-5R4A4U2466B	861
24	72	Y-5R4A4U2472B	879
24	78	Y-5R4A4U2478B	964
24	84	Y-5R4A4U2484B	984

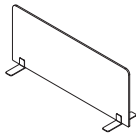

24 - 54 Wide

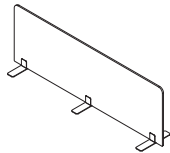

60 - 72 Wide

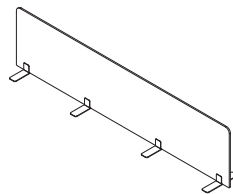

78 - 84 Wide

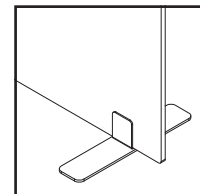

Freestanding Lite

Specify

- Paint Selection for Lite Clip
- Color Selection for PET - Lite Grey, Medium Grey, Tan or Vibrant Blue

Notes

- PET Territory Screens are designed to mount to AIS worksurfaces. Specify based on nominal size for the desired system. Order screens that correspond to worksurface width.
- PET screen inserts are 1/2" (12mm) thick.
- Non-marring feet measure 2 3/8" x 12".

PET Nominal = Actual Size Front/Rear Freestanding Mount Lite Screens

Material	Where Used	Screen Type	Sized For	Mount Type
PET	Front/Rear on Worksurface	Lite	Nominal = Actual Size	Freestanding

**PET NOMINAL = ACTUAL SIZE
FRONT/REAR FREESTANDING LITE SCREENS**

H	W	Model Number	List
28	24	Y-5R4A4U2824B	674
28	30	Y-5R4A4U2830B	697
28	36	Y-5R4A4U2836B	720
28	42	Y-5R4A4U2842B	740
28	48	Y-5R4A4U2848B	764
28	54	Y-5R4A4U2854B	787
28	60	Y-5R4A4U2860B	873
28	66	Y-5R4A4U2866B	897
28	72	Y-5R4A4U2872B	918
28	78	Y-5R4A4U2878B	1,006
28	84	Y-5R4A4U2884B	1,028
32	24	Y-5R4A4U3224B	687
32	30	Y-5R4A4U3230B	713
32	36	Y-5R4A4U3236B	737
32	42	Y-5R4A4U3242B	764
32	48	Y-5R4A4U3248B	790
32	54	Y-5R4A4U3254B	814
32	60	Y-5R4A4U3260B	906
32	66	Y-5R4A4U3266B	931
32	72	Y-5R4A4U3272B	956
32	78	Y-5R4A4U3278B	1,048
32	84	Y-5R4A4U3284B	1,071

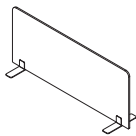

24 - 54 Wide

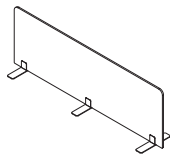

60 - 72 Wide

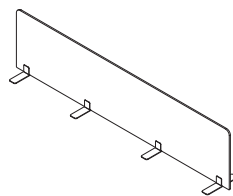

78 - 84 Wide

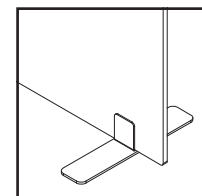

Freestanding Lite

Specify

- Paint Selection for Lite Clip
- Color Selection for PET - Lite Grey, Medium Grey, Tan or Vibrant Blue

Notes

- PET Territory Screens are designed to mount to AIS worksurfaces. Specify based on nominal size for the desired system. Order screens that correspond to worksurface width.
- PET screen inserts are 1/2" (12mm) thick.
- Non-marring feet measure 2 3/8" x 12".

PET Nominal = Actual Size Panel Top Surface Mount Lite Screens

Material	Where Used	Screen Type	Sized For	Mount Type
PET	Panel Top	Lite	Nominal = Actual Size	Surface Mount

**PET NOMINAL = ACTUAL SIZE
PANEL TOP SURFACE MOUNT LITE SCREENS**

H	W	Model Number	List
12	24	Y-5P4A1U1224B	494
12	30	Y-5P4A1U1230B	504
12	36	Y-5P4A1U1236B	512
12	42	Y-5P4A1U1242B	521
12	48	Y-5P4A1U1248B	533
12	54	Y-5P4A1U1254B	542
12	60	Y-5P4A1U1260B	549
12	66	Y-5P4A1U1266B	562
12	72	Y-5P4A1U1272B	571
12	78	Y-5P4A1U1278B	578
12	84	Y-5P4A1U1284B	589
16	24	Y-5P4A1U1624B	506
16	30	Y-5P4A1U1630B	518
16	36	Y-5P4A1U1636B	533
16	42	Y-5P4A1U1642B	544
16	48	Y-5P4A1U1648B	557
16	54	Y-5P4A1U1654B	571
16	60	Y-5P4A1U1660B	583
16	66	Y-5P4A1U1666B	596
16	72	Y-5P4A1U1672B	607
16	78	Y-5P4A1U1678B	619
16	84	Y-5P4A1U1684B	634

**PET NOMINAL = ACTUAL SIZE
PANEL TOP SURFACE MOUNT LITE SCREENS**

H	W	Model Number	List
20	24	Y-5P4A1U2024B	518
20	30	Y-5P4A1U2030B	535
20	36	Y-5P4A1U2036B	549
20	42	Y-5P4A1U2042B	567
20	48	Y-5P4A1U2048B	583
20	54	Y-5P4A1U2054B	599
20	60	Y-5P4A1U2060B	614
20	66	Y-5P4A1U2066B	631
20	72	Y-5P4A1U2072B	646
20	78	Y-5P4A1U2078B	663
20	84	Y-5P4A1U2084B	678
24	24	Y-5P4A1U2424B	533
24	30	Y-5P4A1U2430B	549
24	36	Y-5P4A1U2436B	571
24	42	Y-5P4A1U2442B	589
24	48	Y-5P4A1U2448B	607
24	54	Y-5P4A1U2454B	627
24	60	Y-5P4A1U2460B	646
24	66	Y-5P4A1U2466B	666
24	72	Y-5P4A1U2472B	684
24	78	Y-5P4A1U2478B	704
24	84	Y-5P4A1U2484B	724

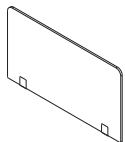

24 - 54 Wide

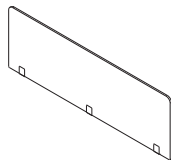

60 - 72 Wide

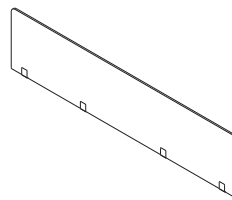

78 - 84 Wide

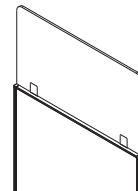

On Panel Top

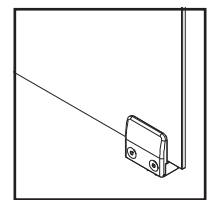

Surface Mount Clip

Specify

- Paint Selection
- Color Selection for PET - Lite Grey, Medium Grey, Tan or Vibrant Blue

Notes

- Can not be used on Matrix or Divi. For Matrix see Matrix price list, for Divi see section in Screens price list.
- PET Territory Screens are designed to mount to AIS worksurfaces. Specify based on nominal size for the desired system. Order screens that correspond to worksurface width.
- PET screen inserts are 1/2" (12mm) thick.

PET Nominal = Actual Size Panel Top Surface Mount Lite Screens

Material	Where Used	Screen Type	Sized For	Mount Type
PET	Panel Top	Lite	Nominal = Actual Size	Surface Mount

**PET NOMINAL = ACTUAL SIZE
PANEL TOP SURFACE MOUNT LITE SCREENS**

H	W	Model Number	List
28	24	Y-5P4A1U2824B	544
28	30	Y-5P4A1U2830B	567
28	36	Y-5P4A1U2836B	589
28	42	Y-5P4A1U2842B	612
28	48	Y-5P4A1U2848B	634
28	54	Y-5P4A1U2854B	656
28	60	Y-5P4A1U2860B	678
28	66	Y-5P4A1U2866B	700
28	72	Y-5P4A1U2872B	724
28	78	Y-5P4A1U2878B	746
28	84	Y-5P4A1U2884B	767
32	24	Y-5P4A1U3224B	557
32	30	Y-5P4A1U3230B	583
32	36	Y-5P4A1U3236B	607
32	42	Y-5P4A1U3242B	634
32	48	Y-5P4A1U3248B	659
32	54	Y-5P4A1U3254B	684
32	60	Y-5P4A1U3260B	710
32	66	Y-5P4A1U3266B	736
32	72	Y-5P4A1U3272B	761
32	78	Y-5P4A1U3278B	788
32	84	Y-5P4A1U3284B	810

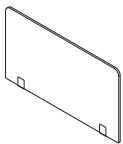

24 - 54 Wide

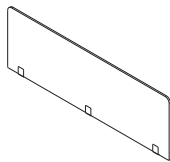

60 - 72 Wide

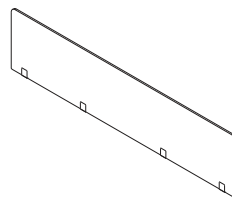

78 - 84 Wide

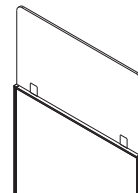

On Panel Top

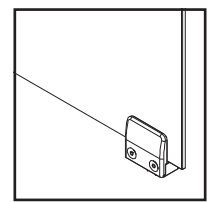

Surface Mount Clip

Specify

- Paint Selection
- Color Selection for PET - Lite Grey, Medium Grey, Tan or Vibrant Blue

Notes

- Can not be used on Matrix or Divi. For Matrix see Matrix price list, for Divi see section in Screens price list.
- PET Territory Screens are designed to mount to AIS worksurfaces. Specify based on nominal size for the desired system. Order screens that correspond to worksurface width.
- PET screen inserts are 1/2" (12mm) thick.

Nominal = Actual Size Territory Surface Mount Slimline Screens

Material	Where Used	Screen Type	Sized For	Mount Type
Fabric/Vinyl/Whiteboard/Laminate	Territory on Worksurface	Slimline	Nominal = Actual Size	Surface Mount

**NOMINAL = ACTUAL SIZE
TERRITORY SURFACE MOUNT SLIMLINE SCREENS**

H	D	Model Number	List	Fabric Grade C	Fabric Grade D
12	24	Y-6T1A1U1224B	647	+7	+14
16	24	Y-6T1A1U1624B	715	+11	+22
20	24	Y-6T1A1U2024B	648	+15	+30
24	24	Y-6T1A1U2424B	693	+18	+36
28	24	Y-6T1A1U2824B	767	+21	+42
12	30	Y-6T1A1U1230B	555	+7	+14
16	30	Y-6T1A1U1630B	715	+11	+22
20	30	Y-6T1A1U2030B	787	+15	+30
24	30	Y-6T1A1U2430B	830	+18	+36
28	30	Y-6T1A1U2830B	912	+21	+42

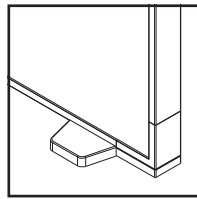
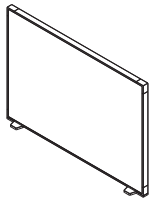

Surface Mount Slimline

Specify

- Paint Selection (+15 for Grade C)
- Fabric, Vinyl, Whiteboard or Laminate Selection

Notes

- Slimline screens may be fabric, vinyl, whiteboard or laminate on either side. Upcharges for Grade C and D are listed per side. Whiteboards are standard list and have no upcharge.
- Offered in all AIS paint finishes.

Nominal = Actual Size Territory Under Surface Mount Slimline Screens

Material	Where Used	Screen Type	Sized For	Mount Type	Handedness
Fabric/Vinyl/Whiteboard/Laminate	Territory on Worksurface	Slimline	Nominal = Actual Size	Under Surface Mount	Left or Right

NOMINAL = ACTUAL SIZE TERRITORY UNDER SURFACE MOUNT SLIMLINE SCREENS

H	D	Left Hand	Right Hand	List	Fabric Grade C	Fabric Grade D
		Model Number	Model Number			
12	24	A-STWL1230	A-STWR1230	647	+7	+14
16	24	A-STWL1630	A-STWR1630	715	+11	+22
20	24	A-STWL2024	A-STWR2024	648	+15	+30
24	24	A-STWL2424	A-STWR2424	693	+18	+36
28	24	A-STWL2824	A-STWR2824	767	+21	+42
12	30	A-STWL1224	A-STWR1224	555	+7	+14
16	30	A-STWL1630	A-STWR1630	715	+11	+22
20	30	A-STWL2030	A-STWR2030	787	+15	+30
24	30	A-STWL2430	A-STWR2430	830	+18	+36
28	30	A-STWL2830	A-STWR2830	912	+21	+42

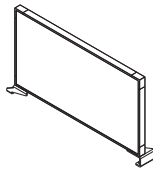

Left Hand

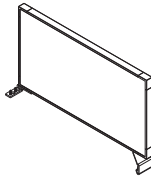

Right Hand

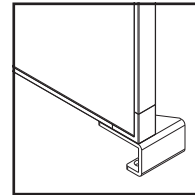

Under Surface Mount Slimline

Specify

- Paint Selection (+15 for Grade C)
- Fabric, Vinyl, Whiteboard or Laminate Selection

Notes

- Slimline screens may be fabric, vinyl, whiteboard or laminate on either side. Upcharges for Grade C and D are listed per side. Whiteboards are standard list and have no upcharge.
- Offered in all AIS paint finishes.

Nominal = Actual Size Front/Rear Surface Mount Slimline Screens

Material	Where Used	Screen Type	Sized For	Mount Type
Fabric/Vinyl/Whiteboard/Laminate	Front/Rear on Worksurface	Slimline	Nominal = Actual Size	Surface Mount

**NOMINAL = ACTUAL SIZE
FRONT/REAR SURFACE MOUNT SLIMLINE SCREENS**

H	W	Model Number	List	Fabric Grade C	Fabric Grade D
12	36	Y-6R1A1U1236B	582	+7	+14
12	42	Y-6R1A1U1242B	613	+7	+14
12	48	Y-6R1A1U1248B	645	+7	+14
12	54	Y-6R1A1U1254B	678	+7	+14
12	60	Y-6R1A1U1260B	709	+7	+14
12	66	Y-6R1A1U1266B	920	+7	+14
12	72	Y-6R1A1U1272B	979	+7	+14
16	36	Y-6R1A1U1636B	650	+11	+22
16	42	Y-6R1A1U1642B	685	+11	+22
16	48	Y-6R1A1U1648B	722	+11	+22
16	54	Y-6R1A1U1654B	758	+11	+22
16	60	Y-6R1A1U1660B	793	+11	+22
16	66	Y-6R1A1U1666B	972	+11	+22
16	72	Y-6R1A1U1672B	1,032	+11	+22
20	36	Y-6R1A1U2036B	720	+15	+30
20	42	Y-6R1A1U2042B	759	+15	+30
20	48	Y-6R1A1U2048B	798	+15	+30
20	54	Y-6R1A1U2054B	835	+15	+30
20	60	Y-6R1A1U2060B	874	+15	+30
20	66	Y-6R1A1U2066B	1,022	+15	+30
20	72	Y-6R1A1U2072B	1,088	+15	+30

**NOMINAL = ACTUAL SIZE
FRONT/REAR SURFACE MOUNT SLIMLINE SCREENS**

H	W	Model Number	List	Fabric Grade C	Fabric Grade D
24	36	Y-6R1A1U2436B	789	+18	+36
24	42	Y-6R1A1U2442B	831	+18	+36
24	48	Y-6R1A1U2448B	874	+18	+36
24	54	Y-6R1A1U2454B	912	+18	+36
24	60	Y-6R1A1U2460B	956	+18	+36
24	66	Y-6R1A1U2466B	1,071	+18	+36
24	72	Y-6R1A1U2472B	1,141	+18	+36
28	36	Y-6R1A1U2836B	858	+21	+42
28	42	Y-6R1A1U2842B	904	+21	+42
28	48	Y-6R1A1U2848B	951	+21	+42
28	54	Y-6R1A1U2854B	991	+21	+42
28	60	Y-6R1A1U2860B	1,037	+21	+42
28	66	Y-6R1A1U2866B	1,122	+21	+42
28	72	Y-6R1A1U2872B	1,197	+21	+42

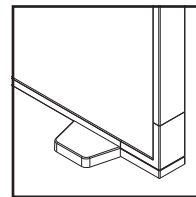
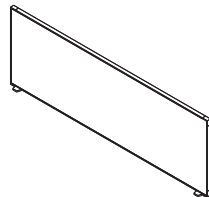

Specify

- Paint Selection (+15 for Grade C)
- Fabric, Vinyl, Whiteboard or Laminate Selection

Notes

- Slimline screens may be fabric, vinyl, whiteboard or laminate on either side. Upcharges for Grade C and D are listed per side. Whiteboards are standard list and have no upcharge.
- Offered in all AIS paint finishes.

Nominal = Actual Size Front/Rear Under Surface Mount Slimline Screens

Material	Where Used	Screen Type	Sized For	Mount Type
Fabric/Vinyl/Whiteboard/Laminate	Front/Rear on Worksurface	Slimline	Nominal = Actual Size	Under Surface Mount

**NOMINAL = ACTUAL SIZE
FRONT/REAR UNDER SURFACE MOUNT SLIMLINE SCREENS**

H	W	Model Number	List	Fabric Grade C	Fabric Grade D
12	36	A-SWMR1236	582	+7	+14
12	42	A-SWMR1242	613	+7	+14
12	48	A-SWMR1248	645	+7	+14
12	54	A-SWMR1254	678	+7	+14
12	60	A-SWMR1260	709	+7	+14
12	66	A-SWMR1266	920	+7	+14
12	72	A-SWMR1272	979	+7	+14
16	36	A-SWMR1636	650	+11	+22
16	42	A-SWMR1642	685	+11	+22
16	48	A-SWMR1648	722	+11	+22
16	54	A-SWMR1654	758	+11	+22
16	60	A-SWMR1660	793	+11	+22
16	66	A-SWMR1666	972	+11	+22
16	72	A-SWMR1672	1,032	+11	+22
20	36	A-SWMR2036	720	+15	+30
20	42	A-SWMR2042	759	+15	+30
20	48	A-SWMR2048	798	+15	+30
20	54	A-SWMR2054	835	+15	+30
20	60	A-SWMR2060	874	+15	+30
20	66	A-SWMR2066	1,022	+15	+30
20	72	A-SWMR2072	1,088	+15	+30

**NOMINAL = ACTUAL SIZE
FRONT/REAR UNDER SURFACE MOUNT SLIMLINE SCREENS**

H	W	Model Number	List	Fabric Grade C	Fabric Grade D
24	36	A-SWMR2436	789	+18	+36
24	42	A-SWMR2442	831	+18	+36
24	48	A-SWMR2448	874	+18	+36
24	54	A-SWMR2454	912	+18	+36
24	60	A-SWMR2460	956	+18	+36
24	66	A-SWMR2466	1,071	+18	+36
24	72	A-SWMR2472	1,141	+18	+36
28	36	A-SWMR2836	858	+21	+42
28	42	A-SWMR2842	904	+21	+42
28	48	A-SWMR2848	951	+21	+42
28	54	A-SWMR2854	991	+21	+42
28	60	A-SWMR2860	1,037	+21	+42
28	66	A-SWMR2866	1,122	+21	+42
28	72	A-SWMR2872	1,197	+21	+42

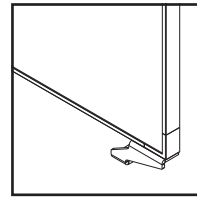
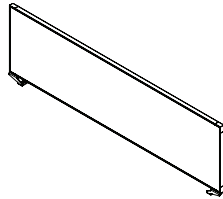

Under Surface Mount Slimline

Specify

- Paint Selection (+15 for Grade C)
- Fabric, Vinyl, Whiteboard or Laminate Selection

Notes

- Slimline screens may be fabric, vinyl, whiteboard or laminate on either side. Upcharges for Grade C and D are listed per side. Whiteboards are standard list and have no upcharge.
- Offered in all AIS paint finishes.

Nominal = Actual Size Front/Rear Freestanding Slimline Screens

Material	Where Used	Screen Type	Sized For	Mount Type
Fabric/Vinyl/Whiteboard/Laminate	Front/Rear on Worksurface	Slimline	Nominal = Actual Size	Freestanding

**NOMINAL = ACTUAL SIZE
FRONT/REAR FREESTANDING SLIMLINE SCREENS**

H	W	Model Number	List	Fabric Grade C	Fabric Grade D
12	36	Y-6R1A4U1236B	582	+7	+14
12	42	Y-6R1A4U1242B	613	+7	+14
12	48	Y-6R1A4U1248B	645	+7	+14
12	54	Y-6R1A4U1254B	678	+7	+14
12	60	Y-6R1A4U1260B	709	+7	+14
12	66	Y-6R1A4U1266B	920	+7	+14
12	72	Y-6R1A4U1272B	979	+7	+14
16	36	Y-6R1A4U1636B	650	+11	+22
16	42	Y-6R1A4U1642B	685	+11	+22
16	48	Y-6R1A4U1648B	722	+11	+22
16	54	Y-6R1A4U1654B	758	+11	+22
16	60	Y-6R1A4U1660B	793	+11	+22
16	66	Y-6R1A4U1666B	972	+11	+22
16	72	Y-6R1A4U1672B	1,032	+11	+22
20	36	Y-6R1A4U2036B	720	+15	+30
20	42	Y-6R1A4U2042B	759	+15	+30
20	48	Y-6R1A4U2048B	798	+15	+30
20	54	Y-6R1A4U2054B	835	+15	+30
20	60	Y-6R1A4U2060B	874	+15	+30
20	66	Y-6R1A4U2066B	1,022	+15	+30
20	72	Y-6R1A4U2072B	1,088	+15	+30

**NOMINAL = ACTUAL SIZE
FRONT/REAR FREESTANDING SLIMLINE SCREENS**

H	W	Model Number	List	Fabric Grade C	Fabric Grade D
24	36	Y-6R1A4U2436B	789	+18	+36
24	42	Y-6R1A4U2442B	831	+18	+36
24	48	Y-6R1A4U2448B	874	+18	+36
24	54	Y-6R1A4U2454B	912	+18	+36
24	60	Y-6R1A4U2460B	956	+18	+36
24	66	Y-6R1A4U2466B	1,071	+18	+36
24	72	Y-6R1A4U2472B	1,141	+18	+36
28	36	Y-6R1A4U2836B	858	+21	+42
28	42	Y-6R1A4U2842B	904	+21	+42
28	48	Y-6R1A4U2848B	951	+21	+42
28	54	Y-6R1A4U2854B	991	+21	+42
28	60	Y-6R1A4U2860B	1,037	+21	+42
28	66	Y-6R1A4U2866B	1,122	+21	+42
28	72	Y-6R1A4U2872B	1,197	+21	+42

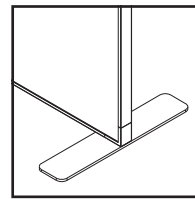
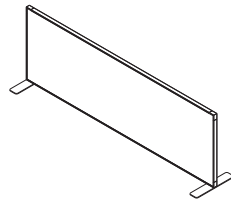

Freestanding Slimline

Specify

- Paint Selection (+15 for Grade C)
- Fabric, Vinyl, Whiteboard or Laminate Selection

Notes

- Slimline screens may be fabric, vinyl, whiteboard or laminate on either side. Upcharges for Grade C and D are listed per side. Whiteboards are standard list and have no upcharge.
- Offered in all AIS paint finishes.
- Non-marring feet measure 2 3/8" x 12".

Screens Sized for Divi Panel Dimensions

Lexan Divi Panel Top Surface Mount Channel Screens

Material	Where Used	Screen Type	Sized For	Mount Type
Lexan 1/4"	Panel Top	Channel	Divi Panel Dimensions	Surface Mount

LEXAN 1/4" DIVI PANEL TOP SURFACE MOUNT CHANNEL SCREENS

H	W	Model Number	List
12	24	Y-1P2B1U1224B	605
12	30	Y-1P2B1U1230B	642
12	36	Y-1P2B1U1236B	679
12	42	Y-1P2B1U1242B	717
12	48	Y-1P2B1U1248B	755
12	54	Y-1P2B1U1254B	791
12	60	Y-1P2B1U1260B	829
12	66	Y-1P2B1U1266B	867
12	72	Y-1P2B1U1272B	903
12	78	Y-1P2B1U1278B	939
12	84	Y-1P2B1U1284B	976
16	24	Y-1P2B1U1624B	655
16	30	Y-1P2B1U1630B	704
16	36	Y-1P2B1U1636B	755
16	42	Y-1P2B1U1642B	804
16	48	Y-1P2B1U1648B	855
16	54	Y-1P2B1U1654B	903
16	60	Y-1P2B1U1660B	954
16	66	Y-1P2B1U1666B	1,002
16	72	Y-1P2B1U1672B	1,052
16	78	Y-1P2B1U1678B	1,102
16	84	Y-1P2B1U1684B	1,154

LEXAN 1/4" DIVI PANEL TOP SURFACE MOUNT CHANNEL SCREENS

H	W	Model Number	List
20	24	Y-1P2B1U2024B	704
20	30	Y-1P2B1U2030B	766
20	36	Y-1P2B1U2036B	829
20	42	Y-1P2B1U2042B	890
20	48	Y-1P2B1U2048B	954
20	54	Y-1P2B1U2054B	1,017
20	60	Y-1P2B1U2060B	1,080
20	66	Y-1P2B1U2066B	1,141
20	72	Y-1P2B1U2072B	1,204
20	78	Y-1P2B1U2078B	1,267
20	84	Y-1P2B1U2084B	1,329

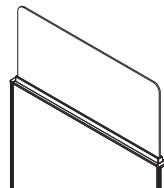
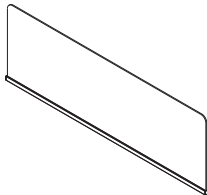

On Panel Top

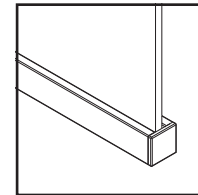

Surface Mount Channel

Specify

• Paint Selection (Grade C +10)

Notes

- For use with Divi only. See Clear & PET Screens price list for Panel Top Screens that can be used on non-Divi panels.
- Offered in all AIS paint finishes.
- Lexan available only in clear.

Glass Divi Panel Top Surface Mount Channel Screens

Material	Where Used	Screen Type	Sized For	Mount Type
Glass 1/4"	Panel Top	Channel	Divi Panel Dimensions	Surface Mount

GLASS 1/4" DIVI PANEL TOP SURFACE MOUNT CHANNEL SCREENS

H	W	Model Number	List	Tinted Glass	Frosted Glass
8	24	Y-3P2B1U0824B	432	30	110
8	30	Y-3P2B1U0830B	463	38	138
8	36	Y-3P2B1U0836B	493	45	165
8	42	Y-3P2B1U0842B	523	53	193
8	48	Y-3P2B1U0848B	553	60	220
8	54	Y-3P2B1U0854B	584	68	248
8	60	Y-3P2B1U0860B	614	75	275
8	66	Y-3P2B1U0866B	644	83	303
8	72	Y-3P2B1U0872B	674	90	330
8	78	Y-3P2B1U0878B	705	98	358
8	84	Y-3P2B1U0884B	735	105	385
12	24	Y-3P2B1U1224B	535	+30	+110
12	30	Y-3P2B1U1230B	542	+38	+138
12	36	Y-3P2B1U1236B	549	+45	+165
12	42	Y-3P2B1U1242B	578	+53	+193
12	48	Y-3P2B1U1248B	607	+60	+220
12	54	Y-3P2B1U1254B	727	+68	+248
12	60	Y-3P2B1U1260B	666	+75	+275
12	66	Y-3P2B1U1266B	695	+83	+303
12	72	Y-3P2B1U1272B	724	+90	+330
12	78	Y-3P2B1U1278B	753	+98	+358
12	84	Y-3P2B1U1284B	779	+105	+385

GLASS 1/4" DIVI PANEL TOP SURFACE MOUNT CHANNEL SCREENS

H	W	Model Number	List	Tinted Glass	Frosted Glass
16	24	Y-3P2B1U1624B	661	+40	+147
16	30	Y-3P2B1U1630B	687	+50	+184
16	36	Y-3P2B1U1636B	727	+60	+220
16	42	Y-3P2B1U1642B	756	+70	+257
16	48	Y-3P2B1U1648B	789	+80	+294
16	54	Y-3P2B1U1654B	840	+90	+330
16	60	Y-3P2B1U1660B	887	+100	+367
16	66	Y-3P2B1U1666B	899	+110	+404
16	72	Y-3P2B1U1672B	920	+120	+440
16	78	Y-3P2B1U1678B	937	+130	+477
16	84	Y-3P2B1U1684B	954	+140	+514

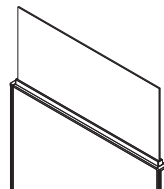
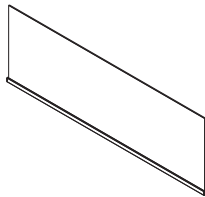

On Panel Top

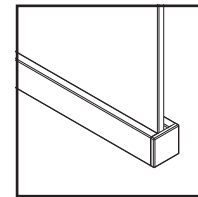

Surface Mount Channel

Specify

- Paint Selection (Grade C +10)

Notes

- For use with Divi only. See Clear & PET Screens price list for Panel Top Screens that can be used on non-Divi panels.
- Offered in all AIS paint finishes.
- Standard products for glass are always clear unless noted otherwise, other colors may be available upon special request (upcharges apply).

Glass Divi Panel Top Surface Mount Channel Screens

Material	Where Used	Screen Type	Sized For	Mount Type
Glass 1/4"	Panel Top	Channel	Divi Panel Dimensions	Surface Mount

GLASS 1/4" DIVI PANEL TOP SURFACE MOUNT CHANNEL SCREENS

H	W	Model Number	List	Tinted Glass	Frosted Glass
20	24	Y-3P2B1U2024B	606	+50	+184
20	30	Y-3P2B1U2030B	659	+63	+230
20	36	Y-3P2B1U2036B	695	+75	+275
20	42	Y-3P2B1U2042B	765	+88	+321
20	48	Y-3P2B1U2048B	816	+100	+367
20	54	Y-3P2B1U2054B	869	+113	+413
20	60	Y-3P2B1U2060B	922	+125	+459
20	66	Y-3P2B1U2066B	975	+138	+505
20	72	Y-3P2B1U2072B	1,028	+150	+550
20	78	Y-3P2B1U2078B	1,082	+163	+596
20	84	Y-3P2B1U2084B	1,133	+175	+642

GLASS 1/4" DIVI PANEL TOP SURFACE MOUNT CHANNEL SCREENS

H	W	Model Number	List	Tinted Glass	Frosted Glass
24	24	Y-3P2B1U2424B	647	+60	+220
24	30	Y-3P2B1U2430B	710	+75	+275
24	36	Y-3P2B1U2436B	773	+90	+330
24	42	Y-3P2B1U2442B	834	+105	+385
24	48	Y-3P2B1U2448B	897	+120	+440
24	54	Y-3P2B1U2454B	958	+135	+495
24	60	Y-3P2B1U2460B	1,021	+150	+550
24	66	Y-3P2B1U2466B	1,085	+165	+605
24	72	Y-3P2B1U2472B	1,145	+180	+660
24	78	Y-3P2B1U2478B	1,206	+195	+715
24	84	Y-3P2B1U2484B	1,267	+210	+770

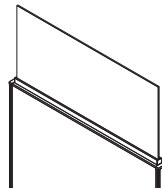
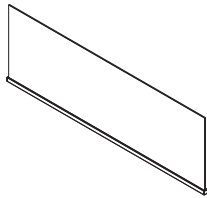

On Panel Top

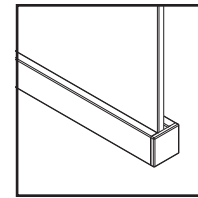

Surface Mount Channel

Specify

- Paint Selection (Grade C +10)

Notes

- For use with Divi only. See Clear & PET Screens price list for Panel Top Screens that can be used on non-Divi panels.
- Offered in all AIS paint finishes.
- Standard products for glass are always clear unless noted otherwise, other colors may be available upon special request (upcharges apply).

Glass Divi Panel Top Surface Mount Channel Screens

Material	Where Used	Screen Type	Sized For	Mount Type
Glass 3/8"	Panel Top	Channel	Divi Panel Dimensions	Surface Mount

GLASS 3/8" DIVI PANEL TOP SURFACE MOUNT CHANNEL SCREENS

H	W	Model Number	List	Tinted Glass	Frosted Glass
8	24	Y-4P2B1U0824B	648	30	60
8	30	Y-4P2B1U0830B	702	38	75
8	36	Y-4P2B1U0836B	756	45	90
8	42	Y-4P2B1U0842B	810	53	105
8	48	Y-4P2B1U0848B	864	60	120
8	54	Y-4P2B1U0854B	918	68	135
8	60	Y-4P2B1U0860B	972	75	150
8	66	Y-4P2B1U0866B	1,026	83	165
8	72	Y-4P2B1U0872B	1,080	90	180
8	78	Y-4P2B1U0878B	1,134	98	195
8	84	Y-4P2B1U0884B	1,188	105	210
12	24	Y-4P2B1U1224B	718	+30	+60
12	30	Y-4P2B1U1230B	722	+38	+75
12	36	Y-4P2B1U1236B	786	+45	+90
12	42	Y-4P2B1U1242B	848	+53	+105
12	48	Y-4P2B1U1248B	914	+60	+120
12	54	Y-4P2B1U1254B	979	+68	+135
12	60	Y-4P2B1U1260B	1,045	+75	+150
12	66	Y-4P2B1U1266B	1,109	+83	+165
12	72	Y-4P2B1U1272B	1,173	+90	+180
12	78	Y-4P2B1U1278B	1,239	+98	+195
12	84	Y-4P2B1U1284B	1,304	+105	+210

GLASS 3/8" DIVI PANEL TOP SURFACE MOUNT CHANNEL SCREENS

H	W	Model Number	List	Tinted Glass	Frosted Glass
16	24	Y-4P2B1U1624B	684	+40	+80
16	30	Y-4P2B1U1630B	764	+50	+100
16	36	Y-4P2B1U1636B	801	+60	+120
16	42	Y-4P2B1U1642B	891	+70	+140
16	48	Y-4P2B1U1648B	988	+80	+160
16	54	Y-4P2B1U1654B	1,056	+90	+180
16	60	Y-4P2B1U1660B	1,087	+100	+200
16	66	Y-4P2B1U1666B	1,184	+110	+220
16	72	Y-4P2B1U1672B	1,258	+120	+240
16	78	Y-4P2B1U1678B	1,280	+130	+260
16	84	Y-4P2B1U1684B	1,344	+140	+280

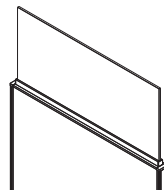
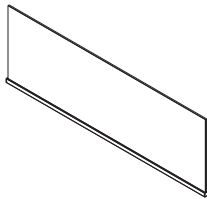

On Panel Top

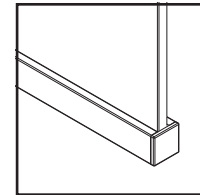

Surface Mount Channel

Specify

- Paint Selection (Grade C +10)

Notes

- For use with Divi only. See Clear & PET Screens price list for Panel Top Screens that can be used on non-Divi panels.
- Offered in all AIS paint finishes.
- Standard products for glass are always clear unless noted otherwise, other colors may be available upon special request (upcharges apply).

Glass Divi Panel Top Surface Mount Channel Screens

Material	Where Used	Screen Type	Sized For	Mount Type
Glass 3/8"	Panel Top	Channel	Divi Panel Dimensions	Surface Mount

GLASS 3/8" DIVI PANEL TOP SURFACE MOUNT CHANNEL SCREENS

H	W	Model Number	List	Tinted Glass	Frosted Glass
20	24	Y-4P2B1U2024B	780	+50	+100
20	30	Y-4P2B1U2030B	884	+63	+125
20	36	Y-4P2B1U2036B	984	+75	+150
20	42	Y-4P2B1U2042B	1,086	+88	+175
20	48	Y-4P2B1U2048B	1,184	+100	+200
20	54	Y-4P2B1U2054B	1,287	+113	+225
20	60	Y-4P2B1U2060B	1,387	+125	+250
20	66	Y-4P2B1U2066B	1,489	+138	+275
20	72	Y-4P2B1U2072B	1,587	+150	+300
20	78	Y-4P2B1U2078B	1,687	+163	+325
20	84	Y-4P2B1U2084B	1,788	+175	+350

GLASS 3/8" DIVI PANEL TOP SURFACE MOUNT CHANNEL SCREENS

H	W	Model Number	List	Tinted Glass	Frosted Glass
24	24	Y-4P2B1U2424B	855	+60	+120
24	30	Y-4P2B1U2430B	975	+75	+150
24	36	Y-4P2B1U2436B	1,093	+90	+180
24	42	Y-4P2B1U2442B	1,212	+105	+210
24	48	Y-4P2B1U2448B	1,331	+120	+240
24	54	Y-4P2B1U2454B	1,450	+135	+270
24	60	Y-4P2B1U2460B	1,571	+150	+300
24	66	Y-4P2B1U2466B	1,690	+165	+330
24	72	Y-4P2B1U2472B	1,807	+180	+360
24	78	Y-4P2B1U2478B	1,925	+195	+390
24	84	Y-4P2B1U2484B	2,044	+210	+420

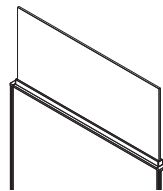
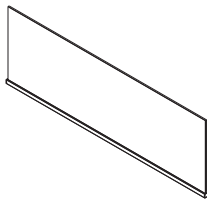

On Panel Top

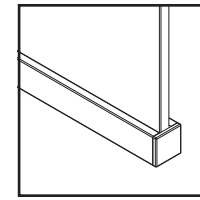

Surface Mount Channel

Specify

- Paint Selection (Grade C +10)

Notes

- For use with Divi only. See Clear & PET Screens price list for Panel Top Screens that can be used on non-Divi panels.
- Offered in all AIS paint finishes.
- Standard products for glass are always clear unless noted otherwise, other colors may be available upon special request (upcharges apply).

PET Divi Panel Top Surface Mount Channel Screens

Material	Where Used	Screen Type	Sized For	Mount Type
PET	Panel Top	Channel	Divi Panel Dimensions	Surface Mount

PET DIVI PANEL TOP SURFACE MOUNT CHANNEL SCREENS

H	W	Model Number	List
12	24	Y-5P2B1U1224B	464
12	30	Y-5P2B1U1230B	480
12	36	Y-5P2B1U1236B	497
12	42	Y-5P2B1U1242B	512
12	48	Y-5P2B1U1248B	531
12	54	Y-5P2B1U1254B	546
12	60	Y-5P2B1U1260B	563
12	66	Y-5P2B1U1266B	578
12	72	Y-5P2B1U1272B	594
12	78	Y-5P2B1U1278B	612
12	84	Y-5P2B1U1284B	627
16	24	Y-5P2B1U1624B	485
16	30	Y-5P2B1U1630B	507
16	36	Y-5P2B1U1636B	531
16	42	Y-5P2B1U1642B	551
16	48	Y-5P2B1U1648B	574
16	54	Y-5P2B1U1654B	594
16	60	Y-5P2B1U1660B	616
16	66	Y-5P2B1U1666B	639
16	72	Y-5P2B1U1672B	661
16	78	Y-5P2B1U1678B	683
16	84	Y-5P2B1U1684B	705

PET DIVI PANEL TOP SURFACE MOUNT CHANNEL SCREENS

H	W	Model Number	List
20	24	Y-5P2B1U2024B	507
20	30	Y-5P2B1U2030B	535
20	36	Y-5P2B1U2036B	563
20	42	Y-5P2B1U2042B	589
20	48	Y-5P2B1U2048B	617
20	54	Y-5P2B1U2054B	645
20	60	Y-5P2B1U2060B	673
20	66	Y-5P2B1U2066B	699
20	72	Y-5P2B1U2072B	727
20	78	Y-5P2B1U2078B	755
20	84	Y-5P2B1U2084B	780
24	24	Y-5P2B1U2424B	531
24	30	Y-5P2B1U2430B	563
24	36	Y-5P2B1U2436B	594
24	42	Y-5P2B1U2442B	628
24	48	Y-5P2B1U2448B	661
24	54	Y-5P2B1U2454B	694
24	60	Y-5P2B1U2460B	727
24	66	Y-5P2B1U2466B	760
24	72	Y-5P2B1U2472B	793
24	78	Y-5P2B1U2478B	826
24	84	Y-5P2B1U2484B	859

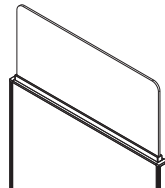
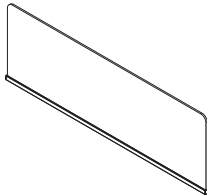

On Panel Top

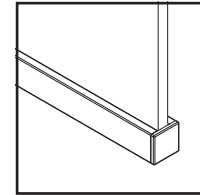

Surface Mount Channel

Specify

Notes

- Paint Selection (Grade C +10)
- Color Selection for PET - Lite Grey, Medium Grey, Tan or Vibrant Blue

- For use with Divi only. See Clear & PET Screens price list for Panel Top Screens that can be used on non-Divi panels.
- Offered in all AIS paint finishes.

PET Divi Panel Top Surface Mount Channel Screens

Material	Where Used	Screen Type	Sized For	Mount Type
PET	Panel Top	Channel	Divi Panel Dimensions	Surface Mount

PET DIVI PANEL TOP SURFACE MOUNT CHANNEL SCREENS

H	W	Model Number	List
28	24	Y-5P2B1U2824B	551
28	30	Y-5P2B1U2830B	589
28	36	Y-5P2B1U2836B	627
28	42	Y-5P2B1U2842B	666
28	48	Y-5P2B1U2848B	705
28	54	Y-5P2B1U2854B	742
28	60	Y-5P2B1U2860B	779
28	66	Y-5P2B1U2866B	820
28	72	Y-5P2B1U2872B	858
28	78	Y-5P2B1U2878B	897
28	84	Y-5P2B1U2884B	935
32	24	Y-5P2B1U3224B	574
32	30	Y-5P2B1U3230B	616
32	36	Y-5P2B1U3236B	659
32	42	Y-5P2B1U3242B	705
32	48	Y-5P2B1U3248B	748
32	54	Y-5P2B1U3254B	791
32	60	Y-5P2B1U3260B	835
32	66	Y-5P2B1U3266B	877
32	72	Y-5P2B1U3272B	922
32	78	Y-5P2B1U3278B	966
32	84	Y-5P2B1U3284B	1,010

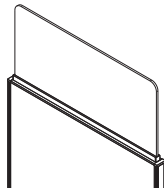
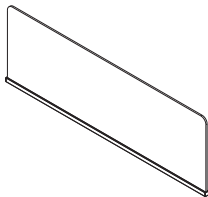

On Panel Top

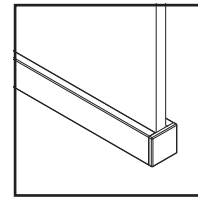

Surface Mount Channel

Specify

- Paint Selection (Grade C +10)
- Color Selection for PET - Lite Grey, Medium Grey, Tan or Vibrant Blue

Notes

- For use with Divi only. See Clear & PET Screens price list for Panel Top Screens that can be used on non-Divi panels.
- Offered in all AIS paint finishes.

Lexan Divi Gallery Panel Side Mount Channel Screens

Material	Where Used	Screen Type	Sized For	Mount Type
Lexan 3/8"	Gallery Panel Side Mount	Channel	Divi Gallery Panels	Surface Mount

LEXAN 3/8" DIVI GALLERY PANEL SIDE MOUNT CHANNEL SCREENS

H	W	Model Number	List
42	12	Y-2G2S1U4212B	885
42	18	Y-2G2S1U4218B	947
42	24	Y-2G2S1U4224B	1,073
50	12	Y-2G2S1U5012B	1,138
50	18	Y-2G2S1U5018B	1,106
50	24	Y-2G2S1U5024B	1,201
58	12	Y-2G2S1U5812B	1,393
58	18	Y-2G2S1U5818B	1,489
58	24	Y-2G2S1U5824B	1,329
66	12	Y-2G2S1U6612B	1,455
66	18	Y-2G2S1U6618B	1,710
66	24	Y-2G2S1U6624B	1,836

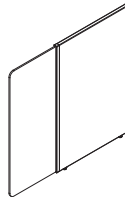

On Divi Gallery Panel

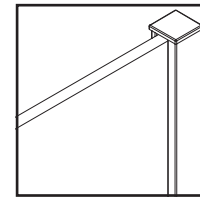

Surface Mount Channel

Specify

• Paint Selection (Grade C +10)

Notes

- For use with Divi gallery panels only.
- Offered in all AIS paint finishes.
- Lexan available only in clear.

PET Divi Gallery Panel Side Mount Channel Screens

Material	Where Used	Screen Type	Sized For	Mount Type
PET	Gallery Panel Side Mount	Channel	Divi Gallery Panels	Surface Mount

PET DIVI GALLERY PANEL SIDE MOUNT CHANNEL SCREENS

H	W	Model Number	List
42	12	Y-5G2S1U4212B	495
42	18	Y-5G2S1U4218B	511
42	24	Y-5G2S1U4224B	543
50	12	Y-5G2S1U5012B	559
50	18	Y-5G2S1U5018B	549
50	24	Y-5G2S1U5024B	574
58	12	Y-5G2S1U5812B	623
58	18	Y-5G2S1U5818B	645
58	24	Y-5G2S1U5824B	606
66	12	Y-5G2S1U6612B	638
66	18	Y-5G2S1U6618B	702
66	24	Y-5G2S1U6624B	734

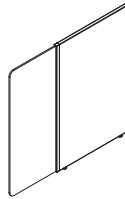

On Divi Gallery Panel

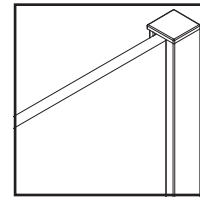

Surface Mount Channel

Specify

- Paint Selection (Grade C +10)
- Color Selection for PET - Lite Grey, Medium Grey, Tan or Vibrant Blue

Notes

- For use with Divi gallery panels only.
- Offered in all AIS paint finishes.

Lexan Divi Panel Top Surface Mount Clip Screens

Material	Where Used	Screen Type	Sized For	Mount Type
Lexan 1/4"	Panel Top	Clip	Divi Panel Dimensions	Surface Mount

LEXAN 1/4" DIVI PANEL TOP SURFACE MOUNT CLIP SCREENS

H	W	Model Number	List
12	24	Y-1P3B1U1224B	605
12	30	Y-1P3B1U1230B	642
12	36	Y-1P3B1U1236B	679
12	42	Y-1P3B1U1242B	717
12	48	Y-1P3B1U1248B	755
12	54	Y-1P3B1U1254B	791
12	60	Y-1P3B1U1260B	829
12	66	Y-1P3B1U1266B	867
12	72	Y-1P3B1U1272B	903
12	78	Y-1P3B1U1278B	939
12	84	Y-1P3B1U1284B	976
16	24	Y-1P3B1U1624B	655
16	30	Y-1P3B1U1630B	704
16	36	Y-1P3B1U1636B	755
16	42	Y-1P3B1U1642B	804
16	48	Y-1P3B1U1648B	855
16	54	Y-1P3B1U1654B	903
16	60	Y-1P3B1U1660B	954
16	66	Y-1P3B1U1666B	1,002
16	72	Y-1P3B1U1672B	1,052
16	78	Y-1P3B1U1678B	1,102
16	84	Y-1P3B1U1684B	1,154

LEXAN 1/4" DIVI PANEL TOP SURFACE MOUNT CLIP SCREENS

H	W	Model Number	List
20	24	Y-1P3B1U2024B	704
20	30	Y-1P3B1U2030B	766
20	36	Y-1P3B1U2036B	829
20	42	Y-1P3B1U2042B	890
20	48	Y-1P3B1U2048B	954
20	54	Y-1P3B1U2054B	1,017
20	60	Y-1P3B1U2060B	1,080
20	66	Y-1P3B1U2066B	1,141
20	72	Y-1P3B1U2072B	1,204
20	78	Y-1P3B1U2078B	1,267
20	84	Y-1P3B1U2084B	1,329

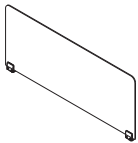

24 - 48 Wide

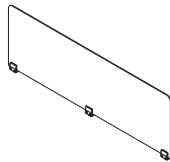

54 - 66 Wide

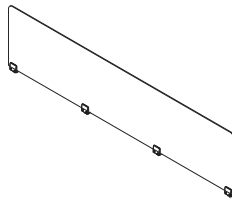

72 - 84 Wide

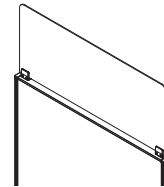

On Panel Top

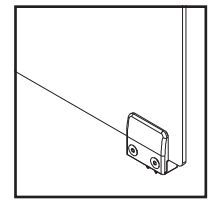

Surface Mount Clip

Specify

• Paint Selection

Notes

- For use with Divi only. See Clear & PET Screens price list for Panel Top Screens that can be used on non-Divi panels.
- Clips available in Metallic Silver only.
- Lexan available only in clear.

Glass Divi Panel Top Surface Mount Clip Screens

Material	Where Used	Screen Type	Sized For	Mount Type
Glass 1/4"	Panel Top	Clip	Divi Panel Dimensions	Surface Mount

GLASS 1/4" DIVI PANEL TOP SURFACE MOUNT CLIP SCREENS

H	W	Model Number	List	Tinted Glass	Frosted Glass
8	24	Y-3P3B1U0824B	432	30	110
8	30	Y-3P3B1U0830B	463	38	138
8	36	Y-3P3B1U0836B	493	45	165
8	42	Y-3P3B1U0842B	523	53	193
8	48	Y-3P3B1U0848B	553	60	220
8	54	Y-3P3B1U0854B	584	68	248
8	60	Y-3P3B1U0860B	614	75	275
8	66	Y-3P3B1U0866B	644	83	303
8	72	Y-3P3B1U0872B	674	90	330
8	78	Y-3P3B1U0878B	705	98	358
8	84	Y-3P3B1U0884B	735	105	385
12	24	Y-3P3B1U1224B	529	+30	+110
12	30	Y-3P3B1U1230B	542	+38	+138
12	36	Y-3P3B1U1236B	549	+45	+165
12	42	Y-3P3B1U1242B	578	+53	+193
12	48	Y-3P3B1U1248B	607	+60	+220
12	54	Y-3P3B1U1254B	619	+68	+248
12	60	Y-3P3B1U1260B	666	+75	+275
12	66	Y-3P3B1U1266B	695	+83	+303
12	72	Y-3P3B1U1272B	724	+90	+330
12	78	Y-3P3B1U1278B	753	+98	+358
12	84	Y-3P3B1U1284B	779	+105	+385

GLASS 1/4" DIVI PANEL TOP SURFACE MOUNT CLIP SCREENS

H	W	Model Number	List	Tinted Glass	Frosted Glass
16	24	Y-3P3B1U1624B	616	+40	+147
16	30	Y-3P3B1U1630B	659	+50	+184
16	36	Y-3P3B1U1636B	695	+60	+220
16	42	Y-3P3B1U1642B	756	+70	+257
16	48	Y-3P3B1U1648B	789	+80	+294
16	54	Y-3P3B1U1654B	840	+90	+330
16	60	Y-3P3B1U1660B	887	+100	+367
16	66	Y-3P3B1U1666B	899	+110	+404
16	72	Y-3P3B1U1672B	920	+120	+440
16	78	Y-3P3B1U1678B	937	+130	+477
16	84	Y-3P3B1U1684B	954	+140	+514

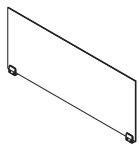

24 - 54 Wide

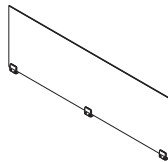

60 - 72 Wide

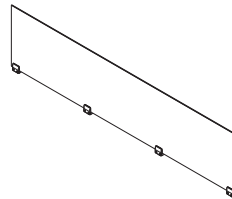

78 - 84 Wide

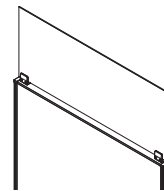

On Panel Top

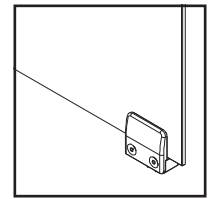

Surface Mount Clip

Specify

- Paint Selection

Notes

- For use with Divi only. See Clear & PET Screens price list for Panel Top Screens that can be used on non-Divi panels.
- Clips available in Metallic Silver only.
- Standard products for glass are always clear unless noted otherwise, other colors may be available upon special request (upcharges apply).

Glass Divi Panel Top Surface Mount Clip Screens

Material	Where Used	Screen Type	Sized For	Mount Type
Glass 1/4"	Panel Top	Clip	Divi Panel Dimensions	Surface Mount

GLASS 1/4" DIVI PANEL TOP SURFACE MOUNT CLIP SCREENS

H	W	Model Number	List	Tinted Glass	Frosted Glass
20	24	Y-3P3B1U2024B	661	+50	+184
20	30	Y-3P3B1U2030B	687	+63	+230
20	36	Y-3P3B1U2036B	727	+75	+275
20	42	Y-3P3B1U2042B	765	+88	+321
20	48	Y-3P3B1U2048B	816	+100	+367
20	54	Y-3P3B1U2054B	869	+113	+413
20	60	Y-3P3B1U2060B	922	+125	+459
20	66	Y-3P3B1U2066B	975	+138	+505
20	72	Y-3P3B1U2072B	1,028	+150	+550
20	78	Y-3P3B1U2078B	1,082	+163	+596
20	84	Y-3P3B1U2084B	1,133	+175	+642

GLASS 1/4" DIVI PANEL TOP SURFACE MOUNT CLIP SCREENS

H	W	Model Number	List	Tinted Glass	Frosted Glass
24	24	Y-3P3B1U2424B	647	+60	+220
24	30	Y-3P3B1U2430B	710	+75	+275
24	36	Y-3P3B1U2436B	773	+90	+330
24	42	Y-3P3B1U2442B	834	+105	+385
24	48	Y-3P3B1U2448B	897	+120	+440
24	54	Y-3P3B1U2454B	958	+135	+495
24	60	Y-3P3B1U2460B	1,021	+150	+550
24	66	Y-3P3B1U2466B	1,085	+165	+605
24	72	Y-3P3B1U2472B	1,145	+180	+660
24	78	Y-3P3B1U2478B	1,206	+195	+715
24	84	Y-3P3B1U2484B	1,267	+210	+770

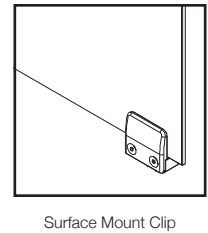
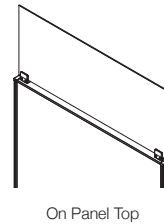
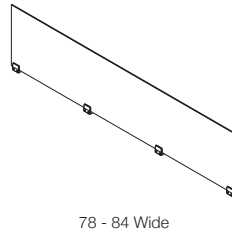
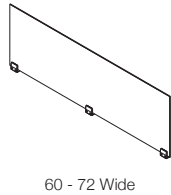
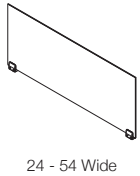

Specify

- Paint Selection

Notes

- For use with Divi only. See Clear & PET Screens price list for Panel Top Screens that can be used on non-Divi panels.
- Clips available in Metallic Silver only.
- Standard products for glass are always clear unless noted otherwise, other colors may be available upon special request (upcharges apply).

Glass Divi Panel Top Surface Mount Clip Screens

Material	Where Used	Screen Type	Sized For	Mount Type
Glass 3/8"	Panel Top	Clip	Divi Panel Dimensions	Surface Mount

GLASS 3/8" DIVI PANEL TOP SURFACE MOUNT CLIP SCREENS

H	W	Model Number	List	Tinted Glass	Frosted Glass
8	24	Y-4P3B1U0824B	648	30	60
8	30	Y-4P3B1U0830B	702	38	75
8	36	Y-4P3B1U0836B	756	45	90
8	42	Y-4P3B1U0842B	810	53	105
8	48	Y-4P3B1U0848B	864	60	120
8	54	Y-4P3B1U0854B	918	68	135
8	60	Y-4P3B1U0860B	1,045	75	150
8	66	Y-4P3B1U0866B	1,026	83	165
8	72	Y-4P3B1U0872B	1,080	90	180
8	78	Y-4P3B1U0878B	1,134	98	195
8	84	Y-4P3B1U0884B	1,188	105	210
12	24	Y-4P3B1U1224B	718	+30	+60
12	30	Y-4P3B1U1230B	722	+38	+75
12	36	Y-4P3B1U1236B	786	+45	+90
12	42	Y-4P3B1U1242B	848	+53	+105
12	48	Y-4P3B1U1248B	914	+60	+120
12	54	Y-4P3B1U1254B	979	+68	+135
12	60	Y-4P3B1U1260B	1,045	+75	+150
12	66	Y-4P3B1U1266B	1,109	+83	+165
12	72	Y-4P3B1U1272B	1,173	+90	+180
12	78	Y-4P3B1U1278B	1,239	+98	+195
12	84	Y-4P3B1U1284B	1,304	+105	+210

GLASS 3/8" DIVI PANEL TOP SURFACE MOUNT CLIP SCREENS

H	W	Model Number	List	Tinted Glass	Frosted Glass
16	24	Y-4P3B1U1624B	684	+40	+80
16	30	Y-4P3B1U1630B	764	+50	+100
16	36	Y-4P3B1U1636B	801	+60	+120
16	42	Y-4P3B1U1642B	891	+70	+140
16	48	Y-4P3B1U1648B	988	+80	+160
16	54	Y-4P3B1U1654B	1,056	+90	+180
16	60	Y-4P3B1U1660B	1,087	+100	+200
16	66	Y-4P3B1U1666B	1,184	+110	+220
16	72	Y-4P3B1U1672B	1,258	+120	+240
16	78	Y-4P3B1U1678B	1,280	+130	+260
16	84	Y-4P3B1U1684B	1,344	+140	+280

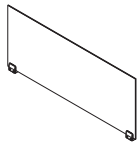

24 - 54 Wide

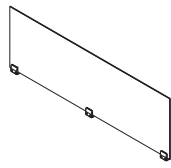

60 - 72 Wide

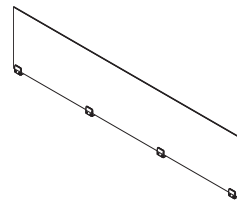

78 - 84 Wide

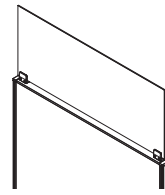

On Panel Top

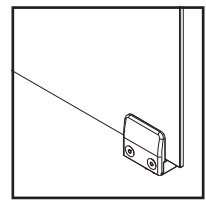

Surface Mount Clip

Specify

- Paint Selection

Notes

- For use with Divi only. See Clear & PET Screens price list for Panel Top Screens that can be used on non-Divi panels.
- Clips available in Metallic Silver only.
- Standard products for glass are always clear unless noted otherwise, other colors may be available upon special request (upcharges apply).

Glass Divi Panel Top Surface Mount Clip Screens

Material	Where Used	Screen Type	Sized For	Mount Type
Glass 3/8"	Panel Top	Clip	Divi Panel Dimensions	Surface Mount

GLASS 3/8" DIVI PANEL TOP SURFACE MOUNT CLIP SCREENS

H	W	Model Number	List	Tinted Glass	Frosted Glass
20	24	Y-4P3B1U2024B	780	+50	+100
20	30	Y-4P3B1U2030B	884	+63	+125
20	36	Y-4P3B1U2036B	984	+75	+150
20	42	Y-4P3B1U2042B	1,086	+88	+175
20	48	Y-4P3B1U2048B	1,184	+100	+200
20	54	Y-4P3B1U2054B	1,287	+113	+225
20	60	Y-4P3B1U2060B	1,387	+125	+250
20	66	Y-4P3B1U2066B	1,489	+138	+275
20	72	Y-4P3B1U2072B	1,587	+150	+300
20	78	Y-4P3B1U2078B	1,687	+163	+325
20	84	Y-4P3B1U2084B	1,788	+175	+350

GLASS 3/8" DIVI PANEL TOP SURFACE MOUNT CLIP SCREENS

H	W	Model Number	List	Tinted Glass	Frosted Glass
24	24	Y-4P3B1U2424B	855	+50	+100
24	30	Y-4P3B1U2430B	975	+63	+125
24	36	Y-4P3B1U2436B	1,093	+75	+150
24	42	Y-4P3B1U2442B	1,212	+88	+175
24	48	Y-4P3B1U2448B	1,331	+100	+200
24	54	Y-4P3B1U2454B	1,450	+113	+225
24	60	Y-4P3B1U2460B	1,571	+125	+250
24	66	Y-4P3B1U2466B	1,690	+138	+275
24	72	Y-4P3B1U2472B	1,807	+150	+300
24	78	Y-4P3B1U2478B	1,925	+163	+325
24	84	Y-4P3B1U2484B	2,044	+175	+350

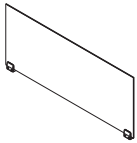

24 - 54 Wide

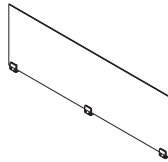

60 - 72 Wide

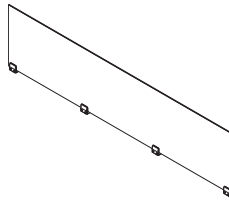

78 - 84 Wide

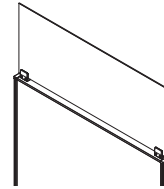

On Panel Top

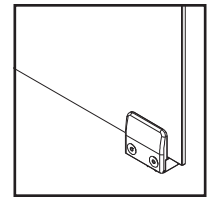

Surface Mount Clip

Specify

- Paint Selection

Notes

- For use with Divi only. See Clear & PET Screens price list for Panel Top Screens that can be used on non-Divi panels.
- Clips available in Metallic Silver only.
- Standard products for glass are always clear unless noted otherwise, other colors may be available upon special request (upcharges apply).

PET Divi Panel Top Surface Mount Lite Screens

Material	Where Used	Screen Type	Sized For	Mount Type
PET	Panel Top	Lite	Divi Panel Dimensions	Surface Mount

PET DIVI PANEL TOP SURFACE MOUNT LITE SCREENS

H	W	Model Number	List
12	24	Y-5P4B1U1224B	494
12	30	Y-5P4B1U1230B	504
12	36	Y-5P4B1U1236B	512
12	42	Y-5P4B1U1242B	521
12	48	Y-5P4B1U1248B	533
12	54	Y-5P4B1U1254B	542
12	60	Y-5P4B1U1260B	549
12	66	Y-5P4B1U1266B	562
12	72	Y-5P4B1U1272B	571
12	78	Y-5P4B1U1278B	578
12	84	Y-5P4B1U1284B	589
16	24	Y-5P4B1U1624B	506
16	30	Y-5P4B1U1630B	518
16	36	Y-5P4B1U1636B	533
16	42	Y-5P4B1U1642B	544
16	48	Y-5P4B1U1648B	557
16	54	Y-5P4B1U1654B	571
16	60	Y-5P4B1U1660B	583
16	66	Y-5P4B1U1666B	596
16	72	Y-5P4B1U1672B	607
16	78	Y-5P4B1U1678B	619
16	84	Y-5P4B1U1684B	634

PET DIVI PANEL TOP SURFACE MOUNT LITE SCREENS

H	W	Model Number	List
20	24	Y-5P4B1U2024B	518
20	30	Y-5P4B1U2030B	535
20	36	Y-5P4B1U2036B	549
20	42	Y-5P4B1U2042B	567
20	48	Y-5P4B1U2048B	583
20	54	Y-5P4B1U2054B	599
20	60	Y-5P4B1U2060B	614
20	66	Y-5P4B1U2066B	631
20	72	Y-5P4B1U2072B	646
20	78	Y-5P4B1U2078B	663
20	84	Y-5P4B1U2084B	678
24	24	Y-5P4B1U2424B	533
24	30	Y-5P4B1U2430B	549
24	36	Y-5P4B1U2436B	571
24	42	Y-5P4B1U2442B	589
24	48	Y-5P4B1U2448B	607
24	54	Y-5P4B1U2454B	627
24	60	Y-5P4B1U2460B	646
24	66	Y-5P4B1U2466B	666
24	72	Y-5P4B1U2472B	684
24	78	Y-5P4B1U2478B	704
24	84	Y-5P4B1U2484B	724

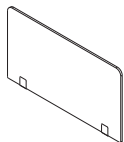

24 - 54 Wide

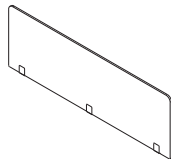

60 - 72 Wide

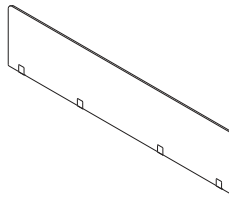

78 - 84 Wide

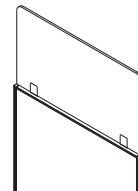

On Panel Top

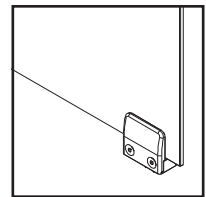

Surface Mount Clip

Specify

- Paint Selection (Grade C +10)
- Color Selection for PET - Lite Grey, Medium Grey, Tan or Vibrant Blue

Notes

- For use with Divi only. See Clear & PET Screens price list for Panel Top Screens that can be used on non-Divi panels.
- PET screen inserts are 1/2" (12mm) thick.

PET Divi Panel Top Surface Mount Lite Screens

Material	Where Used	Screen Type	Sized For	Mount Type
PET	Panel Top	Lite	Divi Panel Dimensions	Surface Mount

PET DIVI PANEL TOP SURFACE MOUNT LITE SCREENS

H	W	Model Number	List
28	24	Y-5P4B1U2824B	544
28	30	Y-5P4B1U2830B	567
28	36	Y-5P4B1U2836B	589
28	42	Y-5P4B1U2842B	612
28	48	Y-5P4B1U2848B	634
28	54	Y-5P4B1U2854B	656
28	60	Y-5P4B1U2860B	678
28	66	Y-5P4B1U2866B	700
28	72	Y-5P4B1U2872B	724
28	78	Y-5P4B1U2878B	746
28	84	Y-5P4B1U2884B	767
32	24	Y-5P4B1U3224B	557
32	30	Y-5P4B1U3230B	583
32	36	Y-5P4B1U3236B	607
32	42	Y-5P4B1U3242B	634
32	48	Y-5P4B1U3248B	659
32	54	Y-5P4B1U3254B	684
32	60	Y-5P4B1U3260B	710
32	66	Y-5P4B1U3266B	736
32	72	Y-5P4B1U3272B	761
32	78	Y-5P4B1U3278B	788
32	84	Y-5P4B1U3284B	810

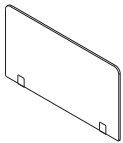

24 - 54 Wide

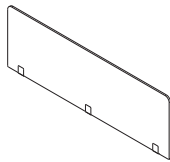

60 - 72 Wide

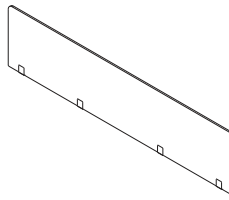

78 - 84 Wide

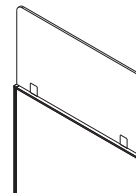

On Panel Top

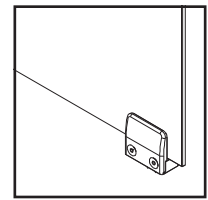

Surface Mount Clip

Specify

- Paint Selection (Grade C +10)
- Color Selection for PET - Lite Grey, Medium Grey, Tan or Vibrant Blue

Notes

- For use with Divi only. See Clear & PET Screens price list for Panel Top Screens that can be used on non-Divi panels.
- PET screen inserts are 1/2" (12mm) thick.

Screens Sized for Day-to-Day & Calibrate HAT Depths

Lexan Day-to-Day & Calibrate HAT Depth Territory Surface Mount Channel Screens

Material	Where Used	Screen Type	Sized For	Mount Type
Lexan 1/4"	Territory on Worksurface	Channel	Day-to-Day & Calibrate HAT Depth	Surface Mount

LEXAN 1/4" DAY-TO-DAY & CALIBRATE HAT DEPTH TERRITORY SURFACE MOUNT CHANNEL SCREENS

H	D	Model Number	List
12	24	Y-1T2D1U1224B	605
16	24	Y-1T2D1U1624B	655
20	24	Y-1T2D1U2024B	704
12	30	Y-1T2D1U1230B	642
16	30	Y-1T2D1U1630B	704
20	30	Y-1T2D1U2030B	766

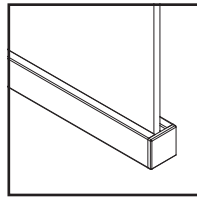
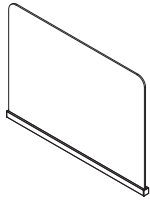

Surface Mount Channel

Specify

- Paint Selection (Grade C +10)

Notes

- Offered in all AIS paint finishes.
- Lexan available only in clear.

Glass Day-to-Day & Calibrate HAT Depth Territory Surface Mount Channel Screens

Material	Where Used	Screen Type	Sized For	Mount Type
Glass 1/4"	Territory on Worksurface	Channel	Day-to-Day & Calibrate HAT Depth	Surface Mount

GLASS 1/4" DAY-TO-DAY & CALIBRATE HAT DEPTH TERRITORY SURFACE MOUNT CHANNEL SCREENS

H	D	Model Number	List	Tinted Glass	Frosted Glass
12	24	Y-3T2D1U1224B	665	+30	+110
12	30	Y-3T2D1U1230B	672	+38	+138
16	24	Y-3T2D1U1624B	791	+40	+147
16	30	Y-3T2D1U1630B	816	+50	+184
20	24	Y-3T2D1U2024B	736	+40	+147
20	30	Y-3T2D1U2030B	790	+50	+184
24	24	Y-3T2D1U2424B	777	+60	+220
24	30	Y-3T2D1U2430B	840	+75	+275

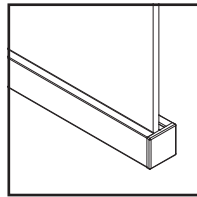
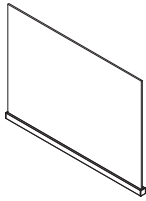

Surface Mount Channel

Specify

- Paint Selection (Grade C +10)

Notes

- Offered in all AIS paint finishes.
- Standard products for glass are always clear unless noted otherwise, other colors may be available upon special request (upcharges apply).

Glass Day-to-Day & Calibrate HAT Depth Territory Surface Mount Channel Screens

Material	Where Used	Screen Type	Sized For	Mount Type
Glass 3/8"	Territory on Worksurface	Channel	Day-to-Day & Calibrate HAT Depth	Surface Mount

GLASS 3/8" DAY-TO-DAY & CALIBRATE HAT DEPTH TERRITORY SURFACE MOUNT CHANNEL SCREENS

H	D	Model Number	List	Tinted Glass	Frosted Glass
12	24	Y-4T2D1U1224B	847	+30	+60
12	30	Y-4T2D1U1230B	850	+38	+75
16	24	Y-4T2D1U1624B	814	+30	+60
16	30	Y-4T2D1U1630B	895	+38	+75
20	24	Y-4T2D1U2024B	911	+50	+100
20	30	Y-4T2D1U2030B	1,015	+63	+125
24	24	Y-4T2D1U2424B	985	+60	+120
24	30	Y-4T2D1U2430B	1,103	+75	+150

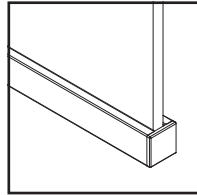
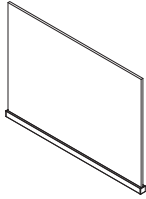

Surface Mount Channel

Specify

- Paint Selection (Grade C +10)

Notes

- Offered in all AIS paint finishes.
- Standard products for glass are always clear unless noted otherwise, other colors may be available upon special request (upcharges apply).

PET Day-to-Day & Calibrate HAT Depth Territory Surface Mount Channel Screens

Material	Where Used	Screen Type	Sized For	Mount Type
PET	Territory on Worksurface	Channel	Day-to-Day & Calibrate HAT Depth	Surface Mount

**PET DAY-TO-DAY & CALIBRATE HAT DEPTH
TERRITORY SURFACE MOUNT CHANNEL SCREENS**

H	D	Model Number	List
12	24	Y-5T2D1U1224B	464
16	24	Y-5T2D1U1624B	485
20	24	Y-5T2D1U2024B	507
24	24	Y-5T2D1U2424B	531
28	24	Y-5T2D1U2824B	551
32	24	Y-5T2D1U3224B	574
12	30	Y-5T2D1U1230B	480
16	30	Y-5T2D1U1630B	507
20	30	Y-5T2D1U2030B	535
24	30	Y-5T2D1U2430B	563
28	30	Y-5T2D1U2830B	589
32	30	Y-5T2D1U3230B	616

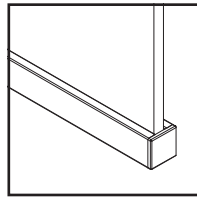
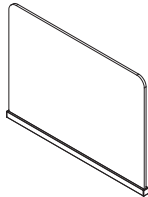

Surface Mount Channel

Specify

- Paint Selection (Grade C +10)
- Color Selection for PET - Lite Grey, Medium Grey, Tan or Vibrant Blue

Notes

- Offered in all AIS paint finishes.

Lexan Day-to-Day & Calibrate HAT Depth Territory Under Surface Mount Channel Screens

Material	Where Used	Screen Type	Sized For	Mount Type	Handedness
Lexan 1/4"	Territory on Worksurface	Channel	Day-to-Day & Calibrate HAT Depth	Under Surface Mount	Left or Right

**LEXAN 1/4" DAY-TO-DAY & CALIBRATE HAT DEPTH
TERRITORY UNDER SURFACE MOUNT CHANNEL SCREENS**

H	D	Left Hand	Right Hand	List
		Model Number	Model Number	
12	24	Y-1T2D2L1224B	Y-1T2D2R1224B	735
16	24	Y-1T2D2L1624B	Y-1T2D2R1624B	786
20	24	Y-1T2D2L2024B	Y-1T2D2R2024B	834
12	30	Y-1T2D2L1230B	Y-1T2D2R1230B	771
16	30	Y-1T2D2L1630B	Y-1T2D2R1630B	834
20	30	Y-1T2D2L2030B	Y-1T2D2R2030B	897

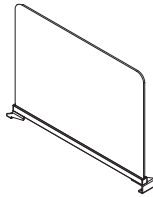

Left Hand

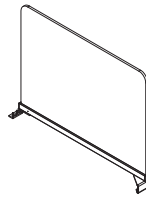

Right Hand

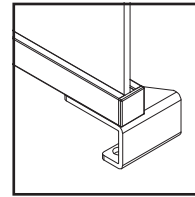

Under Surface Mount Channel

Specify

- Paint Selection (Grade C +10)

Notes

- Offered in all AIS paint finishes.
- Lexan available only in clear.

Glass Day-to-Day & Calibrate HAT Depth Territory Under Surface Mount Channel Screens

Material	Where Used	Screen Type	Sized For	Mount Type	Handedness
Glass 1/4"	Territory on Worksurface	Channel	Day-to-Day & Calibrate HAT Depth	Under Surface Mount	Left or Right

**GLASS 1/4" DAY-TO-DAY & CALIBRATE HAT DEPTH
TERRITORY UNDER SURFACE MOUNT CHANNEL SCREENS**

H	D	Territory		List	Tinted Glass	Frosted Glass
		Left Hand	Right Hand			
		Model Number	Model Number			
12	24	Y-3T2D2L1224B	Y-3T2D2R1224B	665	+30	+110
12	30	Y-3T2D2L1230B	Y-3T2D2R1230B	672	+38	+138
16	24	Y-3T2D2L1624B	Y-3T2D2R1624B	791	+40	+147
16	30	Y-3T2D2L1630B	Y-3T2D2R1630B	816	+50	+184
20	24	Y-3T2D2L2024B	Y-3T2D2R2024B	736	+50	+184
20	30	Y-3T2D2L2030B	Y-3T2D2R2030B	790	+63	+230
24	24	Y-3T2D2L2424B	Y-3T2D2R2424B	777	+60	+220
24	30	Y-3T2D2L2430B	Y-3T2D2R2430B	840	+75	+275

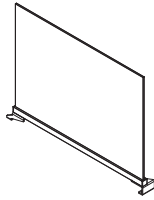

Left Hand

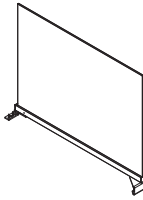

Right Hand

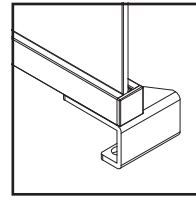

Under Surface Mount Channel

Specify

- Paint Selection (Grade C +10)

Notes

- Offered in all AIS paint finishes.
- Standard products for glass are always clear unless noted otherwise, other colors may be available upon special request (upcharges apply).

Glass Day-to-Day & Calibrate HAT Depth Territory Under Surface Mount Channel Screens

Material	Where Used	Screen Type	Sized For	Mount Type	Handedness
Glass 3/8"	Territory on Worksurface	Channel	Day-to-Day & Calibrate HAT Depth	Under Surface Mount	Left or Right

**GLASS 3/8" DAY-TO-DAY & CALIBRATE HAT DEPTH
TERRITORY UNDER SURFACE MOUNT CHANNEL SCREENS**

H	D	Left Hand	Right Hand	List	Tinted Glass	Frosted Glass
		Model Number	Model Number			
12	24	Y-4T2D2L1224B	Y-4T2D2R1224B	847	+30	+60
12	30	Y-4T2D2L1230B	Y-4T2D2R1230B	850	+38	+75
16	24	Y-4T2D2L1624B	Y-4T2D2R1624B	814	+40	+80
16	30	Y-4T2D2L1630B	Y-4T2D2R1630B	895	+50	+100
20	24	Y-4T2D2L2024B	Y-4T2D2R2024B	911	+50	+100
20	30	Y-4T2D2L2030B	Y-4T2D2R2030B	1,015	+63	+125
24	24	Y-4T2D2L2424B	Y-4T2D2R2424B	985	+60	+120
24	30	Y-4T2D2L2430B	Y-4T2D2R2430B	1,103	+75	+150

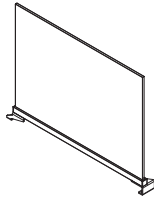

Left Hand

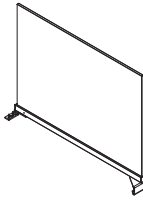

Right Hand

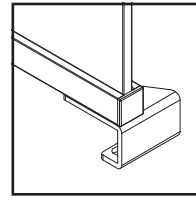

Under Surface Mount Channel

Specify

- Paint Selection (Grade C +10)

Notes

- Offered in all AIS paint finishes.
- Standard products for glass are always clear unless noted otherwise, other colors may be available upon special request (upcharges apply).

PET Day-to-Day & Calibrate HAT Depth Territory Under Surface Mount Channel Screens

Material	Where Used	Screen Type	Sized For	Mount Type	Handedness
PET	Territory on Worksurface	Channel	Day-to-Day & Calibrate HAT Depth	Under Surface Mount	Left or Right

**PET DAY-TO-DAY & CALIBRATE HAT DEPTH
TERRITORY UNDER SURFACE MOUNT CHANNEL SCREENS**

H	D	Left Hand	Right Hand	List
		Model Number	Model Number	
12	24	Y-5T2D2L1224B	Y-5T2D2R1224B	593
16	24	Y-5T2D2L1624B	Y-5T2D2R1624B	615
20	24	Y-5T2D2L2024B	Y-5T2D2R2024B	638
24	24	Y-5T2D2L2424B	Y-5T2D2R2424B	659
28	24	Y-5T2D2L2824B	Y-5T2D2R2824B	682
32	24	Y-5T2D2L3224B	Y-5T2D2R3224B	704
12	30	Y-5T2D2L1230B	Y-5T2D2R1230B	610
16	30	Y-5T2D2L1630B	Y-5T2D2R1630B	638
20	30	Y-5T2D2L2030B	Y-5T2D2R2030B	665
24	30	Y-5T2D2L2430B	Y-5T2D2R2430B	693
28	30	Y-5T2D2L2830B	Y-5T2D2R2830B	720
32	30	Y-5T2D2L3230B	Y-5T2D2R3230B	747

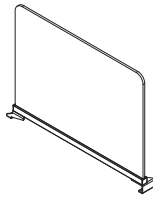

Left Hand

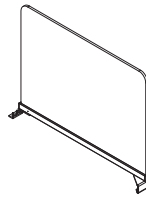

Right Hand

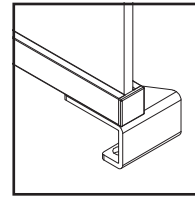

Under Surface Mount Channel

Specify

- Paint Selection (Grade C +10)
- Color Selection for PET - Lite Grey, Medium Grey, Tan or Vibrant Blue

Notes

- Offered in all AIS paint finishes.

Lexan Day-to-Day & Calibrate HAT Depth Territory Surface Mount Clip Screens

Material	Where Used	Screen Type	Sized For	Mount Type
Lexan 1/4"	Territory on Worksurface	Clip	Day-to-Day & Calibrate HAT Depth	Surface Mount

LEXAN 1/4" DAY-TO-DAY & CALIBRATE HAT DEPTH TERRITORY SURFACE MOUNT CLIP SCREENS WITHOUT CUT-OUTS

H	D	Model Number	List
12	24	Y-1T3D1U1224B	605
16	24	Y-1T3D1U1624B	655
20	24	Y-1T3D1U2024B	704
12	30	Y-1T3D1U1230B	642
16	30	Y-1T3D1U1630B	704
20	30	Y-1T3D1U2030B	766

LEXAN 1/4" DAY-TO-DAY & CALIBRATE HAT DEPTH TERRITORY SURFACE MOUNT CLIP SCREENS WITH CUT-OUTS

H	D	Model Number	List
12	24	Y-1T3D1U1224A	605
16	24	Y-1T3D1U1624A	655
20	24	Y-1T3D1U2024A	704
12	30	Y-1T3D1U1230A	642
16	30	Y-1T3D1U1630A	704
20	30	Y-1T3D1U2030A	766

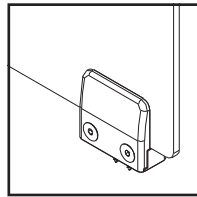
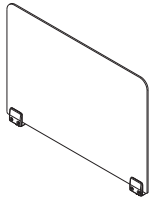

Surface Mount Clip

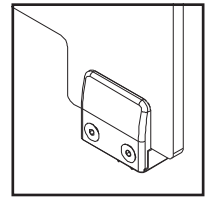
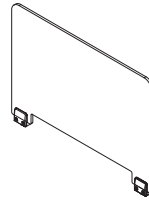

Surface Mount Clip

Specify

Notes

- Clips available in Metallic Silver only.
- Lexan available only in clear.

Glass Day-to-Day & Calibrate HAT Depth Territory Surface Mount Clip Screens

Material	Where Used	Screen Type	Sized For	Mount Type
Glass 1/4"	Territory on Worksurface	Clip	Day-to-Day & Calibrate HAT Depth	Surface Mount

GLASS 1/4" DAY-TO-DAY & CALIBRATE HAT DEPTH TERRITORY SURFACE MOUNT CLIP SCREENS WITHOUT CUT-OUTS

H	D	Model Number	List	Tinted Glass	Frosted Glass
12	24	Y-3T3D1U1224B	535	+30	+110
12	30	Y-3T3D1U1230B	542	+38	+138
16	24	Y-3T3D1U1624B	661	+40	+147
16	30	Y-3T3D1U1630B	687	+50	+184
20	24	Y-3T3D1U2024B	606	+50	+184
20	30	Y-3T3D1U2030B	659	+63	+230
24	24	Y-3T3D1U2424B	647	+60	+220
24	30	Y-3T3D1U2430B	710	+75	+275

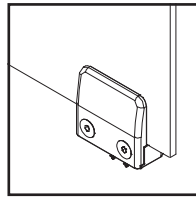
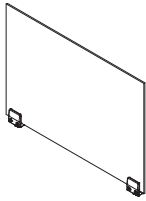

Surface Mount Clip

Specify

Notes

- Clips available in Metallic Silver only.
- Standard products for glass are always clear unless noted otherwise, other colors may be available upon special request (upcharges apply).

Glass Day-to-Day & Calibrate HAT Depth Territory Surface Mount Clip Screens

Material	Where Used	Screen Type	Sized For	Mount Type
Glass 3/8"	Territory on Worksurface	Clip	Day-to-Day & Calibrate HAT Depth	Surface Mount

**GLASS 3/8" DAY-TO-DAY & CALIBRATE HAT DEPTH
TERRITORY SURFACE MOUNT CLIP SCREENS WITHOUT CUT-OUTS**

H	D	Model Number	List	Tinted Glass	Frosted Glass
12	24	Y-4T3D1U1224B	718	+30	+60
12	30	Y-4T3D1U1230B	722	+38	+75
16	24	Y-4T3D1U1624B	684	+40	+80
16	30	Y-4T3D1U1630B	764	+50	+100
20	24	Y-4T3D1U2024B	780	+50	+100
20	30	Y-4T3D1U2030B	884	+63	+125
24	24	Y-4T3D1U2424B	855	+60	+120
24	30	Y-4T3D1U2430B	975	+75	+150

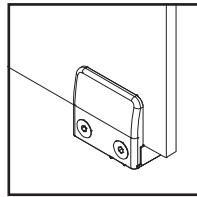
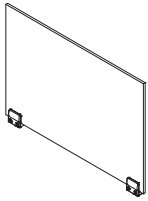

Surface Mount Clip

Specify

Notes

- Clips available in Metallic Silver only.
- Standard products for glass are always clear unless noted otherwise, other colors may be available upon special request (upcharges apply).

Lexan Day-to-Day & Calibrate HAT Depth Territory Under Surface Mount Clip Screens

Material	Where Used	Screen Type	Sized For	Mount Type	Handedness
Lexan 1/4"	Territory on Worksurface	Clip	Day-to-Day & Calibrate HAT Depth	Under Surface Mount	Left or Right

**LEXAN 1/4" DAY-TO-DAY & CALIBRATE HAT DEPTH
TERRITORY UNDER SURFACE MOUNT CLIP SCREENS WITHOUT CUT-OUTS**

H	D	Left Hand	Right Hand	List
		Model Number	Model Number	
12	24	Y-1T3D2L1224B	Y-1T3D2R1224B	605
16	24	Y-1T3D2L1624B	Y-1T3D2R1624B	655
20	24	Y-1T3D2L2024B	Y-1T3D2R2024B	704
12	30	Y-1T3D2L1230B	Y-1T3D2R1230B	642
16	30	Y-1T3D2L1630B	Y-1T3D2R1630B	704
20	30	Y-1T3D2L2030B	Y-1T3D2R2030B	766

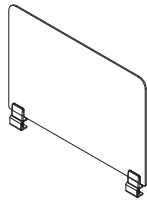

Left Hand

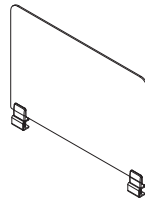

Right Hand

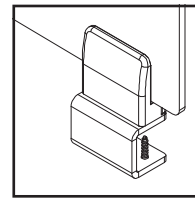

Under Surface Mount Clip

Specify

Notes

- Clips available in Metallic Silver only.
- Lexan available only in clear.

Lexan Day-to-Day & Calibrate HAT Depth Territory Under Surface Mount Clip Screens

Material	Where Used	Screen Type	Sized For	Mount Type	Handedness
Lexan 1/4"	Territory on Worksurface	Clip	Day-to-Day & Calibrate HAT Depth	Under Surface Mount	Left or Right

**LEXAN 1/4" DAY-TO-DAY & CALIBRATE HAT DEPTH
TERRITORY UNDER SURFACE MOUNT CLIP SCREENS WITH CUT-OUTS**

H	D	Left Hand	Right Hand	List
		Model Number	Model Number	
12	24	Y-1T3D2L1224A	Y-1T3D2R1224A	605
16	24	Y-1T3D2L1624A	Y-1T3D2R1624A	655
20	24	Y-1T3D2L2024A	Y-1T3D2R2024A	704
12	30	Y-1T3D2L1230A	Y-1T3D2R1230A	642
16	30	Y-1T3D2L1630A	Y-1T3D2R1630A	704
20	30	Y-1T3D2L2030A	Y-1T3D2R2030A	766

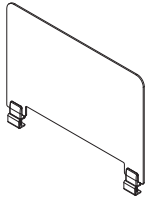

Left Hand

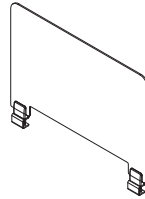

Right Hand

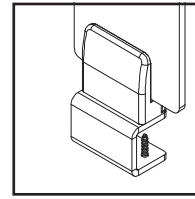

Under Surface Mount Clip

Specify

Notes

- Clips available in Metallic Silver only.
- Lexan available only in clear.

Glass Day-to-Day & Calibrate HAT Depth Territory Under Surface Mount Clip Screens

Material	Where Used	Screen Type	Sized For	Mount Type	Handedness
Glass 1/4"	Territory on Worksurface	Clip	Day-to-Day & Calibrate HAT Depth	Under Surface Mount	Left or Right

GLASS 1/4" DAY-TO-DAY & CALIBRATE HAT DEPTH TERRITORY UNDER SURFACE MOUNT CLIP SCREENS

H	D	Territory		List	Tinted Glass	Frosted Glass
		Left Hand	Right Hand			
		Model Number	Model Number			
12	24	Y-3T3D2L1224B	Y-3T3D2R1224B	535	+30	+110
12	30	Y-3T3D2L1230B	Y-3T3D2R1230B	542	+38	+138
16	24	Y-3T3D2L1624B	Y-3T3D2R1624B	661	+40	+147
16	30	Y-3T3D2L1630B	Y-3T3D2R1630B	687	+50	+184
20	24	Y-3T3D2L2024B	Y-3T3D2R2024B	606	+50	+184
20	30	Y-3T3D2L2030B	Y-3T3D2R2030B	659	+63	+230
24	24	Y-3T3D2L2424B	Y-3T3D2R2424B	647	+60	+220
24	30	Y-3T3D2L2430B	Y-3T3D2R2430B	710	+75	+275

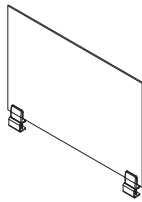

Left Hand

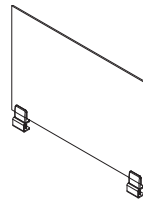

Right Hand

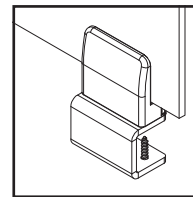

Under Surface Mount Clip

Specify

Notes

- Clips available in Metallic Silver only.
- Standard products for glass are always clear unless noted otherwise, other colors may be available upon special request (upcharges apply).

Glass Day-to-Day & Calibrate HAT Depth Territory Under Surface Mount Clip Screens

Material	Where Used	Screen Type	Sized For	Mount Type	Handedness
Glass 3/8"	Territory on Worksurface	Clip	Day-to-Day & Calibrate HAT Depth	Under Surface Mount	Left or Right

**GLASS 3/8" DAY-TO-DAY & CALIBRATE HAT DEPTH
TERRITORY UNDER SURFACE MOUNT CLIP SCREENS**

H	D	Left Hand	Right Hand	List	Tinted Glass	Frosted Glass
		Model Number	Model Number			
12	24	Y-4T3D2L1224B	Y-4T3D2R1224B	718	+30	+60
12	30	Y-4T3D2L1230B	Y-4T3D2R1230B	722	+38	+75
16	24	Y-4T3D2L1624B	Y-4T3D2R1624B	684	+40	+80
16	30	Y-4T3D2L1630B	Y-4T3D2R1630B	764	+50	+100
20	24	Y-4T3D2L2024B	Y-4T3D2R2024B	780	+50	+100
20	30	Y-4T3D2L2030B	Y-4T3D2R2030B	884	+63	+125
24	24	Y-4T3D2L2424B	Y-4T3D2R2424B	855	+60	+120
24	30	Y-4T3D2L2430B	Y-4T3D2R2430B	975	+75	+150

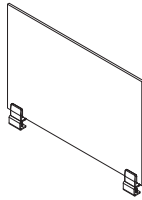

Left Hand

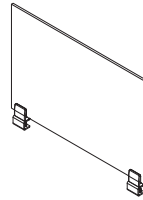

Right Hand

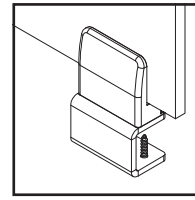

Under Surface Mount Clip

Specify

Notes

- Clips available in Metallic Silver only.
- Standard products for glass are always clear unless noted otherwise, other colors may be available upon special request (upcharges apply).

Lexan Day-to-Day & Calibrate HAT Depth Territory Freestanding Clip Screens

Material	Where Used	Screen Type	Sized For	Mount Type
Lexan 1/4"	Territory on Worksurface	Clip	Day-to-Day & Calibrate HAT Depth	Freestanding

LEXAN 1/4" DAY-TO-DAY & CALIBRATE HAT DEPTH TERRITORY FREESTANDING CLIP SCREENS WITHOUT CUT-OUTS

H	D	Model Number	List
12	24	Y-1T3D4U1224B	735
16	24	Y-1T3D4U1624B	786
20	24	Y-1T3D4U2024B	834
12	30	Y-1T3D4U1230B	771
16	30	Y-1T3D4U1630B	834
20	30	Y-1T3D4U2030B	897

LEXAN 1/4" DAY-TO-DAY & CALIBRATE HAT DEPTH TERRITORY FREESTANDING CLIP SCREENS WITH CUT-OUTS

H	D	Model Number	List
12	24	Y-1T3D4U1224A	735
16	24	Y-1T3D4U1624A	786
20	24	Y-1T3D4U2024A	834
12	30	Y-1T3D4U1230A	771
16	30	Y-1T3D4U1630A	834
20	30	Y-1T3D4U2030A	897

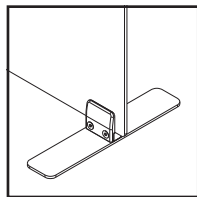
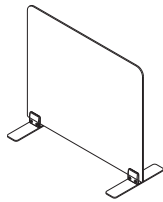

Freestanding Clip

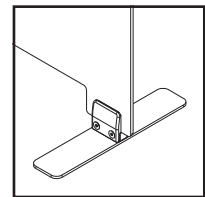
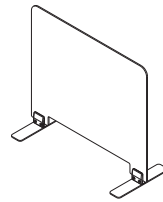

Freestanding Clip

Specify

Notes

- Clips available in Metallic Silver only.
- Lexan available only in clear.
- Non-marring feet measure 2 3/8" x 12".

Day-to-Day & Calibrate HAT Depth Territory Surface Mount Slimline Screens

Material	Where Used	Screen Type	Sized For	Mount Type
Fabric/Vinyl/Whiteboard/Laminate	Territory on Worksurface	Slimline	Day-to-Day & Calibrate HAT Depth	Freestanding

**DAY-TO-DAY & CALIBRATE HAT DEPTH
TERRITORY SURFACE MOUNT SLIMLINE SCREENS**

H	D	Model Number	List	Fabric Grade C	Fabric Grade D
12	24	Y-6T1D1U1224B	647	+7	+14
16	24	Y-6T1D1U1624B	715	+11	+22
20	24	Y-6T1D1U2024B	648	+15	+30
24	24	Y-6T1D1U2424B	693	+18	+36
28	24	Y-6T1D1U2824B	767	+21	+42
12	30	Y-6T1D1U1230B	555	+7	+14
16	30	Y-6T1D1U1630B	715	+11	+22
20	30	Y-6T1D1U2030B	787	+15	+30
24	30	Y-6T1D1U2430B	830	+18	+36
28	30	Y-6T1D1U2830B	912	+21	+42

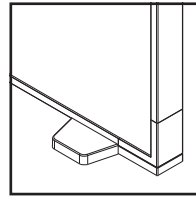
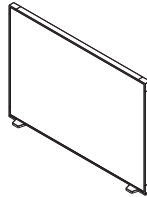

Surface Mount Slimline

Specify

- Paint Selection (Grade C +10)
- Fabric, Vinyl, Whiteboard or Laminate Selection

Notes

- Slimline screens may be fabric, vinyl, whiteboard or laminate on either side. Upcharges for Grade C and D are listed per side. Whiteboards are standard list and have no upcharge.
- Offered in all AIS paint finishes.

Day-to-Day & Calibrate HAT Depth Territory Under Surface Mount Slimline Screens

Material	Where Used	Screen Type	Sized For	Mount Type	Handedness
Fabric/Vinyl/Whiteboard/Laminate	Territory on Worksurface	Slimline	Day-to-Day & Calibrate HAT Depth	Under Surface Mount	Left or Right

**DAY-TO-DAY & CALIBRATE HAT DEPTH
TERRITORY UNDER SURFACE MOUNT SLIMLINE SCREENS**

H	D	Left Hand	Right Hand	List	Fabric Grade C	Fabric Grade D
		Model Number	Model Number			
12	24	T-TSHL1224	T-TSHR1224	555	+7	+14
16	24	T-TSHL1624	T-TSHR1624	604	+11	+22
20	24	T-TSHL2024	T-TSHR2024	648	+15	+30
24	24	T-TSHL2424	T-TSHR2424	693	+18	+36
28	24	T-TSHL2824	T-TSHR2824	767	+21	+42
12	30	T-TSHL1230	T-TSHR1230	647	+7	+14
16	30	T-TSHL1630	T-TSHR1630	715	+11	+22
20	30	T-TSHL2030	T-TSHR2030	787	+15	+30
24	30	T-TSHL2430	T-TSHR2430	830	+18	+36
28	30	T-TSHL2830	T-TSHR2830	912	+21	+42

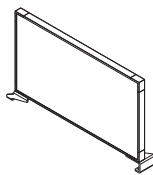

Left Hand

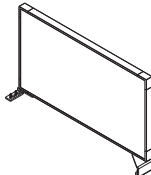

Right Hand

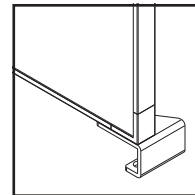

Under Surface Mount Slimline

Specify

- Paint Selection (Grade C +10)
- Fabric, Vinyl, Whiteboard or Laminate Selection

Notes

- Slimline screens may be fabric, vinyl, whiteboard or laminate on either side. Upcharges for Grade C and D are listed per side. Whiteboards are standard list and have no upcharge.
- Offered in all AIS paint finishes.

Screens Sized for Aloft & Benching HAT Depths

Lexan Aloft & Benching HAT Depth Territory Surface Mount Channel Screens

Material	Where Used	Screen Type	Sized For	Mount Type
Lexan 1/4"	Territory on Worksurface	Channel	Aloft & Benching HAT Depth	Surface Mount

LEXAN 1/4" ALOFT & BENCHING HAT DEPTH TERRITORY SURFACE MOUNT CHANNEL SCREENS

H	D	Model Number	List
12	24	Y-1T2E1U1224B	605
16	24	Y-1T2E1U1624B	655
20	24	Y-1T2E1U2024B	704
12	30	Y-1T2E1U1230B	642
16	30	Y-1T2E1U1630B	704
20	30	Y-1T2E1U2030B	766

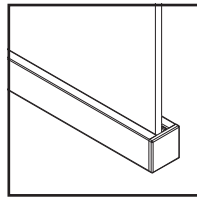
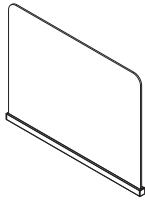

Surface Mount Channel

Specify

- Paint Selection (Grade C +10)

Notes

- Offered in all AIS paint finishes.
- Lexan available only in clear.

Glass Aloft & Benching HAT Depth Territory Surface Mount Channel Screens

Material	Where Used	Screen Type	Sized For	Mount Type
Glass 1/4"	Territory on Worksurface	Channel	Aloft & Benching HAT Depth	Surface Mount

GLASS 1/4" ALOFT & BENCHING HAT DEPTH TERRITORY SURFACE MOUNT CHANNEL SCREENS

H	D	Model Number	List	Tinted Glass	Frosted Glass
12	24	Y-3T2E1U1224B	665	+30	+110
12	30	Y-3T2E1U1230B	672	+38	+138
16	24	Y-3T2E1U1624B	791	+40	+147
16	30	Y-3T2E1U1630B	816	+50	+184
20	24	Y-3T2E1U2024B	736	+50	+184
20	30	Y-3T2E1U2030B	790	+63	+230
24	24	Y-3T2E1U2424B	777	+60	+220
24	30	Y-3T2E1U2430B	840	+75	+275

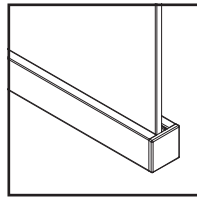
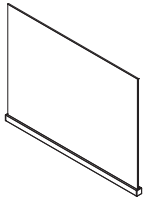

Surface Mount Channel

Specify

- Paint Selection (Grade C +10)

Notes

- Offered in all AIS paint finishes.
- Standard products for glass are always clear unless noted otherwise, other colors may be available upon special request (upcharges apply).

Glass Aloft & Benching HAT Depth Territory Surface Mount Channel Screens

Material	Where Used	Screen Type	Sized For	Mount Type
Glass 3/8"	Territory on Worksurface	Channel	Aloft & Benching HAT Depth	Surface Mount

GLASS 3/8" ALOFT & BENCHING HAT DEPTH TERRITORY SURFACE MOUNT CHANNEL SCREENS

H	D	Model Number	List	Tinted Glass	Frosted Glass
12	24	Y-4T2E1U1224B	847	+30	+60
12	30	Y-4T2E1U1230B	850	+38	+75
16	24	Y-4T2E1U1624B	814	+40	+80
16	30	Y-4T2E1U1630B	895	+50	+100
20	24	Y-4T2E1U2024B	911	+50	+100
20	30	Y-4T2E1U2030B	1,015	+63	+125
24	24	Y-4T2E1U2424B	985	+60	+120
24	30	Y-4T2E1U2430B	1,103	+75	+150

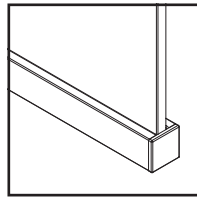
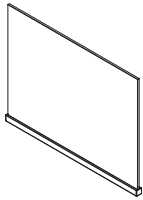

Surface Mount Channel

Specify

- Paint Selection (Grade C +10)

Notes

- Offered in all AIS paint finishes.
- Standard products for glass are always clear unless noted otherwise, other colors may be available upon special request (upcharges apply).

PET Aloft & Benching HAT Depth Territory Surface Mount Channel Screens

Material	Where Used	Screen Type	Sized For	Mount Type
PET	Territory on Worksurface	Channel	Aloft & Benching HAT Depth	Surface Mount

**PET ALOFT & BENCHING HAT DEPTH
TERRITORY SURFACE MOUNT CHANNEL SCREENS**

H	D	Model Number	List
12	24	Y-5T2E1U1224B	464
16	24	Y-5T2E1U1624B	485
20	24	Y-5T2E1U2024B	507
24	24	Y-5T2E1U2424B	531
28	24	Y-5T2E1U2824B	551
32	24	Y-5T2E1U3224B	574
12	30	Y-5T2E1U1230B	480
16	30	Y-5T2E1U1630B	507
20	30	Y-5T2E1U2030B	535
24	30	Y-5T2E1U2430B	563
28	30	Y-5T2E1U2830B	589
32	30	Y-5T2E1U3230B	616

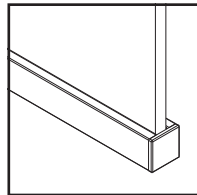
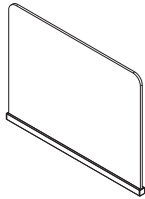

Surface Mount Channel

Specify

- Paint Selection (Grade C +10)
- Color Selection for PET - Lite Grey, Medium Grey, Tan or Vibrant Blue

Notes

- Offered in all AIS paint finishes.

Lexan Aloft & Benching HAT Depth Territory Under Surface Mount Channel Screens

Material	Where Used	Screen Type	Sized For	Mount Type	Handedness
Lexan 1/4"	Territory on Worksurface	Channel	Aloft & Benching HAT Depth	Under Surface Mount	Left or Right

**LEXAN 1/4" ALOFT & BENCHING HAT DEPTH
TERRITORY UNDER SURFACE MOUNT CHANNEL SCREENS**

H	D	Left Hand	Right Hand	List
		Model Number	Model Number	
12	24	Y-1T2E2L1224B	Y-1T2E2R1224B	735
16	24	Y-1T2E2L1624B	Y-1T2E2R1624B	786
20	24	Y-1T2E2L2024B	Y-1T2E2R2024B	834
12	30	Y-1T2E2L1230B	Y-1T2E2R1230B	771
16	30	Y-1T2E2L1630B	Y-1T2E2R1630B	834
20	30	Y-1T2E2L2030B	Y-1T2E2R2030B	897

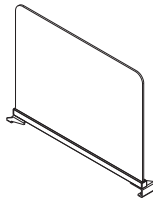

Left Hand

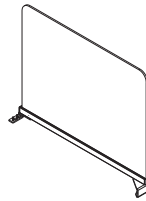

Right Hand

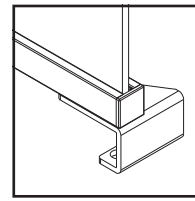

Under Surface Mount Channel

Specify

- Paint Selection (Grade C +10)

Notes

- Offered in all AIS paint finishes.
- Lexan available only in clear.

Glass Aloft & Benching HAT Depth Territory Under Surface Mount Channel Screens

Material	Where Used	Screen Type	Sized For	Mount Type	Handedness
Glass 1/4"	Territory on Worksurface	Channel	Aloft & Benching HAT Depth	Under Surface Mount	Left or Right

**GLASS 1/4" ALOFT & BENCHING HAT DEPTH
TERRITORY UNDER SURFACE MOUNT CHANNEL SCREENS**

H	D	Left Hand	Right Hand	List	Tinted Glass	Frosted Glass
		Model Number	Model Number			
12	24	Y-3T2E2L1224B	Y-3T2E2R1224B	665	+30	+110
12	30	Y-3T2E2L1230B	Y-3T2E2R1230B	672	+38	+138
16	24	Y-3T2E2L1624B	Y-3T2E2R1624B	791	+40	+147
16	30	Y-3T2E2L1630B	Y-3T2E2R1630B	816	+50	+184
20	24	Y-3T2E2L2024B	Y-3T2E2R2024B	736	+50	+184
20	30	Y-3T2E2L2030B	Y-3T2E2R2030B	790	+63	+230
24	24	Y-3T2E2L2424B	Y-3T2E2R2424B	777	+60	+220
24	30	Y-3T2E2L2430B	Y-3T2E2R2430B	840	+75	+275

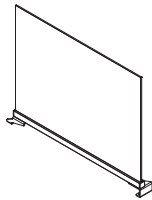

Left Hand

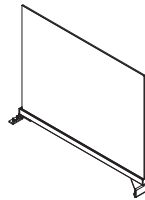

Right Hand

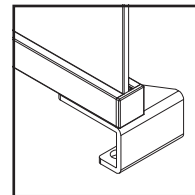

Under Surface Mount Channel

Specify

- Paint Selection (Grade C +10)

Notes

- Offered in all AIS paint finishes.
- Standard products for glass are always clear unless noted otherwise, other colors may be available upon special request (upcharges apply).

Glass Aloft & Benching HAT Depth Territory Under Surface Mount Channel Screens

Material	Where Used	Screen Type	Sized For	Mount Type	Handedness
Glass 3/8"	Territory on Worksurface	Channel	Aloft & Benching HAT Depth	Under Surface Mount	Left or Right

**GLASS 3/8" ALOFT & BENCHING HAT DEPTH
TERRITORY UNDER SURFACE MOUNT CHANNEL SCREENS**

H	D	Left Hand	Right Hand	List	Tinted Glass	Frosted Glass
		Model Number	Model Number			
12	24	Y-4T2E2L1224B	Y-4T2E2R1224B	847	+30	+60
12	30	Y-4T2E2L1230B	Y-4T2E2R1230B	850	+38	+75
16	24	Y-4T2E2L1624B	Y-4T2E2R1624B	814	+40	+80
16	30	Y-4T2E2L1630B	Y-4T2E2R1630B	895	+50	+100
20	24	Y-4T2E2L2024B	Y-4T2E2R2024B	911	+50	+100
20	30	Y-4T2E2L2030B	Y-4T2E2R2030B	1,015	+63	+125
24	24	Y-4T2E2L2424B	Y-4T2E2R2424B	985	+60	+120
24	30	Y-4T2E2L2430B	Y-4T2E2R2430B	1,103	+75	+150

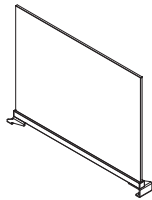

Left Hand

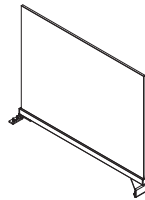

Right Hand

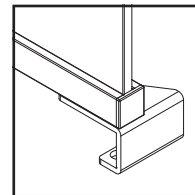

Under Surface Mount Channel

Specify

- Paint Selection (Grade C +10)

Notes

- Offered in all AIS paint finishes.
- Standard products for glass are always clear unless noted otherwise, other colors may be available upon special request (upcharges apply).

PET Aloft & Benching HAT Depth Territory Under Surface Mount Channel Screens

Material	Where Used	Screen Type	Sized For	Mount Type	Handedness
PET	Territory on Worksurface	Channel	Aloft & Benching HAT Depth	Under Surface Mount	Left or Right

**PET ALOFT & BENCHING HAT DEPTH
TERRITORY UNDER SURFACE MOUNT CHANNEL SCREENS**

H	D	Left Hand	Right Hand	List
		Model Number	Model Number	
12	24	Y-5T2E2L1224B	Y-5T2E2R1224B	593
16	24	Y-5T2E2L1624B	Y-5T2E2R1624B	615
20	24	Y-5T2E2L2024B	Y-5T2E2R2024B	638
24	24	Y-5T2E2L2424B	Y-5T2E2R2424B	659
28	24	Y-5T2E2L2824B	Y-5T2E2R2824B	682
32	24	Y-5T2E2L3224B	Y-5T2E2R3224B	704
12	30	Y-5T2E2L1230B	Y-5T2E2R1230B	610
16	30	Y-5T2E2L1630B	Y-5T2E2R1630B	638
20	30	Y-5T2E2L2030B	Y-5T2E2R2030B	665
24	30	Y-5T2E2L2430B	Y-5T2E2R2430B	693
28	30	Y-5T2E2L2830B	Y-5T2E2R2830B	720
32	30	Y-5T2E2L3230B	Y-5T2E2R3230B	747

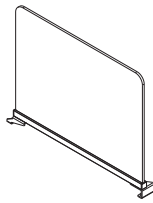

Left Hand

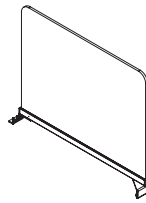

Right Hand

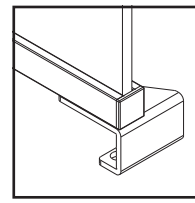

Under Surface Mount Channel

Specify

- Paint Selection (Grade C+10)
- Color Selection for PET - Lite Grey, Medium Grey, Tan or Vibrant Blue

Notes

- Offered in all AIS paint finishes.

Lexan Aloft & Benching HAT Depth Territory Surface Mount Clip Screens

Material	Where Used	Screen Type	Sized For	Mount Type
Lexan 1/4"	Territory on Worksurface	Clip	Aloft & Benching HAT Depth	Surface Mount

LEXAN 1/4" ALOFT & BENCHING HAT DEPTH TERRITORY SURFACE MOUNT CLIP SCREENS WITHOUT CUT-OUTS

H	D	Model Number	List
12	24	Y-1T3E1U1224B	605
16	24	Y-1T3E1U1624B	655
20	24	Y-1T3E1U2024B	704
12	30	Y-1T3E1U1230B	642
16	30	Y-1T3E1U1630B	704
20	30	Y-1T3E1U2030B	766

LEXAN 1/4" ALOFT & BENCHING HAT DEPTH TERRITORY SURFACE MOUNT CLIP SCREENS WITH CUT-OUTS

H	D	Model Number	List
12	24	Y-1T3E1U1224A	605
16	24	Y-1T3E1U1624A	655
20	24	Y-1T3E1U2024A	704
12	30	Y-1T3E1U1230A	642
16	30	Y-1T3E1U1630A	704
20	30	Y-1T3E1U2030A	766

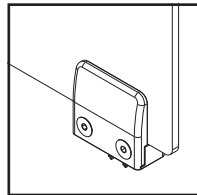
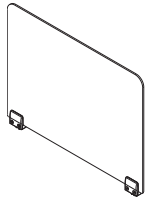

Surface Mount Clip

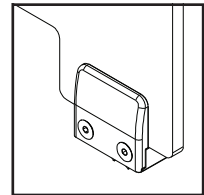
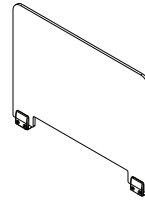

Surface Mount Clip

Specify

Notes

- Clips available in Metallic Silver only.
- Lexan available only in clear.

Glass Aloft & Benching HAT Depth Territory Surface Mount Clip Screens

Material	Where Used	Screen Type	Sized For	Mount Type
Glass 1/4"	Territory on Worksurface	Clip	Aloft & Benching HAT Depth	Surface Mount

GLASS 1/4" ALOFT & BENCHING HAT DEPTH TERRITORY SURFACE MOUNT CLIP SCREENS

H	D	Model Number	List	Tinted Glass	Frosted Glass
12	24	Y-3T3E1U1224B	535	+30	+110
12	30	Y-3T3E1U1230B	542	+38	+138
16	24	Y-3T3E1U1624B	661	+40	+147
16	30	Y-3T3E1U1630B	687	+50	+184
20	24	Y-3T3E1U2024B	606	+50	+184
20	30	Y-3T3E1U2030B	659	+63	+230
24	24	Y-3T3E1U2424B	647	+60	+220
24	30	Y-3T3E1U2430B	710	+75	+275

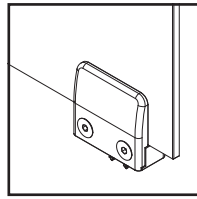
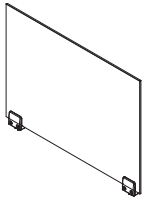

Surface Mount Clip

Specify

Notes

- Clips available in Metallic Silver only.
- Standard products for glass are always clear unless noted otherwise, other colors may be available upon special request (upcharges apply).

Glass Aloft & Benching HAT Depth Territory Surface Mount Clip Screens

Material	Where Used	Screen Type	Sized For	Mount Type
Glass 3/8"	Territory on Worksurface	Clip	Aloft & Benching HAT Depth	Surface Mount

GLASS 3/8" ALOFT & BENCHING HAT DEPTH TERRITORY SURFACE MOUNT CLIP SCREENS

H	D	Model Number	List	Tinted Glass	Frosted Glass
12	24	Y-4T3E1U1224B	718	+30	+60
12	30	Y-4T3E1U1230B	722	+38	+75
16	24	Y-4T3E1U1624B	684	+40	+80
16	30	Y-4T3E1U1630B	764	+50	+100
20	24	Y-4T3E1U2024B	780	+50	+100
20	30	Y-4T3E1U2030B	884	+63	+125
24	24	Y-4T3E1U2424B	855	+60	+120
24	30	Y-4T3E1U2430B	975	+75	+150

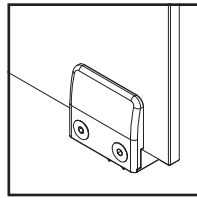
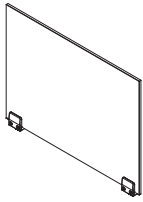

Surface Mount Clip

Specify

Notes

- Clips available in Metallic Silver only.
- Standard products for glass are always clear unless noted otherwise, other colors may be available upon special request (upcharges apply).

Lexan Aloft & Benching HAT Depth Territory Under Surface Mount Clip Screens

Material	Where Used	Screen Type	Sized For	Mount Type	Handedness
Lexan 1/4"	Territory on Worksurface	Clip	Aloft & Benching HAT Depth	Under Surface Mount	Left or Right

**LEXAN 1/4" ALOFT & BENCHING HAT DEPTH
TERRITORY UNDER SURFACE MOUNT CLIP SCREENS WITHOUT CUT-OUTS**

H	D	Left Hand	Right Hand	List
		Model Number	Model Number	
12	24	Y-1T3E2L1224B	Y-1T3E2R1224B	605
16	24	Y-1T3E2L1624B	Y-1T3E2R1624B	655
20	24	Y-1T3E2L2024B	Y-1T3E2R2024B	704
12	30	Y-1T3E2L1230B	Y-1T3E2R1230B	642
16	30	Y-1T3E2L1630B	Y-1T3E2R1630B	704
20	30	Y-1T3E2L2030B	Y-1T3E2R2030B	766

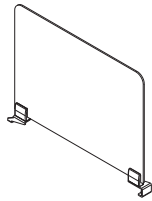

Left Hand

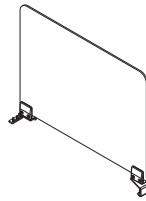

Right Hand

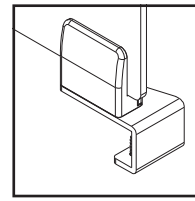

Under Surface Mount Clip

Specify

Notes

- Clips available in Metallic Silver only.
- Lexan available only in clear.

Lexan Aloft & Benching HAT Depth Territory Under Surface Mount Clip Screens

Material	Where Used	Screen Type	Sized For	Mount Type	Handedness
Lexan 1/4"	Territory on Worksurface	Clip	Aloft & Benching HAT Depth	Under Surface Mount	Left or Right

**LEXAN 1/4" ALOFT & BENCHING HAT DEPTH
TERRITORY UNDER SURFACE MOUNT CLIP SCREENS WITH CUT-OUTS**

H	D	Actual D	Left Hand	Right Hand	List
			Model Number	Model Number	
12	24	23	Y-1T3E2L1224A	Y-1T3E2R1224A	605
16	24	23	Y-1T3E2L1624A	Y-1T3E2R1624A	655
20	24	23	Y-1T3E2L2024A	Y-1T3E2R2024A	704
12	30	29	Y-1T3E2L1230A	Y-1T3E2R1230A	642
16	30	29	Y-1T3E2L1630A	Y-1T3E2R1630A	704
20	30	29	Y-1T3E2L2030A	Y-1T3E2R2030A	766

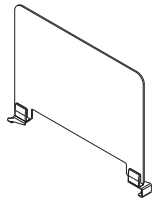

Left Hand

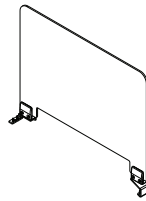

Right Hand

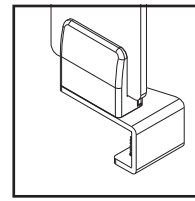

Under Surface Mount Clip

Specify

Notes

- Clips available in Metallic Silver only.
- Lexan available only in clear.

Glass Aloft & Benching HAT Depth Territory Under Surface Mount Clip Screens

Material	Where Used	Screen Type	Sized For	Mount Type	Handedness
Glass 1/4"	Territory on Worksurface	Clip	Aloft & Benching HAT Depth	Under Surface Mount	Left or Right

**GLASS 1/4" ALOFT & BENCHING HAT DEPTH
TERRITORY UNDER SURFACE MOUNT CLIP SCREENS**

H	D	Left Hand	Right Hand	List	Tinted Glass	Frosted Glass
		Model Number	Model Number			
12	24	Y-3T3E2L1224B	Y-3T3E2R1224B	535	+30	+110
12	30	Y-3T3E2L1230B	Y-3T3E2R1230B	542	+38	+138
16	24	Y-3T3E2L1624B	Y-3T3E2R1624B	661	+40	+147
16	30	Y-3T3E2L1630B	Y-3T3E2R1630B	687	+50	+184
20	24	Y-3T3E2L2024B	Y-3T3E2R2024B	606	+50	+184
20	30	Y-3T3E2L2030B	Y-3T3E2R2030B	659	+63	+230
24	24	Y-3T3E2L2424B	Y-3T3E2R2424B	647	+60	+220
24	30	Y-3T3E2L2430B	Y-3T3E2R2430B	710	+75	+275

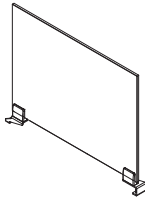

Left Hand

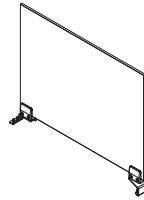

Right Hand

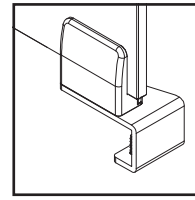

Under Surface Mount Clip

Specify

Notes

- Clips available in Metallic Silver only.
- Standard products for glass are always clear unless noted otherwise, other colors may be available upon special request (upcharges apply).

Glass Aloft & Benching HAT Depth Territory Under Surface Mount Clip Screens

Material	Where Used	Screen Type	Sized For	Mount Type	Handedness
Glass 3/8"	Territory on Worksurface	Clip	Aloft & Benching HAT Depth	Under Surface Mount	Left or Right

GLASS 3/8" ALOFT & BENCHING HAT DEPTH TERRITORY UNDER SURFACE MOUNT CLIP SCREENS

H	D	Left Hand	Right Hand	List	Tinted Glass	Frosted Glass
		Model Number	Model Number			
12	24	Y-4T3E2L1224B	Y-4T3E2R1224B	718	+30	+60
12	30	Y-4T3E2L1230B	Y-4T3E2R1230B	722	+38	+75
16	24	Y-4T3E2L1624B	Y-4T3E2R1624B	684	+40	+80
16	30	Y-4T3E2L1630B	Y-4T3E2R1630B	764	+50	+100
20	24	Y-4T3E2L2024B	Y-4T3E2R2024B	780	+50	+100
20	30	Y-4T3E2L2030B	Y-4T3E2R2030B	884	+63	+125
24	24	Y-4T3E2L2424B	Y-4T3E2R2424B	855	+60	+120
24	30	Y-4T3E2L2430B	Y-4T3E2R2430B	975	+75	+150

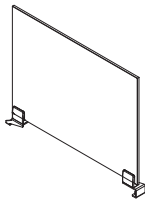

Left Hand

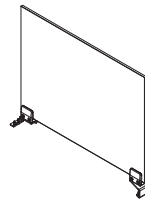

Right Hand

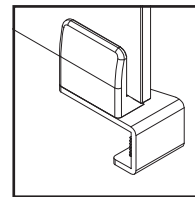

Under Surface Mount Clip

Specify

Notes

- Clips available in Metallic Silver only.
- Standard products for glass are always clear unless noted otherwise, other colors may be available upon special request (upcharges apply).

Lexan Aloft & Benching HAT Depth Territory Freestanding Clip Screens

Material	Where Used	Screen Type	Sized For	Mount Type
Lexan 1/4"	Territory on Worksurface	Clip	Aloft & Benching HAT Depth	Freestanding

LEXAN 1/4" ALOFT & BENCHING HAT DEPTH TERRITORY FREESTANDING CLIP SCREENS WITHOUT CUT-OUTS

H	D	Model Number	List
12	24	Y-1T3E4U1224B	735
16	24	Y-1T3E4U1624B	786
20	24	Y-1T3E4U2024B	834
12	30	Y-1T3E4U1230B	771
16	30	Y-1T3E4U1630B	834
20	30	Y-1T3E4U2030B	897

LEXAN 1/4" ALOFT & BENCHING HAT DEPTH TERRITORY FREESTANDING CLIP SCREENS WITH CUT-OUTS

H	D	Model Number	List
12	24	Y-1T3E4U1224A	735
16	24	Y-1T3E4U1624A	786
20	24	Y-1T3E4U2024A	834
12	30	Y-1T3E4U1230A	771
16	30	Y-1T3E4U1630A	834
20	30	Y-1T3E4U2030A	897

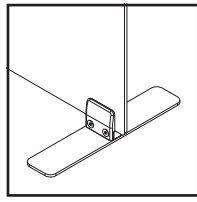
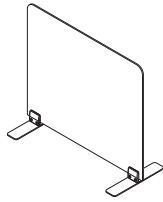

Freestanding Clip

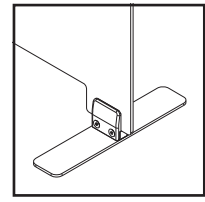
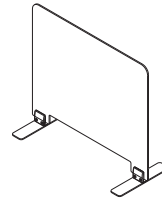

Freestanding Clip

Specify

Notes

- Clips available in Metallic Silver only.
- Lexan available only in clear.
- Non-marring feet measure 2 3/8" x 12".

PET Aloft & Benching HAT Depth Territory Surface Mount Lite Screens

Material	Where Used	Screen Type	Sized For	Mount Type
PET	Territory on Worksurface	Lite	Aloft & Benching HAT Depth	Surface Mount

**PET ALOFT & BENCHING HAT DEPTH
TERRITORY SURFACE MOUNT LITE SCREENS**

H	D	Model Number	List
12	24	Y-5T4E1U1224B	494
16	24	Y-5T4E1U1624B	506
20	24	Y-5T4E1U2024B	518
24	24	Y-5T4E1U2424B	533
28	24	Y-5T4E1U2824B	544
32	24	Y-5T4E1U3224B	557
12	30	Y-5T4E1U1230B	504
16	30	Y-5T4E1U1630B	518
20	30	Y-5T4E1U2030B	535
24	30	Y-5T4E1U2430B	549
28	30	Y-5T4E1U2830B	567
32	30	Y-5T4E1U3230B	583

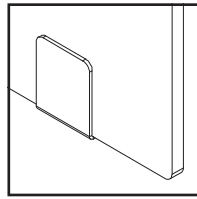
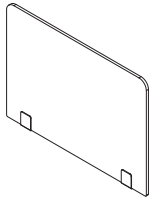

Surface Mount Lite

Specify

- Paint Selection (Grade C +10)
- Color Selection for PET - Lite Grey, Medium Grey, Tan or Vibrant Blue

Notes

- PET Territory Screens are designed to mount to AIS worksurfaces. Specify based on nominal size for the desired system. Order screens that correspond to worksurface width.
- PET screen inserts are 1/2" (12mm) thick.

PET Aloft & Benching HAT Depth Territory Surface Under Mount Lite Screens

Material	Where Used	Screen Type	Sized For	Mount Type	Handedness
PET	Territory on Worksurface	Lite	Aloft & Benching HAT Depth	Under Surface Mount	Aloft Non-Handed

PET ALOFT & BENCHING HAT DEPTH TERRITORY UNDER SURFACE MOUNT LITE SCREENS (ALOFT NON-HANDED)

H	D	Model Number	List
12	24	Y-5T4E2A1224B	494
16	24	Y-5T4E2A1624B	506
20	24	Y-5T4E2A2024B	518
24	24	Y-5T4E2A2424B	533
28	24	Y-5T4E2A2824B	544
32	24	Y-5T4E2A3224B	557
12	30	Y-5T4E2A1230B	504
16	30	Y-5T4E2A1630B	518
20	30	Y-5T4E2A2030B	535
24	30	Y-5T4E2A2430B	549
28	30	Y-5T4E2A2830B	567
32	30	Y-5T4E2A3230B	583

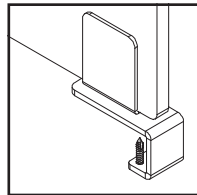
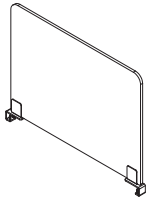

Under Surface Mount Lite

Specify

- Paint Selection (Grade C +10)
- Color Selection for PET - Lite Grey, Medium Grey, Tan or Vibrant Blue

Notes

- PET Territory Screens are designed to mount to AIS worksurfaces. Specify based on nominal size for the desired system. Order screens that correspond to worksurface width.
- PET screen inserts are 1/2" (12mm) thick.

PET Aloft & Benching HAT Depth Territory Surface Under Mount Lite Screens

Material	Where Used	Screen Type	Sized For	Mount Type	Handedness
PET	Territory on Worksurface	Lite	Aloft & Benching HAT Depth	Under Surface Mount	Benching Non-Handed

**PET ALOFT & BENCHING HAT DEPTH TERRITORY
UNDER SURFACE MOUNT LITE SCREENS (BENCHING NON-HANDED)**

H	D	Model Number	List
12	24	Y-5T4E2B1224B	494
16	24	Y-5T4E2B1624B	506
20	24	Y-5T4E2B2024B	518
24	24	Y-5T4E2B2424B	533
28	24	Y-5T4E2B2824B	544
32	24	Y-5T4E2B3224B	557
12	30	Y-5T4E2B1230B	504
16	30	Y-5T4E2B1630B	518
20	30	Y-5T4E2B2030B	535
24	30	Y-5T4E2B2430B	549
28	30	Y-5T4E2B2830B	567
32	30	Y-5T4E2B3230B	583

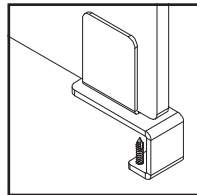
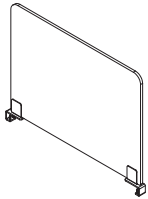

Under Surface Mount Lite

Specify

- Paint Selection (Grade C +10)
- Color Selection for PET - Lite Grey, Medium Grey, Tan or Vibrant Blue

Notes

- PET Territory Screens are designed to mount to AIS worksurfaces. Specify based on nominal size for the desired system. Order screens that correspond to worksurface width.
- PET screen inserts are 1/2" (12mm) thick.

PET Aloft & Benching HAT Depth Territory Freestanding Lite Screens

Material	Where Used	Screen Type	Sized For	Mount Type
PET	Territory on Worksurface	Lite	Aloft & Benching HAT Depth	Freestanding

**PET ALOFT & BENCHING HAT DEPTH
TERRITORY FREESTANDING LITE SCREENS**

H	D	Model Number	List
12	24	Y-5T4E4U1224B	624
16	24	Y-5T4E4U1624B	637
20	24	Y-5T4E4U2024B	648
24	24	Y-5T4E4U2424B	663
28	24	Y-5T4E4U2824B	674
32	24	Y-5T4E4U3224B	687
12	30	Y-5T4E4U1230B	634
16	30	Y-5T4E4U1630B	648
20	30	Y-5T4E4U2030B	665
24	30	Y-5T4E4U2430B	680
28	30	Y-5T4E4U2830B	697
32	30	Y-5T4E4U3230B	713

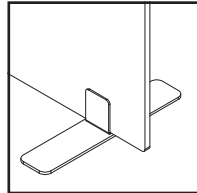
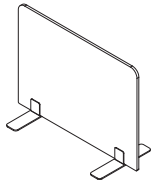

Freestanding Lite

Specify

- Paint Selection (Grade C +10)
- Color Selection for PET - Lite Grey, Medium Grey, Tan or Vibrant Blue

Notes

- PET Territory Screens are designed to mount to AIS worksurfaces. Specify based on nominal size for the desired system. Order screens that correspond to worksurface width.
- PET screen inserts are 1/2" (12mm) thick.
- Non-marring feet measure 2 3/8" x 12".

Aloft & Benching HAT Depth Territory Surface Mount Slimline Screens

Material	Where Used	Screen Type	Sized For	Mount Type
Fabric/Vinyl/Whiteboard/Laminate	Territory on Worksurface	Slimline	Aloft & Benching HAT Depth	Surface Mount

**ALOFT & BENCHING HAT DEPTH
TERRITORY SURFACE MOUNT SLIMLINE SCREENS**

H	D	Model Number	List	Fabric Grade C	Fabric Grade D
12	24	Y-6T1E1U1224B	647	+7	+14
16	24	Y-6T1E1U1624B	715	+11	+22
20	24	Y-6T1E1U2024B	648	+15	+30
24	24	Y-6T1E1U2424B	693	+18	+36
28	24	Y-6T1E1U2824B	767	+21	+42
12	30	Y-6T1E1U1230B	555	+7	+14
16	30	Y-6T1E1U1630B	715	+11	+22
20	30	Y-6T1E1U2030B	787	+15	+30
24	30	Y-6T1E1U2430B	830	+18	+36
28	30	Y-6T1E1U2830B	912	+21	+42

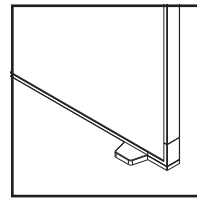
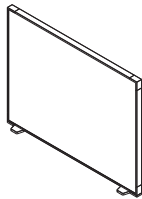

Surface Mount Slimline

Specify

- Paint Selection (Grade C +10)
- Fabric, Vinyl, Whiteboard or Laminate Selection

Notes

- Slimline screens may be fabric, vinyl, whiteboard or laminate on either side. Upcharges for Grade C and D are listed per side. Whiteboards are standard list and have no upcharge.
- Offered in all AIS paint finishes.

Aloft & Benching HAT Depth Territory Under Surface Mount Slimline Screens

Material	Where Used	Screen Type	Sized For	Mount Type	Handedness
Fabric/Vinyl/Whiteboard/Laminate	Territory on Worksurface	Slimline	Aloft & Benching HAT Depth	Under Surface Mount	Left or Right

**ALOFT & BENCHING HAT DEPTH
TERRITORY UNDER SURFACE MOUNT SLIMLINE SCREENS**

H	D	Left Hand	Right Hand	List	Fabric Grade C	Fabric Grade D
		Model Number	Model Number			
12	24	B-TSTWL1224	B-TSTWR1224	555	+7	+14
16	24	B-TSTWL1624	B-TSTWR1624	604	+11	+22
20	24	B-TSTWL2024	B-TSTWR2024	648	+15	+30
24	24	B-TSTWL2424	B-TSTWR2424	761	+18	+36
28	24	B-TSTWL2824	B-TSTWR2824	767	+21	+42
12	30	B-TSTWL1230	B-TSTWR1230	647	+7	+14
16	30	B-TSTWL1630	B-TSTWR1630	715	+11	+22
20	30	B-TSTWL2030	B-TSTWR2030	787	+15	+30
24	30	B-TSTWL2430	B-TSTWR2430	830	+18	+36
28	30	B-TSTWL2830	B-TSTWR2830	912	+21	+42

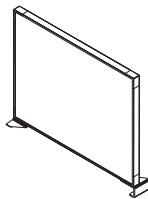

Left Hand

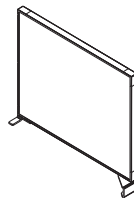

Right Hand

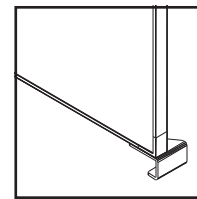

Under Surface Mount Slimline

Specify

- Paint Selection (Grade C +10)
- Fabric, Vinyl, Whiteboard or Laminate Selection

Notes

- Slimline screens may be fabric, vinyl, whiteboard or laminate on either side. Upcharges for Grade C and D are listed per side. Whiteboards are standard list and have no upcharge.
- Offered in all AIS paint finishes.

Screens Sized for Oxygen Worksurface Depths

Lexan Oxygen Worksurface Depth Territory Surface Mount Channel Screens

Material	Where Used	Screen Type	Sized For	Mount Type
Lexan 1/4"	Territory on Worksurface	Channel	Oxygen Worksurface Depth	Surface Mount

LEXAN 1/4" OXYGEN WORKSURFACE DEPTH TERRITORY SURFACE MOUNT CHANNEL SCREENS

H	D	Model Number	List
12	24	Y-1T2F1U1224B	605
16	24	Y-1T2F1U1624B	655
20	24	Y-1T2F1U2024B	704
12	30	Y-1T2F1U1230B	642
16	30	Y-1T2F1U1630B	704
20	30	Y-1T2F1U2030B	766

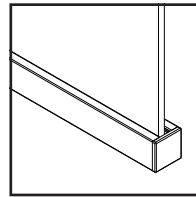
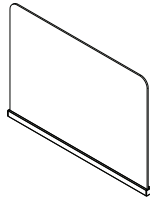

Surface Mount Channel

Specify

- Paint Selection (Grade C +10)

Notes

- Offered in all AIS paint finishes.
- Lexan available only in clear.

Glass Oxygen Worksurface Depth Territory Surface Mount Channel Screens

Material	Where Used	Screen Type	Sized For	Mount Type
Glass 1/4"	Territory on Worksurface	Channel	Oxygen Worksurface Depth	Surface Mount

GLASS 1/4" OXYGEN WORKSURFACE DEPTH TERRITORY SURFACE MOUNT CHANNEL SCREENS

H	D	Model Number	List	Tinted Glass	Frosted Glass
12	24	Y-3T2F1U1224B	665	+30	+110
16	24	Y-3T2F1U1624B	791	+40	+147
20	24	Y-3T2F1U2024B	736	+50	+184
24	24	Y-3T2F1U2424B	777	+60	+220
12	30	Y-3T2F1U1230B	672	+38	+138
16	30	Y-3T2F1U1630B	816	+50	+184
20	30	Y-3T2F1U2030B	790	+63	+230
24	30	Y-3T2F1U2430B	840	+75	+275

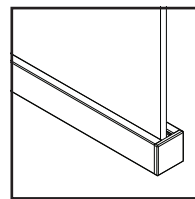
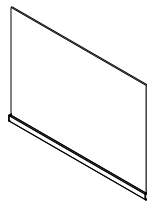

Surface Mount Channel

Specify

- Paint Selection (Grade C +10)

Notes

- Offered in all AIS paint finishes.
- Standard products for glass are always clear unless noted otherwise, other colors may be available upon special request (upcharges apply).

Glass Oxygen Worksurface Depth Territory Surface Mount Channel Screens

Material	Where Used	Screen Type	Sized For	Mount Type
Glass 3/8"	Territory on Worksurface	Channel	Oxygen Worksurface Depth	Surface Mount

GLASS 3/8" OXYGEN WORKSURFACE DEPTH TERRITORY SURFACE MOUNT CHANNEL SCREENS

H	D	Model Number	List	Tinted Glass	Frosted Glass
12	24	Y-4T2F1U1224B	847	+30	+60
16	24	Y-4T2F1U1624B	814	+40	+80
20	24	Y-4T2F1U2024B	911	+50	+100
24	24	Y-4T2F1U2424B	985	+60	+120
12	30	Y-4T2F1U1230B	850	+38	+75
16	30	Y-4T2F1U1630B	895	+50	+100
20	30	Y-4T2F1U2030B	1,015	+63	+125
24	30	Y-4T2F1U2430B	1,103	+75	+150

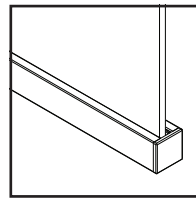
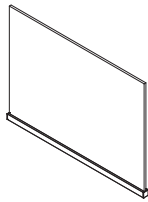

Surface Mount Channel

Specify

- Paint Selection (Grade C +10)

Notes

- Offered in all AIS paint finishes.
- Standard products for glass are always clear unless noted otherwise, other colors may be available upon special request (upcharges apply).

PET Oxygen Worksurface Depth Territory Surface Mount Channel Screens

Material	Where Used	Screen Type	Sized For	Mount Type
PET	Territory on Worksurface	Channel	Oxygen Worksurface Depth	Surface Mount

**PET OXYGEN WORKSURFACE DEPTH
TERRITORY SURFACE MOUNT CHANNEL SCREENS**

H	D	Model Number	List
12	24	Y-5T2F1U1224B	464
16	24	Y-5T2F1U1624B	485
20	24	Y-5T2F1U2024B	507
24	24	Y-5T2F1U2424B	531
28	24	Y-5T2F1U2824B	551
32	24	Y-5T2F1U3224B	574
12	30	Y-5T2F1U1230B	480
16	30	Y-5T2F1U1630B	507
20	30	Y-5T2F1U2030B	535
24	30	Y-5T2F1U2430B	563
28	30	Y-5T2F1U2830B	589
32	30	Y-5T2F1U3230B	616

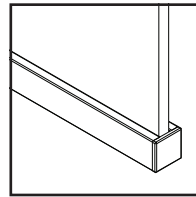
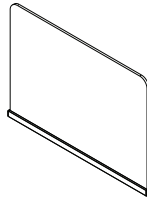

Surface Mount Channel

Specify

- Paint Selection (Grade C +10)
- Color Selection for PET - Lite Grey, Medium Grey, Tan or Vibrant Blue

Notes

- Offered in all AIS paint finishes.

Lexan Oxygen Worksurface Depth Territory Under Surface Mount Channel Screens

Material	Where Used	Screen Type	Sized For	Mount Type	Handedness
Lexan 1/4"	Territory on Worksurface	Channel	Oxygen Worksurface Depth	Under Surface Mount	Left, Right or Shared

**LEXAN 1/4" OXYGEN WORKSURFACE DEPTH
TERRITORY UNDER SURFACE MOUNT CHANNEL SCREENS**

H	D	Left Hand	Right Hand	Shared	List
		Model Number	Model Number	Model Number	
12	24	Y-1T2F2L1224B	Y-1T2F2R1224B	Y-1T2F2S1224B	735
16	24	Y-1T2F2L1624B	Y-1T2F2R1624B	Y-1T2F2S1624B	786
20	24	Y-1T2F2L2024B	Y-1T2F2R2024B	Y-1T2F2S2024B	834
12	30	Y-1T2F2L1230B	Y-1T2F2R1230B	Y-1T2F2S1230B	771
16	30	Y-1T2F2L1630B	Y-1T2F2R1630B	Y-1T2F2S1630B	834
20	30	Y-1T2F2L2030B	Y-1T2F2R2030B	Y-1T2F2S2030B	897

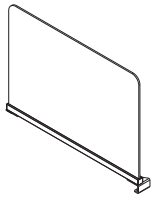

Left Hand

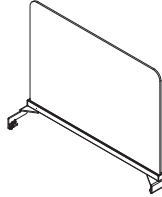

Right Hand

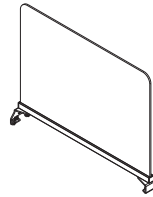

Shared

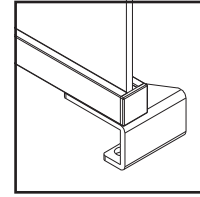

Under Surface Mount Channel

Specify

- Paint Selection (Grade C +10)

Notes

- Offered in all AIS paint finishes.
- Lexan available only in clear.

Glass Oxygen Worksurface Depth Territory Under Surface Mount Channel Screens

Material	Where Used	Screen Type	Sized For	Mount Type	Handedness
Glass 1/4"	Territory on Worksurface	Channel	Oxygen Worksurface Depth	Under Surface Mount	Left, Right or Shared

GLASS 1/4" OXYGEN WORKSURFACE DEPTH TERRITORY UNDER SURFACE MOUNT CHANNEL SCREENS

H	D	Left Hand	Right Hand	Shared	List	Tinted Glass	Frosted Glass
		Model Number	Model Number	Model Number			
12	24	Y-3T2F2L1224B	Y-3T2F2R1224B	Y-3T2F2S1224B	665	+30	+110
12	30	Y-3T2F2L1230B	Y-3T2F2R1230B	Y-3T2F2S1230B	672	+38	+138
16	24	Y-3T2F2L1624B	Y-3T2F2R1624B	Y-3T2F2S1624B	791	+40	+147
16	30	Y-3T2F2L1630B	Y-3T2F2R1630B	Y-3T2F2S1630B	816	+50	+184
20	24	Y-3T2F2L2024B	Y-3T2F2R2024B	Y-3T2F2S2024B	736	+50	+184
20	30	Y-3T2F2L2030B	Y-3T2F2R2030B	Y-3T2F2S2030B	790	+63	+230
24	24	Y-3T2F2L2424B	Y-3T2F2R2424B	Y-3T2F2S2424B	777	+60	+220
24	30	Y-3T2F2L2430B	Y-3T2F2R2430B	Y-3T2F2S2430B	840	+75	+275

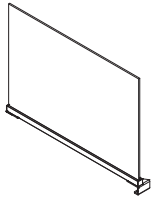

Left Hand

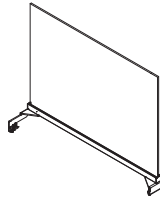

Right Hand

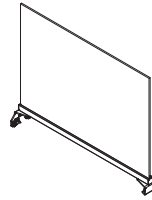

Shared

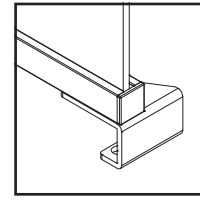

Under Surface Mount Channel

Specify

- Paint Selection (Grade C +10)

Notes

- Offered in all AIS paint finishes.
- Standard products for glass are always clear unless noted otherwise, other colors may be available upon special request (upcharges apply).

Glass Oxygen Worksurface Depth Territory Under Surface Mount Channel Screens

Material	Where Used	Screen Type	Sized For	Mount Type	Handedness
Glass 3/8"	Territory on Worksurface	Channel	Oxygen Worksurface Depth	Under Surface Mount	Left, Right or Shared

**GLASS 3/8" OXYGEN WORKSURFACE DEPTH
TERRITORY UNDER SURFACE MOUNT CHANNEL SCREENS**

H	D	Left Hand	Right Hand	Shared	List	Tinted Glass	Frosted Glass
		Model Number	Model Number	Model Number			
12	24	Y-4T2F2L1224B	Y-4T2F2R1224B	Y-4T2F2S1224B	847	+30	+60
12	30	Y-4T2F2L1230B	Y-4T2F2R1230B	Y-4T2F2S1230B	850	+38	+75
16	24	Y-4T2F2L1624B	Y-4T2F2R1624B	Y-4T2F2S1624B	814	+40	+80
16	30	Y-4T2F2L1630B	Y-4T2F2R1630B	Y-4T2F2S1630B	895	+50	+100
20	24	Y-4T2F2L2024B	Y-4T2F2R2024B	Y-4T2F2S2024B	911	+50	+100
20	30	Y-4T2F2L2030B	Y-4T2F2R2030B	Y-4T2F2S2030B	1,015	+63	+125
24	24	Y-4T2F2L2424B	Y-4T2F2R2424B	Y-4T2F2S2424B	985	+60	+120
24	30	Y-4T2F2L2430B	Y-4T2F2R2430B	Y-4T2F2S2430B	1,103	+75	+150

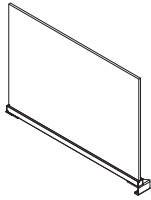

Left Hand

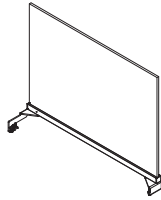

Right Hand

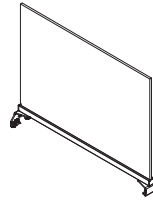

Shared

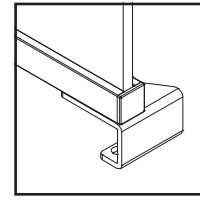

Under Surface Mount Channel

Specify

• Paint Selection (Grade C +10)

Notes

- Offered in all AIS paint finishes.
- Standard products for glass are always clear unless noted otherwise, other colors may be available upon special request (upcharges apply).

PET Oxygen Worksurface Depth Territory Under Surface Mount Channel Screens

Material	Where Used	Screen Type	Sized For	Mount Type	Handedness
PET	Territory on Worksurface	Channel	Oxygen Worksurface Depth	Under Surface Mount	Left, Right or Shared

PET OXYGEN WORKSURFACE DEPTH TERRITORY UNDER SURFACE MOUNT CHANNEL SCREENS

H	D	Left Hand	Right Hand	Shared	List
		Model Number	Model Number	Model Number	
12	24	Y-5T2F2L1224B	Y-5T2F2R1224B	Y-5T2F2S1224B	593
16	24	Y-5T2F2L1624B	Y-5T2F2R1624B	Y-5T2F2S1624B	615
20	24	Y-5T2F2L2024B	Y-5T2F2R2024B	Y-5T2F2S2024B	638
24	24	Y-5T2F2L2424B	Y-5T2F2R2424B	Y-5T2F2S2424B	659
28	24	Y-5T2F2L2824B	Y-5T2F2R2824B	Y-5T2F2S2824B	682
32	24	Y-5T2F2L3224B	Y-5T2F2R3224B	Y-5T2F2S3224B	704
12	30	Y-5T2F2L1230B	Y-5T2F2R1230B	Y-5T2F2S1230B	610
16	30	Y-5T2F2L1630B	Y-5T2F2R1630B	Y-5T2F2S1630B	638
20	30	Y-5T2F2L2030B	Y-5T2F2R2030B	Y-5T2F2S2030B	665
24	30	Y-5T2F2L2430B	Y-5T2F2R2430B	Y-5T2F2S2430B	693
28	30	Y-5T2F2L2830B	Y-5T2F2R2830B	Y-5T2F2S2830B	720
32	30	Y-5T2F2L3230B	Y-5T2F2R3230B	Y-5T2F2S3230B	747

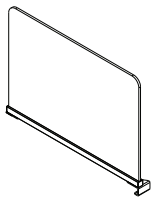

Left Hand

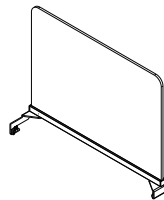

Right Hand

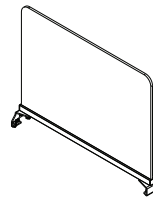

Shared

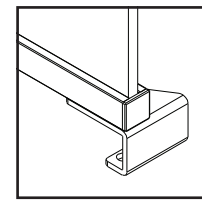

Under Surface Mount Channel

Specify

- Paint Selection (Grade C +10)
- Color Selection for PET - Lite Grey, Medium Grey, Tan or Vibrant Blue

Notes

- Offered in all AIS paint finishes.

Lexan Oxygen Worksurface Depth Territory Surface Mount Clip Screens

Material	Where Used	Screen Type	Sized For	Mount Type
Lexan 1/4"	Territory on Worksurface	Clip	Oxygen Worksurface Depth	Surface Mount

LXAN 1/4" OXYGEN WORKSURFACE DEPTH TERRITORY SURFACE MOUNT CLIP SCREENS

H	D	Model Number	List
12	24	Y-1T3F1U1224B	605
16	24	Y-1T3F1U1624B	655
20	24	Y-1T3F1U2024B	704
12	30	Y-1T3F1U1230B	642
16	30	Y-1T3F1U1630B	704
20	30	Y-1T3F1U2030B	766

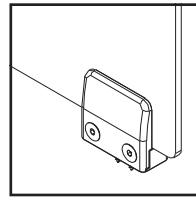
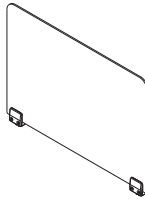

Surface Mount Clip

Specify

Notes

- Clips available in Metallic Silver only.
- Lexan available only in clear.

Glass Oxygen Worksurface Depth Territory Surface Mount Clip Screens

Material	Where Used	Screen Type	Sized For	Mount Type
Glass 1/4"	Territory on Worksurface	Clip	Oxygen Worksurface Depth	Surface Mount

GLASS 1/4" OXYGEN WORKSURFACE DEPTH TERRITORY SURFACE MOUNT CLIP SCREENS

H	D	Model Number	List	Tinted Glass	Frosted Glass
12	24	Y-3T3F1U1224B	535	+30	+110
12	30	Y-3T3F1U1230B	542	+38	+138
16	24	Y-3T3F1U1624B	661	+40	+147
16	30	Y-3T3F1U1630B	687	+50	+184
20	24	Y-3T3F1U2024B	606	+50	+184
20	30	Y-3T3F1U2030B	659	+63	+230
24	24	Y-3T3F1U2424B	647	+60	+220
24	30	Y-3T3F1U2430B	710	+75	+275

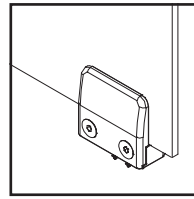
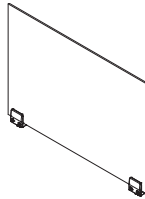

Surface Mount Clip

Specify

Notes

- Clips available in Metallic Silver only.
- Standard products for glass are always clear unless noted otherwise, other colors may be available upon special request (upcharges apply).

Glass Oxygen Worksurface Depth Territory Surface Mount Clip Screens

Material	Where Used	Screen Type	Sized For	Mount Type
Glass 3/8"	Territory on Worksurface	Clip	Oxygen Worksurface Depth	Surface Mount

GLASS 3/8" OXYGEN WORKSURFACE DEPTH TERRITORY SURFACE MOUNT CLIP SCREENS

H	D	Model Number	List	Tinted Glass	Frosted Glass
12	24	Y-4T3F1U1224B	718	+30	+60
12	30	Y-4T3F1U1230B	722	+38	+75
16	24	Y-4T3F1U1624B	684	+40	+80
16	30	Y-4T3F1U1630B	764	+50	+100
20	24	Y-4T3F1U2024B	780	+50	+100
20	30	Y-4T3F1U2030B	884	+63	+125
24	24	Y-4T3F1U2424B	855	+60	+120
24	30	Y-4T3F1U2430B	975	+75	+150

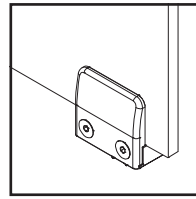
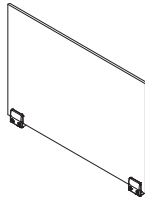

Surface Mount Clip

Specify

Notes

- Clips available in Metallic Silver only.
- Standard products for glass are always clear unless noted otherwise, other colors may be available upon special request (upcharges apply).

Lexan Oxygen Worksurface Depth Territory Under Surface Mount Clip Screens

Material	Where Used	Screen Type	Sized For	Mount Type	Handedness
Lexan 1/4"	Territory on Worksurface	Clip	Oxygen Worksurface Depth	Under Surface Mount	Left, Right or Shared

LEXAN 1/4" OXYGEN WORKSURFACE DEPTH TERRITORY UNDER SURFACE MOUNT CLIP SCREENS

H	D	Left Hand	Right Hand	Shared	List
		Model Number	Model Number	Model Number	
12	24	Y-1T3F2L1224B	Y-1T3F2R1224B	Y-1T3F2S1224B	605
16	24	Y-1T3F2L1624B	Y-1T3F2R1624B	Y-1T3F2S1624B	655
20	24	Y-1T3F2L2024B	Y-1T3F2R2024B	Y-1T3F2S2024B	704
12	30	Y-1T3F2L1230B	Y-1T3F2R1230B	Y-1T3F2S1230B	642
16	30	Y-1T3F2L1630B	Y-1T3F2R1630B	Y-1T3F2S1630B	704
20	30	Y-1T3F2L2030B	Y-1T3F2R2030B	Y-1T3F2S2030B	766

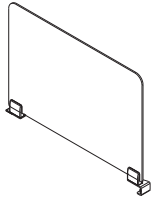

Left Hand

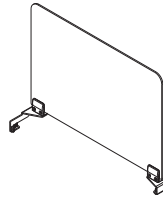

Right Hand

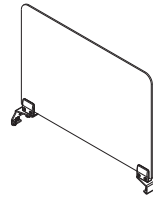

Shared

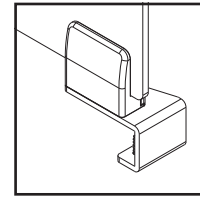

Under Surface Mount Clip

Specify

Notes

- Clips available in Metallic Silver only.
- Lexan available only in clear.

Glass Oxygen Worksurface Depth Territory Under Surface Mount Clip Screens

Material	Where Used	Screen Type	Sized For	Mount Type	Handedness
Glass 1/4"	Territory on Worksurface	Clip	Oxygen Worksurface Depth	Under Surface Mount	Left, Right or Shared

**GLASS 1/4" OXYGEN WORKSURFACE DEPTH
TERRITORY UNDER SURFACE MOUNT CLIP SCREENS**

H	D	Left Hand	Right Hand	Shared	List	Tinted Glass	Frosted Glass
		Model Number	Model Number	Model Number			
12	24	Y-3T3F2L1224B	Y-3T3F2R1224B	Y-3T3F2S1224B	535	+30	+110
12	30	Y-3T3F2L1230B	Y-3T3F2R1230B	Y-3T3F2S1230B	542	+38	+138
16	24	Y-3T3F2L1624B	Y-3T3F2R1624B	Y-3T3F2S1624B	661	+40	+147
16	30	Y-3T3F2L1630B	Y-3T3F2R1630B	Y-3T3F2S1630B	687	+50	+184
20	24	Y-3T3F2L2024B	Y-3T3F2R2024B	Y-3T3F2S2024B	606	+50	+184
20	30	Y-3T3F2L2030B	Y-3T3F2R2030B	Y-3T3F2S2030B	659	+63	+230
24	24	Y-3T3F2L2424B	Y-3T3F2R2424B	Y-3T3F2S2424B	647	+60	+220
24	30	Y-3T3F2L2430B	Y-3T3F2R2430B	Y-3T3F2S2430B	710	+75	+275

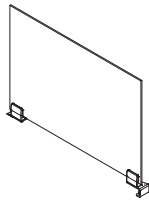

Left Hand

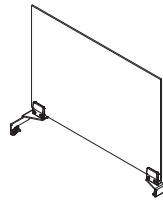

Right Hand

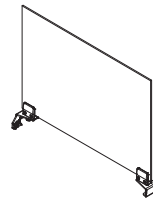

Shared

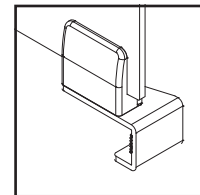

Under Surface Mount Clip

Specify

Notes

- Clips available in Metallic Silver only.
- Standard products for glass are always clear unless noted otherwise, other colors may be available upon special request (upcharges apply).

Glass Oxygen Worksurface Depth Territory Under Surface Mount Clip Screens

Material	Where Used	Screen Type	Sized For	Mount Type	Handedness
Glass 3/8"	Territory on Worksurface	Clip	Oxygen Worksurface Depth	Under Surface Mount	Left, Right or Shared

GLASS 3/8" OXYGEN WORKSURFACE DEPTH TERRITORY UNDER SURFACE MOUNT CLIP SCREENS

H	D	Left Hand	Right Hand	Shared	List	Tinted Glass	Frosted Glass
		Model Number	Model Number	Model Number			
12	24	Y-4T3F2L1224B	Y-4T3F2R1224B	Y-4T3F2S1224B	718	+30	+60
12	30	Y-4T3F2L1230B	Y-4T3F2R1230B	Y-4T3F2S1230B	722	+38	+75
16	24	Y-4T3F2L1624B	Y-4T3F2R1624B	Y-4T3F2S1624B	684	+40	+80
16	30	Y-4T3F2L1630B	Y-4T3F2R1630B	Y-4T3F2S1630B	764	+50	+100
20	24	Y-4T3F2L2024B	Y-4T3F2R2024B	Y-4T3F2S2024B	780	+50	+100
20	30	Y-4T3F2L2030B	Y-4T3F2R2030B	Y-4T3F2S2030B	884	+63	+125
24	24	Y-4T3F2L2424B	Y-4T3F2R2424B	Y-4T3F2S2424B	855	+60	+120
24	30	Y-4T3F2L2430B	Y-4T3F2R2430B	Y-4T3F2S2430B	975	+75	+150

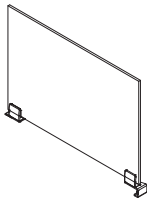

Left Hand

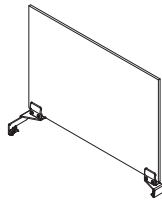

Right Hand

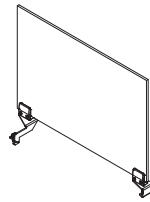

Shared

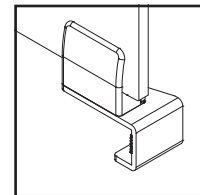

Under Surface Mount Clip

Specify

Notes

- Clips available in Metallic Silver only.
- Standard products for glass are always clear unless noted otherwise, other colors may be available upon special request (upcharges apply).

Lexan Oxygen Worksurface Depth Territory Freestanding Clip Screens

Material	Where Used	Screen Type	Sized For	Mount Type
Lexan 1/4"	Territory on Worksurface	Clip	Oxygen Worksurface Depth	Freestanding

**LXAN 1/4" OXYGEN WORKSURFACE DEPTH
TERRITORY FREESTANDING CLIP SCREENS**

H	D	Model Number	List
12	24	Y-1T3F4U1224B	735
16	24	Y-1T3F4U1624B	786
20	24	Y-1T3F4U2024B	834
12	30	Y-1T3F4U1230B	771
16	30	Y-1T3F4U1630B	834
20	30	Y-1T3F4U2030B	897

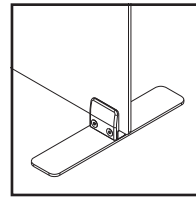
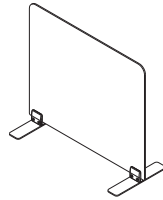

Freestanding Clip

Specify

Notes

- Clips available in Metallic Silver only.
- Lexan available only in clear.
- Non-marring feet measure 2 3/8" x 12".

PET Oxygen Worksurface Depth Territory Surface Mount Lite Screens

Material	Where Used	Screen Type	Sized For	Mount Type
PET	Territory on Worksurface	Lite	Oxygen Worksurface Depth	Surface Mount

**PET OXYGEN WORKSURFACE DEPTH
TERRITORY SURFACE MOUNT LITE SCREENS**

H	D	Model Number	List
12	24	Y-5T4F1U1224B	494
16	24	Y-5T4F1U1624B	506
20	24	Y-5T4F1U2024B	518
24	24	Y-5T4F1U2424B	533
28	24	Y-5T4F1U2824B	544
32	24	Y-5T4F1U3224B	557
12	30	Y-5T4F1U1230B	504
16	30	Y-5T4F1U1630B	518
20	30	Y-5T4F1U2030B	535
24	30	Y-5T4F1U2430B	549
28	30	Y-5T4F1U2830B	567
32	30	Y-5T4F1U3230B	583

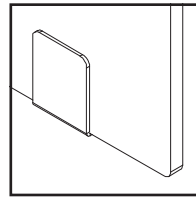
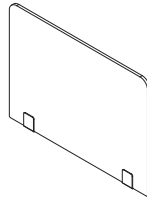

Surface Mount Lite

Specify

- Paint Selection (Grade C +10)
- Color Selection for PET - Lite Grey, Medium Grey, Tan or Vibrant Blue

Notes

- PET Territory Screens are designed to mount to AIS worksurfaces. Specify based on nominal size for the desired system. Order screens that correspond to worksurface width.
- PET screen inserts are 1/2" (12mm) thick.

PET Oxygen Worksurface Depth Territory Under Surface Mount Lite Screens

Material	Where Used	Screen Type	Sized For	Mount Type	Handedness
PET	Territory on Worksurface	Lite	Oxygen Worksurface Depth	Under Surface Mount	Left, Right or Shared

**PET OXYGEN WORKSURFACE DEPTH
TERRITORY UNDER SURFACE MOUNT LITE SCREENS**

H	D	Left Hand	Right Hand	Shared	List
		Model Number	Model Number	Model Number	
12	24	Y-5T4F2L1224B	Y-5T4F2R1224B	Y-5T4F2S1224B	494
16	24	Y-5T4F2L1624B	Y-5T4F2R1624B	Y-5T4F2S1624B	506
20	24	Y-5T4F2L2024B	Y-5T4F2R2024B	Y-5T4F2S2024B	518
24	24	Y-5T4F2L2424B	Y-5T4F2R2424B	Y-5T4F2S2424B	533
28	24	Y-5T4F2L2824B	Y-5T4F2R2824B	Y-5T4F2S2824B	544
32	24	Y-5T4F2L3224B	Y-5T4F2R3224B	Y-5T4F2S3224B	557
12	30	Y-5T4F2L1230B	Y-5T4F2R1230B	Y-5T4F2S1230B	504
16	30	Y-5T4F2L1630B	Y-5T4F2R1630B	Y-5T4F2S1630B	518
20	30	Y-5T4F2L2030B	Y-5T4F2R2030B	Y-5T4F2S2030B	535
24	30	Y-5T4F2L2430B	Y-5T4F2R2430B	Y-5T4F2S2430B	549
28	30	Y-5T4F2L2830B	Y-5T4F2R2830B	Y-5T4F2S2830B	567
32	30	Y-5T4F2L3230B	Y-5T4F2R3230B	Y-5T4F2S3230B	583

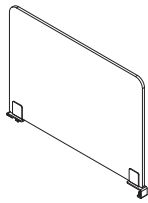

Left Hand

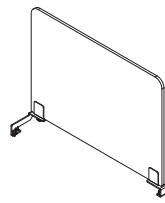

Right Hand

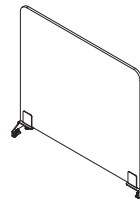

Shared

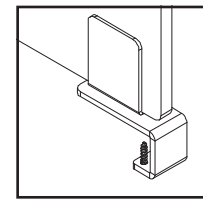

Under Surface Mount Lite

Specify

- Paint Selection (Grade C +10)
- Color Selection for PET - Lite Grey, Medium Grey, Tan or Vibrant Blue

Notes

- PET Territory Screens are designed to mount to AIS worksurfaces. Specify based on nominal size for the desired system. Order screens that correspond to worksurface width.
- PET screen inserts are 1/2" (12mm) thick.

PET Oxygen Worksurface Depth Territory Freestanding Lite Screens

Material	Where Used	Screen Type	Sized For	Mount Type
PET	Territory on Worksurface	Lite	Oxygen Worksurface Depth	Freestanding

PET OXYGEN WORKSURFACE DEPTH
TERRITORY FREESTANDING LITE SCREENS

H	D	Model Number	List
12	24	Y-5T4F4U1224B	624
16	24	Y-5T4F4U1624B	637
20	24	Y-5T4F4U2024B	648
24	24	Y-5T4F4U2424B	663
28	24	Y-5T4F4U2824B	674
32	24	Y-5T4F4U3224B	687
12	30	Y-5T4F4U1230B	634
16	30	Y-5T4F4U1630B	648
20	30	Y-5T4F4U2030B	665
24	30	Y-5T4F4U2430B	680
28	30	Y-5T4F4U2830B	697
32	30	Y-5T4F4U3230B	660

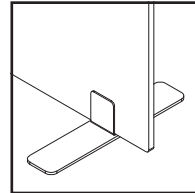
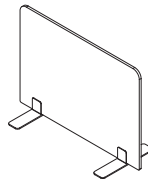

Surface Mount Lite

Specify

- Paint Selection (Grade C +10)
- Color Selection for PET - Lite Grey, Medium Grey, Tan or Vibrant Blue

Notes

- PET Territory Screens are designed to mount to AIS worksurfaces. Specify based on nominal size for the desired system. Order screens that correspond to worksurface width.
- PET screen inserts are 1/2" (12mm) thick.
- Non-marring feet measure 2 3/8" x 12".

Oxygen Worksurface Depth Territory Surface Mount Slimline Screens

Material	Where Used	Screen Type	Sized For	Mount Type
Fabric/Vinyl/Whiteboard/Laminate	Territory on Worksurface	Slimline	Oxygen Worksurface Depth	Surface Mount

**OXYGEN WORKSURFACE DEPTH
TERRITORY SURFACE MOUNT SLIMLINE SCREENS**

H	D	Model Number	List	Fabric Grade C	Fabric Grade D
12	24	Y-6T1F1U1224B	647	+7	+14
16	24	Y-6T1F1U1624B	715	+11	+22
20	24	Y-6T1F1U2024B	648	+15	+30
24	24	Y-6T1F1U2424B	693	+18	+36
28	24	Y-6T1F1U2824B	767	+21	+42
12	30	Y-6T1F1U1230B	555	+7	+14
16	30	Y-6T1F1U1630B	715	+11	+22
20	30	Y-6T1F1U2030B	787	+15	+30
24	30	Y-6T1F1U2430B	830	+18	+36
28	30	Y-6T1F1U2830B	912	+21	+42

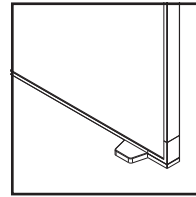
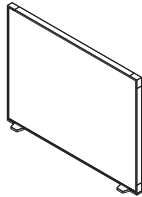

Surface Mount Slimline

Specify

- Paint Selection (Grade C +10)
- Fabric, Vinyl, Whiteboard or Laminate Selection

Notes

- Slimline screens may be fabric, vinyl, whiteboard or laminate on either side. Upcharges for Grade C and D are listed per side. Whiteboards are standard list and have no upcharge.
- Offered in all AIS paint finishes.

Oxygen Worksurface Depth Territory Under Surface Mount Slimline Screens

Material	Where Used	Screen Type	Sized For	Mount Type	Handedness
Fabric/Vinyl/Whiteboard/Laminate	Territory on Worksurface	Slimline	Oxygen Worksurface Depth	Under Surface Mount	Left, Right or Shared

OXYGEN WORKSURFACE DEPTH TERRITORY UNDER SURFACE MOUNT SLIMLINE SCREENS

H	D	Left Hand	Right Hand	Shared	List	Fabric Grade C	Fabric Grade D
		Model Number	Model Number	Model Number			
12	24	O-TSHL1224	O-TSHR1224	O-TSHC1224	569	+7	+14
16	24	O-TSHL1624	O-TSHR1624	O-TSHC1624	616	+11	+22
20	24	O-TSHL2024	O-TSHR2024	O-TSHC2024	664	+15	+30
24	24	O-TSHL2424	O-TSHR2424	O-TSHC2424	710	+18	+36
28	24	O-TSHL2824	O-TSHR2824	O-TSHC2824	758	+21	+42
12	30	O-TSHL1230	O-TSHR1230	O-TSHC1230	663	+7	+14
16	30	O-TSHL1630	O-TSHR1630	O-TSHC1630	731	+11	+22
20	30	O-TSHL2030	O-TSHR2030	O-TSHC2030	801	+15	+30
24	30	O-TSHL2430	O-TSHR2430	O-TSHC2430	964	+18	+36
28	30	O-TSHL2830	O-TSHR2830	O-TSHC2830	941	+21	+42

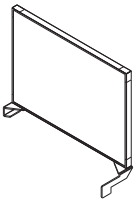

Left

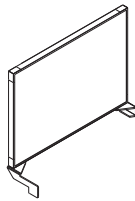

Right

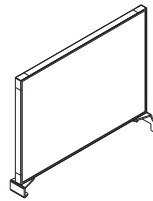

Shared

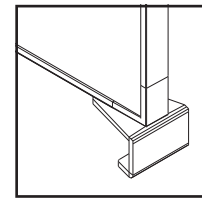

Under Surface Mount Slimline

Specify

- Paint Selection (Grade C +10)
- Fabric, Vinyl, Whiteboard or Laminate Selection

Notes

- Slimline screens may be fabric, vinyl, whiteboard or laminate on either side. Upcharges for Grade C and D are listed per side. Whiteboards are standard list and have no upcharge.
- Offered in all AIS paint finishes.

Oxygen Worksurface Depth Side Split Slimline Screens

Material	Where Used	Screen Type	Sized For	Mount Type
Fabric/Vinyl/Whiteboard/Laminate	Side Split on Worksurface	Slimline	Oxygen Worksurface Depth	Side Mount

**OXYGEN WORKSURFACE DEPTH
SIDE SPLIT SLIMLINE SCREEN**

H	W	Horizon Planning	Model Number	List	Fabric Grade C	Fabric Grade D
26	24	42"H Horizon	O-SMH2624	1,052	+25	+50
26	30	42"H Horizon	O-SMH2630	1,098	+25	+50
26	36	42"H Horizon	O-SMH2636	1,142	+25	+50
26	42	42"H Horizon	O-SMH2642	1,187	+25	+50
26	48	42"H Horizon	O-SMH2648	1,237	+25	+50
26	54	42"H Horizon	O-SMH2654	1,282	+25	+50
26	60	42"H Horizon	O-SMH2660	1,327	+25	+50
34	24	46"H Horizon	O-SMH3424	1,183	+34	+68
34	30	46"H Horizon	O-SMH3430	1,238	+34	+68
34	36	46"H Horizon	O-SMH3436	1,289	+34	+68
34	42	46"H Horizon	O-SMH3442	1,342	+34	+68
34	48	46"H Horizon	O-SMH3448	1,395	+34	+68
34	54	46"H Horizon	O-SMH3454	1,448	+34	+68
34	60	46"H Horizon	O-SMH3460	1,501	+34	+68

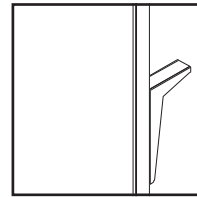
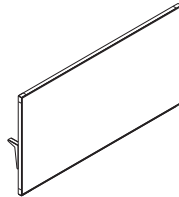

Side Mount

Specify

- Paint Selection (Grade C +10)
- Fabric or White Board

Notes

- Designed to side mount to the return worksurfaces. Side Split screens do not attach to the spine beam as a modesty.
- Side Split screens may be fabric or white board (either side).
- Slimline screens may be fabric, vinyl, whiteboard or laminate on either side. Upcharges for Grade C and D are listed per side. Whiteboards are standard list and have no upcharge.
- Offered in all AIS paint finishes.

Screens Sized for Day-to-Day, Calibrate & Benching HAT Widths

Lexan Day-to-Day, Calibrate & Benching HAT Width Front/Rear Surface Mount Channel Screens

Material	Where Used	Screen Type	Sized For	Mount Type
Lexan 1/4"	Front/Rear on Worksurface	Channel	Day-to-Day, Calibrate & Benching HAT Width	Surface Mount

LEXAN 1/4" DAY-TO-DAY, CALIBRATE & BENCHING HAT WIDTH FRONT/REAR CHANNEL SURFACE MOUNT SCREENS

H	W	Model Number	List
12	24	Y-1R2G1U1224B	605
12	30	Y-1R2G1U1230B	642
12	36	Y-1R2G1U1236B	679
12	42	Y-1R2G1U1242B	717
12	48	Y-1R2G1U1248B	755
12	54	Y-1R2G1U1254B	791
12	60	Y-1R2G1U1260B	829
12	66	Y-1R2G1U1266B	867
12	72	Y-1R2G1U1272B	903
12	78	Y-1R2G1U1278B	939
12	84	Y-1R2G1U1284B	976
16	24	Y-1R2G1U1624B	655
16	30	Y-1R2G1U1630B	704
16	36	Y-1R2G1U1636B	755
16	42	Y-1R2G1U1642B	804
16	48	Y-1R2G1U1648B	855
16	54	Y-1R2G1U1654B	903
16	60	Y-1R2G1U1660B	954
16	66	Y-1R2G1U1666B	1,002
16	72	Y-1R2G1U1672B	1,052
16	78	Y-1R2G1U1678B	1,102
16	84	Y-1R2G1U1684B	1,154

LEXAN 1/4" DAY-TO-DAY, CALIBRATE & BENCHING HAT WIDTH FRONT/REAR CHANNEL SURFACE MOUNT SCREENS

H	W	Model Number	List
20	24	Y-1R2G1U2024B	704
20	30	Y-1R2G1U2030B	766
20	36	Y-1R2G1U2036B	829
20	42	Y-1R2G1U2042B	890
20	48	Y-1R2G1U2048B	954
20	54	Y-1R2G1U2054B	1,017
20	60	Y-1R2G1U2060B	1,080
20	66	Y-1R2G1U2066B	1,141
20	72	Y-1R2G1U2072B	1,204
20	78	Y-1R2G1U2078B	1,267
20	84	Y-1R2G1U2084B	1,329

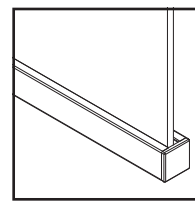
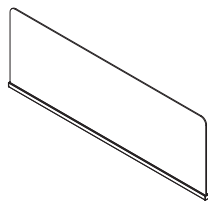

Surface Mount Channel

Specify

• Paint Selection (Grade C +10)

Notes

- Offered in all AIS paint finishes.
- Lexan available only in clear.

Glass Day-to-Day, Calibrate & Benching HAT Width Front/Rear Surface Mount Channel Screens

Material	Where Used	Screen Type	Sized For	Mount Type
Glass 1/4"	Front/Rear on Worksurface	Channel	Day-to-Day, Calibrate & Benching HAT Width	Surface Mount

GLASS 1/4" DAY-TO-DAY, CALIBRATE & BENCHING HAT WIDTH FRONT/REAR CHANNEL SURFACE MOUNT SCREENS

H	W	Model Number	List	Tinted Glass	Frosted Glass
12	24	Y-3R2G1U1224B	535	+30	+110
12	30	Y-3R2G1U1230B	542	+38	+138
12	36	Y-3R2G1U1236B	549	+45	+165
12	42	Y-3R2G1U1242B	578	+53	+193
12	48	Y-3R2G1U1248B	607	+60	+220
12	54	Y-3R2G1U1254B	727	+68	+248
12	60	Y-3R2G1U1260B	666	+75	+275
12	66	Y-3R2G1U1266B	695	+83	+303
12	72	Y-3R2G1U1272B	724	+90	+330
12	78	Y-3R2G1U1278B	753	+98	+358
12	84	Y-3R2G1U1284B	779	+105	+385
16	24	Y-3R2G1U1624B	661	+40	+147
16	30	Y-3R2G1U1630B	687	+50	+184
16	36	Y-3R2G1U1636B	727	+60	+220
16	42	Y-3R2G1U1642B	756	+70	+257
16	48	Y-3R2G1U1648B	789	+80	+294
16	54	Y-3R2G1U1654B	840	+90	+330
16	60	Y-3R2G1U1660B	887	+100	+367
16	66	Y-3R2G1U1666B	899	+110	+404
16	72	Y-3R2G1U1672B	920	+120	+440
16	78	Y-3R2G1U1678B	937	+130	+477
16	84	Y-3R2G1U1684B	954	+140	+514

GLASS 1/4" DAY-TO-DAY, CALIBRATE & BENCHING HAT WIDTH FRONT/REAR CHANNEL SURFACE MOUNT SCREENS

H	W	Model Number	List	Tinted Glass	Frosted Glass
20	24	Y-3R2G1U2024B	606	+50	+184
20	30	Y-3R2G1U2030B	659	+63	+230
20	36	Y-3R2G1U2036B	695	+75	+275
20	42	Y-3R2G1U2042B	765	+88	+321
20	48	Y-3R2G1U2048B	816	+100	+367
20	54	Y-3R2G1U2054B	869	+113	+413
20	60	Y-3R2G1U2060B	922	+125	+459
20	66	Y-3R2G1U2066B	975	+138	+505
20	72	Y-3R2G1U2072B	1,028	+150	+550
20	78	Y-3R2G1U2078B	1,082	+163	+596
20	84	Y-3R2G1U2084B	1,133	+175	+642
24	24	Y-3R2G1U2424B	647	+60	+220
24	30	Y-3R2G1U2430B	710	+75	+275
24	36	Y-3R2G1U2436B	773	+90	+330
24	42	Y-3R2G1U2442B	834	+105	+385
24	48	Y-3R2G1U2448B	897	+120	+440
24	54	Y-3R2G1U2454B	958	+135	+495
24	60	Y-3R2G1U2460B	1,021	+150	+550
24	66	Y-3R2G1U2466B	1,085	+165	+605
24	72	Y-3R2G1U2472B	1,145	+180	+660
24	78	Y-3R2G1U2478B	1,206	+195	+715
24	84	Y-3R2G1U2484B	1,267	+210	+770

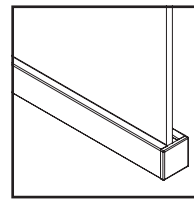
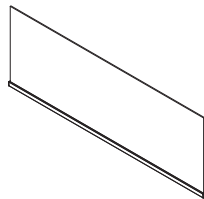

Surface Mount Channel

Specify

• Paint Selection (Grade C +10)

Notes

• Offered in all AIS paint finishes.

• Standard products for glass are always clear unless noted otherwise, other colors may be available upon special request (upcharges apply).

SCREENS

CHANNEL SCREENS FOR DAY-TO-DAY, CALIBRATE & BENCHING HAT WIDTHS

Glass Day-to-Day, Calibrate & Benching HAT Width Front/Rear Surface Mount Channel Screens

Material	Where Used	Screen Type	Sized For	Mount Type
Glass 3/8"	Front/Rear on Worksurface	Channel	Day-to-Day, Calibrate & Benching HAT Width	Surface Mount

GLASS 3/8" DAY-TO-DAY, CALIBRATE & BENCHING HAT WIDTH FRONT/REAR CHANNEL SURFACE MOUNT SCREENS

H	W	Model Number	List	Tinted Glass	Frosted Glass
12	24	Y-4R2G1U1224B	718	+30	+60
12	30	Y-4R2G1U1230B	722	+38	+75
12	36	Y-4R2G1U1236B	786	+45	+90
12	42	Y-4R2G1U1242B	848	+53	+105
12	48	Y-4R2G1U1248B	914	+60	+120
12	54	Y-4R2G1U1254B	979	+68	+135
12	60	Y-4R2G1U1260B	1,045	+75	+150
12	66	Y-4R2G1U1266B	1,109	+83	+165
12	72	Y-4R2G1U1272B	1,173	+90	+180
12	78	Y-4R2G1U1278B	1,239	+98	+195
12	84	Y-4R2G1U1284B	1,304	+105	+210
16	24	Y-4R2G1U1624B	684	+40	+80
16	30	Y-4R2G1U1630B	764	+50	+100
16	36	Y-4R2G1U1636B	801	+60	+120
16	42	Y-4R2G1U1642B	891	+70	+140
16	48	Y-4R2G1U1648B	988	+80	+160
16	54	Y-4R2G1U1654B	1,056	+90	+180
16	60	Y-4R2G1U1660B	1,087	+100	+200
16	66	Y-4R2G1U1666B	1,184	+110	+220
16	72	Y-4R2G1U1672B	1,258	+120	+240
16	78	Y-4R2G1U1678B	1,280	+130	+260
16	84	Y-4R2G1U1684B	1,344	+140	+280

GLASS 3/8" DAY-TO-DAY, CALIBRATE & BENCHING HAT WIDTH FRONT/REAR CHANNEL SURFACE MOUNT SCREENS

H	W	Model Number	List	Tinted Glass	Frosted Glass
20	24	Y-4R2G1U2024B	780	+50	+100
20	30	Y-4R2G1U2030B	884	+63	+125
20	36	Y-4R2G1U2036B	984	+75	+150
20	42	Y-4R2G1U2042B	1,086	+88	+175
20	48	Y-4R2G1U2048B	1,184	+100	+200
20	54	Y-4R2G1U2054B	1,287	+113	+225
20	60	Y-4R2G1U2060B	1,387	+125	+250
20	66	Y-4R2G1U2066B	1,489	+138	+275
20	72	Y-4R2G1U2072B	1,587	+150	+300
20	78	Y-4R2G1U2078B	1,687	+163	+325
20	84	Y-4R2G1U2084B	1,788	+175	+350
24	24	Y-4R2G1U2424B	855	+60	+120
24	30	Y-4R2G1U2430B	975	+75	+150
24	36	Y-4R2G1U2436B	1,093	+90	+180
24	42	Y-4R2G1U2442B	1,212	+105	+210
24	48	Y-4R2G1U2448B	1,331	+120	+240
24	54	Y-4R2G1U2454B	1,450	+135	+270
24	60	Y-4R2G1U2460B	1,571	+150	+300
24	66	Y-4R2G1U2466B	1,690	+165	+330
24	72	Y-4R2G1U2472B	1,807	+180	+360
24	78	Y-4R2G1U2478B	1,925	+195	+390
24	84	Y-4R2G1U2484B	2,044	+210	+420

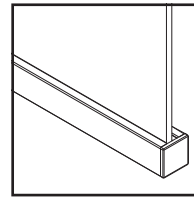
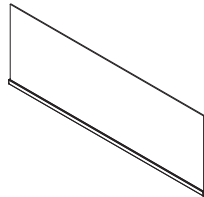

Surface Mount Channel

Specify

• Paint Selection (Grade C +10)

Notes

• Offered in all AIS paint finishes.

• Standard products for glass are always clear unless noted otherwise, other colors may be available upon special request (upcharges apply).

PET Day-to-Day, Calibrate & Benching HAT Width Front/Rear Surface Mount Channel Screens

Material	Where Used	Screen Type	Sized For	Mount Type
PET	Front/Rear on Worksurface	Channel	Day-to-Day, Calibrate & Benching HAT Width	Surface Mount

PET DAY-TO-DAY, CALIBRATE & BENCHING HAT WIDTH FRONT/REAR CHANNEL SURFACE MOUNT SCREENS

H	W	Model Number	List
12	24	Y-5R2G1U1224B	464
12	30	Y-5R2G1U1230B	480
12	36	Y-5R2G1U1236B	497
12	42	Y-5R2G1U1242B	512
12	48	Y-5R2G1U1248B	531
12	54	Y-5R2G1U1254B	546
12	60	Y-5R2G1U1260B	563
12	66	Y-5R2G1U1266B	578
12	72	Y-5R2G1U1272B	594
12	78	Y-5R2G1U1278B	612
12	84	Y-5R2G1U1284B	627
16	24	Y-5R2G1U1624B	485
16	30	Y-5R2G1U1630B	507
16	36	Y-5R2G1U1636B	531
16	42	Y-5R2G1U1642B	551
16	48	Y-5R2G1U1648B	574
16	54	Y-5R2G1U1654B	594
16	60	Y-5R2G1U1660B	616
16	66	Y-5R2G1U1666B	639
16	72	Y-5R2G1U1672B	661
16	78	Y-5R2G1U1678B	683
16	84	Y-5R2G1U1684B	705

PET DAY-TO-DAY, CALIBRATE & BENCHING HAT WIDTH FRONT/REAR CHANNEL SURFACE MOUNT SCREENS

H	W	Model Number	List
20	24	Y-5R2G1U2024B	507
20	30	Y-5R2G1U2030B	535
20	36	Y-5R2G1U2036B	563
20	42	Y-5R2G1U2042B	589
20	48	Y-5R2G1U2048B	617
20	54	Y-5R2G1U2054B	645
20	60	Y-5R2G1U2060B	673
20	66	Y-5R2G1U2066B	699
20	72	Y-5R2G1U2072B	727
20	78	Y-5R2G1U2078B	755
20	84	Y-5R2G1U2084B	780
24	24	Y-5R2G1U2424B	531
24	30	Y-5R2G1U2430B	563
24	36	Y-5R2G1U2436B	594
24	42	Y-5R2G1U2442B	628
24	48	Y-5R2G1U2448B	661
24	54	Y-5R2G1U2454B	694
24	60	Y-5R2G1U2460B	727
24	66	Y-5R2G1U2466B	760
24	72	Y-5R2G1U2472B	793
24	78	Y-5R2G1U2478B	826
24	84	Y-5R2G1U2484B	859

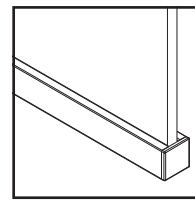
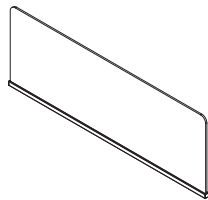

Surface Mount Channel

Specify

- Paint Selection (Grade C +10)
- Color Selection for PET - Lite Grey, Medium Grey, Tan or Vibrant Blue

Notes

- Offered in all AIS paint finishes.

PET Day-to-Day, Calibrate & Benching HAT Width Front/Rear Surface Mount Channel Screens

Material	Where Used	Screen Type	Sized For	Mount Type
PET	Front/Rear on Worksurface	Channel	Day-to-Day, Calibrate & Benching HAT Width	Surface Mount

PET DAY-TO-DAY, CALIBRATE & BENCHING HAT WIDTH FRONT/REAR CHANNEL SURFACE MOUNT SCREENS

H	W	Model Number	List
28	24	Y-5R2G1U2824B	551
28	30	Y-5R2G1U2830B	589
28	36	Y-5R2G1U2836B	627
28	42	Y-5R2G1U2842B	666
28	48	Y-5R2G1U2848B	705
28	54	Y-5R2G1U2854B	742
28	60	Y-5R2G1U2860B	779
28	66	Y-5R2G1U2866B	820
28	72	Y-5R2G1U2872B	858
28	78	Y-5R2G1U2878B	897
28	84	Y-5R2G1U2884B	935
32	24	Y-5R2G1U3224B	574
32	30	Y-5R2G1U3230B	616
32	36	Y-5R2G1U3236B	659
32	42	Y-5R2G1U3242B	705
32	48	Y-5R2G1U3248B	748
32	54	Y-5R2G1U3254B	791
32	60	Y-5R2G1U3260B	835
32	66	Y-5R2G1U3266B	877
32	72	Y-5R2G1U3272B	922
32	78	Y-5R2G1U3278B	966
32	84	Y-5R2G1U3284B	1,010

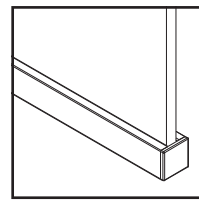
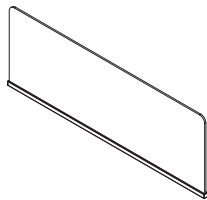

Surface Mount Channel

Specify

Notes

- Paint Selection (Grade C +10)
- Color Selection for PET - Lite Grey, Medium Grey, Tan or Vibrant Blue

- Offered in all AIS paint finishes.

Lexan Day-to-Day, Calibrate & Benching HAT Width Front/Rear Under Surface Mount Channel Screens

Material	Where Used	Screen Type	Sized For	Mount Type
Lexan 1/4"	Front/Rear on Worksurface	Channel	Day-to-Day, Calibrate & Benching HAT Width	Under Surface Mount

LEXAN 1/4" DAY-TO-DAY, CALIBRATE & BENCHING HAT WIDTH FRONT/REAR UNDER SURFACE MOUNT CHANNEL SCREENS

H	W	Model Number	List
12	24	Y-1R2G2U1224B	735
12	30	Y-1R2G2U1230B	771
12	36	Y-1R2G2U1236B	808
12	42	Y-1R2G2U1242B	846
12	48	Y-1R2G2U1248B	885
12	54	Y-1R2G2U1254B	921
12	60	Y-1R2G2U1260B	958
12	66	Y-1R2G2U1266B	996
12	72	Y-1R2G2U1272B	1,032
12	78	Y-1R2G2U1278B	1,069
12	84	Y-1R2G2U1284B	1,105
16	24	Y-1R2G2U1624B	786
16	30	Y-1R2G2U1630B	834
16	36	Y-1R2G2U1636B	885
16	42	Y-1R2G2U1642B	935
16	48	Y-1R2G2U1648B	985
16	54	Y-1R2G2U1654B	1,032
16	60	Y-1R2G2U1660B	1,085
16	66	Y-1R2G2U1666B	1,132
16	72	Y-1R2G2U1672B	1,182
16	78	Y-1R2G2U1678B	1,233
16	84	Y-1R2G2U1684B	1,284

LEXAN 1/4" DAY-TO-DAY, CALIBRATE & BENCHING HAT WIDTH FRONT/REAR UNDER SURFACE MOUNT CHANNEL SCREENS

H	W	Model Number	List
20	24	Y-1R2G2U2024B	834
20	30	Y-1R2G2U2030B	897
20	36	Y-1R2G2U2036B	958
20	42	Y-1R2G2U2042B	1,021
20	48	Y-1R2G2U2048B	1,085
20	54	Y-1R2G2U2054B	1,146
20	60	Y-1R2G2U2060B	1,210
20	66	Y-1R2G2U2066B	1,272
20	72	Y-1R2G2U2072B	1,333
20	78	Y-1R2G2U2078B	1,396
20	84	Y-1R2G2U2084B	1,460

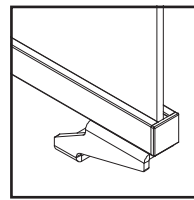
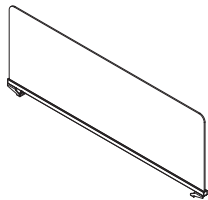

Under Surface Mount Channel

Specify

• Paint Selection (Grade C +10)

Notes

- Offered in all AIS paint finishes.
- Lexan available only in clear.

SCREENS

CHANNEL SCREENS FOR DAY-TO-DAY, CALIBRATE & BENCHING HAT WIDTHS

Glass Day-to-Day, Calibrate & Benching HAT Width Front/Rear Under Surface Mount Channel Screens

Material	Where Used	Screen Type	Sized For	Mount Type
Glass 1/4"	Front/Rear on Worksurface	Channel	Day-to-Day, Calibrate & Benching HAT Width	Under Surface Mount

GLASS 1/4" DAY-TO-DAY, CALIBRATE & BENCHING HAT WIDTH FRONT/REAR UNDER SURFACE MOUNT CHANNEL SCREENS

H	W	Model Number	List	Tinted Glass	Frosted Glass
12	24	Y-3R2G2U1224B	665	+30	+110
12	30	Y-3R2G2U1230B	672	+38	+138
12	36	Y-3R2G2U1236B	680	+45	+165
12	42	Y-3R2G2U1242B	709	+53	+193
12	48	Y-3R2G2U1248B	737	+60	+220
12	54	Y-3R2G2U1254B	858	+68	+248
12	60	Y-3R2G2U1260B	796	+75	+275
12	66	Y-3R2G2U1266B	826	+83	+303
12	72	Y-3R2G2U1272B	854	+90	+330
12	78	Y-3R2G2U1278B	881	+98	+358
12	84	Y-3R2G2U1284B	910	+105	+385
16	24	Y-3R2G2U1624B	791	+40	+147
16	30	Y-3R2G2U1630B	816	+50	+184
16	36	Y-3R2G2U1636B	858	+60	+220
16	42	Y-3R2G2U1642B	886	+70	+257
16	48	Y-3R2G2U1648B	918	+80	+294
16	54	Y-3R2G2U1654B	970	+90	+330
16	60	Y-3R2G2U1660B	1,018	+100	+367
16	66	Y-3R2G2U1666B	1,029	+110	+404
16	72	Y-3R2G2U1672B	1,050	+120	+440
16	78	Y-3R2G2U1678B	1,066	+130	+477
16	84	Y-3R2G2U1684B	1,085	+140	+514

GLASS 1/4" DAY-TO-DAY, CALIBRATE & BENCHING HAT WIDTH FRONT/REAR UNDER SURFACE MOUNT CHANNEL SCREENS

H	W	Model Number	List	Tinted Glass	Frosted Glass
20	24	Y-3R2G2U2024B	736	+50	+184
20	30	Y-3R2G2U2030B	790	+63	+230
20	36	Y-3R2G2U2036B	826	+75	+275
20	42	Y-3R2G2U2042B	896	+88	+321
20	48	Y-3R2G2U2048B	947	+100	+367
20	54	Y-3R2G2U2054B	998	+113	+413
20	60	Y-3R2G2U2060B	1,052	+125	+459
20	66	Y-3R2G2U2066B	1,103	+138	+505
20	72	Y-3R2G2U2072B	1,158	+150	+550
20	78	Y-3R2G2U2078B	1,211	+163	+596
20	84	Y-3R2G2U2084B	1,263	+175	+642
24	24	Y-3R2G2U2424B	777	+60	+220
24	30	Y-3R2G2U2430B	840	+75	+275
24	36	Y-3R2G2U2436B	903	+90	+330
24	42	Y-3R2G2U2442B	964	+105	+385
24	48	Y-3R2G2U2448B	1,026	+120	+440
24	54	Y-3R2G2U2454B	1,089	+135	+495
24	60	Y-3R2G2U2460B	1,151	+150	+550
24	66	Y-3R2G2U2466B	1,213	+165	+605
24	72	Y-3R2G2U2472B	1,275	+180	+660
24	78	Y-3R2G2U2478B	1,334	+195	+715
24	84	Y-3R2G2U2484B	1,396	+210	+770

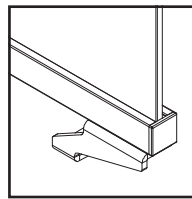
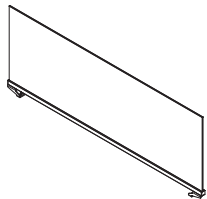

Under Surface Mount Channel

Specify

- Paint Selection (Grade C +10)

Notes

- Offered in all AIS paint finishes.
- Standard products for glass are always clear unless noted otherwise, other colors may be available upon special request (upcharges apply).

Glass Day-to-Day, Calibrate & Benching HAT Width Front/Rear Under Surface Mount Channel Screens

Material	Where Used	Screen Type	Sized For	Mount Type
Glass 3/8"	Front/Rear on Worksurface	Channel	Day-to-Day, Calibrate & Benching HAT Width	Under Surface Mount

GLASS 3/8" DAY-TO-DAY, CALIBRATE & BENCHING HAT WIDTH FRONT/REAR UNDER SURFACE MOUNT CHANNEL SCREENS

H	W	Model Number	List	Tinted Glass	Frosted Glass
12	24	Y-4R2G2U1224B	847	+30	+60
12	30	Y-4R2G2U1230B	850	+38	+75
12	36	Y-4R2G2U1236B	914	+45	+90
12	42	Y-4R2G2U1242B	979	+53	+105
12	48	Y-4R2G2U1248B	1,045	+60	+120
12	54	Y-4R2G2U1254B	1,109	+68	+135
12	60	Y-4R2G2U1260B	1,173	+75	+150
12	66	Y-4R2G2U1266B	1,239	+83	+165
12	72	Y-4R2G2U1272B	1,304	+90	+180
12	78	Y-4R2G2U1278B	1,369	+98	+195
12	84	Y-4R2G2U1284B	1,434	+105	+210
16	24	Y-4R2G2U1624B	814	+40	+80
16	30	Y-4R2G2U1630B	895	+50	+100
16	36	Y-4R2G2U1636B	931	+60	+120
16	42	Y-4R2G2U1642B	1,022	+70	+140
16	48	Y-4R2G2U1648B	1,118	+80	+160
16	54	Y-4R2G2U1654B	1,184	+90	+180
16	60	Y-4R2G2U1660B	1,217	+100	+200
16	66	Y-4R2G2U1666B	1,315	+110	+220
16	72	Y-4R2G2U1672B	1,388	+120	+240
16	78	Y-4R2G2U1678B	1,410	+130	+260
16	84	Y-4R2G2U1684B	1,474	+140	+280

GLASS 3/8" DAY-TO-DAY, CALIBRATE & BENCHING HAT WIDTH FRONT/REAR UNDER SURFACE MOUNT CHANNEL SCREENS

H	W	Model Number	List	Tinted Glass	Frosted Glass
20	24	Y-4R2G2U2024B	911	+50	+100
20	30	Y-4R2G2U2030B	1,015	+63	+125
20	36	Y-4R2G2U2036B	1,113	+75	+150
20	42	Y-4R2G2U2042B	1,214	+88	+175
20	48	Y-4R2G2U2048B	1,315	+100	+200
20	54	Y-4R2G2U2054B	1,417	+113	+225
20	60	Y-4R2G2U2060B	1,516	+125	+250
20	66	Y-4R2G2U2066B	1,617	+138	+275
20	72	Y-4R2G2U2072B	1,718	+150	+300
20	78	Y-4R2G2U2078B	1,817	+163	+325
20	84	Y-4R2G2U2084B	1,917	+175	+350
24	24	Y-4R2G2U2424B	985	+60	+120
24	30	Y-4R2G2U2430B	1,103	+75	+150
24	36	Y-4R2G2U2436B	1,223	+90	+180
24	42	Y-4R2G2U2442B	1,343	+105	+210
24	48	Y-4R2G2U2448B	1,462	+120	+240
24	54	Y-4R2G2U2454B	1,581	+135	+270
24	60	Y-4R2G2U2460B	1,700	+150	+300
24	66	Y-4R2G2U2466B	1,818	+165	+330
24	72	Y-4R2G2U2472B	1,938	+180	+360
24	78	Y-4R2G2U2478B	2,056	+195	+390
24	84	Y-4R2G2U2484B	2,175	+210	+420

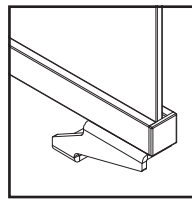
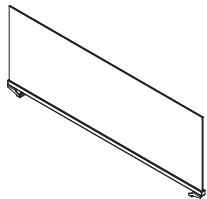

Under Surface Mount Channel

Specify

• Paint Selection (Grade C +10)

Notes

• Offered in all AIS paint finishes.

• Standard products for glass are always clear unless noted otherwise, other colors may be available upon special request (upcharges apply).

SCREENS

CHANNEL SCREENS FOR DAY-TO-DAY, CALIBRATE & BENCHING HAT WIDTHS

PET Day-to-Day, Calibrate & Benching HAT Width Front/Rear Under Surface Mount Channel Screens

Material	Where Used	Screen Type	Sized For	Mount Type
PET	Front/Rear on Worksurface	Channel	Day-to-Day, Calibrate & Benching HAT Width	Under Surface Mount

PET DAY-TO-DAY, CALIBRATE & BENCHING HAT WIDTH FRONT/REAR UNDER SURFACE MOUNT CHANNEL SCREENS

H	W	Model Number	List
12	24	Y-5R2G2U1224B	593
12	30	Y-5R2G2U1230B	610
12	36	Y-5R2G2U1236B	627
12	42	Y-5R2G2U1242B	643
12	48	Y-5R2G2U1248B	659
12	54	Y-5R2G2U1254B	677
12	60	Y-5R2G2U1260B	693
12	66	Y-5R2G2U1266B	709
12	72	Y-5R2G2U1272B	725
12	78	Y-5R2G2U1278B	740
12	84	Y-5R2G2U1284B	758
16	24	Y-5R2G2U1624B	615
16	30	Y-5R2G2U1630B	638
16	36	Y-5R2G2U1636B	659
16	42	Y-5R2G2U1642B	682
16	48	Y-5R2G2U1648B	704
16	54	Y-5R2G2U1654B	725
16	60	Y-5R2G2U1660B	747
16	66	Y-5R2G2U1666B	768
16	72	Y-5R2G2U1672B	791
16	78	Y-5R2G2U1678B	813
16	84	Y-5R2G2U1684B	835

PET DAY-TO-DAY, CALIBRATE & BENCHING HAT WIDTH FRONT/REAR UNDER SURFACE MOUNT CHANNEL SCREENS

H	W	Model Number	List
20	24	Y-5R2G2U2024B	638
20	30	Y-5R2G2U2030B	665
20	36	Y-5R2G2U2036B	693
20	42	Y-5R2G2U2042B	720
20	48	Y-5R2G2U2048B	748
20	54	Y-5R2G2U2054B	775
20	60	Y-5R2G2U2060B	803
20	66	Y-5R2G2U2066B	830
20	72	Y-5R2G2U2072B	858
20	78	Y-5R2G2U2078B	885
20	84	Y-5R2G2U2084B	911
24	24	Y-5R2G2U2424B	659
24	30	Y-5R2G2U2430B	693
24	36	Y-5R2G2U2436B	725
24	42	Y-5R2G2U2442B	759
24	48	Y-5R2G2U2448B	791
24	54	Y-5R2G2U2454B	825
24	60	Y-5R2G2U2460B	858
24	66	Y-5R2G2U2466B	889
24	72	Y-5R2G2U2472B	922
24	78	Y-5R2G2U2478B	955
24	84	Y-5R2G2U2484B	989

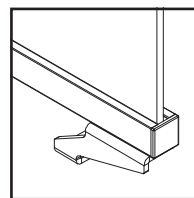
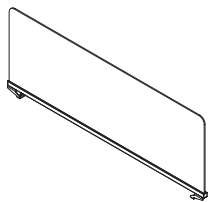

Under Surface Mount Channel

Specify

- Paint Selection (Grade C +10)
- Color Selection for PET - Lite Grey, Medium Grey, Tan or Vibrant Blue

Notes

- Offered in all AIS paint finishes.

PET Day-to-Day, Calibrate & Benching HAT Width Front/Rear Under Surface Mount Channel Screens

Material	Where Used	Screen Type	Sized For	Mount Type
PET	Front/Rear on Worksurface	Channel	Day-to-Day, Calibrate & Benching HAT Width	Under Surface Mount

PET DAY-TO-DAY, CALIBRATE & BENCHING HAT WIDTH FRONT/REAR UNDER SURFACE MOUNT CHANNEL SCREENS

H	W	Model Number	List
28	24	Y-5R2G2U2824B	682
28	30	Y-5R2G2U2830B	720
28	36	Y-5R2G2U2836B	758
28	42	Y-5R2G2U2842B	796
28	48	Y-5R2G2U2848B	835
28	54	Y-5R2G2U2854B	873
28	60	Y-5R2G2U2860B	910
28	66	Y-5R2G2U2866B	950
28	72	Y-5R2G2U2872B	988
28	78	Y-5R2G2U2878B	1,026
28	84	Y-5R2G2U2884B	1,063
32	24	Y-5R2G2U3224B	704
32	30	Y-5R2G2U3230B	747
32	36	Y-5R2G2U3236B	790
32	42	Y-5R2G2U3242B	835
32	48	Y-5R2G2U3248B	877
32	54	Y-5R2G2U3254B	921
32	60	Y-5R2G2U3260B	965
32	66	Y-5R2G2U3266B	1,008
32	72	Y-5R2G2U3272B	1,052
32	78	Y-5R2G2U3278B	1,097
32	84	Y-5R2G2U3284B	1,140

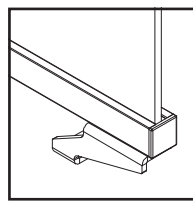
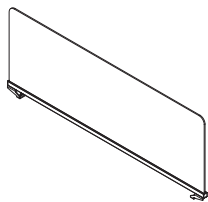

Under Surface Mount Channel

Specify

Notes

- Paint Selection (Grade C +10)
- Color Selection for PET - Lite Grey, Medium Grey, Tan or Vibrant Blue

- Offered in all AIS paint finishes.

SCREENS

CLIP SCREENS FOR DAY-TO-DAY, CALIBRATE & BENCHING HAT WIDTHS

Lexan Day-to-Day, Calibrate & Benching HAT Width Front/Rear Surface Mount Clip Screens

Material	Where Used	Screen Type	Sized For	Mount Type
Lexan 1/4"	Front/Rear on Worksurface	Clip	Day-to-Day, Calibrate & Benching HAT Width	Surface Mount

LEXAN 1/4" DAY-TO-DAY, CALIBRATE & BENCHING HAT WIDTH FRONT/REAR SURFACE MOUNT CLIP SCREENS WITHOUT CUT-OUTS

H	W	Model Number	List
12	24	Y-1R3G1U1224B	605
12	30	Y-1R3G1U1230B	642
12	36	Y-1R3G1U1236B	679
12	42	Y-1R3G1U1242B	717
12	48	Y-1R3G1U1248B	755
12	54	Y-1R3G1U1254B	791
12	60	Y-1R3G1U1260B	829
12	66	Y-1R3G1U1266B	867
12	72	Y-1R3G1U1272B	903
12	78	Y-1R3G1U1278B	939
12	84	Y-1R3G1U1284B	976
16	24	Y-1R3G1U1624B	655
16	30	Y-1R3G1U1630B	704
16	36	Y-1R3G1U1636B	755
16	42	Y-1R3G1U1642B	804
16	48	Y-1R3G1U1648B	855
16	54	Y-1R3G1U1654B	903
16	60	Y-1R3G1U1660B	954
16	66	Y-1R3G1U1666B	1,002
16	72	Y-1R3G1U1672B	1,052
16	78	Y-1R3G1U1678B	1,102
16	84	Y-1R3G1U1684B	1,154

LEXAN 1/4" DAY-TO-DAY, CALIBRATE & BENCHING HAT WIDTH FRONT/REAR SURFACE MOUNT CLIP SCREENS WITHOUT CUT-OUTS

H	W	Model Number	List
20	24	Y-1R3G1U2024B	704
20	30	Y-1R3G1U2030B	766
20	36	Y-1R3G1U2036B	829
20	42	Y-1R3G1U2042B	890
20	48	Y-1R3G1U2048B	954
20	54	Y-1R3G1U2054B	1,017
20	60	Y-1R3G1U2060B	1,080
20	66	Y-1R3G1U2066B	1,141
20	72	Y-1R3G1U2072B	1,204
20	78	Y-1R3G1U2078B	1,267
20	84	Y-1R3G1U2084B	1,329

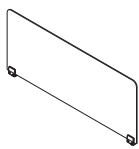

24 - 48 Wide

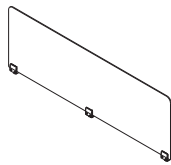

54 - 66 Wide

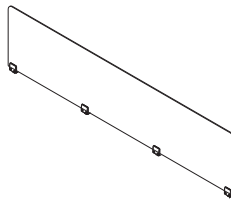

72 - 84 Wide

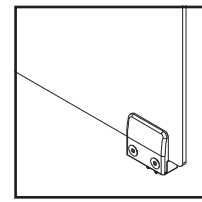

Surface Mount Clip

Specify

Notes

- Clips available in Metallic Silver only.
- Lexan available only in clear.

Lexan Day-to-Day, Calibrate & Benching HAT Width Front/Rear Surface Mount Clip Screens

Material	Where Used	Screen Type	Sized For	Mount Type
Lexan 1/4"	Front/Rear on Worksurface	Clip	Day-to-Day, Calibrate & Benching HAT Width	Surface Mount

LEXAN 1/4" DAY-TO-DAY, CALIBRATE & BENCHING HAT WIDTH FRONT/REAR SURFACE MOUNT CLIP SCREENS WITH CUT-OUTS

H	W	Model Number	List
12	24	Y-1R3G1U1224A	605
12	30	Y-1R3G1U1230A	642
12	36	Y-1R3G1U1236A	679
12	42	Y-1R3G1U1242A	717
12	48	Y-1R3G1U1248A	755
12	54	Y-1R3G1U1254A	791
12	60	Y-1R3G1U1260A	829
12	66	Y-1R3G1U1266A	867
12	72	Y-1R3G1U1272A	903
12	78	Y-1R3G1U1278A	939
12	84	Y-1R3G1U1284A	976
16	24	Y-1R3G1U1624A	655
16	30	Y-1R3G1U1630A	704
16	36	Y-1R3G1U1636A	755
16	42	Y-1R3G1U1642A	804
16	48	Y-1R3G1U1648A	855
16	54	Y-1R3G1U1654A	903
16	60	Y-1R3G1U1660A	954
16	66	Y-1R3G1U1666A	1,002
16	72	Y-1R3G1U1672A	1,052
16	78	Y-1R3G1U1678A	1,102
16	84	Y-1R3G1U1684A	1,154

LEXAN 1/4" DAY-TO-DAY, CALIBRATE & BENCHING HAT WIDTH FRONT/REAR SURFACE MOUNT CLIP SCREENS WITH CUT-OUTS

H	W	Model Number	List
20	24	Y-1R3G1U2024A	704
20	30	Y-1R3G1U2030A	766
20	36	Y-1R3G1U2036A	829
20	42	Y-1R3G1U2042A	890
20	48	Y-1R3G1U2048A	954
20	54	Y-1R3G1U2054A	1,017
20	60	Y-1R3G1U2060A	1,080
20	66	Y-1R3G1U2066A	1,141
20	72	Y-1R3G1U2072A	1,204
20	78	Y-1R3G1U2078A	1,267
20	84	Y-1R3G1U2084A	1,329

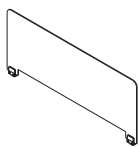

24 - 54 Wide

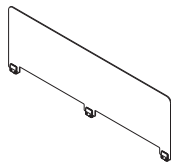

60 - 72 Wide

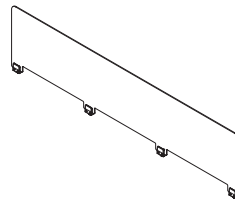

78 - 84 Wide

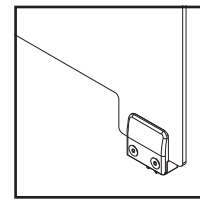

Surface Mount Clip

Specify

Notes

- Clips available in Metallic Silver only.
- Lexan available only in clear.

SCREENS

CLIP SCREENS FOR DAY-TO-DAY, CALIBRATE & BENCHING HAT WIDTHS

Glass Day-to-Day, Calibrate & Benching HAT Width Front/Rear Surface Mount Clip Screens

Material	Where Used	Screen Type	Sized For	Mount Type
Glass 1/4"	Front/Rear on Worksurface	Clip	Day-to-Day, Calibrate & Benching HAT Width	Surface Mount

GLASS 1/4" DAY-TO-DAY, CALIBRATE & BENCHING HAT WIDTH FRONT/REAR SURFACE MOUNT CLIP SCREENS

H	W	Model Number	List	Tinted Glass	Frosted Glass
12	24	Y-3R3G1U1224B	535	+30	+110
12	30	Y-3R3G1U1230B	542	+38	+138
12	36	Y-3R3G1U1236B	549	+45	+165
12	42	Y-3R3G1U1242B	578	+53	+193
12	48	Y-3R3G1U1248B	607	+60	+220
12	54	Y-3R3G1U1254B	727	+68	+248
12	60	Y-3R3G1U1260B	666	+75	+275
12	66	Y-3R3G1U1266B	695	+83	+303
12	72	Y-3R3G1U1272B	724	+90	+330
12	78	Y-3R3G1U1278B	753	+98	+358
12	84	Y-3R3G1U1284B	779	+105	+385
16	24	Y-3R3G1U1624B	661	+40	+147
16	30	Y-3R3G1U1630B	687	+50	+184
16	36	Y-3R3G1U1636B	727	+60	+220
16	42	Y-3R3G1U1642B	756	+70	+257
16	48	Y-3R3G1U1648B	789	+80	+294
16	54	Y-3R3G1U1654B	840	+90	+330
16	60	Y-3R3G1U1660B	887	+100	+367
16	66	Y-3R3G1U1666B	899	+110	+404
16	72	Y-3R3G1U1672B	920	+120	+440
16	78	Y-3R3G1U1678B	937	+130	+477
16	84	Y-3R3G1U1684B	954	+140	+514

GLASS 1/4" DAY-TO-DAY, CALIBRATE & BENCHING HAT WIDTH FRONT/REAR SURFACE MOUNT CLIP SCREENS

H	W	Model Number	List	Tinted Glass	Frosted Glass
20	24	Y-3R3G1U2024B	606	+50	+184
20	30	Y-3R3G1U2030B	659	+63	+230
20	36	Y-3R3G1U2036B	695	+75	+275
20	42	Y-3R3G1U2042B	765	+88	+321
20	48	Y-3R3G1U2048B	816	+100	+367
20	54	Y-3R3G1U2054B	869	+113	+413
20	60	Y-3R3G1U2060B	922	+125	+459
20	66	Y-3R3G1U2066B	975	+138	+505
20	72	Y-3R3G1U2072B	1,028	+150	+550
20	78	Y-3R3G1U2078B	1,082	+163	+596
20	84	Y-3R3G1U2084B	1,133	+175	+642
24	24	Y-3R3G1U2424B	647	+60	+220
24	30	Y-3R3G1U2430B	710	+75	+275
24	36	Y-3R3G1U2436B	773	+90	+330
24	42	Y-3R3G1U2442B	834	+105	+385
24	48	Y-3R3G1U2448B	897	+120	+440
24	54	Y-3R3G1U2454B	958	+135	+495
24	60	Y-3R3G1U2460B	1,021	+150	+550
24	66	Y-3R3G1U2466B	1,085	+165	+605
24	72	Y-3R3G1U2472B	1,145	+180	+660
24	78	Y-3R3G1U2478B	1,206	+195	+715
24	84	Y-3R3G1U2484B	1,267	+210	+770

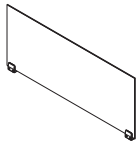

24 - 54 Wide

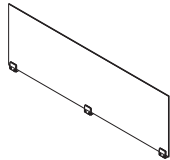

60 - 72 Wide

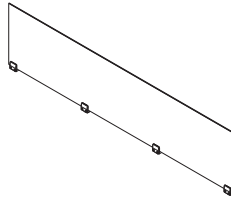

78 - 84 Wide

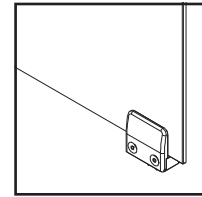

Surface Mount Clip

Specify

Notes

- Clips available in Metallic Silver only.
- Standard products for glass are always clear unless noted otherwise, other colors may be available upon special request (upcharges apply).

Glass Day-to-Day, Calibrate & Benching HAT Width Front/Rear Surface Mount Clip Screens

Material	Where Used	Screen Type	Sized For	Mount Type
Glass 3/8"	Front/Rear on Worksurface	Clip	Day-to-Day, Calibrate & Benching HAT Width	Surface Mount

GLASS 3/8" DAY-TO-DAY, CALIBRATE & BENCHING HAT WIDTH FRONT/REAR SURFACE MOUNT CLIP SCREENS

H	W	Model Number	List	Tinted Glass	Frosted Glass
12	24	Y-4R3G1U1224B	718	+30	+60
12	30	Y-4R3G1U1230B	722	+38	+75
12	36	Y-4R3G1U1236B	786	+45	+90
12	42	Y-4R3G1U1242B	848	+53	+105
12	48	Y-4R3G1U1248B	914	+60	+120
12	54	Y-4R3G1U1254B	979	+68	+135
12	60	Y-4R3G1U1260B	1,045	+75	+150
12	66	Y-4R3G1U1266B	1,109	+83	+165
12	72	Y-4R3G1U1272B	1,173	+90	+180
12	78	Y-4R3G1U1278B	1,239	+98	+195
12	84	Y-4R3G1U1284B	1,304	+105	+210
16	24	Y-4R3G1U1624B	684	+40	+80
16	30	Y-4R3G1U1630B	764	+50	+100
16	36	Y-4R3G1U1636B	801	+60	+120
16	42	Y-4R3G1U1642B	891	+70	+140
16	48	Y-4R3G1U1648B	988	+80	+160
16	54	Y-4R3G1U1654B	1,056	+90	+180
16	60	Y-4R3G1U1660B	1,087	+100	+200
16	66	Y-4R3G1U1666B	1,184	+110	+220
16	72	Y-4R3G1U1672B	1,258	+120	+240
16	78	Y-4R3G1U1678B	1,280	+130	+260
16	84	Y-4R3G1U1684B	1,344	+140	+280

GLASS 3/8" DAY-TO-DAY, CALIBRATE & BENCHING HAT WIDTH FRONT/REAR SURFACE MOUNT CLIP SCREENS

H	W	Model Number	List	Tinted Glass	Frosted Glass
20	24	Y-4R3G1U2024B	780	+50	+100
20	30	Y-4R3G1U2030B	884	+63	+125
20	36	Y-4R3G1U2036B	984	+75	+150
20	42	Y-4R3G1U2042B	1,086	+88	+175
20	48	Y-4R3G1U2048B	1,184	+100	+200
20	54	Y-4R3G1U2054B	1,287	+113	+225
20	60	Y-4R3G1U2060B	1,387	+125	+250
20	66	Y-4R3G1U2066B	1,489	+138	+275
20	72	Y-4R3G1U2072B	1,587	+150	+300
20	78	Y-4R3G1U2078B	1,687	+163	+325
20	84	Y-4R3G1U2084B	1,788	+175	+350
24	24	Y-4R3G1U2424B	855	+60	+120
24	30	Y-4R3G1U2430B	975	+75	+150
24	36	Y-4R3G1U2436B	1,093	+90	+180
24	42	Y-4R3G1U2442B	1,212	+105	+210
24	48	Y-4R3G1U2448B	1,331	+120	+240
24	54	Y-4R3G1U2454B	1,450	+135	+270
24	60	Y-4R3G1U2460B	1,571	+150	+300
24	66	Y-4R3G1U2466B	1,690	+165	+330
24	72	Y-4R3G1U2472B	1,807	+180	+360
24	78	Y-4R3G1U2478B	1,925	+195	+390
24	84	Y-4R3G1U2484B	2,044	+210	+420

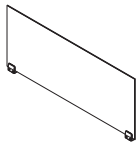

24 - 54 Wide

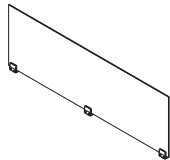

60 - 72 Wide

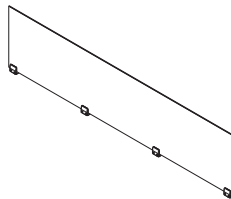

78 - 84 Wide

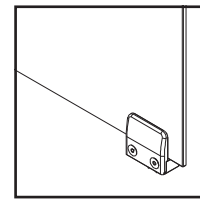

Surface Mount Clip

Specify

Notes

- Clips available in Metallic Silver only.
- Standard products for glass are always clear unless noted otherwise, other colors may be available upon special request (upcharges apply).

SCREENS

CLIP SCREENS FOR DAY-TO-DAY, CALIBRATE & BENCHING HAT WIDTHS

Lexan Day-to-Day, Calibrate & Benching HAT Width Front/Rear Under Surface Mount Clip Screens

Material	Where Used	Screen Type	Sized For	Mount Type
Lexan 1/4"	Front/Rear on Worksurface	Clip	Day-to-Day, Calibrate & Benching HAT Width	Under Surface Mount

LEXAN 1/4" DAY-TO-DAY, CALIBRATE & BENCHING HAT WIDTH FRONT/REAR UNDER SURFACE MOUNT CLIP SCREENS WITHOUT CUT-OUTS

H	W	Model Number	List
12	24	Y-1R3G2U1224B	605
12	30	Y-1R3G2U1230B	642
12	36	Y-1R3G2U1236B	679
12	42	Y-1R3G2U1242B	717
12	48	Y-1R3G2U1248B	755
12	54	Y-1R3G2U1254B	791
12	60	Y-1R3G2U1260B	829
12	66	Y-1R3G2U1266B	867
12	72	Y-1R3G2U1272B	903
12	78	Y-1R3G2U1278B	939
12	84	Y-1R3G2U1284B	976
16	24	Y-1R3G2U1624B	655
16	30	Y-1R3G2U1630B	704
16	36	Y-1R3G2U1636B	755
16	42	Y-1R3G2U1642B	804
16	48	Y-1R3G2U1648B	855
16	54	Y-1R3G2U1654B	903
16	60	Y-1R3G2U1660B	954
16	66	Y-1R3G2U1666B	1,002
16	72	Y-1R3G2U1672B	1,052
16	78	Y-1R3G2U1678B	1,102
16	84	Y-1R3G2U1684B	1,154

LEXAN 1/4" DAY-TO-DAY, CALIBRATE & BENCHING HAT WIDTH FRONT/REAR UNDER SURFACE MOUNT CLIP SCREENS WITHOUT CUT-OUTS

H	W	Model Number	List
20	24	Y-1R3G2U2024B	704
20	30	Y-1R3G2U2030B	766
20	36	Y-1R3G2U2036B	829
20	42	Y-1R3G2U2042B	890
20	48	Y-1R3G2U2048B	954
20	54	Y-1R3G2U2054B	1,017
20	60	Y-1R3G2U2060B	1,080
20	66	Y-1R3G2U2066B	1,141
20	72	Y-1R3G2U2072B	1,204
20	78	Y-1R3G2U2078B	1,267
20	84	Y-1R3G2U2084B	1,329

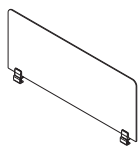

24 - 54 Wide

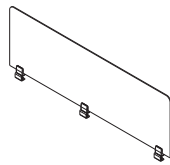

60 - 72 Wide

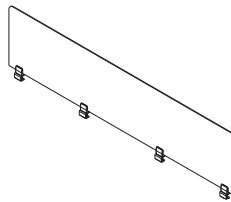

78 - 84 Wide

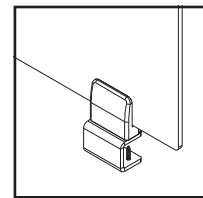

Under Surface Mount Clip

Specify

Notes

- Clips available in Metallic Silver only.
- Lexan available only in clear.

Lexan Day-to-Day, Calibrate & Benching HAT Width Front/Rear Under Surface Mount Clip Screens

Material	Where Used	Screen Type	Sized For	Mount Type
Lexan 1/4"	Front/Rear on Worksurface	Clip	Day-to-Day, Calibrate & Benching HAT Width	Under Surface Mount

LEXAN 1/4" DAY-TO-DAY, CALIBRATE & BENCHING HAT WIDTH FRONT/REAR UNDER SURFACE MOUNT CLIP SCREENS WITH CUT-OUTS

H	W	Model Number	List
12	24	Y-1R3G2U1224A	605
12	30	Y-1R3G2U1230A	642
12	36	Y-1R3G2U1236A	679
12	42	Y-1R3G2U1242A	717
12	48	Y-1R3G2U1248A	755
12	54	Y-1R3G2U1254A	791
12	60	Y-1R3G2U1260A	829
12	66	Y-1R3G2U1266A	867
12	72	Y-1R3G2U1272A	903
12	78	Y-1R3G2U1278A	939
12	84	Y-1R3G2U1284A	976
16	24	Y-1R3G2U1624A	655
16	30	Y-1R3G2U1630A	704
16	36	Y-1R3G2U1636A	755
16	42	Y-1R3G2U1642A	804
16	48	Y-1R3G2U1648A	855
16	54	Y-1R3G2U1654A	903
16	60	Y-1R3G2U1660A	954
16	66	Y-1R3G2U1666A	1,002
16	72	Y-1R3G2U1672A	1,052
16	78	Y-1R3G2U1678A	1,102
16	84	Y-1R3G2U1684A	1,154

LEXAN 1/4" DAY-TO-DAY, CALIBRATE & BENCHING HAT WIDTH FRONT/REAR UNDER SURFACE MOUNT CLIP SCREENS WITH CUT-OUTS

H	W	Model Number	List
20	24	Y-1R3G2U2024A	704
20	30	Y-1R3G2U2030A	766
20	36	Y-1R3G2U2036A	829
20	42	Y-1R3G2U2042A	890
20	48	Y-1R3G2U2048A	954
20	54	Y-1R3G2U2054A	1,017
20	60	Y-1R3G2U2060A	1,080
20	66	Y-1R3G2U2066A	1,141
20	72	Y-1R3G2U2072A	1,204
20	78	Y-1R3G2U2078A	1,267
20	84	Y-1R3G2U2084A	1,329

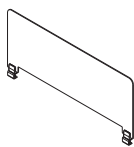

24 - 54 Wide

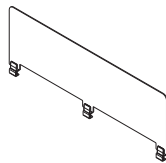

60 - 72 Wide

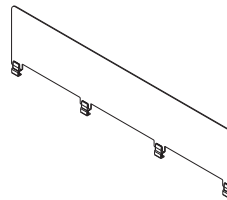

78 - 84 Wide

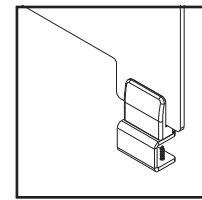

Under Surface Mount Clip

Specify

Notes

- Clips available in Metallic Silver only.
- Lexan available only in clear.

SCREENS

CLIP SCREENS FOR DAY-TO-DAY, CALIBRATE & BENCHING HAT WIDTHS

Glass Day-to-Day, Calibrate & Benching HAT Width Front/Rear Under Surface Mount Clip Screens

Material	Where Used	Screen Type	Sized For	Mount Type
Glass 1/4"	Front/Rear on Worksurface	Clip	Day-to-Day, Calibrate & Benching HAT Width	Under Surface Mount

GLASS 1/4" DAY-TO-DAY, CALIBRATE & BENCHING HAT WIDTH FRONT/REAR UNDER SURFACE MOUNT CLIP SCREENS

H	W	Model Number	List	Tinted Glass	Frosted Glass
12	24	Y-3R3G2U1224B	535	+30	+110
12	30	Y-3R3G2U1230B	542	+38	+138
12	36	Y-3R3G2U1236B	549	+45	+165
12	42	Y-3R3G2U1242B	578	+53	+193
12	48	Y-3R3G2U1248B	607	+60	+220
12	54	Y-3R3G2U1254B	727	+68	+248
12	60	Y-3R3G2U1260B	666	+75	+275
12	66	Y-3R3G2U1266B	695	+83	+303
12	72	Y-3R3G2U1272B	724	+90	+330
12	78	Y-3R3G2U1278B	753	+98	+358
12	84	Y-3R3G2U1284B	779	+105	+385
16	24	Y-3R3G2U1624B	661	+40	+147
16	30	Y-3R3G2U1630B	687	+50	+184
16	36	Y-3R3G2U1636B	727	+60	+220
16	42	Y-3R3G2U1642B	756	+70	+257
16	48	Y-3R3G2U1648B	789	+80	+294
16	54	Y-3R3G2U1654B	840	+90	+330
16	60	Y-3R3G2U1660B	887	+100	+367
16	66	Y-3R3G2U1666B	899	+110	+404
16	72	Y-3R3G2U1672B	920	+120	+440
16	78	Y-3R3G2U1678B	937	+130	+477
16	84	Y-3R3G2U1684B	954	+140	+514

GLASS 1/4" DAY-TO-DAY, CALIBRATE & BENCHING HAT WIDTH FRONT/REAR UNDER SURFACE MOUNT CLIP SCREENS

H	W	Model Number	List	Tinted Glass	Frosted Glass
20	24	Y-3R3G2U2024B	606	+50	+184
20	30	Y-3R3G2U2030B	659	+63	+230
20	36	Y-3R3G2U2036B	695	+75	+275
20	42	Y-3R3G2U2042B	765	+88	+321
20	48	Y-3R3G2U2048B	816	+100	+367
20	54	Y-3R3G2U2054B	869	+113	+413
20	60	Y-3R3G2U2060B	922	+125	+459
20	66	Y-3R3G2U2066B	975	+138	+505
20	72	Y-3R3G2U2072B	1,028	+150	+550
20	78	Y-3R3G2U2078B	1,082	+163	+596
20	84	Y-3R3G2U2084B	1,133	+175	+642
24	24	Y-3R3G2U2424B	647	+60	+220
24	30	Y-3R3G2U2430B	710	+75	+275
24	36	Y-3R3G2U2436B	773	+90	+330
24	42	Y-3R3G2U2442B	834	+105	+385
24	48	Y-3R3G2U2448B	897	+120	+440
24	54	Y-3R3G2U2454B	958	+135	+495
24	60	Y-3R3G2U2460B	1,021	+150	+550
24	66	Y-3R3G2U2466B	1,085	+165	+605
24	72	Y-3R3G2U2472B	1,145	+180	+660
24	78	Y-3R3G2U2478B	1,206	+195	+715
24	84	Y-3R3G2U2484B	1,267	+210	+770

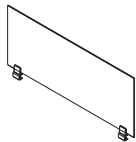

24 - 54 Wide

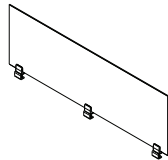

60 - 72 Wide

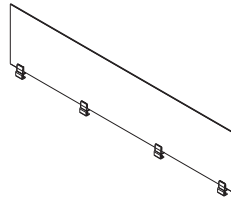

78 - 84 Wide

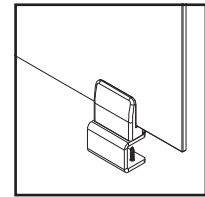

Under Surface Mount Clip

Specify

Notes

- Clips available in Metallic Silver only.
- Standard products for glass are always clear unless noted otherwise, other colors may be available upon special request (upcharges apply).

Glass Day-to-Day, Calibrate & Benching HAT Width Front/Rear Under Surface Mount Clip Screens

Material	Where Used	Screen Type	Sized For	Mount Type
Glass 3/8"	Front/Rear on Worksurface	Clip	Day-to-Day, Calibrate & Benching HAT Width	Under Surface Mount

GLASS 3/8" DAY-TO-DAY, CALIBRATE & BENCHING HAT WIDTH FRONT/REAR UNDER SURFACE MOUNT CLIP SCREENS

H	W	Model Number	List	Tinted Glass	Frosted Glass
12	24	Y-4R3G2U1224B	718	+30	+60
12	30	Y-4R3G2U1230B	722	+38	+75
12	36	Y-4R3G2U1236B	786	+45	+90
12	42	Y-4R3G2U1242B	848	+53	+105
12	48	Y-4R3G2U1248B	914	+60	+120
12	54	Y-4R3G2U1254B	979	+68	+135
12	60	Y-4R3G2U1260B	1,045	+75	+150
12	66	Y-4R3G2U1266B	1,109	+83	+165
12	72	Y-4R3G2U1272B	1,173	+90	+180
12	78	Y-4R3G2U1278B	1,239	+98	+195
12	84	Y-4R3G2U1284B	1,304	+105	+210
16	24	Y-4R3G2U1624B	684	+40	+80
16	30	Y-4R3G2U1630B	764	+50	+100
16	36	Y-4R3G2U1636B	801	+60	+120
16	42	Y-4R3G2U1642B	891	+70	+140
16	48	Y-4R3G2U1648B	988	+80	+160
16	54	Y-4R3G2U1654B	1,056	+90	+180
16	60	Y-4R3G2U1660B	1,087	+100	+200
16	66	Y-4R3G2U1666B	1,184	+110	+220
16	72	Y-4R3G2U1672B	1,258	+120	+240
16	78	Y-4R3G2U1678B	1,280	+130	+260
16	84	Y-4R3G2U1684B	1,344	+140	+280

GLASS 3/8" DAY-TO-DAY, CALIBRATE & BENCHING HAT WIDTH FRONT/REAR UNDER SURFACE MOUNT CLIP SCREENS

H	W	Model Number	List	Tinted Glass	Frosted Glass
20	24	Y-4R3G2U2024B	780	+50	+100
20	30	Y-4R3G2U2030B	884	+63	+125
20	36	Y-4R3G2U2036B	984	+75	+150
20	42	Y-4R3G2U2042B	1,086	+88	+175
20	48	Y-4R3G2U2048B	1,184	+100	+200
20	54	Y-4R3G2U2054B	1,287	+113	+225
20	60	Y-4R3G2U2060B	1,387	+125	+250
20	66	Y-4R3G2U2066B	1,489	+138	+275
20	72	Y-4R3G2U2072B	1,587	+150	+300
20	78	Y-4R3G2U2078B	1,687	+163	+325
20	84	Y-4R3G2U2084B	1,788	+175	+350
24	24	Y-4R3G2U2424B	855	+60	+120
24	30	Y-4R3G2U2430B	975	+75	+150
24	36	Y-4R3G2U2436B	1,093	+90	+180
24	42	Y-4R3G2U2442B	1,212	+105	+210
24	48	Y-4R3G2U2448B	1,331	+120	+240
24	54	Y-4R3G2U2454B	1,450	+135	+270
24	60	Y-4R3G2U2460B	1,571	+150	+300
24	66	Y-4R3G2U2466B	1,690	+165	+330
24	72	Y-4R3G2U2472B	1,807	+180	+360
24	78	Y-4R3G2U2478B	1,925	+195	+390
24	84	Y-4R3G2U2484B	2,044	+210	+420

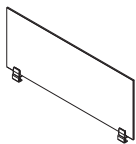

24 - 54 Wide

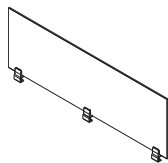

60 - 72 Wide

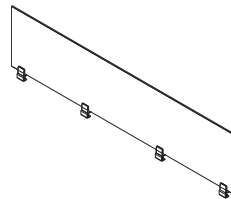

78 - 84 Wide

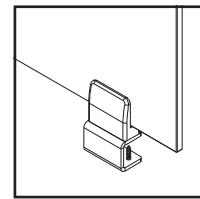

Under Surface Mount Clip

Specify

Notes

- Clips available in Metallic Silver only.
- Standard products for glass are always clear unless noted otherwise, other colors may be available upon special request (upcharges apply).

Lexan Day-to-Day, Calibrate & Benching HAT Width Front/Rear Freestanding Clip Screens

Material	Where Used	Screen Type	Sized For	Mount Type
Lexan 1/4"	Front/Rear on Worksurface	Clip	Day-to-Day, Calibrate & Benching HAT Width	Freestanding

LEXAN 1/4" DAY-TO-DAY, CALIBRATE & BENCHING HAT WIDTH FRONT/REAR FREESTANDING CLIP SCREENS WITHOUT CUT-OUTS

H	W	Model Number	List
12	24	Y-1R3G4U1224B	735
12	30	Y-1R3G4U1230B	771
12	36	Y-1R3G4U1236B	808
12	42	Y-1R3G4U1242B	846
12	48	Y-1R3G4U1248B	885
12	54	Y-1R3G4U1254B	921
12	60	Y-1R3G4U1260B	1,024
12	66	Y-1R3G4U1266B	1,061
12	72	Y-1R3G4U1272B	1,098
12	78	Y-1R3G4U1278B	1,199
12	84	Y-1R3G4U1284B	1,236
16	24	Y-1R3G4U1624B	786
16	30	Y-1R3G4U1630B	834
16	36	Y-1R3G4U1636B	885
16	42	Y-1R3G4U1642B	935
16	48	Y-1R3G4U1648B	985
16	54	Y-1R3G4U1654B	1,032
16	60	Y-1R3G4U1660B	1,149
16	66	Y-1R3G4U1666B	1,198
16	72	Y-1R3G4U1672B	1,248
16	78	Y-1R3G4U1678B	1,362
16	84	Y-1R3G4U1684B	1,414

LEXAN 1/4" DAY-TO-DAY, CALIBRATE & BENCHING HAT WIDTH FRONT/REAR FREESTANDING CLIP SCREENS WITHOUT CUT-OUTS

H	W	Model Number	List
20	24	Y-1R3G4U2024B	834
20	30	Y-1R3G4U2030B	897
20	36	Y-1R3G4U2036B	958
20	42	Y-1R3G4U2042B	1,021
20	48	Y-1R3G4U2048B	1,085
20	54	Y-1R3G4U2054B	1,146
20	60	Y-1R3G4U2060B	1,275
20	66	Y-1R3G4U2066B	1,335
20	72	Y-1R3G4U2072B	1,399
20	78	Y-1R3G4U2078B	1,527
20	84	Y-1R3G4U2084B	1,589

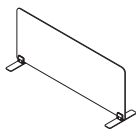

24 - 54 Wide

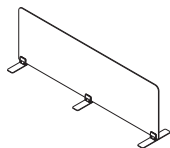

60 - 72 Wide

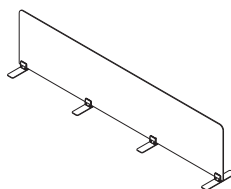

78 - 84 Wide

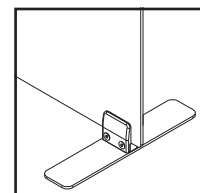

Freestanding Clip

Specify

Notes

- Clips available in Metallic Silver only.
- Lexan available only in clear.
- Non-marring feet measure 2 3/8" x 12".

Lexan Day-to-Day, Calibrate & Benching HAT Width Front/Rear Freestanding Clip Screens

Material	Where Used	Screen Type	Sized For	Mount Type
Lexan 1/4"	Front/Rear on Worksurface	Clip	Day-to-Day, Calibrate & Benching HAT Width	Freestanding

LEXAN 1/4" DAY-TO-DAY, CALIBRATE & BENCHING HAT WIDTH FRONT/REAR FREESTANDING CLIP SCREENS WITH CUT-OUTS

H	W	Model Number	List
12	24	Y-1R3G4U1224A	735
12	30	Y-1R3G4U1230A	771
12	36	Y-1R3G4U1236A	808
12	42	Y-1R3G4U1242A	846
12	48	Y-1R3G4U1248A	885
12	54	Y-1R3G4U1254A	921
12	60	Y-1R3G4U1260A	1,024
12	66	Y-1R3G4U1266A	1,061
12	72	Y-1R3G4U1272A	1,098
12	78	Y-1R3G4U1278A	1,199
12	84	Y-1R3G4U1284A	1,236
16	24	Y-1R3G4U1624A	786
16	30	Y-1R3G4U1630A	834
16	36	Y-1R3G4U1636A	885
16	42	Y-1R3G4U1642A	935
16	48	Y-1R3G4U1648A	985
16	54	Y-1R3G4U1654A	1,032
16	60	Y-1R3G4U1660A	1,149
16	66	Y-1R3G4U1666A	1,198
16	72	Y-1R3G4U1672A	1,248
16	78	Y-1R3G4U1678A	1,362
16	84	Y-1R3G4U1684A	1,414

LEXAN 1/4" DAY-TO-DAY, CALIBRATE & BENCHING HAT WIDTH FRONT/REAR FREESTANDING CLIP SCREENS WITH CUT-OUTS

H	W	Model Number	List
20	24	Y-1R3G4U2024A	834
20	30	Y-1R3G4U2030A	897
20	36	Y-1R3G4U2036A	958
20	42	Y-1R3G4U2042A	1,021
20	48	Y-1R3G4U2048A	1,085
20	54	Y-1R3G4U2054A	1,146
20	60	Y-1R3G4U2060A	1,275
20	66	Y-1R3G4U2066A	1,335
20	72	Y-1R3G4U2072A	1,399
20	78	Y-1R3G4U2078A	1,527
20	84	Y-1R3G4U2084A	1,589

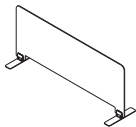

24 - 54 Wide

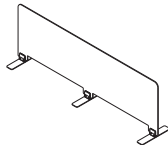

60 - 72 Wide

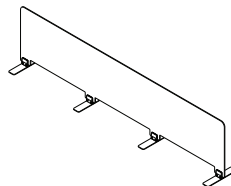

78 - 84 Wide

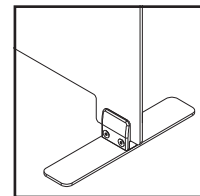

Freestanding Clip

Specify

Notes

- Clips available in Metallic Silver only.
- Lexan available only in clear.
- Non-marring feet measure 2 3/8" x 12".

SCREENS

LITE SCREENS FOR DAY-TO-DAY, CALIBRATE & BENCHING HAT WIDTHS

PET Day-to-Day, Calibrate & Benching HAT Width Front/Rear Surface Mount Lite Screens

Material	Where Used	Screen Type	Sized For	Mount Type
PET	Front/Rear on Worksurface	Lite	Day-to-Day, Calibrate & Benching HAT Width	Surface Mount

PET DAY-TO-DAY, CALIBRATE & BENCHING HAT WIDTH FRONT/REAR SURFACE MOUNT LITE SCREENS

H	W	Model Number	List
12	24	Y-5R4G1U1224B	494
12	30	Y-5R4G1U1230B	504
12	36	Y-5R4G1U1236B	512
12	42	Y-5R4G1U1242B	521
12	48	Y-5R4G1U1248B	533
12	54	Y-5R4G1U1254B	542
12	60	Y-5R4G1U1260B	549
12	66	Y-5R4G1U1266B	562
12	72	Y-5R4G1U1272B	571
12	78	Y-5R4G1U1278B	578
12	84	Y-5R4G1U1284B	589
16	24	Y-5R4G1U1624B	506
16	30	Y-5R4G1U1630B	518
16	36	Y-5R4G1U1636B	533
16	42	Y-5R4G1U1642B	544
16	48	Y-5R4G1U1648B	557
16	54	Y-5R4G1U1654B	571
16	60	Y-5R4G1U1660B	583
16	66	Y-5R4G1U1666B	596
16	72	Y-5R4G1U1672B	607
16	78	Y-5R4G1U1678B	619
16	84	Y-5R4G1U1684B	634

PET DAY-TO-DAY, CALIBRATE & BENCHING HAT WIDTH FRONT/REAR SURFACE MOUNT LITE SCREENS

H	W	Model Number	List
20	24	Y-5R4G1U2024B	518
20	30	Y-5R4G1U2030B	535
20	36	Y-5R4G1U2036B	549
20	42	Y-5R4G1U2042B	567
20	48	Y-5R4G1U2048B	583
20	54	Y-5R4G1U2054B	599
20	60	Y-5R4G1U2060B	614
20	66	Y-5R4G1U2066B	631
20	72	Y-5R4G1U2072B	646
20	78	Y-5R4G1U2078B	663
20	84	Y-5R4G1U2084B	678
24	24	Y-5R4G1U2424B	533
24	30	Y-5R4G1U2430B	549
24	36	Y-5R4G1U2436B	571
24	42	Y-5R4G1U2442B	589
24	48	Y-5R4G1U2448B	607
24	54	Y-5R4G1U2454B	627
24	60	Y-5R4G1U2460B	646
24	66	Y-5R4G1U2466B	666
24	72	Y-5R4G1U2472B	684
24	78	Y-5R4G1U2478B	704
24	84	Y-5R4G1U2484B	724

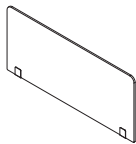

24 - 54 Wide

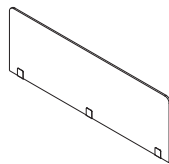

60 - 72 Wide

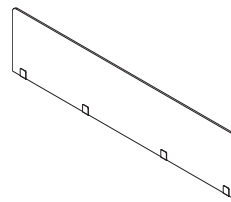

78 - 84 Wide

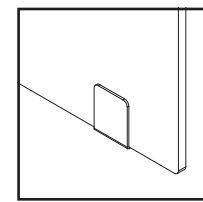

Under Surface Mount Lite

Specify

- Paint Selection (Grade C +10)
- Color Selection for PET - Lite Grey, Medium Grey, Tan or Vibrant Blue

Notes

- PET Territory Screens are designed to mount to AIS worksurfaces. Specify based on nominal size for the desired system. Order screens that correspond to worksurface width.
- PET screen inserts are 1/2" (12mm) thick.

PET Day-to-Day, Calibrate & Benching HAT Width Front/Rear Surface Mount Lite Screens

Material	Where Used	Screen Type	Sized For	Mount Type
PET	Front/Rear on Worksurface	Lite	Day-to-Day, Calibrate & Benching HAT Width	Surface Mount

PET DAY-TO-DAY, CALIBRATE & BENCHING HAT WIDTH FRONT/REAR SURFACE MOUNT LITE SCREENS

H	W	Model Number	List
28	24	Y-5R4G1U2824B	544
28	30	Y-5R4G1U2830B	567
28	36	Y-5R4G1U2836B	589
28	42	Y-5R4G1U2842B	612
28	48	Y-5R4G1U2848B	634
28	54	Y-5R4G1U2854B	656
28	60	Y-5R4G1U2860B	678
28	66	Y-5R4G1U2866B	700
28	72	Y-5R4G1U2872B	724
28	78	Y-5R4G1U2878B	746
28	84	Y-5R4G1U2884B	767
32	24	Y-5R4G1U3224B	557
32	30	Y-5R4G1U3230B	583
32	36	Y-5R4G1U3236B	607
32	42	Y-5R4G1U3242B	634
32	48	Y-5R4G1U3248B	659
32	54	Y-5R4G1U3254B	684
32	60	Y-5R4G1U3260B	710
32	66	Y-5R4G1U3266B	736
32	72	Y-5R4G1U3272B	761
32	78	Y-5R4G1U3278B	788
32	84	Y-5R4G1U3284B	810

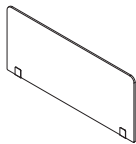

24 - 54 Wide

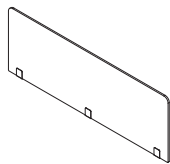

60 - 72 Wide

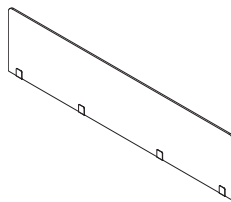

78 - 84 Wide

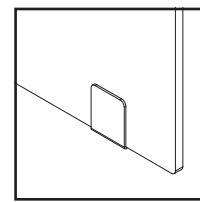

Under Surface Mount Lite

Specify

- Paint Selection (Grade C +10)
- Color Selection for PET - Lite Grey, Medium Grey, Tan or Vibrant Blue

Notes

- PET Territory Screens are designed to mount to AIS worksurfaces. Specify based on nominal size for the desired system. Order screens that correspond to worksurface width.
- PET screen inserts are 1/2" (12mm) thick.

SCREENS

LITE SCREENS FOR DAY-TO-DAY, CALIBRATE & BENCHING HAT WIDTHS

PET Day-to-Day, Calibrate & Benching HAT Width Front/Rear Under Surface Mount Lite Screens

Material	Where Used	Screen Type	Sized For	Mount Type
PET	Front/Rear on Worksurface	Lite	Day-to-Day, Calibrate & Benching HAT Width	Under Surface Mount

PET DAY-TO-DAY, CALIBRATE & BENCHING HAT WIDTH FRONT/REAR UNDER SURFACE MOUNT LITE SCREENS

H	W	Model Number	List
12	24	Y-5R4G2U1224B	494
12	30	Y-5R4G2U1230B	504
12	36	Y-5R4G2U1236B	512
12	42	Y-5R4G2U1242B	521
12	48	Y-5R4G2U1248B	533
12	54	Y-5R4G2U1254B	542
12	60	Y-5R4G2U1260B	549
12	66	Y-5R4G2U1266B	562
12	72	Y-5R4G2U1272B	571
12	78	Y-5R4G2U1278B	578
12	84	Y-5R4G2U1284B	589
16	24	Y-5R4G2U1624B	506
16	30	Y-5R4G2U1630B	518
16	36	Y-5R4G2U1636B	533
16	42	Y-5R4G2U1642B	544
16	48	Y-5R4G2U1648B	557
16	54	Y-5R4G2U1654B	571
16	60	Y-5R4G2U1660B	583
16	66	Y-5R4G2U1666B	596
16	72	Y-5R4G2U1672B	607
16	78	Y-5R4G2U1678B	619
16	84	Y-5R4G2U1684B	634

PET DAY-TO-DAY, CALIBRATE & BENCHING HAT WIDTH FRONT/REAR UNDER SURFACE MOUNT LITE SCREENS

H	W	Model Number	List
20	24	Y-5R4G2U2024B	518
20	30	Y-5R4G2U2030B	535
20	36	Y-5R4G2U2036B	549
20	42	Y-5R4G2U2042B	567
20	48	Y-5R4G2U2048B	583
20	54	Y-5R4G2U2054B	599
20	60	Y-5R4G2U2060B	614
20	66	Y-5R4G2U2066B	631
20	72	Y-5R4G2U2072B	646
20	78	Y-5R4G2U2078B	663
20	84	Y-5R4G2U2084B	678
24	24	Y-5R4G2U2424B	533
24	30	Y-5R4G2U2430B	549
24	36	Y-5R4G2U2436B	571
24	42	Y-5R4G2U2442B	589
24	48	Y-5R4G2U2448B	607
24	54	Y-5R4G2U2454B	627
24	60	Y-5R4G2U2460B	646
24	66	Y-5R4G2U2466B	666
24	72	Y-5R4G2U2472B	684
24	78	Y-5R4G2U2478B	704
24	84	Y-5R4G2U2484B	724

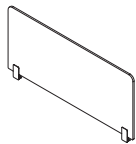

24 - 54 Wide

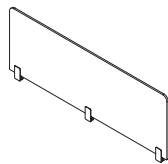

60 - 72 Wide

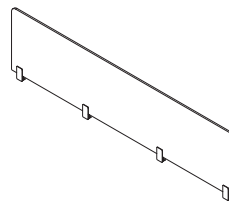

78 - 84 Wide

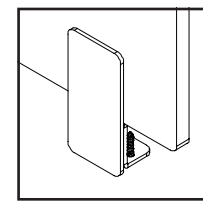

Under Surface Mount Lite

Specify

- Paint Selection (Grade C +10)
- Color Selection for PET - Lite Grey, Medium Grey, Tan or Vibrant Blue

Notes

- PET Territory Screens are designed to mount to AIS worksurfaces. Specify based on nominal size for the desired system. Order screens that correspond to worksurface width.
- PET screen inserts are 1/2" (12mm) thick.

PET Day-to-Day, Calibrate & Benching HAT Width Front/Rear Under Surface Mount Lite Screens

Material	Where Used	Screen Type	Sized For	Mount Type
PET	Front/Rear on Worksurface	Lite	Day-to-Day, Calibrate & Benching HAT Width	Under Surface Mount

PET DAY-TO-DAY, CALIBRATE & BENCHING HAT WIDTH FRONT/REAR UNDER SURFACE MOUNT LITE SCREENS

H	W	Model Number	List
28	24	Y-5R4G2U2824B	544
28	30	Y-5R4G2U2830B	567
28	36	Y-5R4G2U2836B	589
28	42	Y-5R4G2U2842B	612
28	48	Y-5R4G2U2848B	634
28	54	Y-5R4G2U2854B	656
28	60	Y-5R4G2U2860B	678
28	66	Y-5R4G2U2866B	700
28	72	Y-5R4G2U2872B	724
28	78	Y-5R4G2U2878B	746
28	84	Y-5R4G2U2884B	767
32	24	Y-5R4G2U3224B	557
32	30	Y-5R4G2U3230B	583
32	36	Y-5R4G2U3236B	607
32	42	Y-5R4G2U3242B	634
32	48	Y-5R4G2U3248B	659
32	54	Y-5R4G2U3254B	684
32	60	Y-5R4G2U3260B	710
32	66	Y-5R4G2U3266B	736
32	72	Y-5R4G2U3272B	761
32	78	Y-5R4G2U3278B	788
32	84	Y-5R4G2U3284B	810

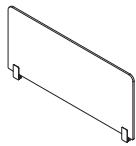

24 - 54 Wide

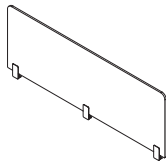

60 - 72 Wide

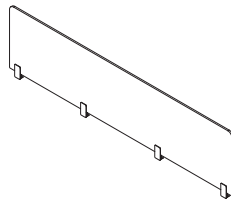

78 - 84 Wide

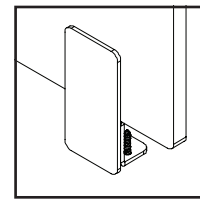

Under Surface Mount Lite

Specify

- Paint Selection (Grade C +10)
- Color Selection for PET - Lite Grey, Medium Grey, Tan or Vibrant Blue

Notes

- PET Territory Screens are designed to mount to AIS worksurfaces. Specify based on nominal size for the desired system. Order screens that correspond to worksurface width.
- PET screen inserts are 1/2" (12mm) thick.

PET Day-to-Day, Calibrate & Benching HAT Width Front/Rear Freestanding Lite Screens

Material	Where Used	Screen Type	Sized For	Mount Type
PET	Front/Rear on Worksurface	Lite	Day-to-Day, Calibrate & Benching HAT Width	Freestanding

PET DAY-TO-DAY, CALIBRATE & BENCHING HAT WIDTH FRONT/REAR FREESTANDING LITE SCREENS

H	W	Model Number	List
12	24	Y-5R4G4U1224B	624
12	30	Y-5R4G4U1230B	634
12	36	Y-5R4G4U1236B	643
12	42	Y-5R4G4U1242B	652
12	48	Y-5R4G4U1248B	663
12	54	Y-5R4G4U1254B	672
12	60	Y-5R4G4U1260B	746
12	66	Y-5R4G4U1266B	756
12	72	Y-5R4G4U1272B	765
12	78	Y-5R4G4U1278B	839
12	84	Y-5R4G4U1284B	848
16	24	Y-5R4G4U1624B	637
16	30	Y-5R4G4U1630B	648
16	36	Y-5R4G4U1636B	663
16	42	Y-5R4G4U1642B	674
16	48	Y-5R4G4U1648B	687
16	54	Y-5R4G4U1654B	699
16	60	Y-5R4G4U1660B	777
16	66	Y-5R4G4U1666B	791
16	72	Y-5R4G4U1672B	803
16	78	Y-5R4G4U1678B	880
16	84	Y-5R4G4U1684B	895

PET DAY-TO-DAY, CALIBRATE & BENCHING HAT WIDTH FRONT/REAR FREESTANDING LITE SCREENS

H	W	Model Number	List
20	24	Y-5R4G4U2024B	648
20	30	Y-5R4G4U2030B	665
20	36	Y-5R4G4U2036B	680
20	42	Y-5R4G4U2042B	697
20	48	Y-5R4G4U2048B	713
20	54	Y-5R4G4U2054B	728
20	60	Y-5R4G4U2060B	808
20	66	Y-5R4G4U2066B	827
20	72	Y-5R4G4U2072B	841
20	78	Y-5R4G4U2078B	922
20	84	Y-5R4G4U2084B	938
24	24	Y-5R4G4U2424B	663
24	30	Y-5R4G4U2430B	680
24	36	Y-5R4G4U2436B	699
24	42	Y-5R4G4U2442B	720
24	48	Y-5R4G4U2448B	737
24	54	Y-5R4G4U2454B	758
24	60	Y-5R4G4U2460B	841
24	66	Y-5R4G4U2466B	861
24	72	Y-5R4G4U2472B	879
24	78	Y-5R4G4U2478B	964
24	84	Y-5R4G4U2484B	984

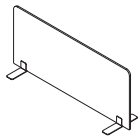

24 - 54 Wide

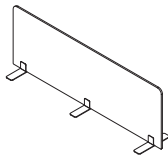

60 - 72 Wide

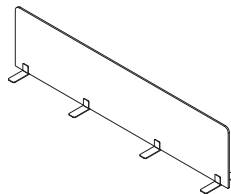

78 - 84 Wide

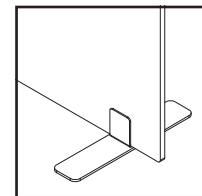

Freestanding Lite

Specify

- Paint Selection (Grade C +10)
- Color Selection for PET - Lite Grey, Medium Grey, Tan or Vibrant Blue

Notes

- PET Territory Screens are designed to mount to AIS worksurfaces. Specify based on nominal size for the desired system. Order screens that correspond to worksurface width.
- PET screen inserts are 1/2" (12mm) thick.
- Non-marring feet measure 2 3/8" x 12".

PET Day-to-Day, Calibrate & Benching HAT Width Front/Rear Freestanding Lite Screens

Material	Where Used	Screen Type	Sized For	Mount Type
PET	Front/Rear on Worksurface	Lite	Day-to-Day, Calibrate & Benching HAT Width	Freestanding

PET DAY-TO-DAY, CALIBRATE & BENCHING HAT WIDTH FRONT/REAR FREESTANDING LITE SCREENS

H	W	Model Number	List
28	24	Y-5R4G4U2824B	674
28	30	Y-5R4G4U2830B	697
28	36	Y-5R4G4U2836B	720
28	42	Y-5R4G4U2842B	740
28	48	Y-5R4G4U2848B	764
28	54	Y-5R4G4U2854B	787
28	60	Y-5R4G4U2860B	873
28	66	Y-5R4G4U2866B	897
28	72	Y-5R4G4U2872B	918
28	78	Y-5R4G4U2878B	1,006
28	84	Y-5R4G4U2884B	1,028
32	24	Y-5R4G4U3224B	687
32	30	Y-5R4G4U3230B	713
32	36	Y-5R4G4U3236B	737
32	42	Y-5R4G4U3242B	764
32	48	Y-5R4G4U3248B	790
32	54	Y-5R4G4U3254B	814
32	60	Y-5R4G4U3260B	906
32	66	Y-5R4G4U3266B	931
32	72	Y-5R4G4U3272B	956
32	78	Y-5R4G4U3278B	1,048
32	84	Y-5R4G4U3284B	1,071

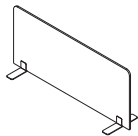

24 - 54 Wide

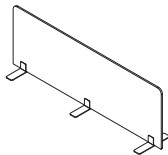

60 - 72 Wide

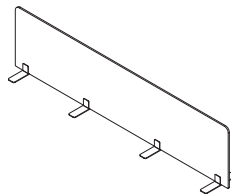

78 - 84 Wide

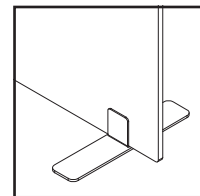

Freestanding Lite

Specify

- Paint Selection (Grade C +10)
- Color Selection for PET - Lite Grey, Medium Grey, Tan or Vibrant Blue

Notes

- PET Territory Screens are designed to mount to AIS worksurfaces. Specify based on nominal size for the desired system. Order screens that correspond to worksurface width.
- PET screen inserts are 1/2" (12mm) thick.
- Non-marring feet measure 2 3/8" x 12".

SCREENS

SLIMLINE SCREENS FOR DAY-TO-DAY, CALIBRATE & BENCHING HAT WIDTHS

Day-to-Day, Calibrate & Benching HAT Width Front/Rear Surface Mount Slimline Screens

Material	Where Used	Screen Type	Sized For	Mount Type
Fabric/Vinyl/Whiteboard/Laminate	Front/Rear on Worksurface	Slimline	Day-to-Day, Calibrate & Benching HAT Width	Surface Mount

PET DAY-TO-DAY, CALIBRATE & BENCHING HAT WIDTH FRONT/REAR SURFACE MOUNT SLIMLINE SCREENS

H	W	Model Number	List	Fabric Grade C	Fabric Grade D
12	36	Y-6R1G1U1236B	582	+7	+14
12	42	Y-6R1G1U1242B	613	+7	+14
12	48	Y-6R1G1U1248B	645	+7	+14
12	54	Y-6R1G1U1254B	678	+7	+14
12	60	Y-6R1G1U1260B	709	+7	+14
12	66	Y-6R1G1U1266B	920	+7	+14
12	72	Y-6R1G1U1272B	979	+7	+14
16	36	Y-6R1G1U1636B	650	+11	+22
16	42	Y-6R1G1U1642B	685	+11	+22
16	48	Y-6R1G1U1648B	722	+11	+22
16	54	Y-6R1G1U1654B	758	+11	+22
16	60	Y-6R1G1U1660B	793	+11	+22
16	66	Y-6R1G1U1666B	972	+11	+22
16	72	Y-6R1G1U1672B	1,032	+11	+22
20	36	Y-6R1G1U2036B	720	+15	+30
20	42	Y-6R1G1U2042B	759	+15	+30
20	48	Y-6R1G1U2048B	798	+15	+30
20	54	Y-6R1G1U2054B	835	+15	+30
20	60	Y-6R1G1U2060B	874	+15	+30
20	66	Y-6R1G1U2066B	1,022	+15	+30
20	72	Y-6R1G1U2072B	1,088	+15	+30

PET DAY-TO-DAY, CALIBRATE & BENCHING HAT WIDTH FRONT/REAR SURFACE MOUNT SLIMLINE SCREENS

H	W	Model Number	List	Fabric Grade C	Fabric Grade D
24	36	Y-6R1G1U2436B	789	+18	+36
24	42	Y-6R1G1U2442B	831	+18	+36
24	48	Y-6R1G1U2448B	874	+18	+36
24	54	Y-6R1G1U2454B	912	+18	+36
24	60	Y-6R1G1U2460B	956	+18	+36
24	66	Y-6R1G1U2466B	1,071	+18	+36
24	72	Y-6R1G1U2472B	1,141	+18	+36
28	36	Y-6R1G1U2836B	858	+21	+42
28	42	Y-6R1G1U2842B	904	+21	+42
28	48	Y-6R1G1U2848B	951	+21	+42
28	54	Y-6R1G1U2854B	991	+21	+42
28	60	Y-6R1G1U2860B	1,037	+21	+42
28	66	Y-6R1G1U2866B	1,122	+21	+42
28	72	Y-6R1G1U2872B	1,197	+21	+42

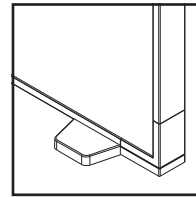
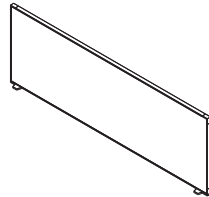

Surface Mount Slimline

Specify

- Paint Selection (Grade C +10)
- Fabric, Vinyl, Whiteboard or Laminate Selection

Notes

- Slimline screens may be fabric, vinyl, whiteboard or laminate on either side. Upcharges for Grade C and D are listed per side. Whiteboards are standard list and have no upcharge.
- Offered in all AIS paint finishes.

Day-to-Day, Calibrate & Benching HAT Width Front/Rear Under Surface Mount Slimline Screens

Material	Where Used	Screen Type	Sized For	Mount Type
Fabric/Vinyl/Whiteboard/Laminate	Front/Rear on Worksurface	Slimline	Day-to-Day, Calibrate & Benching HAT Width	Under Surface Mount

PET DAY-TO-DAY, CALIBRATE & BENCHING HAT WIDTH FRONT/REAR UNDER SURFACE MOUNT SLIMLINE SCREENS

H	W	Model Number	List	Fabric Grade C	Fabric Grade D
12	36	T-SWMR1236	582	+7	+14
12	42	T-SWMR1242	614	+7	+14
12	48	T-SWMR1248	645	+7	+14
12	54	T-SWMR1254	678	+7	+14
12	60	T-SWMR1260	709	+7	+14
12	66	T-SWMR1266	920	+7	+14
12	72	T-SWMR1272	979	+7	+14
16	36	T-SWMR1636	650	+11	+22
16	42	T-SWMR1642	685	+11	+22
16	48	T-SWMR1648	722	+11	+22
16	54	T-SWMR1654	758	+11	+22
16	60	T-SWMR1660	793	+11	+22
16	66	T-SWMR1666	972	+11	+22
16	72	T-SWMR1672	1,032	+11	+22
20	36	T-SWMR2036	720	+15	+30
20	42	T-SWMR2042	759	+15	+30
20	48	T-SWMR2048	798	+15	+30
20	54	T-SWMR2054	835	+15	+30
20	60	T-SWMR2060	874	+15	+30
20	66	T-SWMR2066	1,022	+15	+30
20	72	T-SWMR2072	1,088	+15	+30

PET DAY-TO-DAY, CALIBRATE & BENCHING HAT WIDTH FRONT/REAR UNDER SURFACE MOUNT SLIMLINE SCREENS

H	W	Model Number	List	Fabric Grade C	Fabric Grade D
24	36	T-SWMR2436	789	+18	+36
24	42	T-SWMR2442	831	+18	+36
24	48	T-SWMR2448	874	+18	+36
24	54	T-SWMR2454	912	+18	+36
24	60	T-SWMR2460	956	+18	+36
24	66	T-SWMR2466	1,071	+18	+36
24	72	T-SWMR2472	1,141	+18	+36
28	36	T-SWMR2836	858	+21	+42
28	42	T-SWMR2842	904	+21	+42
28	48	T-SWMR2848	951	+21	+42
28	54	T-SWMR2854	991	+21	+42
28	60	T-SWMR2860	1,037	+21	+42
28	66	T-SWMR2866	1,122	+21	+42
28	72	T-SWMR2872	1,197	+21	+42

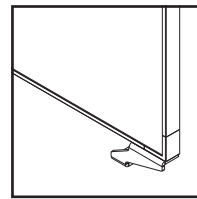
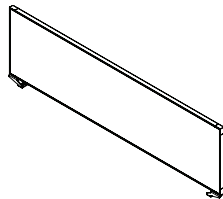

Under Surface Mount Slimline

Specify

- Paint Selection (Grade C +10)
- Fabric, Vinyl, Whiteboard or Laminate Selection

Notes

- Slimline screens may be fabric, vinyl, whiteboard or laminate on either side. Upcharges for Grade C and D are listed per side. Whiteboards are standard list and have no upcharge.
- Offered in all AIS paint finishes.

SCREENS

SLIMLINE SCREENS FOR DAY-TO-DAY, CALIBRATE & BENCHING HAT WIDTHS

Day-to-Day, Calibrate & Benching HAT Width Front/Rear Freestanding Slimline Screens

Material	Where Used	Screen Type	Sized For	Mount Type
Fabric/Vinyl/Whiteboard/Laminate	Front/Rear on Worksurface	Slimline	Day-to-Day, Calibrate & Benching HAT Width	Freestanding

PET DAY-TO-DAY, CALIBRATE & BENCHING HAT WIDTH FREESTANDING SLIMLINE SCREENS

H	W	Model Number	List	Fabric Grade C	Fabric Grade D
12	36	Y-6R1G4U1236B	582	+7	+14
12	42	Y-6R1G4U1242B	613	+7	+14
12	48	Y-6R1G4U1248B	645	+7	+14
12	54	Y-6R1G4U1254B	678	+7	+14
12	60	Y-6R1G4U1260B	709	+7	+14
12	66	Y-6R1G4U1266B	920	+7	+14
12	72	Y-6R1G4U1272B	979	+7	+14
16	36	Y-6R1G4U1636B	650	+11	+22
16	42	Y-6R1G4U1642B	685	+11	+22
16	48	Y-6R1G4U1648B	722	+11	+22
16	54	Y-6R1G4U1654B	758	+11	+22
16	60	Y-6R1G4U1660B	793	+11	+22
16	66	Y-6R1G4U1666B	972	+11	+22
16	72	Y-6R1G4U1672B	1,032	+11	+22
20	36	Y-6R1G4U2036B	720	+15	+30
20	42	Y-6R1G4U2042B	759	+15	+30
20	48	Y-6R1G4U2048B	798	+15	+30
20	54	Y-6R1G4U2054B	835	+15	+30
20	60	Y-6R1G4U2060B	874	+15	+30
20	66	Y-6R1G4U2066B	1,022	+15	+30
20	72	Y-6R1G4U2072B	1,088	+15	+30

PET DAY-TO-DAY, CALIBRATE & BENCHING HAT WIDTH FREESTANDING SLIMLINE SCREENS

H	W	Model Number	List	Fabric Grade C	Fabric Grade D
24	36	Y-6R1G4U2436B	789	+18	+36
24	42	Y-6R1G4U2442B	831	+18	+36
24	48	Y-6R1G4U2448B	874	+18	+36
24	54	Y-6R1G4U2454B	912	+18	+36
24	60	Y-6R1G4U2460B	956	+18	+36
24	66	Y-6R1G4U2466B	1,071	+18	+36
24	72	Y-6R1G4U2472B	1,141	+18	+36
28	36	Y-6R1G4U2836B	858	+21	+42
28	42	Y-6R1G4U2842B	904	+21	+42
28	48	Y-6R1G4U2848B	951	+21	+42
28	54	Y-6R1G4U2854B	991	+21	+42
28	60	Y-6R1G4U2860B	1,037	+21	+42
28	66	Y-6R1G4U2866B	1,122	+21	+42
28	72	Y-6R1G4U2872B	1,197	+21	+42

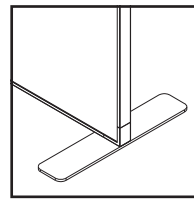
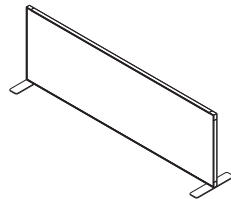

Freestanding Slimline

Specify

- Paint Selection (Grade C +10)
- Fabric, Vinyl, Whiteboard or Laminate Selection

Notes

- Slimline screens may be fabric, vinyl, whiteboard or laminate on either side. Upcharges for Grade C and D are listed per side. Whiteboards are standard list and have no upcharge.
- Offered in all AIS paint finishes.
- Non-marring feet measure 2 3/8" x 12".

Screens Sized for Aloft Worksurface Widths

Lexan Aloft Worksurface Width Front/Rear Surface Mount Channel Screens

Material	Where Used	Screen Type	Sized For	Mount Type
Lexan 1/4"	Front/Rear on Worksurface	Channel	Aloft WS Width	Surface Mount

LEXAN 1/4" ALOFT WORKSURFACE WIDTH FRONT/REAR SURFACE MOUNT CHANNEL SCREENS

H	W	Model Number	List
12	24	Y-1R2H1U1224B	605
12	30	Y-1R2H1U1230B	642
12	36	Y-1R2H1U1236B	679
12	42	Y-1R2H1U1242B	717
12	48	Y-1R2H1U1248B	755
12	54	Y-1R2H1U1254B	791
12	60	Y-1R2H1U1260B	829
12	66	Y-1R2H1U1266B	867
12	72	Y-1R2H1U1272B	903
12	78	Y-1R2H1U1278B	939
12	84	Y-1R2H1U1284B	976
16	24	Y-1R2H1U1624B	655
16	30	Y-1R2H1U1630B	704
16	36	Y-1R2H1U1636B	755
16	42	Y-1R2H1U1642B	804
16	48	Y-1R2H1U1648B	855
16	54	Y-1R2H1U1654B	903
16	60	Y-1R2H1U1660B	954
16	66	Y-1R2H1U1666B	1,002
16	72	Y-1R2H1U1672B	1,052
16	78	Y-1R2H1U1678B	1,102
16	84	Y-1R2H1U1684B	1,154

LEXAN 1/4" ALOFT WORKSURFACE WIDTH FRONT/REAR SURFACE MOUNT CHANNEL SCREENS

H	W	Model Number	List
20	24	Y-1R2H1U2024B	704
20	30	Y-1R2H1U2030B	766
20	36	Y-1R2H1U2036B	829
20	42	Y-1R2H1U2042B	890
20	48	Y-1R2H1U2048B	954
20	54	Y-1R2H1U2054B	1,017
20	60	Y-1R2H1U2060B	1,080
20	66	Y-1R2H1U2066B	1,141
20	72	Y-1R2H1U2072B	1,204
20	78	Y-1R2H1U2078B	1,267
20	84	Y-1R2H1U2084B	1,329

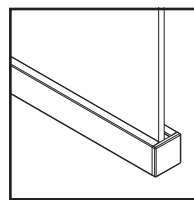
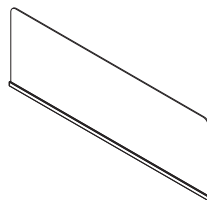

Surface Mount Channel

Specify

• Paint Selection (Grade C +10)

Notes

- Offered in all AIS paint finishes.
- Lexan available only in clear.

Glass Aloft Worksurface Width Front/Rear Surface Mount Channel Screens

Material	Where Used	Screen Type	Sized For	Mount Type
Glass 1/4"	Front/Rear on Worksurface	Channel	Aloft WS Width	Surface Mount

GLASS 1/4" ALOFT WORKSURFACE WIDTH FRONT/REAR SURFACE MOUNT CHANNEL SCREENS

H	W	Model Number	List	Tinted Glass	Frosted Glass
12	24	Y-3R2H1U1224B	535	+30	+110
12	30	Y-3R2H1U1230B	542	+38	+138
12	36	Y-3R2H1U1236B	549	+45	+165
12	42	Y-3R2H1U1242B	578	+53	+193
12	48	Y-3R2H1U1248B	607	+60	+220
12	54	Y-3R2H1U1254B	727	+68	+248
12	60	Y-3R2H1U1260B	666	+75	+275
12	66	Y-3R2H1U1266B	695	+83	+303
12	72	Y-3R2H1U1272B	724	+90	+330
12	78	Y-3R2H1U1278B	753	+98	+358
12	84	Y-3R2H1U1284B	779	+105	+385
16	24	Y-3R2H1U1624B	661	+40	+147
16	30	Y-3R2H1U1630B	687	+50	+184
16	36	Y-3R2H1U1636B	727	+60	+220
16	42	Y-3R2H1U1642B	756	+70	+257
16	48	Y-3R2H1U1648B	789	+80	+294
16	54	Y-3R2H1U1654B	840	+90	+330
16	60	Y-3R2H1U1660B	887	+100	+367
16	66	Y-3R2H1U1666B	899	+110	+404
16	72	Y-3R2H1U1672B	920	+120	+440
16	78	Y-3R2H1U1678B	937	+130	+477
16	84	Y-3R2H1U1684B	954	+140	+514

GLASS 1/4" ALOFT WORKSURFACE WIDTH FRONT/REAR SURFACE MOUNT CHANNEL SCREENS

H	W	Model Number	List	Tinted Glass	Frosted Glass
20	24	Y-3R2H1U2024B	606	+50	+184
20	30	Y-3R2H1U2030B	659	+63	+230
20	36	Y-3R2H1U2036B	695	+75	+275
20	42	Y-3R2H1U2042B	765	+88	+321
20	48	Y-3R2H1U2048B	816	+100	+367
20	54	Y-3R2H1U2054B	869	+113	+413
20	60	Y-3R2H1U2060B	922	+125	+459
20	66	Y-3R2H1U2066B	975	+138	+505
20	72	Y-3R2H1U2072B	1,028	+150	+550
20	78	Y-3R2H1U2078B	1,082	+163	+596
20	84	Y-3R2H1U2084B	1,133	+175	+642
24	24	Y-3R2H1U2424B	647	+60	+220
24	30	Y-3R2H1U2430B	710	+75	+275
24	36	Y-3R2H1U2436B	773	+90	+330
24	42	Y-3R2H1U2442B	834	+105	+385
24	48	Y-3R2H1U2448B	897	+120	+440
24	54	Y-3R2H1U2454B	958	+135	+495
24	60	Y-3R2H1U2460B	1,021	+150	+550
24	66	Y-3R2H1U2466B	1,085	+165	+605
24	72	Y-3R2H1U2472B	1,145	+180	+660
24	78	Y-3R2H1U2478B	1,206	+195	+715
24	84	Y-3R2H1U2484B	1,267	+210	+770

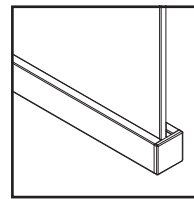
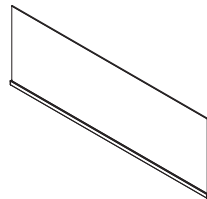

Surface Mount Channel

Specify

• Paint Selection (Grade C +10)

Notes

• Offered in all AIS paint finishes.

• Standard products for glass are always clear unless noted otherwise, other colors may be available upon special request (upcharges apply).

Glass Aloft Worksurface Width Front/Rear Surface Mount Channel Screens

Material	Where Used	Screen Type	Sized For	Mount Type
Glass 3/8"	Front/Rear on Worksurface	Channel	Aloft WS Width	Surface Mount

GLASS 3/8" ALOFT WORKSURFACE WIDTH FRONT/REAR SURFACE MOUNT CHANNEL SCREENS

H	W	Model Number	List	Tinted Glass	Frosted Glass
12	24	Y-4R2H1U1224B	718	+30	+60
12	30	Y-4R2H1U1230B	722	+38	+75
12	36	Y-4R2H1U1236B	786	+45	+90
12	42	Y-4R2H1U1242B	848	+53	+105
12	48	Y-4R2H1U1248B	914	+60	+120
12	54	Y-4R2H1U1254B	979	+68	+135
12	60	Y-4R2H1U1260B	1,045	+75	+150
12	66	Y-4R2H1U1266B	1,109	+83	+165
12	72	Y-4R2H1U1272B	1,173	+90	+180
12	78	Y-4R2H1U1278B	1,239	+98	+195
12	84	Y-4R2H1U1284B	1,304	+105	+210
16	24	Y-4R2H1U1624B	684	+40	+80
16	30	Y-4R2H1U1630B	764	+50	+100
16	36	Y-4R2H1U1636B	801	+60	+120
16	42	Y-4R2H1U1642B	891	+70	+140
16	48	Y-4R2H1U1648B	988	+80	+160
16	54	Y-4R2H1U1654B	1,056	+90	+180
16	60	Y-4R2H1U1660B	1,087	+100	+200
16	66	Y-4R2H1U1666B	1,184	+110	+220
16	72	Y-4R2H1U1672B	1,258	+120	+240
16	78	Y-4R2H1U1678B	1,280	+130	+260
16	84	Y-4R2H1U1684B	1,344	+140	+280

GLASS 3/8" ALOFT WORKSURFACE WIDTH FRONT/REAR SURFACE MOUNT CHANNEL SCREENS

H	W	Model Number	List	Tinted Glass	Frosted Glass
20	24	Y-4R2H1U2024B	780	+50	+100
20	30	Y-4R2H1U2030B	884	+63	+125
20	36	Y-4R2H1U2036B	984	+75	+150
20	42	Y-4R2H1U2042B	1,086	+88	+175
20	48	Y-4R2H1U2048B	1,184	+100	+200
20	54	Y-4R2H1U2054B	1,287	+113	+225
20	60	Y-4R2H1U2060B	1,387	+125	+250
20	66	Y-4R2H1U2066B	1,489	+138	+275
20	72	Y-4R2H1U2072B	1,587	+150	+300
20	78	Y-4R2H1U2078B	1,687	+163	+325
20	84	Y-4R2H1U2084B	1,788	+175	+350
24	24	Y-4R2H1U2424B	855	+60	+120
24	30	Y-4R2H1U2430B	975	+75	+150
24	36	Y-4R2H1U2436B	1,093	+90	+180
24	42	Y-4R2H1U2442B	1,212	+105	+210
24	48	Y-4R2H1U2448B	1,331	+120	+240
24	54	Y-4R2H1U2454B	1,450	+135	+270
24	60	Y-4R2H1U2460B	1,571	+150	+300
24	66	Y-4R2H1U2466B	1,690	+165	+330
24	72	Y-4R2H1U2472B	1,807	+180	+360
24	78	Y-4R2H1U2478B	1,925	+195	+390
24	84	Y-4R2H1U2484B	2,044	+210	+420

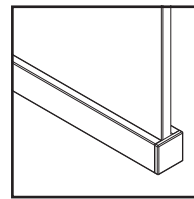
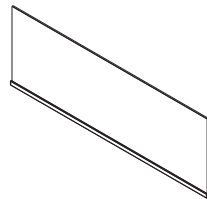

Surface Mount Channel

Specify

• Paint Selection (Grade C +10)

Notes

- Offered in all AIS paint finishes.
- Standard products for glass are always clear unless noted otherwise, other colors may be available upon special request (upcharges apply).

Glass Aloft 120 HAT Width Front/Rear Surface Mount Channel Screens

Material	Where Used	Screen Type	Sized For	Mount Type
Glass 3/8"	Front/Rear on Worksurface	Channel	Aloft 120 HAT Width	Surface Mount

GLASS 3/8" ALOFT 120 HAT WIDTH FRONT/REAR SURFACE MOUNT CHANNEL SCREENS

H	W	Model Number	Clear Glass	Frosted Glass
12	36	B-SSG120-1236	786	+137
12	42	B-SSG120-1242	848	+166
12	48	B-SSG120-1248	914	+194
12	54	B-SSG120-1254	979	+224
12	60	B-SSG120-1260	1,045	+252
16	36	B-SSG120-1636	801	+178
16	42	B-SSG120-1642	891	+214
16	48	B-SSG120-1648	988	+249
16	54	B-SSG120-1654	1,056	+286
16	60	B-SSG120-1660	1,087	+322

GLASS 3/8" ALOFT 120 HAT WIDTH FRONT/REAR SURFACE MOUNT CHANNEL SCREENS

H	W	Model Number	Clear Glass	Frosted Glass
20	36	B-SSG120-2036	984	+219
20	42	B-SSG120-2042	1,086	+262
20	48	B-SSG120-2048	1,184	+305
20	54	B-SSG120-2054	1,287	+348
20	60	B-SSG120-2060	1,387	+390
24	36	B-SSG120-2436	1,350	+260
24	42	B-SSG120-2442	1,542	+310
24	48	B-SSG120-2448	1,724	+361
24	54	B-SSG120-2454	1,913	+410
24	60	B-SSG120-2460	2,103	+458

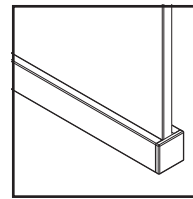
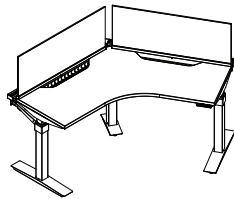
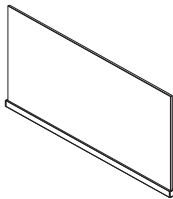

Surface Mount Channel

Specify

- Paint Selection (Grade C +10)
- Glass Selection

Notes

- For use with Aloft 120 benches only.
- Offered in all AIS paint finishes.
- Standard products for glass are always clear unless noted otherwise, other colors may be available upon special request (upcharges apply).

PET Aloft Worksurface Width Front/Rear Surface Mount Channel Screens

Material	Where Used	Screen Type	Sized For	Mount Type
PET	Front/Rear on Worksurface	Channel	Aloft WS Width	Surface Mount

**PET ALOFT WORKSURFACE WIDTH
FRONT/REAR SURFACE MOUNT CHANNEL SCREENS**

H	W	Model Number	List
12	24	Y-5R2H1U1224B	464
12	30	Y-5R2H1U1230B	480
12	36	Y-5R2H1U1236B	497
12	42	Y-5R2H1U1242B	512
12	48	Y-5R2H1U1248B	531
12	54	Y-5R2H1U1254B	546
12	60	Y-5R2H1U1260B	563
12	66	Y-5R2H1U1266B	578
12	72	Y-5R2H1U1272B	594
12	78	Y-5R2H1U1278B	612
12	84	Y-5R2H1U1284B	627
16	24	Y-5R2H1U1624B	485
16	30	Y-5R2H1U1630B	507
16	36	Y-5R2H1U1636B	531
16	42	Y-5R2H1U1642B	551
16	48	Y-5R2H1U1648B	574
16	54	Y-5R2H1U1654B	594
16	60	Y-5R2H1U1660B	616
16	66	Y-5R2H1U1666B	639
16	72	Y-5R2H1U1672B	661
16	78	Y-5R2H1U1678B	683
16	84	Y-5R2H1U1684B	705

**PET ALOFT WORKSURFACE WIDTH
FRONT/REAR SURFACE MOUNT CHANNEL SCREENS**

H	W	Model Number	List
20	24	Y-5R2H1U2024B	507
20	30	Y-5R2H1U2030B	535
20	36	Y-5R2H1U2036B	563
20	42	Y-5R2H1U2042B	589
20	48	Y-5R2H1U2048B	617
20	54	Y-5R2H1U2054B	645
20	60	Y-5R2H1U2060B	673
20	66	Y-5R2H1U2066B	699
20	72	Y-5R2H1U2072B	727
20	78	Y-5R2H1U2078B	755
20	84	Y-5R2H1U2084B	780
24	24	Y-5R2H1U2424B	531
24	30	Y-5R2H1U2430B	563
24	36	Y-5R2H1U2436B	594
24	42	Y-5R2H1U2442B	628
24	48	Y-5R2H1U2448B	661
24	54	Y-5R2H1U2454B	694
24	60	Y-5R2H1U2460B	727
24	66	Y-5R2H1U2466B	760
24	72	Y-5R2H1U2472B	793
24	78	Y-5R2H1U2478B	826
24	84	Y-5R2H1U2484B	859

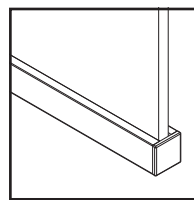
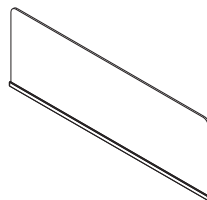

Surface Mount Channel

Specify

Notes

- Paint Selection (Grade C +10)
- Color Selection for PET - Lite Grey, Medium Grey, Tan or Vibrant Blue

- Offered in all AIS paint finishes.

PET Aloft Worksurface Width Front/Rear Surface Mount Channel Screens

Material	Where Used	Screen Type	Sized For	Mount Type
PET	Front/Rear on Worksurface	Channel	Aloft WS Width	Surface Mount

**PET ALOFT WORKSURFACE WIDTH
FRONT/REAR SURFACE MOUNT CHANNEL SCREENS**

H	W	Model Number	List
28	24	Y-5R2H1U2824B	551
28	30	Y-5R2H1U2830B	589
28	36	Y-5R2H1U2836B	627
28	42	Y-5R2H1U2842B	666
28	48	Y-5R2H1U2848B	705
28	54	Y-5R2H1U2854B	742
28	60	Y-5R2H1U2860B	779
28	66	Y-5R2H1U2866B	820
28	72	Y-5R2H1U2872B	858
28	78	Y-5R2H1U2878B	897
28	84	Y-5R2H1U2884B	935
32	24	Y-5R2H1U3224B	574
32	30	Y-5R2H1U3230B	616
32	36	Y-5R2H1U3236B	659
32	42	Y-5R2H1U3242B	705
32	48	Y-5R2H1U3248B	748
32	54	Y-5R2H1U3254B	791
32	60	Y-5R2H1U3260B	835
32	66	Y-5R2H1U3266B	877
32	72	Y-5R2H1U3272B	922
32	78	Y-5R2H1U3278B	966
32	84	Y-5R2H1U3284B	1,010

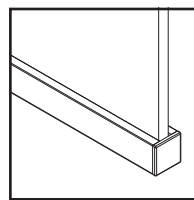
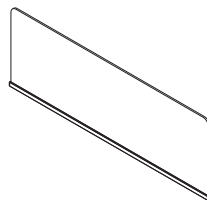

Surface Mount Channel

Specify

- Paint Selection (Grade C +10)
- Color Selection for PET - Lite Grey, Medium Grey, Tan or Vibrant Blue

Notes

- Offered in all AIS paint finishes.

Lexan Aloft Worksurface Width Front/Rear Under Surface Mount Channel Screens

Material	Where Used	Screen Type	Sized For	Mount Type
Lexan 1/4"	Front/Rear on Worksurface	Channel	Aloft WS Width	Under Surface Mount

LEXAN 1/4" ALOFT WORKSURFACE WIDTH FRONT/REAR UNDER SURFACE MOUNT CHANNEL SCREENS

H	W	Model Number	List
12	24	Y-1R2H2U1224B	735
12	30	Y-1R2H2U1230B	771
12	36	Y-1R2H2U1236B	808
12	42	Y-1R2H2U1242B	846
12	48	Y-1R2H2U1248B	885
12	54	Y-1R2H2U1254B	921
12	60	Y-1R2H2U1260B	958
12	66	Y-1R2H2U1266B	996
12	72	Y-1R2H2U1272B	1,032
12	78	Y-1R2H2U1278B	1,069
12	84	Y-1R2H2U1284B	1,105
16	24	Y-1R2H2U1624B	786
16	30	Y-1R2H2U1630B	834
16	36	Y-1R2H2U1636B	885
16	42	Y-1R2H2U1642B	935
16	48	Y-1R2H2U1648B	985
16	54	Y-1R2H2U1654B	1,032
16	60	Y-1R2H2U1660B	1,085
16	66	Y-1R2H2U1666B	1,132
16	72	Y-1R2H2U1672B	1,182
16	78	Y-1R2H2U1678B	1,233
16	84	Y-1R2H2U1684B	1,284

LEXAN 1/4" ALOFT WORKSURFACE WIDTH FRONT/REAR UNDER SURFACE MOUNT CHANNEL SCREENS

H	W	Model Number	List
20	24	Y-1R2H2U2024B	834
20	30	Y-1R2H2U2030B	897
20	36	Y-1R2H2U2036B	958
20	42	Y-1R2H2U2042B	1,021
20	48	Y-1R2H2U2048B	1,085
20	54	Y-1R2H2U2054B	1,146
20	60	Y-1R2H2U2060B	1,210
20	66	Y-1R2H2U2066B	1,272
20	72	Y-1R2H2U2072B	1,333
20	78	Y-1R2H2U2078B	1,396
20	84	Y-1R2H2U2084B	1,460

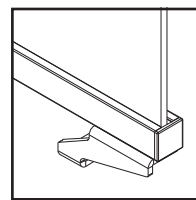
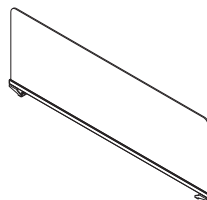

Under Surface Mount Channel

Specify

• Paint Selection (Grade C +10)

Notes

- Offered in all AIS paint finishes.
- Lexan available only in clear.

Glass Aloft Worksurface Width Front/Rear Under Surface Mount Channel Screens

Material	Where Used	Screen Type	Sized For	Mount Type
Glass 1/4"	Front/Rear on Worksurface	Channel	Aloft WS Width	Under Surface Mount

GLASS 1/4" ALOFT WORKSURFACE WIDTH FRONT/REAR UNDER SURFACE MOUNT CHANNEL SCREENS

H	W	Model Number	List	Tinted Glass	Frosted Glass
12	24	Y-3R2H2U1224B	665	+30	+110
12	30	Y-3R2H2U1230B	672	+38	+138
12	36	Y-3R2H2U1236B	680	+45	+165
12	42	Y-3R2H2U1242B	709	+53	+193
12	48	Y-3R2H2U1248B	737	+60	+220
12	54	Y-3R2H2U1254B	858	+68	+248
12	60	Y-3R2H2U1260B	796	+75	+275
12	66	Y-3R2H2U1266B	826	+83	+303
12	72	Y-3R2H2U1272B	854	+90	+330
12	78	Y-3R2H2U1278B	881	+98	+358
12	84	Y-3R2H2U1284B	910	+105	+385
16	24	Y-3R2H2U1624B	791	+40	+147
16	30	Y-3R2H2U1630B	816	+50	+184
16	36	Y-3R2H2U1636B	858	+60	+220
16	42	Y-3R2H2U1642B	886	+70	+257
16	48	Y-3R2H2U1648B	918	+80	+294
16	54	Y-3R2H2U1654B	970	+90	+330
16	60	Y-3R2H2U1660B	1,018	+100	+367
16	66	Y-3R2H2U1666B	1,029	+110	+404
16	72	Y-3R2H2U1672B	1,050	+120	+440
16	78	Y-3R2H2U1678B	1,066	+130	+477
16	84	Y-3R2H2U1684B	1,085	+140	+514

GLASS 1/4" ALOFT WORKSURFACE WIDTH FRONT/REAR UNDER SURFACE MOUNT CHANNEL SCREENS

H	W	Model Number	List	Tinted Glass	Frosted Glass
20	24	Y-3R2H2U2024B	736	+50	+184
20	30	Y-3R2H2U2030B	790	+63	+230
20	36	Y-3R2H2U2036B	826	+75	+275
20	42	Y-3R2H2U2042B	896	+88	+321
20	48	Y-3R2H2U2048B	947	+100	+367
20	54	Y-3R2H2U2054B	998	+113	+413
20	60	Y-3R2H2U2060B	1,052	+125	+459
20	66	Y-3R2H2U2066B	1,103	+138	+505
20	72	Y-3R2H2U2072B	1,158	+150	+550
20	78	Y-3R2H2U2078B	1,211	+163	+596
20	84	Y-3R2H2U2084B	1,263	+175	+642
24	24	Y-3R2H2U2424B	777	+60	+220
24	30	Y-3R2H2U2430B	840	+75	+275
24	36	Y-3R2H2U2436B	903	+90	+330
24	42	Y-3R2H2U2442B	964	+105	+385
24	48	Y-3R2H2U2448B	1,026	+120	+440
24	54	Y-3R2H2U2454B	1,089	+135	+495
24	60	Y-3R2H2U2460B	1,151	+150	+550
24	66	Y-3R2H2U2466B	1,213	+165	+605
24	72	Y-3R2H2U2472B	1,275	+180	+660
24	78	Y-3R2H2U2478B	1,334	+195	+715
24	84	Y-3R2H2U2484B	1,396	+210	+770

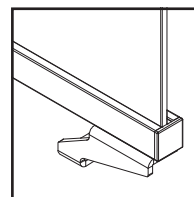
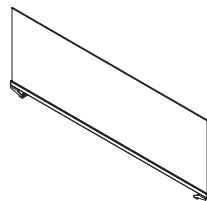

Under Surface Mount Channel

Specify

• Paint Selection (Grade C +10)

Notes

• Offered in all AIS paint finishes.

• Standard products for glass are always clear unless noted otherwise, other colors may be available upon special request (upcharges apply).

Glass Aloft Worksurface Width Front/Rear Under Surface Mount Channel Screens

Material	Where Used	Screen Type	Sized For	Mount Type
Glass 3/8"	Front/Rear on Worksurface	Channel	Aloft WS Width	Under Surface Mount

GLASS 3/8" ALOFT WORKSURFACE WIDTH FRONT/REAR UNDER SURFACE MOUNT CHANNEL SCREENS

H	W	Model Number	List	Tinted Glass	Frosted Glass
12	24	Y-4R2H2U1224B	847	+30	+60
12	30	Y-4R2H2U1230B	850	+38	+75
12	36	Y-4R2H2U1236B	914	+45	+90
12	42	Y-4R2H2U1242B	979	+53	+105
12	48	Y-4R2H2U1248B	1,045	+60	+120
12	54	Y-4R2H2U1254B	1,109	+68	+135
12	60	Y-4R2H2U1260B	1,173	+75	+150
12	66	Y-4R2H2U1266B	1,239	+83	+165
12	72	Y-4R2H2U1272B	1,304	+90	+180
12	78	Y-4R2H2U1278B	1,369	+98	+195
12	84	Y-4R2H2U1284B	1,434	+105	+210
16	24	Y-4R2H2U1624B	814	+40	+80
16	30	Y-4R2H2U1630B	895	+50	+100
16	36	Y-4R2H2U1636B	931	+60	+120
16	42	Y-4R2H2U1642B	1,022	+70	+140
16	48	Y-4R2H2U1648B	1,118	+80	+160
16	54	Y-4R2H2U1654B	1,184	+90	+180
16	60	Y-4R2H2U1660B	1,217	+100	+200
16	66	Y-4R2H2U1666B	1,315	+110	+220
16	72	Y-4R2H2U1672B	1,388	+120	+240
16	78	Y-4R2H2U1678B	1,541	+130	+260
16	84	Y-4R2H2U1684B	1,705	+140	+280

GLASS 3/8" ALOFT WORKSURFACE WIDTH FRONT/REAR UNDER SURFACE MOUNT CHANNEL SCREENS

H	W	Model Number	List	Tinted Glass	Frosted Glass
20	24	Y-4R2H2U2024B	911	+50	+100
20	30	Y-4R2H2U2030B	1,015	+63	+125
20	36	Y-4R2H2U2036B	1,113	+75	+150
20	42	Y-4R2H2U2042B	1,214	+88	+175
20	48	Y-4R2H2U2048B	1,315	+100	+200
20	54	Y-4R2H2U2054B	1,417	+113	+225
20	60	Y-4R2H2U2060B	1,516	+125	+250
20	66	Y-4R2H2U2066B	1,617	+138	+275
20	72	Y-4R2H2U2072B	1,718	+150	+300
20	78	Y-4R2H2U2078B	1,817	+163	+325
20	84	Y-4R2H2U2084B	1,917	+175	+350
24	24	Y-4R2H2U2424B	985	+60	+120
24	30	Y-4R2H2U2430B	1,103	+75	+150
24	36	Y-4R2H2U2436B	1,223	+90	+180
24	42	Y-4R2H2U2442B	1,343	+105	+210
24	48	Y-4R2H2U2448B	1,462	+120	+240
24	54	Y-4R2H2U2454B	1,581	+135	+270
24	60	Y-4R2H2U2460B	1,700	+150	+300
24	66	Y-4R2H2U2466B	1,818	+165	+330
24	72	Y-4R2H2U2472B	1,938	+180	+360
24	78	Y-4R2H2U2478B	2,056	+195	+390
24	84	Y-4R2H2U2484B	2,175	+210	+420

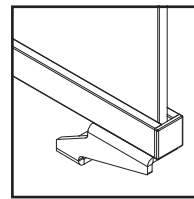
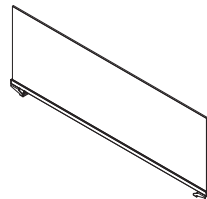

Under Surface Mount Channel

Specify

- Paint Selection (Grade C +10)

Notes

- Offered in all AIS paint finishes.
- Standard products for glass are always clear unless noted otherwise, other colors may be available upon special request (upcharges apply).

PET Aloft Worksurface Width Front/Rear Under Surface Mount Channel Screens

Material	Where Used	Screen Type	Sized For	Mount Type
PET	Front/Rear on Worksurface	Channel	Aloft WS Width	Under Surface Mount

PET ALOFT WORKSURFACE WIDTH FRONT/REAR UNDER SURFACE MOUNT CHANNEL SCREENS

H	W	Model Number	List
12	24	Y-5R2H2U1224B	593
12	30	Y-5R2H2U1230B	610
12	36	Y-5R2H2U1236B	627
12	42	Y-5R2H2U1242B	643
12	48	Y-5R2H2U1248B	659
12	54	Y-5R2H2U1254B	677
12	60	Y-5R2H2U1260B	693
12	66	Y-5R2H2U1266B	709
12	72	Y-5R2H2U1272B	725
12	78	Y-5R2H2U1278B	740
12	84	Y-5R2H2U1284B	758
16	24	Y-5R2H2U1624B	615
16	30	Y-5R2H2U1630B	638
16	36	Y-5R2H2U1636B	659
16	42	Y-5R2H2U1642B	682
16	48	Y-5R2H2U1648B	704
16	54	Y-5R2H2U1654B	725
16	60	Y-5R2H2U1660B	747
16	66	Y-5R2H2U1666B	768
16	72	Y-5R2H2U1672B	791
16	78	Y-5R2H2U1678B	813
16	84	Y-5R2H2U1684B	835

PET ALOFT WORKSURFACE WIDTH FRONT/REAR UNDER SURFACE MOUNT CHANNEL SCREENS

H	W	Model Number	List
20	24	Y-5R2H2U2024B	638
20	30	Y-5R2H2U2030B	665
20	36	Y-5R2H2U2036B	693
20	42	Y-5R2H2U2042B	720
20	48	Y-5R2H2U2048B	748
20	54	Y-5R2H2U2054B	775
20	60	Y-5R2H2U2060B	803
20	66	Y-5R2H2U2066B	830
20	72	Y-5R2H2U2072B	858
20	78	Y-5R2H2U2078B	885
20	84	Y-5R2H2U2084B	911
24	24	Y-5R2H2U2424B	659
24	30	Y-5R2H2U2430B	693
24	36	Y-5R2H2U2436B	725
24	42	Y-5R2H2U2442B	759
24	48	Y-5R2H2U2448B	791
24	54	Y-5R2H2U2454B	825
24	60	Y-5R2H2U2460B	858
24	66	Y-5R2H2U2466B	889
24	72	Y-5R2H2U2472B	922
24	78	Y-5R2H2U2478B	955
24	84	Y-5R2H2U2484B	989

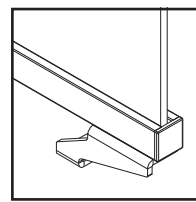
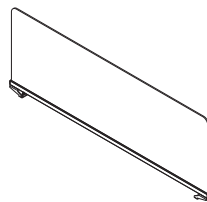

Under Surface Mount Channel

Specify

- Paint Selection (Grade C +10)
- Color Selection for PET - Lite Grey, Medium Grey, Tan or Vibrant Blue

Notes

- Offered in all AIS paint finishes.

PET Aloft Worksurface Width Front/Rear Under Surface Mount Channel Screens

Material	Where Used	Screen Type	Sized For	Mount Type
PET	Front/Rear on Worksurface	Channel	Aloft WS Width	Under Surface Mount

**PET ALOFT WORKSURFACE WIDTH
FRONT/REAR UNDER SURFACE MOUNT CHANNEL SCREENS**

H	W	Model Number	List
28	24	Y-5R2H2U2824B	682
28	30	Y-5R2H2U2830B	720
28	36	Y-5R2H2U2836B	758
28	42	Y-5R2H2U2842B	796
28	48	Y-5R2H2U2848B	835
28	54	Y-5R2H2U2854B	873
28	60	Y-5R2H2U2860B	910
28	66	Y-5R2H2U2866B	950
28	72	Y-5R2H2U2872B	988
28	78	Y-5R2H2U2878B	1,026
28	84	Y-5R2H2U2884B	1,063
32	24	Y-5R2H2U3224B	704
32	30	Y-5R2H2U3230B	747
32	36	Y-5R2H2U3236B	790
32	42	Y-5R2H2U3242B	835
32	48	Y-5R2H2U3248B	877
32	54	Y-5R2H2U3254B	921
32	60	Y-5R2H2U3260B	965
32	66	Y-5R2H2U3266B	1,008
32	72	Y-5R2H2U3272B	1,052
32	78	Y-5R2H2U3278B	1,097
32	84	Y-5R2H2U3284B	1,140

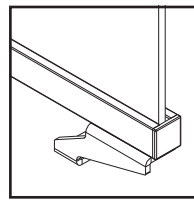
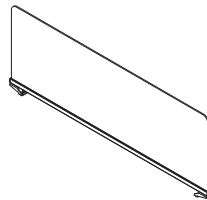

Under Surface Mount Channel

Specify

Notes

- Paint Selection (Grade C +10)
- Color Selection for PET - Lite Grey, Medium Grey, Tan or Vibrant Blue

- Offered in all AIS paint finishes.

Lexan Aloft Worksurface Width Front/Rear Surface Mount Clip Screens

Material	Where Used	Screen Type	Sized For	Mount Type
Lexan 1/4"	Front/Rear on Worksurface	Clip	Aloft WS Width	Surface Mount

LEXAN 1/4" ALOFT WORKSURFACE WIDTH FRONT/REAR SURFACE MOUNT CLIP SCREENS WITHOUT CUT-OUTS

H	W	Model Number	List
12	24	Y-1R3H1U1224B	605
12	30	Y-1R3H1U1230B	642
12	36	Y-1R3H1U1236B	679
12	42	Y-1R3H1U1242B	717
12	48	Y-1R3H1U1248B	755
12	54	Y-1R3H1U1254B	791
12	60	Y-1R3H1U1260B	829
12	66	Y-1R3H1U1266B	867
12	72	Y-1R3H1U1272B	903
12	78	Y-1R3H1U1278B	939
12	84	Y-1R3H1U1284B	976
16	24	Y-1R3H1U1624B	655
16	30	Y-1R3H1U1630B	704
16	36	Y-1R3H1U1636B	755
16	42	Y-1R3H1U1642B	804
16	48	Y-1R3H1U1648B	855
16	54	Y-1R3H1U1654B	903
16	60	Y-1R3H1U1660B	954
16	66	Y-1R3H1U1666B	1,002
16	72	Y-1R3H1U1672B	1,052
16	78	Y-1R3H1U1678B	1,102
16	84	Y-1R3H1U1684B	1,154

LEXAN 1/4" ALOFT WORKSURFACE WIDTH FRONT/REAR SURFACE MOUNT CLIP SCREENS WITHOUT CUT-OUTS

H	W	Model Number	List
20	24	Y-1R3H1U2024B	704
20	30	Y-1R3H1U2030B	766
20	36	Y-1R3H1U2036B	829
20	42	Y-1R3H1U2042B	890
20	48	Y-1R3H1U2048B	954
20	54	Y-1R3H1U2054B	1,017
20	60	Y-1R3H1U2060B	1,080
20	66	Y-1R3H1U2066B	1,141
20	72	Y-1R3H1U2072B	1,204
20	78	Y-1R3H1U2078B	1,267
20	84	Y-1R3H1U2084B	1,329

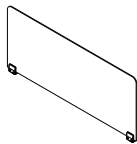

24 - 54 Wide

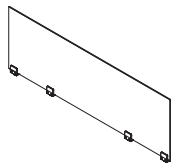

60 - 72 Wide

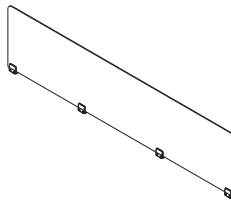

78 - 84 Wide

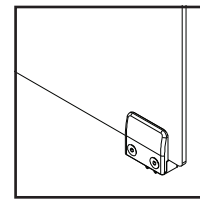

Surface Mount Clip

Specify

Notes

- Clips available in Metallic Silver only.
- Lexan available only in clear.

Lexan Aloft Worksurface Width Front/Rear Surface Mount Clip Screens

Material	Where Used	Screen Type	Sized For	Mount Type
Lexan 1/4"	Front/Rear on Worksurface	Clip	Aloft WS Width	Surface Mount

LEXAN 1/4" ALOFT WORKSURFACE WIDTH FRONT/REAR SURFACE MOUNT CLIP SCREENS WITH CUT-OUTS

H	W	Model Number	List
12	24	Y-1R3H1U1224A	605
12	30	Y-1R3H1U1230A	642
12	36	Y-1R3H1U1236A	679
12	42	Y-1R3H1U1242A	717
12	48	Y-1R3H1U1248A	755
12	54	Y-1R3H1U1254A	791
12	60	Y-1R3H1U1260A	829
12	66	Y-1R3H1U1266A	867
12	72	Y-1R3H1U1272A	903
12	78	Y-1R3H1U1278A	939
12	84	Y-1R3H1U1284A	976
16	24	Y-1R3H1U1624A	655
16	30	Y-1R3H1U1630A	704
16	36	Y-1R3H1U1636A	755
16	42	Y-1R3H1U1642A	804
16	48	Y-1R3H1U1648A	855
16	54	Y-1R3H1U1654A	903
16	60	Y-1R3H1U1660A	954
16	66	Y-1R3H1U1666A	1,002
16	72	Y-1R3H1U1672A	1,052
16	78	Y-1R3H1U1678A	1,102
16	84	Y-1R3H1U1684A	1,154

LEXAN 1/4" ALOFT WORKSURFACE WIDTH FRONT/REAR SURFACE MOUNT CLIP SCREENS WITH CUT-OUTS

H	W	Model Number	List
20	24	Y-1R3H1U2024A	704
20	30	Y-1R3H1U2030A	766
20	36	Y-1R3H1U2036A	829
20	42	Y-1R3H1U2042A	890
20	48	Y-1R3H1U2048A	954
20	54	Y-1R3H1U2054A	1,017
20	60	Y-1R3H1U2060A	1,080
20	66	Y-1R3H1U2066A	1,141
20	72	Y-1R3H1U2072A	1,204
20	78	Y-1R3H1U2078A	1,267
20	84	Y-1R3H1U2084A	1,329

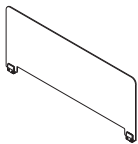

24 - 54 Wide

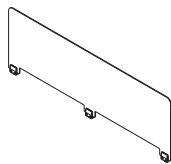

60 - 72 Wide

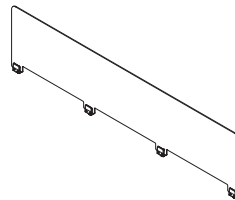

78 - 84 Wide

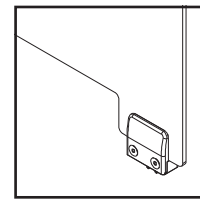

Surface Mount Clip

Specify

Notes

- Clips available in Metallic Silver only.
- Lexan available only in clear.

Glass Aloft Worksurface Width Front/Rear Surface Mount Clip Screens

Material	Where Used	Screen Type	Sized For	Mount Type
Glass 1/4"	Front/Rear on Worksurface	Clip	Aloft WS Width	Surface Mount

GLASS 1/4" ALOFT WORKSURFACE WIDTH FRONT/REAR SURFACE MOUNT CLIP SCREENS

H	W	Model Number	List	Tinted Glass	Frosted Glass
12	24	Y-3R3H1U1224B	535	+30	+110
12	30	Y-3R3H1U1230B	542	+38	+138
12	36	Y-3R3H1U1236B	549	+45	+165
12	42	Y-3R3H1U1242B	578	+53	+193
12	48	Y-3R3H1U1248B	607	+60	+220
12	54	Y-3R3H1U1254B	727	+68	+248
12	60	Y-3R3H1U1260B	666	+75	+275
12	66	Y-3R3H1U1266B	695	+83	+303
12	72	Y-3R3H1U1272B	724	+90	+330
12	78	Y-3R3H1U1278B	753	+98	+358
12	84	Y-3R3H1U1284B	779	+105	+385
16	24	Y-3R3H1U1624B	661	+40	+147
16	30	Y-3R3H1U1630B	687	+50	+184
16	36	Y-3R3H1U1636B	727	+60	+220
16	42	Y-3R3H1U1642B	756	+70	+257
16	48	Y-3R3H1U1648B	789	+80	+294
16	54	Y-3R3H1U1654B	840	+90	+330
16	60	Y-3R3H1U1660B	887	+100	+367
16	66	Y-3R3H1U1666B	899	+110	+404
16	72	Y-3R3H1U1672B	920	+120	+440
16	78	Y-3R3H1U1678B	937	+130	+477
16	84	Y-3R3H1U1684B	954	+140	+514

GLASS 1/4" ALOFT WORKSURFACE WIDTH FRONT/REAR SURFACE MOUNT CLIP SCREENS

H	W	Model Number	List	Tinted Glass	Frosted Glass
20	24	Y-3R3H1U2024B	606	+50	+184
20	30	Y-3R3H1U2030B	659	+63	+230
20	36	Y-3R3H1U2036B	695	+75	+275
20	42	Y-3R3H1U2042B	765	+88	+321
20	48	Y-3R3H1U2048B	816	+100	+367
20	54	Y-3R3H1U2054B	869	+113	+413
20	60	Y-3R3H1U2060B	922	+125	+459
20	66	Y-3R3H1U2066B	975	+138	+505
20	72	Y-3R3H1U2072B	1,028	+150	+550
20	78	Y-3R3H1U2078B	1,082	+163	+596
20	84	Y-3R3H1U2084B	1,133	+175	+642
24	24	Y-3R3H1U2424B	647	+60	+220
24	30	Y-3R3H1U2430B	710	+75	+275
24	36	Y-3R3H1U2436B	773	+90	+330
24	42	Y-3R3H1U2442B	834	+105	+385
24	48	Y-3R3H1U2448B	897	+120	+440
24	54	Y-3R3H1U2454B	958	+135	+495
24	60	Y-3R3H1U2460B	1,021	+150	+550
24	66	Y-3R3H1U2466B	1,085	+165	+605
24	72	Y-3R3H1U2472B	1,145	+180	+660
24	78	Y-3R3H1U2478B	1,206	+195	+715
24	84	Y-3R3H1U2484B	1,267	+210	+770

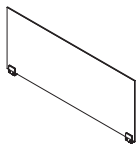

24 - 54 Wide

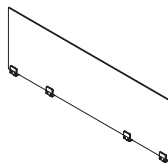

60 - 72 Wide

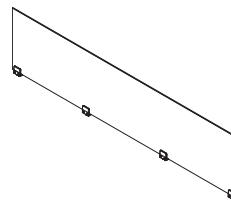

78 - 84 Wide

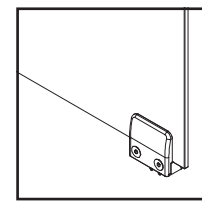

Surface Mount Clip

Specify

Notes

- Clips available in Metallic Silver only.
- Standard products for glass are always clear unless noted otherwise, other colors may be available upon special request (upcharges apply).

Glass Aloft Worksurface Width Front/Rear Surface Mount Clip Screens

Material	Where Used	Screen Type	Sized For	Mount Type
Glass 3/8"	Front/Rear on Worksurface	Clip	Aloft WS Width	Surface Mount

GLASS 3/8" ALOFT WORKSURFACE WIDTH FRONT/REAR SURFACE MOUNT CLIP SCREENS

H	W	Model Number	List	Tinted Glass	Frosted Glass
12	24	Y-4R3H1U1224B	718	+30	+60
12	30	Y-4R3H1U1230B	722	+38	+75
12	36	Y-4R3H1U1236B	786	+45	+90
12	42	Y-4R3H1U1242B	848	+53	+105
12	48	Y-4R3H1U1248B	914	+60	+120
12	54	Y-4R3H1U1254B	979	+68	+135
12	60	Y-4R3H1U1260B	1,045	+75	+150
12	66	Y-4R3H1U1266B	1,109	+83	+165
12	72	Y-4R3H1U1272B	1,173	+90	+180
12	78	Y-4R3H1U1278B	1,239	+98	+195
12	84	Y-4R3H1U1284B	1,304	+105	+210
16	24	Y-4R3H1U1624B	684	+40	+80
16	30	Y-4R3H1U1630B	764	+50	+100
16	36	Y-4R3H1U1636B	801	+60	+120
16	42	Y-4R3H1U1642B	891	+70	+140
16	48	Y-4R3H1U1648B	988	+80	+160
16	54	Y-4R3H1U1654B	1,056	+90	+180
16	60	Y-4R3H1U1660B	1,087	+100	+200
16	66	Y-4R3H1U1666B	1,184	+110	+220
16	72	Y-4R3H1U1672B	1,258	+120	+240
16	78	Y-4R3H1U1678B	1,280	+130	+260
16	84	Y-4R3H1U1684B	1,344	+140	+280

GLASS 3/8" ALOFT WORKSURFACE WIDTH FRONT/REAR SURFACE MOUNT CLIP SCREENS

H	W	Model Number	List	Tinted Glass	Frosted Glass
20	24	Y-4R3H1U2024B	780	+50	+100
20	30	Y-4R3H1U2030B	884	+63	+125
20	36	Y-4R3H1U2036B	984	+75	+150
20	42	Y-4R3H1U2042B	1,086	+88	+175
20	48	Y-4R3H1U2048B	1,184	+100	+200
20	54	Y-4R3H1U2054B	1,287	+113	+225
20	60	Y-4R3H1U2060B	1,387	+125	+250
20	66	Y-4R3H1U2066B	1,489	+138	+275
20	72	Y-4R3H1U2072B	1,587	+150	+300
20	78	Y-4R3H1U2078B	1,687	+163	+325
20	84	Y-4R3H1U2084B	1,788	+175	+350
24	24	Y-4R3H1U2424B	855	+60	+120
24	30	Y-4R3H1U2430B	975	+75	+150
24	36	Y-4R3H1U2436B	1,093	+90	+180
24	42	Y-4R3H1U2442B	1,212	+105	+210
24	48	Y-4R3H1U2448B	1,331	+120	+240
24	54	Y-4R3H1U2454B	1,450	+135	+270
24	60	Y-4R3H1U2460B	1,571	+150	+300
24	66	Y-4R3H1U2466B	1,690	+165	+330
24	72	Y-4R3H1U2472B	1,807	+180	+360
24	78	Y-4R3H1U2478B	1,925	+195	+390
24	84	Y-4R3H1U2484B	2,044	+210	+420

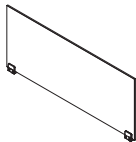

24 - 54 Wide

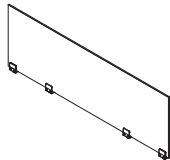

60 - 72 Wide

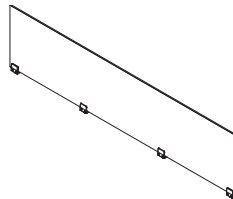

78 - 84 Wide

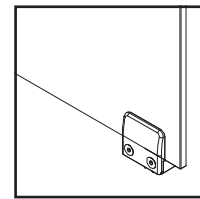

Surface Mount Clip

Specify

Notes

- Clips available in Metallic Silver only.
- Standard products for glass are always clear unless noted otherwise, other colors may be available upon special request (upcharges apply).

Lexan Aloft Worksurface Width Front/Rear Under Surface Mount Clip Screens

Material	Where Used	Screen Type	Sized For	Mount Type
Lexan 1/4"	Front/Rear on Worksurface	Clip	Aloft WS Width	Under Surface Mount

LEXAN 1/4" ALOFT WORKSURFACE WIDTH FRONT/REAR UNDER SURFACE MOUNT CLIP SCREENS WITHOUT CUT-OUTS

H	W	Model Number	List
12	24	Y-1R3H2U1224B	605
12	30	Y-1R3H2U1230B	642
12	36	Y-1R3H2U1236B	679
12	42	Y-1R3H2U1242B	717
12	48	Y-1R3H2U1248B	755
12	54	Y-1R3H2U1254B	791
12	60	Y-1R3H2U1260B	829
12	66	Y-1R3H2U1266B	867
12	72	Y-1R3H2U1272B	903
12	78	Y-1R3H2U1278B	939
12	84	Y-1R3H2U1284B	976
16	24	Y-1R3H2U1624B	655
16	30	Y-1R3H2U1630B	704
16	36	Y-1R3H2U1636B	755
16	42	Y-1R3H2U1642B	804
16	48	Y-1R3H2U1648B	855
16	54	Y-1R3H2U1654B	903
16	60	Y-1R3H2U1660B	954
16	66	Y-1R3H2U1666B	1,002
16	72	Y-1R3H2U1672B	1,052
16	78	Y-1R3H2U1678B	1,102
16	84	Y-1R3H2U1684B	1,154

LEXAN 1/4" ALOFT WORKSURFACE WIDTH FRONT/REAR UNDER SURFACE MOUNT CLIP SCREENS WITHOUT CUT-OUTS

H	W	Model Number	List
20	24	Y-1R3H2U2024B	704
20	30	Y-1R3H2U2030B	766
20	36	Y-1R3H2U2036B	829
20	42	Y-1R3H2U2042B	890
20	48	Y-1R3H2U2048B	954
20	54	Y-1R3H2U2054B	1,017
20	60	Y-1R3H2U2060B	1,080
20	66	Y-1R3H2U2066B	1,141
20	72	Y-1R3H2U2072B	1,204
20	78	Y-1R3H2U2078B	1,267
20	84	Y-1R3H2U2084B	1,329

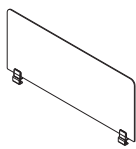

24 - 54 Wide

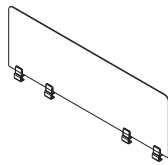

60 - 72 Wide

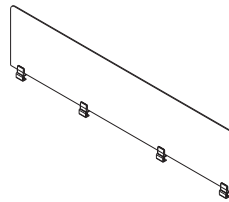

78 - 84 Wide

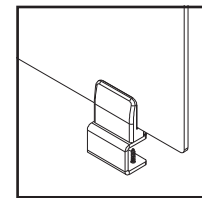

Under Surface Mount Clip

Specify

Notes

- Clips available in Metallic Silver only.
- Lexan available only in clear.

Lexan Aloft Worksurface Width Front/Rear Under Surface Mount Clip Screens

Material	Where Used	Screen Type	Sized For	Mount Type
Lexan 1/4"	Front/Rear on Worksurface	Clip	Aloft WS Width	Under Surface Mount

**LEXAN 1/4" ALOFT WORKSURFACE WIDTH
FRONT/REAR UNDER SURFACE MOUNT
CLIP SCREENS WITH CUT-OUTS**

H	W	Model Number	List
12	24	Y-1R3H2U1224A	605
12	30	Y-1R3H2U1230A	642
12	36	Y-1R3H2U1236A	679
12	42	Y-1R3H2U1242A	717
12	48	Y-1R3H2U1248A	755
12	54	Y-1R3H2U1254A	791
12	60	Y-1R3H2U1260A	829
12	66	Y-1R3H2U1266A	867
12	72	Y-1R3H2U1272A	903
12	78	Y-1R3H2U1278A	939
12	84	Y-1R3H2U1284A	976
16	24	Y-1R3H2U1624A	655
16	30	Y-1R3H2U1630A	704
16	36	Y-1R3H2U1636A	755
16	42	Y-1R3H2U1642A	804
16	48	Y-1R3H2U1648A	855
16	54	Y-1R3H2U1654A	903
16	60	Y-1R3H2U1660A	954
16	66	Y-1R3H2U1666A	1,002
16	72	Y-1R3H2U1672A	1,052
16	78	Y-1R3H2U1678A	1,102
16	84	Y-1R3H2U1684A	1,154

**LEXAN 1/4" ALOFT WORKSURFACE WIDTH
FRONT/REAR UNDER SURFACE MOUNT
CLIP SCREENS WITH CUT-OUTS**

H	W	Model Number	List
20	24	Y-1R3H2U2024A	704
20	30	Y-1R3H2U2030A	766
20	36	Y-1R3H2U2036A	829
20	42	Y-1R3H2U2042A	890
20	48	Y-1R3H2U2048A	954
20	54	Y-1R3H2U2054A	1,017
20	60	Y-1R3H2U2060A	1,080
20	66	Y-1R3H2U2066A	1,141
20	72	Y-1R3H2U2072A	1,204
20	78	Y-1R3H2U2078A	1,267
20	84	Y-1R3H2U2084A	1,329

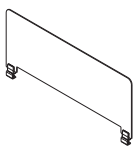

24 - 54 Wide

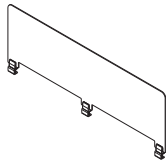

60 - 72 Wide

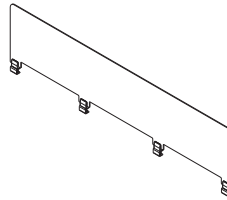

78 - 84 Wide

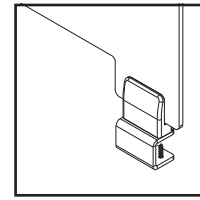

Under Surface Mount Clip

Specify

Notes

- Clips available in Metallic Silver only.
- Lexan available only in clear.

Glass Aloft Worksurface Width Front/Rear Under Surface Mount Clip Screens

Material	Where Used	Screen Type	Sized For	Mount Type
Glass 1/4"	Front/Rear on Worksurface	Clip	Aloft WS Width	Under Surface Mount

GLASS 1/4" ALOFT WORKSURFACE WIDTH FRONT/REAR UNDER SURFACE MOUNT CLIP SCREENS

H	W	Model Number	List	Tinted Glass	Frosted Glass
12	24	Y-3R3H2U1224B	535	+30	+110
12	30	Y-3R3H2U1230B	542	+38	+138
12	36	Y-3R3H2U1236B	549	+45	+165
12	42	Y-3R3H2U1242B	578	+53	+193
12	48	Y-3R3H2U1248B	607	+60	+220
12	54	Y-3R3H2U1254B	727	+68	+248
12	60	Y-3R3H2U1260B	666	+75	+275
12	66	Y-3R3H2U1266B	695	+83	+303
12	72	Y-3R3H2U1272B	724	+90	+330
12	78	Y-3R3H2U1278B	753	+98	+358
12	84	Y-3R3H2U1284B	779	+105	+385
16	24	Y-3R3H2U1624B	661	+40	+147
16	30	Y-3R3H2U1630B	687	+50	+184
16	36	Y-3R3H2U1636B	727	+60	+220
16	42	Y-3R3H2U1642B	756	+70	+257
16	48	Y-3R3H2U1648B	789	+80	+294
16	54	Y-3R3H2U1654B	840	+90	+330
16	60	Y-3R3H2U1660B	887	+100	+367
16	66	Y-3R3H2U1666B	899	+110	+404
16	72	Y-3R3H2U1672B	920	+120	+440
16	78	Y-3R3H2U1678B	937	+130	+477
16	84	Y-3R3H2U1684B	954	+140	+514

GLASS 1/4" ALOFT WORKSURFACE WIDTH FRONT/REAR UNDER SURFACE MOUNT CLIP SCREENS

H	W	Model Number	List	Tinted Glass	Frosted Glass
20	24	Y-3R3H2U2024B	606	+50	+184
20	30	Y-3R3H2U2030B	659	+63	+230
20	36	Y-3R3H2U2036B	695	+75	+275
20	42	Y-3R3H2U2042B	765	+88	+321
20	48	Y-3R3H2U2048B	816	+100	+367
20	54	Y-3R3H2U2054B	869	+113	+413
20	60	Y-3R3H2U2060B	922	+125	+459
20	66	Y-3R3H2U2066B	975	+138	+505
20	72	Y-3R3H2U2072B	1,028	+150	+550
20	78	Y-3R3H2U2078B	1,082	+163	+596
20	84	Y-3R3H2U2084B	1,133	+175	+642
24	24	Y-3R3H2U2424B	647	+60	+220
24	30	Y-3R3H2U2430B	710	+75	+275
24	36	Y-3R3H2U2436B	773	+90	+330
24	42	Y-3R3H2U2442B	834	+105	+385
24	48	Y-3R3H2U2448B	897	+120	+440
24	54	Y-3R3H2U2454B	958	+135	+495
24	60	Y-3R3H2U2460B	1,021	+150	+550
24	66	Y-3R3H2U2466B	1,085	+165	+605
24	72	Y-3R3H2U2472B	1,145	+180	+660
24	78	Y-3R3H2U2478B	1,206	+195	+715
24	84	Y-3R3H2U2484B	1,267	+210	+770

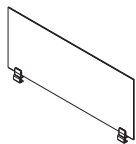

24 - 54 Wide

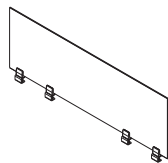

60 - 72 Wide

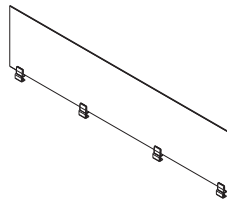

78 - 84 Wide

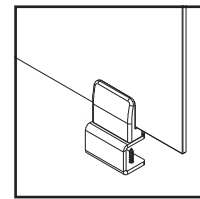

Under Surface Mount Clip

Specify

Notes

- Clips available in Metallic Silver only.
- Standard products for glass are always clear unless noted otherwise, other colors may be available upon special request (upcharges apply).

Lexan Aloft Worksurface Width Front/Rear Under Surface Mount Clip Screens

Material	Where Used	Screen Type	Sized For	Mount Type
Glass 3/8"	Front/Rear on Worksurface	Clip	Aloft WS Width	Under Surface Mount

GLASS 3/8" ALOFT WORKSURFACE WIDTH FRONT/REAR UNDER SURFACE MOUNT CLIP SCREENS

H	W	Model Number	List	Tinted Glass	Frosted Glass
12	24	Y-4R3H2U1224B	718	+30	+60
12	30	Y-4R3H2U1230B	722	+38	+75
12	36	Y-4R3H2U1236B	786	+45	+90
12	42	Y-4R3H2U1242B	848	+53	+105
12	48	Y-4R3H2U1248B	914	+60	+120
12	54	Y-4R3H2U1254B	979	+68	+135
12	60	Y-4R3H2U1260B	1,045	+75	+150
12	66	Y-4R3H2U1266B	1,109	+83	+165
12	72	Y-4R3H2U1272B	1,173	+90	+180
12	78	Y-4R3H2U1278B	1,239	+98	+195
12	84	Y-4R3H2U1284B	1,304	+105	+210
16	24	Y-4R3H2U1624B	684	+40	+80
16	30	Y-4R3H2U1630B	764	+50	+100
16	36	Y-4R3H2U1636B	801	+60	+120
16	42	Y-4R3H2U1642B	891	+70	+140
16	48	Y-4R3H2U1648B	988	+80	+160
16	54	Y-4R3H2U1654B	1,056	+90	+180
16	60	Y-4R3H2U1660B	1,087	+100	+200
16	66	Y-4R3H2U1666B	1,184	+110	+220
16	72	Y-4R3H2U1672B	1,258	+120	+240
16	78	Y-4R3H2U1678B	1,410	-	-
16	84	Y-4R3H2U1684B	1,474	-	-

GLASS 3/8" ALOFT WORKSURFACE WIDTH FRONT/REAR UNDER SURFACE MOUNT CLIP SCREENS

H	W	Model Number	List	Tinted Glass	Frosted Glass
20	24	Y-4R3H2U2024B	780	+50	+100
20	30	Y-4R3H2U2030B	884	+63	+125
20	36	Y-4R3H2U2036B	984	+75	+150
20	42	Y-4R3H2U2042B	1,086	+88	+175
20	48	Y-4R3H2U2048B	1,184	+100	+200
20	54	Y-4R3H2U2054B	1,287	+113	+225
20	60	Y-4R3H2U2060B	1,387	+125	+250
20	66	Y-4R3H2U2066B	1,489	+138	+275
20	72	Y-4R3H2U2072B	1,587	+150	+300
20	78	Y-4R3H2U2078B	1,687	+163	+325
20	84	Y-4R3H2U2084B	1,788	+175	+350
24	24	Y-4R3H2U2424B	855	+60	+120
24	30	Y-4R3H2U2430B	975	+75	+150
24	36	Y-4R3H2U2436B	1,093	+90	+180
24	42	Y-4R3H2U2442B	1,212	+105	+210
24	48	Y-4R3H2U2448B	1,331	+120	+240
24	54	Y-4R3H2U2454B	1,450	+135	+270
24	60	Y-4R3H2U2460B	1,571	+150	+300
24	66	Y-4R3H2U2466B	1,690	+165	+330
24	72	Y-4R3H2U2472B	1,807	+180	+360
24	78	Y-4R3H2U2478B	1,925	+195	+390
24	84	Y-4R3H2U2484B	2,044	+210	+420

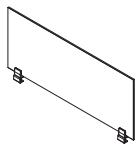

24 - 54 Wide

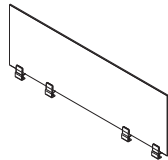

60 - 72 Wide

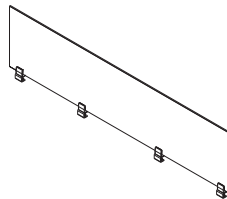

78 - 84 Wide

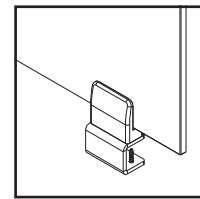

Under Surface Mount Clip

Specify

Notes

- Clips available in Metallic Silver only.
- Standard products for glass are always clear unless noted otherwise, other colors may be available upon special request (upcharges apply).

Lexan Aloft Worksurface Width Front/Rear Freestanding Clip Screens

Material	Where Used	Screen Type	Sized For	Mount Type
Lexan 1/4"	Front/Rear on Worksurface	Clip	Aloft WS Width	Freestanding

LEXAN 1/4" ALOFT WORKSURFACE WIDTH FRONT/REAR FREESTANDING CLIP SCREENS WITHOUT CUT-OUTS

H	W	Model Number	List
12	24	Y-1R3H4U1224B	735
12	30	Y-1R3H4U1230B	771
12	36	Y-1R3H4U1236B	808
12	42	Y-1R3H4U1242B	846
12	48	Y-1R3H4U1248B	885
12	54	Y-1R3H4U1254B	921
12	60	Y-1R3H4U1260B	1,024
12	66	Y-1R3H4U1266B	1,061
12	72	Y-1R3H4U1272B	1,098
12	78	Y-1R3H4U1278B	1,199
12	84	Y-1R3H4U1284B	1,236
16	24	Y-1R3H4U1624B	786
16	30	Y-1R3H4U1630B	834
16	36	Y-1R3H4U1636B	885
16	42	Y-1R3H4U1642B	935
16	48	Y-1R3H4U1648B	985
16	54	Y-1R3H4U1654B	1,032
16	60	Y-1R3H4U1660B	1,149
16	66	Y-1R3H4U1666B	1,198
16	72	Y-1R3H4U1672B	1,248
16	78	Y-1R3H4U1678B	1,362
16	84	Y-1R3H4U1684B	1,414

LEXAN 1/4" ALOFT WORKSURFACE WIDTH FRONT/REAR FREESTANDING CLIP SCREENS WITHOUT CUT-OUTS

H	W	Model Number	List
20	24	Y-1R3H4U2024B	834
20	30	Y-1R3H4U2030B	897
20	36	Y-1R3H4U2036B	958
20	42	Y-1R3H4U2042B	1,021
20	48	Y-1R3H4U2048B	1,085
20	54	Y-1R3H4U2054B	1,146
20	60	Y-1R3H4U2060B	1,275
20	66	Y-1R3H4U2066B	1,335
20	72	Y-1R3H4U2072B	1,399
20	78	Y-1R3H4U2078B	1,527
20	84	Y-1R3H4U2084B	1,589

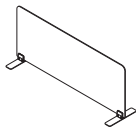

24 - 54 Wide

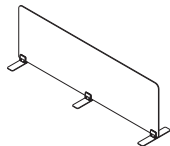

60 - 72 Wide

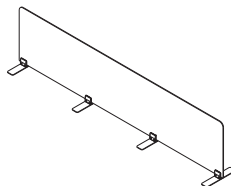

78 - 84 Wide

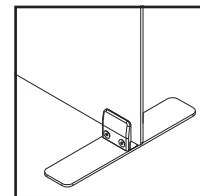

Freestanding Clip

Specify

Notes

- Clips available in Metallic Silver only.
- Lexan available only in clear.
- Non-marring feet measure 2 3/8" x 12".

Lexan Aloft Worksurface Width Front/Rear Freestanding Clip Screens

Material	Where Used	Screen Type	Sized For	Mount Type
Lexan 1/4"	Front/Rear on Worksurface	Clip	Aloft WS Width	Freestanding

LEXAN 1/4" ALOFT WORKSURFACE WIDTH FRONT/REAR FREESTANDING CLIP SCREENS WITH CUT-OUTS

H	W	Model Number	List
12	24	Y-1R3H4U1224A	735
12	30	Y-1R3H4U1230A	771
12	36	Y-1R3H4U1236A	808
12	42	Y-1R3H4U1242A	846
12	48	Y-1R3H4U1248A	885
12	54	Y-1R3H4U1254A	921
12	60	Y-1R3H4U1260A	1,024
12	66	Y-1R3H4U1266A	1,061
12	72	Y-1R3H4U1272A	1,098
12	78	Y-1R3H4U1278A	1,199
12	84	Y-1R3H4U1284A	1,236
16	24	Y-1R3H4U1624A	786
16	30	Y-1R3H4U1630A	834
16	36	Y-1R3H4U1636A	885
16	42	Y-1R3H4U1642A	935
16	48	Y-1R3H4U1648A	985
16	54	Y-1R3H4U1654A	1,032
16	60	Y-1R3H4U1660A	1,149
16	66	Y-1R3H4U1666A	1,198
16	72	Y-1R3H4U1672A	1,248
16	78	Y-1R3H4U1678A	1,362
16	84	Y-1R3H4U1684A	1,414

LEXAN 1/4" ALOFT WORKSURFACE WIDTH FRONT/REAR FREESTANDING CLIP SCREENS WITH CUT-OUTS

H	W	Model Number	List
20	24	Y-1R3H4U2024A	834
20	30	Y-1R3H4U2030A	897
20	36	Y-1R3H4U2036A	958
20	42	Y-1R3H4U2042A	1,021
20	48	Y-1R3H4U2048A	1,085
20	54	Y-1R3H4U2054A	1,146
20	60	Y-1R3H4U2060A	1,275
20	66	Y-1R3H4U2066A	1,335
20	72	Y-1R3H4U2072A	1,399
20	78	Y-1R3H4U2078A	1,527
20	84	Y-1R3H4U2084A	1,589

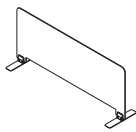

24 - 54 Wide

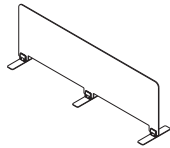

60 - 72 Wide

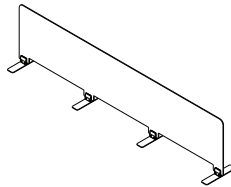

78 - 84 Wide

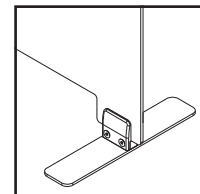

Freestanding Clip

Specify

Notes

- Clips available in Metallic Silver only.
- Lexan available only in clear.
- Non-marring feet measure 2 3/8" x 12".

PET Aloft Worksurface Width Front/Rear Surface Mount Lite Screens

Material	Where Used	Screen Type	Sized For	Mount Type
PET	Front/Rear on Worksurface	Lite	Aloft WS Width	Surface Mount

PET ALOFT WORKSURFACE WIDTH FRONT/REAR SURFACE MOUNT LITE SCREENS

H	W	Model Number	List
12	24	Y-5R4H1U1224B	494
12	30	Y-5R4H1U1230B	504
12	36	Y-5R4H1U1236B	512
12	42	Y-5R4H1U1242B	521
12	48	Y-5R4H1U1248B	533
12	54	Y-5R4H1U1254B	542
12	60	Y-5R4H1U1260B	549
12	66	Y-5R4H1U1266B	562
12	72	Y-5R4H1U1272B	571
12	78	Y-5R4H1U1278B	578
12	84	Y-5R4H1U1284B	589
16	24	Y-5R4H1U1624B	506
16	30	Y-5R4H1U1630B	518
16	36	Y-5R4H1U1636B	533
16	42	Y-5R4H1U1642B	544
16	48	Y-5R4H1U1648B	557
16	54	Y-5R4H1U1654B	571
16	60	Y-5R4H1U1660B	583
16	66	Y-5R4H1U1666B	596
16	72	Y-5R4H1U1672B	607
16	78	Y-5R4H1U1678B	619
16	84	Y-5R4H1U1684B	634

PET ALOFT WORKSURFACE WIDTH FRONT/REAR SURFACE MOUNT LITE SCREENS

H	W	Model Number	List
20	24	Y-5R4H1U2024B	518
20	30	Y-5R4H1U2030B	535
20	36	Y-5R4H1U2036B	549
20	42	Y-5R4H1U2042B	567
20	48	Y-5R4H1U2048B	583
20	54	Y-5R4H1U2054B	599
20	60	Y-5R4H1U2060B	614
20	66	Y-5R4H1U2066B	631
20	72	Y-5R4H1U2072B	646
20	78	Y-5R4H1U2078B	663
20	84	Y-5R4H1U2084B	678
24	24	Y-5R4H1U2424B	533
24	30	Y-5R4H1U2430B	549
24	36	Y-5R4H1U2436B	571
24	42	Y-5R4H1U2442B	589
24	48	Y-5R4H1U2448B	607
24	54	Y-5R4H1U2454B	627
24	60	Y-5R4H1U2460B	646
24	66	Y-5R4H1U2466B	666
24	72	Y-5R4H1U2472B	684
24	78	Y-5R4H1U2478B	704
24	84	Y-5R4H1U2484B	724

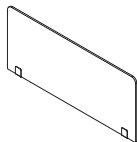

24 - 54 Wide

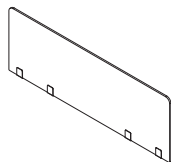

60 - 72 Wide

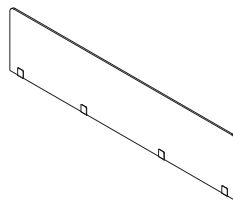

78 - 84 Wide

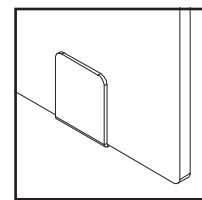

Surface Mount Lite

Specify

- Paint Selection (Grade C +10)
- Color Selection for PET - Lite Grey, Medium Grey, Tan or Vibrant Blue

Notes

- PET Territory Screens are designed to mount to AIS worksurfaces. Specify based on nominal size for the desired system. Order screens that correspond to worksurface width.
- PET screen inserts are 1/2" (12mm) thick.

PET Aloft Worksurface Width Front/Rear Surface Mount Lite Screens

Material	Where Used	Screen Type	Sized For	Mount Type
PET	Front/Rear on Worksurface	Lite	Aloft WS Width	Surface Mount

PET ALOFT WORKSURFACE WIDTH FRONT/REAR SURFACE MOUNT LITE SCREENS

H	W	Model Number	List
28	24	Y-5R4H1U2824B	544
28	30	Y-5R4H1U2830B	567
28	36	Y-5R4H1U2836B	589
28	42	Y-5R4H1U2842B	612
28	48	Y-5R4H1U2848B	634
28	54	Y-5R4H1U2854B	656
28	60	Y-5R4H1U2860B	678
28	66	Y-5R4H1U2866B	700
28	72	Y-5R4H1U2872B	724
28	78	Y-5R4H1U2878B	746
28	84	Y-5R4H1U2884B	767
32	24	Y-5R4H1U3224B	557
32	30	Y-5R4H1U3230B	583
32	36	Y-5R4H1U3236B	607
32	42	Y-5R4H1U3242B	634
32	48	Y-5R4H1U3248B	659
32	54	Y-5R4H1U3254B	684
32	60	Y-5R4H1U3260B	710
32	66	Y-5R4H1U3266B	736
32	72	Y-5R4H1U3272B	761
32	78	Y-5R4H1U3278B	788
32	84	Y-5R4H1U3284B	810

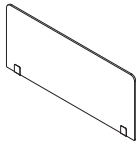

24 - 54 Wide

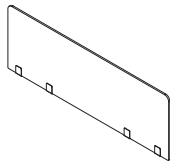

60 - 72 Wide

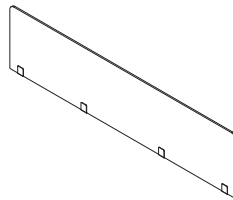

78 - 84 Wide

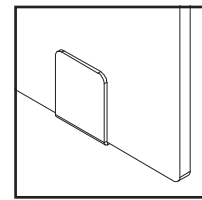

Surface Mount Lite

Specify

- Paint Selection (Grade C +10)
- Color Selection for PET - Lite Grey, Medium Grey, Tan or Vibrant Blue

Notes

- PET Territory Screens are designed to mount to AIS worksurfaces. Specify based on nominal size for the desired system. Order screens that correspond to worksurface width.
- PET screen inserts are 1/2" (12mm) thick.

PET Aloft Worksurface Width Front/Rear Under Surface Mount Lite Screens

Material	Where Used	Screen Type	Sized For	Mount Type
PET	Front/Rear on Worksurface	Lite	Aloft WS Width	Under Surface Mount

PET ALOFT WORKSURFACE WIDTH FRONT/REAR UNDER SURFACE MOUNT LITE SCREENS

H	W	Model Number	List
12	24	Y-5R4H2U1224B	494
12	30	Y-5R4H2U1230B	504
12	36	Y-5R4H2U1236B	512
12	42	Y-5R4H2U1242B	521
12	48	Y-5R4H2U1248B	533
12	54	Y-5R4H2U1254B	542
12	60	Y-5R4H2U1260B	549
12	66	Y-5R4H2U1266B	562
12	72	Y-5R4H2U1272B	571
12	78	Y-5R4H2U1278B	578
12	84	Y-5R4H2U1284B	589
16	24	Y-5R4H2U1624B	506
16	30	Y-5R4H2U1630B	518
16	36	Y-5R4H2U1636B	533
16	42	Y-5R4H2U1642B	544
16	48	Y-5R4H2U1648B	557
16	54	Y-5R4H2U1654B	571
16	60	Y-5R4H2U1660B	583
16	66	Y-5R4H2U1666B	596
16	72	Y-5R4H2U1672B	607
16	78	Y-5R4H2U1678B	619
16	84	Y-5R4H2U1684B	634

PET ALOFT WORKSURFACE WIDTH FRONT/REAR UNDER SURFACE MOUNT LITE SCREENS

H	W	Model Number	List
20	24	Y-5R4H2U2024B	518
20	30	Y-5R4H2U2030B	535
20	36	Y-5R4H2U2036B	549
20	42	Y-5R4H2U2042B	567
20	48	Y-5R4H2U2048B	583
20	54	Y-5R4H2U2054B	599
20	60	Y-5R4H2U2060B	614
20	66	Y-5R4H2U2066B	631
20	72	Y-5R4H2U2072B	646
20	78	Y-5R4H2U2078B	663
20	84	Y-5R4H2U2084B	678
24	24	Y-5R4H2U2424B	533
24	30	Y-5R4H2U2430B	549
24	36	Y-5R4H2U2436B	571
24	42	Y-5R4H2U2442B	589
24	48	Y-5R4H2U2448B	607
24	54	Y-5R4H2U2454B	627
24	60	Y-5R4H2U2460B	646
24	66	Y-5R4H2U2466B	666
24	72	Y-5R4H2U2472B	684
24	78	Y-5R4H2U2478B	704
24	84	Y-5R4H2U2484B	724

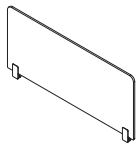

24 - 54 Wide

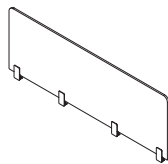

60 - 72 Wide

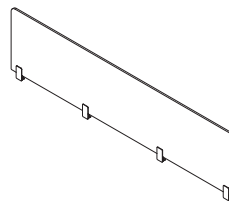

78 - 84 Wide

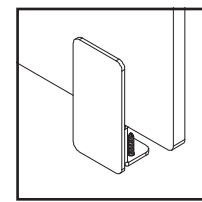

Under Surface Mount Lite

Specify

- Paint Selection (Grade C +10)
- Color Selection for PET - Lite Grey, Medium Grey, Tan or Vibrant Blue

Notes

- PET Territory Screens are designed to mount to AIS worksurfaces. Specify based on nominal size for the desired system. Order screens that correspond to worksurface width.
- PET screen inserts are 1/2" (12mm) thick.

PET Aloft Worksurface Width Front/Rear Under Surface Mount Lite Screens

Material	Where Used	Screen Type	Sized For	Mount Type
PET	Front/Rear on Worksurface	Lite	Aloft WS Width	Under Surface Mount

PET ALOFT WORKSURFACE WIDTH FRONT/REAR UNDER SURFACE MOUNT LITE SCREENS

H	W	Model Number	List
28	24	Y-5R4H2U2824B	544
28	30	Y-5R4H2U2830B	567
28	36	Y-5R4H2U2836B	589
28	42	Y-5R4H2U2842B	612
28	48	Y-5R4H2U2848B	634
28	54	Y-5R4H2U2854B	656
28	60	Y-5R4H2U2860B	678
28	66	Y-5R4H2U2866B	700
28	72	Y-5R4H2U2872B	724
28	78	Y-5R4H2U2878B	746
28	84	Y-5R4H2U2884B	767
32	24	Y-5R4H2U3224B	557
32	30	Y-5R4H2U3230B	583
32	36	Y-5R4H2U3236B	607
32	42	Y-5R4H2U3242B	634
32	48	Y-5R4H2U3248B	659
32	54	Y-5R4H2U3254B	684
32	60	Y-5R4H2U3260B	710
32	66	Y-5R4H2U3266B	736
32	72	Y-5R4H2U3272B	761
32	78	Y-5R4H2U3278B	788
32	84	Y-5R4H2U3284B	810

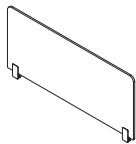

24 - 54 Wide

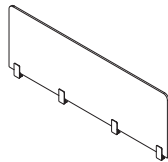

60 - 72 Wide

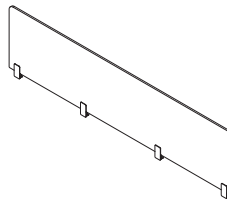

78 - 84 Wide

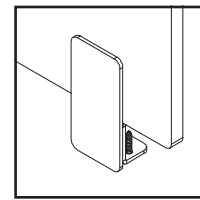

Under Surface Mount Lite

Specify

- Paint Selection (Grade C +10)
- Color Selection for PET - Lite Grey, Medium Grey, Tan or Vibrant Blue

Notes

- PET Territory Screens are designed to mount to AIS worksurfaces. Specify based on nominal size for the desired system. Order screens that correspond to worksurface width.
- PET screen inserts are 1/2" (12mm) thick.

PET Aloft Worksurface Width Front/Rear Freestanding Lite Screens

Material	Where Used	Screen Type	Sized For	Mount Type
PET	Front/Rear on Worksurface	Lite	Aloft WS Width	Freestanding

PET ALOFT WORKSURFACE WIDTH FRONT/REAR FREESTANDING LITE SCREENS

H	W	Model Number	List
12	24	Y-5R4H4U1224B	624
12	30	Y-5R4H4U1230B	634
12	36	Y-5R4H4U1236B	643
12	42	Y-5R4H4U1242B	652
12	48	Y-5R4H4U1248B	663
12	54	Y-5R4H4U1254B	672
12	60	Y-5R4H4U1260B	746
12	66	Y-5R4H4U1266B	756
12	72	Y-5R4H4U1272B	765
12	78	Y-5R4H4U1278B	839
12	84	Y-5R4H4U1284B	848
16	24	Y-5R4H4U1624B	637
16	30	Y-5R4H4U1630B	648
16	36	Y-5R4H4U1636B	663
16	42	Y-5R4H4U1642B	674
16	48	Y-5R4H4U1648B	687
16	54	Y-5R4H4U1654B	699
16	60	Y-5R4H4U1660B	777
16	66	Y-5R4H4U1666B	791
16	72	Y-5R4H4U1672B	803
16	78	Y-5R4H4U1678B	880
16	84	Y-5R4H4U1684B	895

PET ALOFT WORKSURFACE WIDTH FRONT/REAR FREESTANDING LITE SCREENS

H	W	Model Number	List
20	24	Y-5R4H4U2024B	648
20	30	Y-5R4H4U2030B	665
20	36	Y-5R4H4U2036B	680
20	42	Y-5R4H4U2042B	697
20	48	Y-5R4H4U2048B	713
20	54	Y-5R4H4U2054B	728
20	60	Y-5R4H4U2060B	808
20	66	Y-5R4H4U2066B	827
20	72	Y-5R4H4U2072B	841
20	78	Y-5R4H4U2078B	922
20	84	Y-5R4H4U2084B	938
24	24	Y-5R4H4U2424B	663
24	30	Y-5R4H4U2430B	680
24	36	Y-5R4H4U2436B	699
24	42	Y-5R4H4U2442B	720
24	48	Y-5R4H4U2448B	737
24	54	Y-5R4H4U2454B	758
24	60	Y-5R4H4U2460B	841
24	66	Y-5R4H4U2466B	861
24	72	Y-5R4H4U2472B	879
24	78	Y-5R4H4U2478B	964
24	84	Y-5R4H4U2484B	984

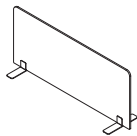

24 - 54 Wide

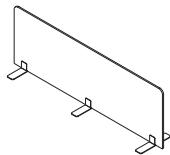

60 - 72 Wide

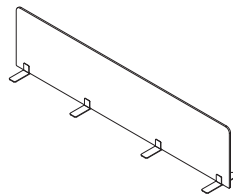

78 - 84 Wide

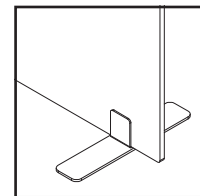

Freestanding Lite

Specify

- Paint Selection (Grade C +10)
- Color Selection for PET - Lite Grey, Medium Grey, Tan or Vibrant Blue

Notes

- PET Territory Screens are designed to mount to AIS worksurfaces. Specify based on nominal size for the desired system. Order screens that correspond to worksurface width.
- PET screen inserts are 1/2" (12mm) thick.
- Non-marring feet measure 2 3/8" x 12".

PET Aloft Worksurface Width Front/Rear Freestanding Lite Screens

Material	Where Used	Screen Type	Sized For	Mount Type
PET	Front/Rear on Worksurface	Lite	Aloft WS Width	Freestanding

PET ALOFT WORKSURFACE WIDTH FRONT/REAR FREESTANDING LITE SCREENS

H	W	Model Number	List
28	24	Y-5R4H4U2824B	674
28	30	Y-5R4H4U2830B	697
28	36	Y-5R4H4U2836B	720
28	42	Y-5R4H4U2842B	740
28	48	Y-5R4H4U2848B	764
28	54	Y-5R4H4U2854B	787
28	60	Y-5R4H4U2860B	873
28	66	Y-5R4H4U2866B	897
28	72	Y-5R4H4U2872B	918
28	78	Y-5R4H4U2878B	1,006
28	84	Y-5R4H4U2884B	1,028
32	24	Y-5R4H4U3224B	687
32	30	Y-5R4H4U3230B	713
32	36	Y-5R4H4U3236B	737
32	42	Y-5R4H4U3242B	764
32	48	Y-5R4H4U3248B	790
32	54	Y-5R4H4U3254B	814
32	60	Y-5R4H4U3260B	906
32	66	Y-5R4H4U3266B	931
32	72	Y-5R4H4U3272B	956
32	78	Y-5R4H4U3278B	1,048
32	84	Y-5R4H4U3284B	1,071

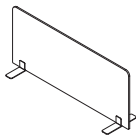

24 - 54 Wide

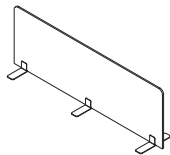

60 - 72 Wide

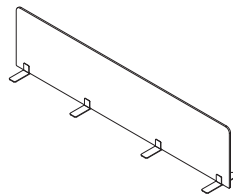

78 - 84 Wide

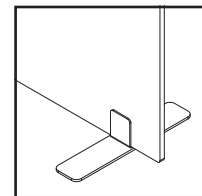

Freestanding Lite

Specify

- Paint Selection (Grade C +10)
- Color Selection for PET - Lite Grey, Medium Grey, Tan or Vibrant Blue

Notes

- PET Territory Screens are designed to mount to AIS worksurfaces. Specify based on nominal size for the desired system. Order screens that correspond to worksurface width.
- PET screen inserts are 1/2" (12mm) thick.
- Non-marring feet measure 2 3/8" x 12".

Aloft Worksurface Width Front/Rear Surface Mount Slimline Screens

Material	Where Used	Screen Type	Sized For	Mount Type
Fabric/Vinyl/Whiteboard/Laminate	Front/Rear on Worksurface	Slimline	Aloft WS Width	Surface Mount

ALOFT WORKSURFACE WIDTH FRONT/REAR SURFACE MOUNT SLIMLINE SCREENS

H	W	Model Number	List	Fabric Grade C	Fabric Grade D
12	36	Y-6R1H1U1236B	582	+7	+14
12	42	Y-6R1H1U1242B	613	+7	+14
12	48	Y-6R1H1U1248B	645	+7	+14
12	54	Y-6R1H1U1254B	678	+7	+14
12	60	Y-6R1H1U1260B	709	+7	+14
12	66	Y-6R1H1U1266B	920	+7	+14
12	72	Y-6R1H1U1272B	979	+7	+14
16	36	Y-6R1H1U1636B	650	+11	+22
16	42	Y-6R1H1U1642B	685	+11	+22
16	48	Y-6R1H1U1648B	722	+11	+22
16	54	Y-6R1H1U1654B	758	+11	+22
16	60	Y-6R1H1U1660B	793	+11	+22
16	66	Y-6R1H1U1666B	972	+11	+22
16	72	Y-6R1H1U1672B	1,032	+11	+22
20	36	Y-6R1H1U2036B	720	+15	+30
20	42	Y-6R1H1U2042B	759	+15	+30
20	48	Y-6R1H1U2048B	798	+15	+30
20	54	Y-6R1H1U2054B	835	+15	+30
20	60	Y-6R1H1U2060B	874	+15	+30
20	66	Y-6R1H1U2066B	1,022	+15	+30
20	72	Y-6R1H1U2072B	1,088	+15	+30

ALOFT WORKSURFACE WIDTH FRONT/REAR SURFACE MOUNT SLIMLINE SCREENS

H	W	Model Number	List	Fabric Grade C	Fabric Grade D
24	36	Y-6R1H1U2436B	789	+18	+36
24	42	Y-6R1H1U2442B	831	+18	+36
24	48	Y-6R1H1U2448B	874	+18	+36
24	54	Y-6R1H1U2454B	912	+18	+36
24	60	Y-6R1H1U2460B	956	+18	+36
24	66	Y-6R1H1U2466B	1,071	+18	+36
24	72	Y-6R1H1U2472B	1,141	+18	+36
28	36	Y-6R1H1U2836B	858	+21	+42
28	42	Y-6R1H1U2842B	904	+21	+42
28	48	Y-6R1H1U2848B	951	+21	+42
28	54	Y-6R1H1U2854B	991	+21	+42
28	60	Y-6R1H1U2860B	1,037	+21	+42
28	66	Y-6R1H1U2866B	1,122	+21	+42
28	72	Y-6R1H1U2872B	1,197	+21	+42

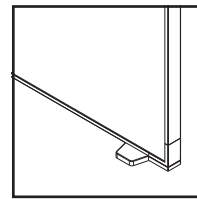
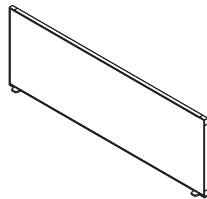

Surface Mount Slimline

Specify

- Paint Selection (Grade C +10)
- Fabric, Vinyl, Whiteboard or Laminate Selection

Notes

- Slimline screens may be fabric, vinyl, whiteboard or laminate on either side. Upcharges for Grade C and D are listed per side. Whiteboards are standard list and have no upcharge.
- Offered in all AIS paint finishes.

Aloft 120 HAT Width Front/Rear Surface Mount Slimline Screens

Material	Where Used	Screen Type	Sized For	Mount Type
Fabric/Vinyl/Whiteboard/Laminate	Front/Rear on Worksurface	Slimline	Aloft 120 HAT Width	Surface Mount

ALOFT 120 HAT WIDTH FRONT/REAR SURFACE MOUNT SLIMLINE SCREENS

H	W	Model Number	List	Fabric Grade C	Fabric Grade D
12	36	B-SSH120-1236	582	+7	+14
12	42	B-SSH120-1242	613	+7	+14
12	48	B-SSH120-1248	645	+7	+14
12	54	B-SSH120-1254	678	+7	+14
12	60	B-SSH120-1260	709	+7	+14
16	36	B-SSH120-1636	650	+11	+22
16	42	B-SSH120-1642	685	+11	+22
16	48	B-SSH120-1648	722	+11	+22
16	54	B-SSH120-1654	758	+11	+22
16	60	B-SSH120-1660	793	+11	+22
20	36	B-SSH120-2036	720	+15	+30
20	42	B-SSH120-2042	759	+15	+30
20	48	B-SSH120-2048	798	+15	+30
20	54	B-SSH120-2054	835	+15	+30
20	60	B-SSH120-2060	874	+15	+30

ALOFT 120 HAT WIDTH FRONT/REAR SURFACE MOUNT SLIMLINE SCREENS

H	W	Model Number	List	Fabric Grade C	Fabric Grade D
24	36	B-SSH120-2436	761	+19	+38
24	42	B-SSH120-2442	803	+19	+38
24	48	B-SSH120-2448	844	+19	+38
24	54	B-SSH120-2454	881	+19	+38
24	60	B-SSH120-2460	924	+19	+38
28	36	B-SSH120-2836	828	+23	+50
28	42	B-SSH120-2842	873	+23	+50
28	48	B-SSH120-2848	918	+23	+50
28	54	B-SSH120-2854	957	+23	+50
28	60	B-SSH120-2860	1,002	+23	+50

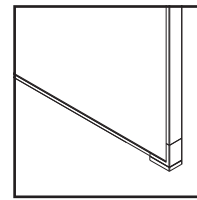
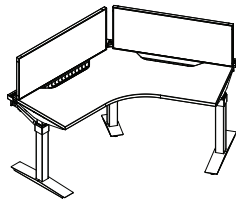
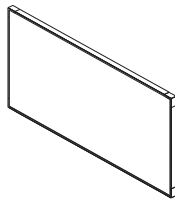

Surface Mount Slimline

Specify

- Paint Selection (Grade C +10)
- Fabric, Vinyl, Whiteboard or Laminate Selection

Notes

- For use with Aloft 120 benches only.
- Slimline screens may be fabric, vinyl, whiteboard or laminate on either side. Upcharges for Grade C and D are listed per side. Whiteboards are standard list and have no upcharge.
- Offered in all AIS paint finishes.

Aloft Worksurface Width Front/Rear Under Surface Mount Slimline Screens

Material	Where Used	Screen Type	Sized For	Mount Type
Fabric/Vinyl/Whiteboard/Laminate	Front/Rear on Worksurface	Slimline	Aloft WS Width	Under Surface Mount

ALOFT WORKSURFACE WIDTH FRONT/REAR UNDER SURFACE MOUNT SLIMLINE SCREENS

H	W	Model Number	List	Fabric Grade C	Fabric Grade D
12	36	B-SWMR1236	582	+7	+14
12	42	B-SWMR1242	614	+7	+14
12	48	B-SWMR1248	645	+7	+14
12	54	B-SWMR1254	678	+7	+14
12	60	B-SWMR1260	709	+7	+14
12	66	B-SWMR1266	920	+7	+14
12	72	B-SWMR1272	979	+7	+14
16	36	B-SWMR1636	650	+11	+22
16	42	B-SWMR1642	685	+11	+22
16	48	B-SWMR1648	722	+11	+22
16	54	B-SWMR1654	758	+11	+22
16	60	B-SWMR1660	793	+11	+22
16	66	B-SWMR1666	972	+11	+22
16	72	B-SWMR1672	1,032	+11	+22
20	36	B-SWMR2036	720	+15	+30
20	42	B-SWMR2042	759	+15	+30
20	48	B-SWMR2048	798	+15	+30
20	54	B-SWMR2054	835	+15	+30
20	60	B-SWMR2060	874	+15	+30
20	66	B-SWMR2066	1,022	+15	+30
20	72	B-SWMR2072	1,088	+15	+30

ALOFT WORKSURFACE WIDTH FRONT/REAR UNDER SURFACE MOUNT SLIMLINE SCREENS

H	W	Model Number	List	Fabric Grade C	Fabric Grade D
24	36	B-SWMR2436	789	+19	+38
24	42	B-SWMR2442	831	+19	+38
24	48	B-SWMR2448	874	+19	+38
24	54	B-SWMR2454	912	+19	+38
24	60	B-SWMR2460	956	+19	+38
24	66	B-SWMR2466	1,071	+19	+38
24	72	B-SWMR2472	1,141	+19	+38
28	36	B-SWMR2836	858	+25	+50
28	42	B-SWMR2842	904	+25	+50
28	48	B-SWMR2848	951	+25	+50
28	54	B-SWMR2854	991	+25	+50
28	60	B-SWMR2860	1,037	+25	+50
28	66	B-SWMR2866	1,122	+25	+50
28	72	B-SWMR2872	1,197	+25	+50

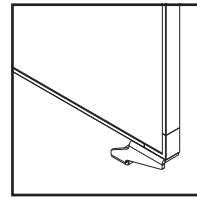
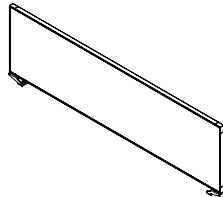

Under Surface Mount Slimline

Specify

- Paint Selection (Grade C +10)
- Fabric, Vinyl, Whiteboard or Laminate Selection

Notes

- Slimline screens may be fabric, vinyl, whiteboard or laminate on either side. Upcharges for Grade C and D are listed per side. Whiteboards are standard list and have no upcharge.
- Offered in all AIS paint finishes.

Aloft Worksurface Width Front/Rear Freestanding Slimline Screens

Material	Where Used	Screen Type	Sized For	Mount Type
Fabric/Vinyl/Whiteboard/Laminate	Front/Rear on Worksurface	Slimline	Aloft WS Width	Freestanding

ALOFT WORKSURFACE WIDTH FRONT/REAR FREESTANDINGSLIMLINE SCREENS

H	W	Model Number	List	Fabric Grade C	Fabric Grade D
12	36	Y-6R1H4U1236B	582	+7	+14
12	42	Y-6R1H4U1242B	613	+7	+14
12	48	Y-6R1H4U1248B	645	+7	+14
12	54	Y-6R1H4U1254B	678	+7	+14
12	60	Y-6R1H4U1260B	709	+7	+14
12	66	Y-6R1H4U1266B	920	+7	+14
12	72	Y-6R1H4U1272B	979	+7	+14
16	36	Y-6R1H4U1636B	650	+11	+22
16	42	Y-6R1H4U1642B	685	+11	+22
16	48	Y-6R1H4U1648B	722	+11	+22
16	54	Y-6R1H4U1654B	758	+11	+22
16	60	Y-6R1H4U1660B	793	+11	+22
16	66	Y-6R1H4U1666B	972	+11	+22
16	72	Y-6R1H4U1672B	1,032	+11	+22
20	36	Y-6R1H4U2036B	720	+15	+30
20	42	Y-6R1H4U2042B	759	+15	+30
20	48	Y-6R1H4U2048B	798	+15	+30
20	54	Y-6R1H4U2054B	835	+15	+30
20	60	Y-6R1H4U2060B	874	+15	+30
20	66	Y-6R1H4U2066B	1,022	+15	+30
20	72	Y-6R1H4U2072B	1,088	+15	+30

ALOFT WORKSURFACE WIDTH FRONT/REAR FREESTANDINGSLIMLINE SCREENS

H	W	Model Number	List	Fabric Grade C	Fabric Grade D
24	36	Y-6R1H4U2436B	789	+18	+36
24	42	Y-6R1H4U2442B	831	+18	+36
24	48	Y-6R1H4U2448B	874	+18	+36
24	54	Y-6R1H4U2454B	912	+18	+36
24	60	Y-6R1H4U2460B	956	+18	+36
24	66	Y-6R1H4U2466B	1,071	+18	+36
24	72	Y-6R1H4U2472B	1,141	+18	+36
28	36	Y-6R1H4U2836B	858	+21	+42
28	42	Y-6R1H4U2842B	904	+21	+42
28	48	Y-6R1H4U2848B	951	+21	+42
28	54	Y-6R1H4U2854B	991	+21	+42
28	60	Y-6R1H4U2860B	1,037	+21	+42
28	66	Y-6R1H4U2866B	1,122	+21	+42
28	72	Y-6R1H4U2872B	1,197	+21	+42

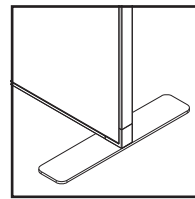
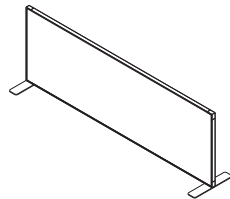

Freestanding Slimline

Specify

- Paint Selection (Grade C +10)
- Fabric, Vinyl, Whiteboard or Laminate Selection

Notes

- Slimline screens may be fabric, vinyl, whiteboard or laminate on either side. Upcharges for Grade C and D are listed per side. Whiteboards are standard list and have no upcharge.
- Offered in all AIS paint finishes.
- Non-marring feet measure 2 3/8" x 12".

Aloft Worksurface Width Universal Spine Mount Slimline Screens

Material	Where Used	Screen Type	Sized For	Mount Type
Fabric/Vinyl/Whiteboard/Laminate	Universal Spine	Slimline	Aloft WS Width	Spine Mount

ALOFT WORKSURFACE WIDTH UNIVERSAL SPINE MOUNT SLIMLINE SCREENS

H	W	Horizon Planning	Model Number	List	Fabric Grade C	Fabric Grade D
12	36	42"H Horizon	O-SSH1236	613	+7	+14
12	42	42"H Horizon	O-SSH1242	646	+7	+14
12	48	42"H Horizon	O-SSH1248	682	+7	+14
12	54	42"H Horizon	O-SSH1254	714	+7	+14
12	60	42"H Horizon	O-SSH1260	749	+7	+14
12	66	42"H Horizon	O-SSH1266	970	+7	+14
12	72	42"H Horizon	O-SSH1272	1,031	+7	+14
16	36	46"H Horizon	O-SSH1636	687	+11	+22
16	42	46"H Horizon	O-SSH1642	724	+11	+22
16	48	46"H Horizon	O-SSH1648	760	+11	+22
16	54	46"H Horizon	O-SSH1654	798	+11	+22
16	60	46"H Horizon	O-SSH1660	835	+11	+22
16	66	46"H Horizon	O-SSH1666	1,025	+11	+22
16	72	46"H Horizon	O-SSH1672	1,090	+11	+22
20	36	50"H Horizon	O-SSH2036	759	+15	+30
20	42	50"H Horizon	O-SSH2042	799	+15	+30
20	48	50"H Horizon	O-SSH2048	840	+15	+30
20	54	50"H Horizon	O-SSH2054	880	+15	+30
20	60	50"H Horizon	O-SSH2060	921	+15	+30
20	66	50"H Horizon	O-SSH2066	1,076	+15	+30
20	72	50"H Horizon	O-SSH2072	1,145	+15	+30

ALOFT WORKSURFACE WIDTH UNIVERSAL SPINE MOUNT SLIMLINE SCREENS

H	W	Horizon Planning	Model Number	List	Fabric Grade C	Fabric Grade D
24	36	54"H Horizon	O-SSH2436	830	+19	+38
24	42	54"H Horizon	O-SSH2442	874	+19	+38
24	48	54"H Horizon	O-SSH2448	921	+19	+38
24	54	54"H Horizon	O-SSH2454	964	+19	+38
24	60	54"H Horizon	O-SSH2460	1,007	+19	+38
24	66	54"H Horizon	O-SSH2466	1,129	+19	+38
24	72	54"H Horizon	O-SSH2472	1,199	+19	+38
28	36	58"H Horizon	O-SSH2836	901	+23	+46
28	42	58"H Horizon	O-SSH2842	950	+23	+46
28	48	58"H Horizon	O-SSH2848	1,001	+23	+46
28	54	58"H Horizon	O-SSH2854	1,048	+23	+46
28	60	58"H Horizon	O-SSH2860	1,092	+23	+46
28	66	58"H Horizon	O-SSH2866	1,181	+23	+46
28	72	58"H Horizon	O-SSH2872	1,253	+23	+46

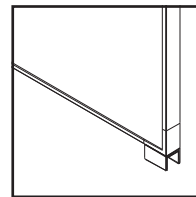
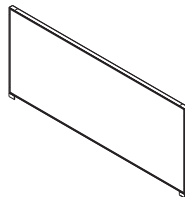

Spine Mount Slimline

Specify

- Paint Selection (Grade C +10)
- Fabric, Vinyl, Whiteboard or Laminate Selection

Notes

- Slimline screens may be fabric, vinyl, whiteboard or laminate on either side. Upcharges for Grade C and D are listed per side. Whiteboards are standard list and have no upcharge.
- Offered in all AIS paint finishes.

L-Wrap Screens Sized for Day-to-Day, Calibrate & E-Series HAT

PET Day-to-Day, Calibrate & E-Series HAT L-Wrap Under Surface Mount Lite Screens

Material	Where Used	Screen Type	Sized For	Mount Type	Handedness
PET	L-Wrap on Worksurface	Lite	L-Wrap for Day-to-Day, Calibrate & E-Series HAT	Under Surface Mount	Left or Right

PET DAY-TO-DAY, CALIBRATE & E-SERIES HAT L-WRAP UNDER SURFACE MOUNT LITE SCREENS

H	W	D	Left Hand	Right Hand	List
			Model Number	Model Number	
12	24	12	Y-5C4J2L121224B	Y-5C4J2R121224B	627
12	30	12	Y-5C4J2L121230B	Y-5C4J2R121230B	638
12	36	12	Y-5C4J2L121236B	Y-5C4J2R121236B	646
12	42	12	Y-5C4J2L121242B	Y-5C4J2R121242B	656
12	48	12	Y-5C4J2L121248B	Y-5C4J2R121248B	666
12	54	12	Y-5C4J2L121254B	Y-5C4J2R121254B	675
12	60	12	Y-5C4J2L121260B	Y-5C4J2R121260B	684
12	66	12	Y-5C4J2L121266B	Y-5C4J2R121266B	695
12	72	12	Y-5C4J2L121272B	Y-5C4J2R121272B	704
12	78	12	Y-5C4J2L121278B	Y-5C4J2R121278B	713
12	24	18	Y-5C4J2L121824B	Y-5C4J2R121824B	638
12	30	18	Y-5C4J2L121830B	Y-5C4J2R121830B	646
12	36	18	Y-5C4J2L121836B	Y-5C4J2R121836B	656
12	42	18	Y-5C4J2L121842B	Y-5C4J2R121842B	666
12	48	18	Y-5C4J2L121848B	Y-5C4J2R121848B	675
12	54	18	Y-5C4J2L121854B	Y-5C4J2R121854B	684
12	60	18	Y-5C4J2L121860B	Y-5C4J2R121860B	695
12	66	18	Y-5C4J2L121866B	Y-5C4J2R121866B	704
12	72	18	Y-5C4J2L121872B	Y-5C4J2R121872B	713

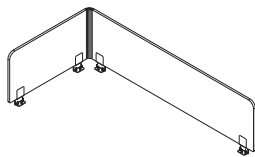

Left Hand

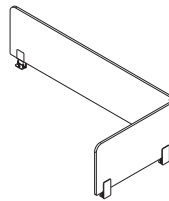

Right Hand

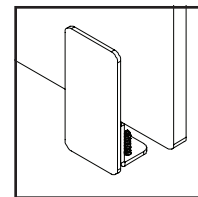

Under Surface Mount Lite

Specify

- Paint Selection for Lite Clip
- Color Selection for PET - Lite Grey, Medium Grey, Tan or Vibrant Blue

Notes

- PET L-Wrap Screens are designed to mount to AIS worksurfaces. Specify based on nominal size for the desired system. Order screens that correspond to worksurface width and depth.
- PET screen inserts are 1/2" (12mm) thick.

PET Day-to-Day, Calibrate & E-Series HAT L-Wrap Under Surface Mount Lite Screens

Material	Where Used	Screen Type	Sized For	Mount Type	Handedness
PET	L-Wrap on Worksurface	Lite	L-Wrap for Day-to-Day, Calibrate & E-Series HAT	Under Surface Mount	Left or Right

**PET DAY-TO-DAY, CALIBRATE & E-SERIES HAT
L-WRAP UNDER SURFACE MOUNT LITE SCREENS**

H	W	D	Left Hand	Right Hand	List
			Model Number	Model Number	
12	24	24	Y-5C4J2L122424B	Y-5C4J2R122424B	646
12	30	24	Y-5C4J2L122430B	Y-5C4J2R122430B	656
12	36	24	Y-5C4J2L122436B	Y-5C4J2R122436B	666
12	42	24	Y-5C4J2L122442B	Y-5C4J2R122442B	675
12	48	24	Y-5C4J2L122448B	Y-5C4J2R122448B	684
12	54	24	Y-5C4J2L122454B	Y-5C4J2R122454B	695
12	60	24	Y-5C4J2L122460B	Y-5C4J2R122460B	704
12	66	24	Y-5C4J2L122466B	Y-5C4J2R122466B	713
12	24	30	Y-5C4J2L123024B	Y-5C4J2R123024B	656
12	30	30	Y-5C4J2L123030B	Y-5C4J2R123030B	666
12	36	30	Y-5C4J2L123036B	Y-5C4J2R123036B	675
12	42	30	Y-5C4J2L123042B	Y-5C4J2R123042B	684
12	48	30	Y-5C4J2L123048B	Y-5C4J2R123048B	695
12	54	30	Y-5C4J2L123054B	Y-5C4J2R123054B	704
12	60	30	Y-5C4J2L123060B	Y-5C4J2R123060B	713

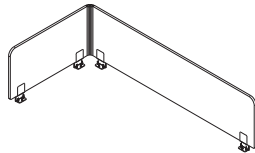

Left Hand

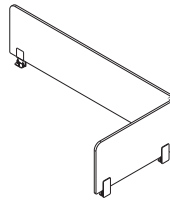

Right Hand

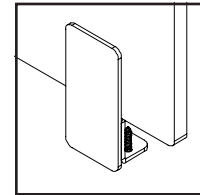

Under Surface Mount Lite

Specify

- Paint Selection for Lite Clip
- Color Selection for PET - Lite Grey, Medium Grey, Tan or Vibrant Blue

Notes

- PET L-Wrap Screens are designed to mount to AIS worksurfaces. Specify based on nominal size for the desired system. Order screens that correspond to worksurface width and depth.
- PET screen inserts are 1/2" (12mm) thick.

PET Day-to-Day, Calibrate & E-Series HAT L-Wrap Under Surface Mount Lite Screens

Material	Where Used	Screen Type	Sized For	Mount Type	Handedness
PET	L-Wrap on Worksurface	Lite	L-Wrap for Day-to-Day, Calibrate & E-Series HAT	Under Surface Mount	Left or Right

PET DAY-TO-DAY, CALIBRATE & E-SERIES HAT L-WRAP UNDER SURFACE MOUNT LITE SCREENS

H	W	D	Left Hand	Right Hand	List
			Model Number	Model Number	
12	24	36	Y-5C4J2L123624B	Y-5C4J2R123624B	666
12	30	36	Y-5C4J2L123630B	Y-5C4J2R123630B	675
12	36	36	Y-5C4J2L123636B	Y-5C4J2R123636B	684
12	42	36	Y-5C4J2L123642B	Y-5C4J2R123642B	695
12	48	36	Y-5C4J2L123648B	Y-5C4J2R123648B	704
12	54	36	Y-5C4J2L123654B	Y-5C4J2R123654B	713
12	24	42	Y-5C4J2L124224B	Y-5C4J2R124224B	675
12	30	42	Y-5C4J2L124230B	Y-5C4J2R124230B	684
12	36	42	Y-5C4J2L124236B	Y-5C4J2R124236B	695
12	42	42	Y-5C4J2L124242B	Y-5C4J2R124242B	704
12	48	42	Y-5C4J2L124248B	Y-5C4J2R124248B	713

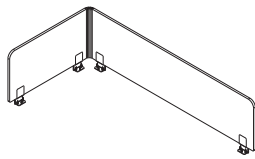

Left Hand

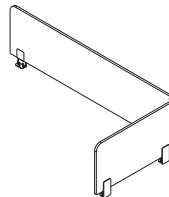

Right Hand

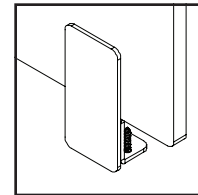

Under Surface Mount Lite

Specify

- Paint Selection for Lite Clip
- Color Selection for PET - Lite Grey, Medium Grey, Tan or Vibrant Blue

Notes

- PET L-Wrap Screens are designed to mount to AIS worksurfaces. Specify based on nominal size for the desired system. Order screens that correspond to worksurface width and depth.
- PET screen inserts are 1/2" (12mm) thick.

PET Day-to-Day, Calibrate & E-Series HAT L-Wrap Under Surface Mount Lite Screens

Material	Where Used	Screen Type	Sized For	Mount Type	Handedness
PET	L-Wrap on Worksurface	Lite	L-Wrap for Day-to-Day, Calibrate & E-Series HAT	Under Surface Mount	Left or Right

**PET DAY-TO-DAY, CALIBRATE & E-SERIES HAT
L-WRAP UNDER SURFACE MOUNT LITE SCREENS**

H	W	D	Left Hand	Right Hand	List
			Model Number	Model Number	
16	24	12	Y-5C4J2L161224B	Y-5C4J2R161224B	646
16	30	12	Y-5C4J2L161230B	Y-5C4J2R161230B	659
16	36	12	Y-5C4J2L161236B	Y-5C4J2R161236B	672
16	42	12	Y-5C4J2L161242B	Y-5C4J2R161242B	684
16	48	12	Y-5C4J2L161248B	Y-5C4J2R161248B	697
16	54	12	Y-5C4J2L161254B	Y-5C4J2R161254B	710
16	60	12	Y-5C4J2L161260B	Y-5C4J2R161260B	724
16	66	12	Y-5C4J2L161266B	Y-5C4J2R161266B	736
16	72	12	Y-5C4J2L161272B	Y-5C4J2R161272B	748
16	78	12	Y-5C4J2L161278B	Y-5C4J2R161278B	761
16	24	18	Y-5C4J2L161824B	Y-5C4J2R161824B	659
16	30	18	Y-5C4J2L161830B	Y-5C4J2R161830B	672
16	36	18	Y-5C4J2L161836B	Y-5C4J2R161836B	684
16	42	18	Y-5C4J2L161842B	Y-5C4J2R161842B	697
16	48	18	Y-5C4J2L161848B	Y-5C4J2R161848B	710
16	54	18	Y-5C4J2L161854B	Y-5C4J2R161854B	724
16	60	18	Y-5C4J2L161860B	Y-5C4J2R161860B	736
16	66	18	Y-5C4J2L161866B	Y-5C4J2R161866B	748
16	72	18	Y-5C4J2L161872B	Y-5C4J2R161872B	761

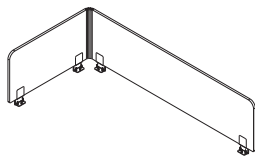

Left Hand

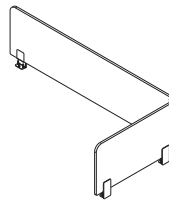

Right Hand

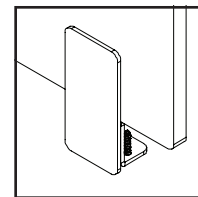

Under Surface Mount Lite

Specify

- Paint Selection for Lite Clip
- Color Selection for PET - Lite Grey, Medium Grey, Tan or Vibrant Blue

Notes

- PET L-Wrap Screens are designed to mount to AIS worksurfaces. Specify based on nominal size for the desired system. Order screens that correspond to worksurface width and depth.
- PET screen inserts are 1/2" (12mm) thick.

PET Day-to-Day, Calibrate & E-Series HAT L-Wrap Under Surface Mount Lite Screens

Material	Where Used	Screen Type	Sized For	Mount Type	Handedness
PET	L-Wrap on Worksurface	Lite	L-Wrap for Day-to-Day, Calibrate & E-Series HAT	Under Surface Mount	Left or Right

PET DAY-TO-DAY, CALIBRATE & E-SERIES HAT L-WRAP UNDER SURFACE MOUNT LITE SCREENS

H	W	D	Left Hand	Right Hand	List
			Model Number	Model Number	
16	24	24	Y-5C4J2L162424B	Y-5C4J2R162424B	672
16	30	24	Y-5C4J2L162430B	Y-5C4J2R162430B	684
16	36	24	Y-5C4J2L162436B	Y-5C4J2R162436B	697
16	42	24	Y-5C4J2L162442B	Y-5C4J2R162442B	710
16	48	24	Y-5C4J2L162448B	Y-5C4J2R162448B	724
16	54	24	Y-5C4J2L162454B	Y-5C4J2R162454B	736
16	60	24	Y-5C4J2L162460B	Y-5C4J2R162460B	748
16	66	24	Y-5C4J2L162466B	Y-5C4J2R162466B	761
16	24	30	Y-5C4J2L163024B	Y-5C4J2R163024B	684
16	30	30	Y-5C4J2L163030B	Y-5C4J2R163030B	697
16	36	30	Y-5C4J2L163036B	Y-5C4J2R163036B	710
16	42	30	Y-5C4J2L163042B	Y-5C4J2R163042B	724
16	48	30	Y-5C4J2L163048B	Y-5C4J2R163048B	736
16	54	30	Y-5C4J2L163054B	Y-5C4J2R163054B	748
16	60	30	Y-5C4J2L163060B	Y-5C4J2R163060B	761

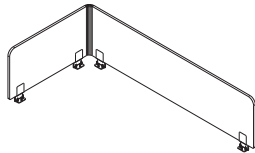

Left Hand

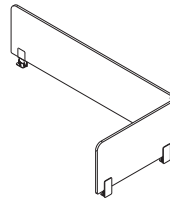

Right Hand

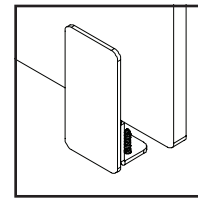

Under Surface Mount Lite

Specify

- Paint Selection for Lite Clip
- Color Selection for PET - Lite Grey, Medium Grey, Tan or Vibrant Blue

Notes

- PET L-Wrap Screens are designed to mount to AIS worksurfaces. Specify based on nominal size for the desired system. Order screens that correspond to worksurface width and depth.
- PET screen inserts are 1/2" (12mm) thick.

PET Day-to-Day, Calibrate & E-Series HAT L-Wrap Under Surface Mount Lite Screens

Material	Where Used	Screen Type	Sized For	Mount Type	Handedness
PET	L-Wrap on Worksurface	Lite	L-Wrap for Day-to-Day, Calibrate & E-Series HAT	Under Surface Mount	Left or Right

**PET DAY-TO-DAY, CALIBRATE & E-SERIES HAT
L-WRAP UNDER SURFACE MOUNT LITE SCREENS**

H	W	D	Left Hand	Right Hand	List
			Model Number	Model Number	
16	24	36	Y-5C4J2L163624B	Y-5C4J2R163624B	697
16	30	36	Y-5C4J2L163630B	Y-5C4J2R163630B	710
16	36	36	Y-5C4J2L163636B	Y-5C4J2R163636B	724
16	42	36	Y-5C4J2L163642B	Y-5C4J2R163642B	736
16	48	36	Y-5C4J2L163648B	Y-5C4J2R163648B	748
16	54	36	Y-5C4J2L163654B	Y-5C4J2R163654B	761
16	24	42	Y-5C4J2L164224B	Y-5C4J2R164224B	710
16	30	42	Y-5C4J2L164230B	Y-5C4J2R164230B	724
16	36	42	Y-5C4J2L164236B	Y-5C4J2R164236B	736
16	42	42	Y-5C4J2L164242B	Y-5C4J2R164242B	748
16	48	42	Y-5C4J2L164248B	Y-5C4J2R164248B	761

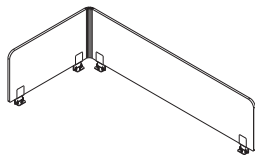

Left Hand

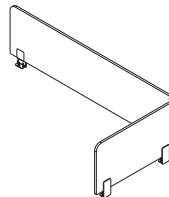

Right Hand

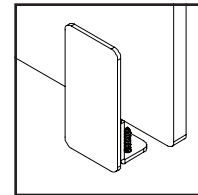

Under Surface Mount Lite

Specify

- Paint Selection for Lite Clip
- Color Selection for PET - Lite Grey, Medium Grey, Tan or Vibrant Blue

Notes

- PET L-Wrap Screens are designed to mount to AIS worksurfaces. Specify based on nominal size for the desired system. Order screens that correspond to worksurface width and depth.
- PET screen inserts are 1/2" (12mm) thick.

PET Day-to-Day, Calibrate & E-Series HAT L-Wrap Under Surface Mount Lite Screens

Material	Where Used	Screen Type	Sized For	Mount Type	Handedness
PET	L-Wrap on Worksurface	Lite	L-Wrap for Day-to-Day, Calibrate & E-Series HAT	Under Surface Mount	Left or Right

PET DAY-TO-DAY, CALIBRATE & E-SERIES HAT L-WRAP UNDER SURFACE MOUNT LITE SCREENS

H	W	D	Left Hand	Right Hand	List
			Model Number	Model Number	
20	24	12	Y-5C4J2L201224B	Y-5C4J2R201224B	666
20	30	12	Y-5C4J2L201230B	Y-5C4J2R201230B	682
20	36	12	Y-5C4J2L201236B	Y-5C4J2R201236B	697
20	42	12	Y-5C4J2L201242B	Y-5C4J2R201242B	713
20	48	12	Y-5C4J2L201248B	Y-5C4J2R201248B	729
20	54	12	Y-5C4J2L201254B	Y-5C4J2R201254B	746
20	60	12	Y-5C4J2L201260B	Y-5C4J2R201260B	761
20	66	12	Y-5C4J2L201266B	Y-5C4J2R201266B	776
20	72	12	Y-5C4J2L201272B	Y-5C4J2R201272B	794
20	78	12	Y-5C4J2L201278B	Y-5C4J2R201278B	808
20	24	18	Y-5C4J2L201824B	Y-5C4J2R201824B	682
20	30	18	Y-5C4J2L201830B	Y-5C4J2R201830B	697
20	36	18	Y-5C4J2L201836B	Y-5C4J2R201836B	713
20	42	18	Y-5C4J2L201842B	Y-5C4J2R201842B	729
20	48	18	Y-5C4J2L201848B	Y-5C4J2R201848B	746
20	54	18	Y-5C4J2L201854B	Y-5C4J2R201854B	761
20	60	18	Y-5C4J2L201860B	Y-5C4J2R201860B	776
20	66	18	Y-5C4J2L201866B	Y-5C4J2R201866B	794
20	72	18	Y-5C4J2L201872B	Y-5C4J2R201872B	808

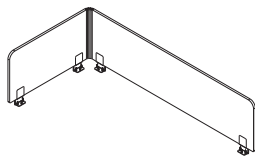

Left Hand

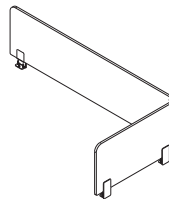

Right Hand

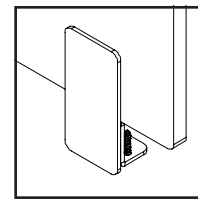

Under Surface Mount Lite

Specify

- Paint Selection for Lite Clip
- Color Selection for PET - Lite Grey, Medium Grey, Tan or Vibrant Blue

Notes

- PET L-Wrap Screens are designed to mount to AIS worksurfaces. Specify based on nominal size for the desired system. Order screens that correspond to worksurface width and depth.
- PET screen inserts are 1/2" (12mm) thick.

PET Day-to-Day, Calibrate & E-Series HAT L-Wrap Under Surface Mount Lite Screens

Material	Where Used	Screen Type	Sized For	Mount Type	Handedness
PET	L-Wrap on Worksurface	Lite	L-Wrap for Day-to-Day, Calibrate & E-Series HAT	Under Surface Mount	Left or Right

**PET DAY-TO-DAY, CALIBRATE & E-SERIES HAT
L-WRAP UNDER SURFACE MOUNT LITE SCREENS**

H	W	D	Left Hand	Right Hand	List
			Model Number	Model Number	
20	24	24	Y-5C4J2L202424B	Y-5C4J2R202424B	697
20	30	24	Y-5C4J2L202430B	Y-5C4J2R202430B	713
20	36	24	Y-5C4J2L202436B	Y-5C4J2R202436B	729
20	42	24	Y-5C4J2L202442B	Y-5C4J2R202442B	746
20	48	24	Y-5C4J2L202448B	Y-5C4J2R202448B	761
20	54	24	Y-5C4J2L202454B	Y-5C4J2R202454B	776
20	60	24	Y-5C4J2L202460B	Y-5C4J2R202460B	794
20	66	24	Y-5C4J2L202466B	Y-5C4J2R202466B	808
20	24	30	Y-5C4J2L203024B	Y-5C4J2R203024B	713
20	30	30	Y-5C4J2L203030B	Y-5C4J2R203030B	729
20	36	30	Y-5C4J2L203036B	Y-5C4J2R203036B	746
20	42	30	Y-5C4J2L203042B	Y-5C4J2R203042B	761
20	48	30	Y-5C4J2L203048B	Y-5C4J2R203048B	776
20	54	30	Y-5C4J2L203054B	Y-5C4J2R203054B	794
20	60	30	Y-5C4J2L203060B	Y-5C4J2R203060B	808

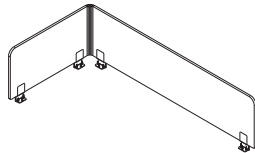

Left Hand

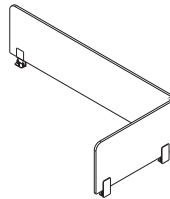

Right Hand

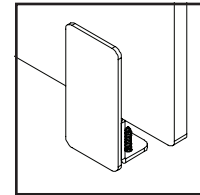

Under Surface Mount Lite

Specify

- Paint Selection for Lite Clip
- Color Selection for PET - Lite Grey, Medium Grey, Tan or Vibrant Blue

Notes

- PET L-Wrap Screens are designed to mount to AIS worksurfaces. Specify based on nominal size for the desired system. Order screens that correspond to worksurface width and depth.
- PET screen inserts are 1/2" (12mm) thick.

PET Day-to-Day, Calibrate & E-Series HAT L-Wrap Under Surface Mount Lite Screens

Material	Where Used	Screen Type	Sized For	Mount Type	Handedness
PET	L-Wrap on Worksurface	Lite	L-Wrap for Day-to-Day, Calibrate & E-Series HAT	Under Surface Mount	Left or Right

PET DAY-TO-DAY, CALIBRATE & E-SERIES HAT L-WRAP UNDER SURFACE MOUNT LITE SCREENS

H	W	D	Left Hand	Right Hand	List
			Model Number	Model Number	
20	24	36	Y-5C4J2L203624B	Y-5C4J2R203624B	729
20	30	36	Y-5C4J2L203630B	Y-5C4J2R203630B	746
20	36	36	Y-5C4J2L203636B	Y-5C4J2R203636B	761
20	42	36	Y-5C4J2L203642B	Y-5C4J2R203642B	776
20	48	36	Y-5C4J2L203648B	Y-5C4J2R203648B	794
20	54	36	Y-5C4J2L203654B	Y-5C4J2R203654B	808
20	24	42	Y-5C4J2L204224B	Y-5C4J2R204224B	746
20	30	42	Y-5C4J2L204230B	Y-5C4J2R204230B	761
20	36	42	Y-5C4J2L204236B	Y-5C4J2R204236B	776
20	42	42	Y-5C4J2L204242B	Y-5C4J2R204242B	794
20	48	42	Y-5C4J2L204248B	Y-5C4J2R204248B	808

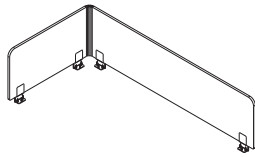

Left Hand

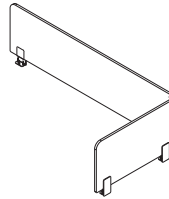

Right Hand

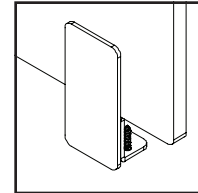

Under Surface Mount Lite

Specify

- Paint Selection for Lite Clip
- Color Selection for PET - Lite Grey, Medium Grey, Tan or Vibrant Blue

Notes

- PET L-Wrap Screens are designed to mount to AIS worksurfaces. Specify based on nominal size for the desired system. Order screens that correspond to worksurface width and depth.
- PET screen inserts are 1/2" (12mm) thick.

PET Day-to-Day, Calibrate & E-Series HAT L-Wrap Under Surface Mount Lite Screens

Material	Where Used	Screen Type	Sized For	Mount Type	Handedness
PET	L-Wrap on Worksurface	Lite	L-Wrap for Day-to-Day, Calibrate & E-Series HAT	Under Surface Mount	Left or Right

**PET DAY-TO-DAY, CALIBRATE & E-SERIES HAT
L-WRAP UNDER SURFACE MOUNT LITE SCREENS**

H	W	D	Left Hand	Right Hand	List
			Model Number	Model Number	
24	24	12	Y-5C4J2L241224B	Y-5C4J2R241224B	684
24	30	12	Y-5C4J2L241230B	Y-5C4J2R241230B	704
24	36	12	Y-5C4J2L241236B	Y-5C4J2R241236B	724
24	42	12	Y-5C4J2L241242B	Y-5C4J2R241242B	740
24	48	12	Y-5C4J2L241248B	Y-5C4J2R241248B	761
24	54	12	Y-5C4J2L241254B	Y-5C4J2R241254B	779
24	60	12	Y-5C4J2L241260B	Y-5C4J2R241260B	800
24	66	12	Y-5C4J2L241266B	Y-5C4J2R241266B	818
24	72	12	Y-5C4J2L241272B	Y-5C4J2R241272B	837
24	78	12	Y-5C4J2L241278B	Y-5C4J2R241278B	858
24	24	18	Y-5C4J2L241824B	Y-5C4J2R241824B	704
24	30	18	Y-5C4J2L241830B	Y-5C4J2R241830B	724
24	36	18	Y-5C4J2L241836B	Y-5C4J2R241836B	740
24	42	18	Y-5C4J2L241842B	Y-5C4J2R241842B	761
24	48	18	Y-5C4J2L241848B	Y-5C4J2R241848B	779
24	54	18	Y-5C4J2L241854B	Y-5C4J2R241854B	800
24	60	18	Y-5C4J2L241860B	Y-5C4J2R241860B	818
24	66	18	Y-5C4J2L241866B	Y-5C4J2R241866B	837
24	72	18	Y-5C4J2L241872B	Y-5C4J2R241872B	858

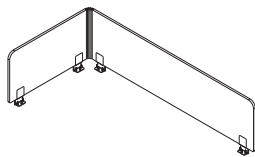

Left Hand

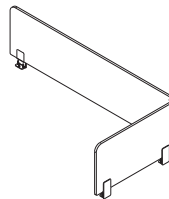

Right Hand

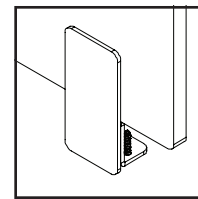

Under Surface Mount Lite

Specify

- Paint Selection for Lite Clip
- Color Selection for PET - Lite Grey, Medium Grey, Tan or Vibrant Blue

Notes

- PET L-Wrap Screens are designed to mount to AIS worksurfaces. Specify based on nominal size for the desired system. Order screens that correspond to worksurface width and depth.
- PET screen inserts are 1/2" (12mm) thick.

PET Day-to-Day, Calibrate & E-Series HAT L-Wrap Under Surface Mount Lite Screens

Material	Where Used	Screen Type	Sized For	Mount Type	Handedness
PET	L-Wrap on Worksurface	Lite	L-Wrap for Day-to-Day, Calibrate & E-Series HAT	Under Surface Mount	Left or Right

PET DAY-TO-DAY, CALIBRATE & E-SERIES HAT L-WRAP UNDER SURFACE MOUNT LITE SCREENS

H	W	D	Left Hand	Right Hand	List
			Model Number	Model Number	
24	24	24	Y-5C4J2L242424B	Y-5C4J2R242424B	724
24	30	24	Y-5C4J2L242430B	Y-5C4J2R242430B	740
24	36	24	Y-5C4J2L242436B	Y-5C4J2R242436B	761
24	42	24	Y-5C4J2L242442B	Y-5C4J2R242442B	779
24	48	24	Y-5C4J2L242448B	Y-5C4J2R242448B	800
24	54	24	Y-5C4J2L242454B	Y-5C4J2R242454B	818
24	60	24	Y-5C4J2L242460B	Y-5C4J2R242460B	837
24	66	24	Y-5C4J2L242466B	Y-5C4J2R242466B	858
24	24	30	Y-5C4J2L243024B	Y-5C4J2R243024B	740
24	30	30	Y-5C4J2L243030B	Y-5C4J2R243030B	761
24	36	30	Y-5C4J2L243036B	Y-5C4J2R243036B	779
24	42	30	Y-5C4J2L243042B	Y-5C4J2R243042B	800
24	48	30	Y-5C4J2L243048B	Y-5C4J2R243048B	818
24	54	30	Y-5C4J2L243054B	Y-5C4J2R243054B	837
24	60	30	Y-5C4J2L243060B	Y-5C4J2R243060B	858

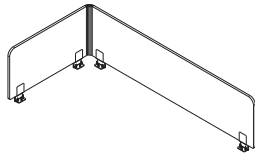

Left Hand

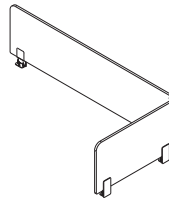

Right Hand

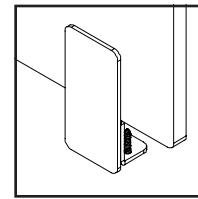

Under Surface Mount Lite

Specify

- Paint Selection for Lite Clip
- Color Selection for PET - Lite Grey, Medium Grey, Tan or Vibrant Blue

Notes

- PET L-Wrap Screens are designed to mount to AIS worksurfaces. Specify based on nominal size for the desired system. Order screens that correspond to worksurface width and depth.
- PET screen inserts are 1/2" (12mm) thick.

PET Day-to-Day, Calibrate & E-Series HAT L-Wrap Under Surface Mount Lite Screens

Material	Where Used	Screen Type	Sized For	Mount Type	Handedness
PET	L-Wrap on Worksurface	Lite	L-Wrap for Day-to-Day, Calibrate & E-Series HAT	Under Surface Mount	Left or Right

**PET DAY-TO-DAY, CALIBRATE & E-SERIES HAT
L-WRAP UNDER SURFACE MOUNT LITE SCREENS**

H	W	D	Left Hand	Right Hand	List
			Model Number	Model Number	
24	24	36	Y-5C4J2L243624B	Y-5C4J2R243624B	761
24	30	36	Y-5C4J2L243630B	Y-5C4J2R243630B	779
24	36	36	Y-5C4J2L243636B	Y-5C4J2R243636B	800
24	42	36	Y-5C4J2L243642B	Y-5C4J2R243642B	818
24	48	36	Y-5C4J2L243648B	Y-5C4J2R243648B	837
24	54	36	Y-5C4J2L243654B	Y-5C4J2R243654B	858
24	24	42	Y-5C4J2L244224B	Y-5C4J2R244224B	779
24	30	42	Y-5C4J2L244230B	Y-5C4J2R244230B	800
24	36	42	Y-5C4J2L244236B	Y-5C4J2R244236B	818
24	42	42	Y-5C4J2L244242B	Y-5C4J2R244242B	837
24	48	42	Y-5C4J2L244248B	Y-5C4J2R244248B	858

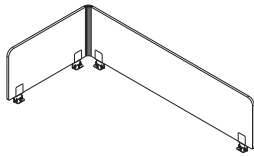

Left Hand

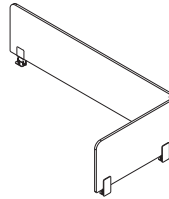

Right Hand

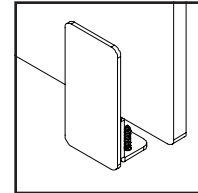

Under Surface Mount Lite

Specify

- Paint Selection for Lite Clip
- Color Selection for PET - Lite Grey, Medium Grey, Tan or Vibrant Blue

Notes

- PET L-Wrap Screens are designed to mount to AIS worksurfaces. Specify based on nominal size for the desired system. Order screens that correspond to worksurface width and depth.
- PET screen inserts are 1/2" (12mm) thick.

PET Day-to-Day, Calibrate & E-Series HAT L-Wrap Under Surface Mount Lite Screens

Material	Where Used	Screen Type	Sized For	Mount Type	Handedness
PET	L-Wrap on Worksurface	Lite	L-Wrap for Day-to-Day, Calibrate & E-Series HAT	Under Surface Mount	Left or Right

PET DAY-TO-DAY, CALIBRATE & E-SERIES HAT L-WRAP UNDER SURFACE MOUNT LITE SCREENS

H	W	D	Left Hand	Right Hand	List
			Model Number	Model Number	
28	24	12	Y-5C4J2L281224B	Y-5C4J2R281224B	704
28	30	12	Y-5C4J2L281230B	Y-5C4J2R281230B	726
28	36	12	Y-5C4J2L281236B	Y-5C4J2R281236B	748
28	42	12	Y-5C4J2L281242B	Y-5C4J2R281242B	769
28	48	12	Y-5C4J2L281248B	Y-5C4J2R281248B	794
28	54	12	Y-5C4J2L281254B	Y-5C4J2R281254B	815
28	60	12	Y-5C4J2L281260B	Y-5C4J2R281260B	837
28	66	12	Y-5C4J2L281266B	Y-5C4J2R281266B	860
28	72	12	Y-5C4J2L281272B	Y-5C4J2R281272B	881
28	78	12	Y-5C4J2L281278B	Y-5C4J2R281278B	904
28	24	18	Y-5C4J2L281824B	Y-5C4J2R281824B	726
28	30	18	Y-5C4J2L281830B	Y-5C4J2R281830B	748
28	36	18	Y-5C4J2L281836B	Y-5C4J2R281836B	769
28	42	18	Y-5C4J2L281842B	Y-5C4J2R281842B	794
28	48	18	Y-5C4J2L281848B	Y-5C4J2R281848B	815
28	54	18	Y-5C4J2L281854B	Y-5C4J2R281854B	837
28	60	18	Y-5C4J2L281860B	Y-5C4J2R281860B	860
28	66	18	Y-5C4J2L281866B	Y-5C4J2R281866B	881
28	72	18	Y-5C4J2L281872B	Y-5C4J2R281872B	904

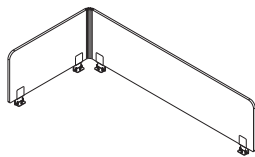

Left Hand

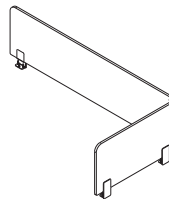

Right Hand

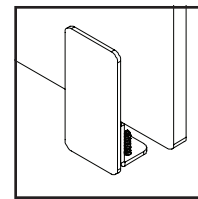

Under Surface Mount Lite

Specify

- Paint Selection for Lite Clip
- Color Selection for PET - Lite Grey, Medium Grey, Tan or Vibrant Blue

Notes

- PET L-Wrap Screens are designed to mount to AIS worksurfaces. Specify based on nominal size for the desired system. Order screens that correspond to worksurface width and depth.
- PET screen inserts are 1/2" (12mm) thick.

PET Day-to-Day, Calibrate & E-Series HAT L-Wrap Under Surface Mount Lite Screens

Material	Where Used	Screen Type	Sized For	Mount Type	Handedness
PET	L-Wrap on Worksurface	Lite	L-Wrap for Day-to-Day, Calibrate & E-Series HAT	Under Surface Mount	Left or Right

**PET DAY-TO-DAY, CALIBRATE & E-SERIES HAT
L-WRAP UNDER SURFACE MOUNT LITE SCREENS**

H	W	D	Left Hand	Right Hand	List
			Model Number	Model Number	
28	24	24	Y-5C4J2L282424B	Y-5C4J2R282424B	748
28	30	24	Y-5C4J2L282430B	Y-5C4J2R282430B	769
28	36	24	Y-5C4J2L282436B	Y-5C4J2R282436B	794
28	42	24	Y-5C4J2L282442B	Y-5C4J2R282442B	815
28	48	24	Y-5C4J2L282448B	Y-5C4J2R282448B	837
28	54	24	Y-5C4J2L282454B	Y-5C4J2R282454B	860
28	60	24	Y-5C4J2L282460B	Y-5C4J2R282460B	881
28	66	24	Y-5C4J2L282466B	Y-5C4J2R282466B	904
28	24	30	Y-5C4J2L283024B	Y-5C4J2R283024B	769
28	30	30	Y-5C4J2L283030B	Y-5C4J2R283030B	794
28	36	30	Y-5C4J2L283036B	Y-5C4J2R283036B	815
28	42	30	Y-5C4J2L283042B	Y-5C4J2R283042B	837
28	48	30	Y-5C4J2L283048B	Y-5C4J2R283048B	860
28	54	30	Y-5C4J2L283054B	Y-5C4J2R283054B	881
28	60	30	Y-5C4J2L283060B	Y-5C4J2R283060B	904

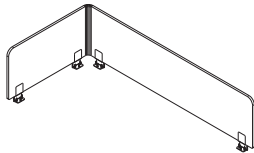

Left Hand

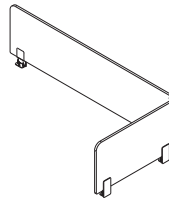

Right Hand

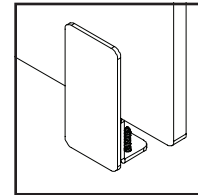

Under Surface Mount Lite

Specify

- Paint Selection for Lite Clip
- Color Selection for PET - Lite Grey, Medium Grey, Tan or Vibrant Blue

Notes

- PET L-Wrap Screens are designed to mount to AIS worksurfaces. Specify based on nominal size for the desired system. Order screens that correspond to worksurface width and depth.
- PET screen inserts are 1/2" (12mm) thick.

PET Day-to-Day, Calibrate & E-Series HAT L-Wrap Under Surface Mount Lite Screens

Material	Where Used	Screen Type	Sized For	Mount Type	Handedness
PET	L-Wrap on Worksurface	Lite	L-Wrap for Day-to-Day, Calibrate & E-Series HAT	Under Surface Mount	Left or Right

PET DAY-TO-DAY, CALIBRATE & E-SERIES HAT L-WRAP UNDER SURFACE MOUNT LITE SCREENS

H	W	D	Left Hand	Right Hand	List
			Model Number	Model Number	
28	24	36	Y-5C4J2L283624B	Y-5C4J2R283624B	794
28	30	36	Y-5C4J2L283630B	Y-5C4J2R283630B	815
28	36	36	Y-5C4J2L283636B	Y-5C4J2R283636B	837
28	42	36	Y-5C4J2L283642B	Y-5C4J2R283642B	860
28	48	36	Y-5C4J2L283648B	Y-5C4J2R283648B	881
28	54	36	Y-5C4J2L283654B	Y-5C4J2R283654B	904
28	24	42	Y-5C4J2L284224B	Y-5C4J2R284224B	815
28	30	42	Y-5C4J2L284230B	Y-5C4J2R284230B	837
28	36	42	Y-5C4J2L284236B	Y-5C4J2R284236B	860
28	42	42	Y-5C4J2L284242B	Y-5C4J2R284242B	881
28	48	42	Y-5C4J2L284248B	Y-5C4J2R284248B	904

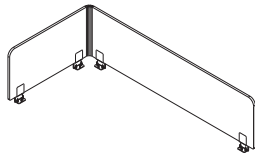

Left Hand

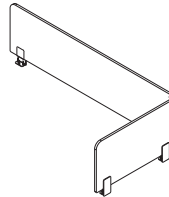

Right Hand

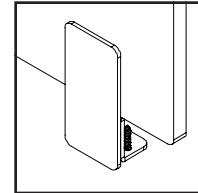

Under Surface Mount Lite

Specify

- Paint Selection for Lite Clip
- Color Selection for PET - Lite Grey, Medium Grey, Tan or Vibrant Blue

Notes

- PET L-Wrap Screens are designed to mount to AIS worksurfaces. Specify based on nominal size for the desired system. Order screens that correspond to worksurface width and depth.
- PET screen inserts are 1/2" (12mm) thick.

PET Day-to-Day, Calibrate & E-Series HAT L-Wrap Under Surface Mount Lite Screens

Material	Where Used	Screen Type	Sized For	Mount Type	Handedness
PET	L-Wrap on Worksurface	Lite	L-Wrap for Day-to-Day, Calibrate & E-Series HAT	Under Surface Mount	Left or Right

**PET DAY-TO-DAY, CALIBRATE & E-SERIES HAT
L-WRAP UNDER SURFACE MOUNT LITE SCREENS**

H	W	D	Left Hand	Right Hand	List
			Model Number	Model Number	
32	24	12	Y-5C4J2L321224B	Y-5C4J2R321224B	786
32	30	12	Y-5C4J2L321230B	Y-5C4J2R321230B	820
32	36	12	Y-5C4J2L321236B	Y-5C4J2R321236B	856
32	42	12	Y-5C4J2L321242B	Y-5C4J2R321242B	890
32	48	12	Y-5C4J2L321248B	Y-5C4J2R321248B	927
32	54	12	Y-5C4J2L321254B	Y-5C4J2R321254B	962
32	60	12	Y-5C4J2L321260B	Y-5C4J2R321260B	997
32	66	12	Y-5C4J2L321266B	Y-5C4J2R321266B	1,033
32	72	12	Y-5C4J2L321272B	Y-5C4J2R321272B	1,069
32	78	12	Y-5C4J2L321278B	Y-5C4J2R321278B	1,105
32	24	18	Y-5C4J2L321824B	Y-5C4J2R321824B	820
32	30	18	Y-5C4J2L321830B	Y-5C4J2R321830B	856
32	36	18	Y-5C4J2L321836B	Y-5C4J2R321836B	890
32	42	18	Y-5C4J2L321842B	Y-5C4J2R321842B	927
32	48	18	Y-5C4J2L321848B	Y-5C4J2R321848B	962
32	54	18	Y-5C4J2L321854B	Y-5C4J2R321854B	997
32	60	18	Y-5C4J2L321860B	Y-5C4J2R321860B	1,033
32	66	18	Y-5C4J2L321866B	Y-5C4J2R321866B	1,069
32	72	18	Y-5C4J2L321872B	Y-5C4J2R321872B	1,105

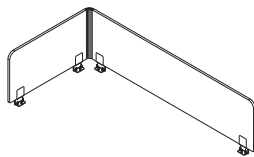

Left Hand

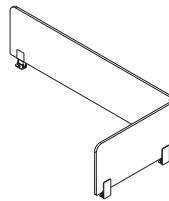

Right Hand

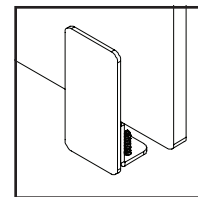

Under Surface Mount Lite

Specify

- Paint Selection for Lite Clip
- Color Selection for PET - Lite Grey, Medium Grey, Tan or Vibrant Blue

Notes

- PET L-Wrap Screens are designed to mount to AIS worksurfaces. Specify based on nominal size for the desired system. Order screens that correspond to worksurface width and depth.
- PET screen inserts are 1/2" (12mm) thick.

PET Day-to-Day, Calibrate & E-Series HAT L-Wrap Under Surface Mount Lite Screens

Material	Where Used	Screen Type	Sized For	Mount Type	Handedness
PET	L-Wrap on Worksurface	Lite	L-Wrap for Day-to-Day, Calibrate & E-Series HAT	Under Surface Mount	Left or Right

PET DAY-TO-DAY, CALIBRATE & E-SERIES HAT L-WRAP UNDER SURFACE MOUNT LITE SCREENS

H	W	D	Left Hand	Right Hand	List
			Model Number	Model Number	
32	24	24	Y-5C4J2L322424B	Y-5C4J2R322424B	856
32	30	24	Y-5C4J2L322430B	Y-5C4J2R322430B	890
32	36	24	Y-5C4J2L322436B	Y-5C4J2R322436B	927
32	42	24	Y-5C4J2L322442B	Y-5C4J2R322442B	962
32	48	24	Y-5C4J2L322448B	Y-5C4J2R322448B	997
32	54	24	Y-5C4J2L322454B	Y-5C4J2R322454B	1,033
32	60	24	Y-5C4J2L322460B	Y-5C4J2R322460B	1,069
32	66	24	Y-5C4J2L322466B	Y-5C4J2R322466B	1,105
32	24	30	Y-5C4J2L323024B	Y-5C4J2R323024B	890
32	30	30	Y-5C4J2L323030B	Y-5C4J2R323030B	927
32	36	30	Y-5C4J2L323036B	Y-5C4J2R323036B	962
32	42	30	Y-5C4J2L323042B	Y-5C4J2R323042B	997
32	48	30	Y-5C4J2L323048B	Y-5C4J2R323048B	1,033
32	54	30	Y-5C4J2L323054B	Y-5C4J2R323054B	1,069
32	60	30	Y-5C4J2L323060B	Y-5C4J2R323060B	1,105

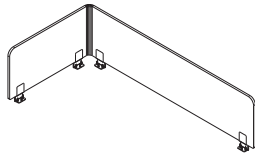

Left Hand

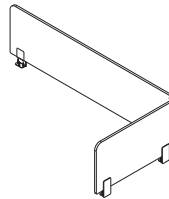

Right Hand

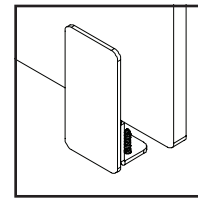

Under Surface Mount Lite

Specify

- Paint Selection for Lite Clip
- Color Selection for PET - Lite Grey, Medium Grey, Tan or Vibrant Blue

Notes

- PET L-Wrap Screens are designed to mount to AIS worksurfaces. Specify based on nominal size for the desired system. Order screens that correspond to worksurface width and depth.
- PET screen inserts are 1/2" (12mm) thick.

PET Day-to-Day, Calibrate & E-Series HAT L-Wrap Under Surface Mount Lite Screens

Material	Where Used	Screen Type	Sized For	Mount Type	Handedness
PET	L-Wrap on Worksurface	Lite	L-Wrap for Day-to-Day, Calibrate & E-Series HAT	Under Surface Mount	Left or Right

**PET DAY-TO-DAY, CALIBRATE & E-SERIES HAT
L-WRAP UNDER SURFACE MOUNT LITE SCREENS**

H	W	D	Left Hand	Right Hand	List
			Model Number	Model Number	
32	24	36	Y-5C4J2L323624B	Y-5C4J2R323624B	927
32	30	36	Y-5C4J2L323630B	Y-5C4J2R323630B	962
32	36	36	Y-5C4J2L323636B	Y-5C4J2R323636B	997
32	42	36	Y-5C4J2L323642B	Y-5C4J2R323642B	1,033
32	48	36	Y-5C4J2L323648B	Y-5C4J2R323648B	1,069
32	54	36	Y-5C4J2L323654B	Y-5C4J2R323654B	1,105
32	24	42	Y-5C4J2L324224B	Y-5C4J2R324224B	962
32	30	42	Y-5C4J2L324230B	Y-5C4J2R324230B	997
32	36	42	Y-5C4J2L324236B	Y-5C4J2R324236B	1,033
32	42	42	Y-5C4J2L324242B	Y-5C4J2R324242B	1,069
32	48	42	Y-5C4J2L324248B	Y-5C4J2R324248B	1,105

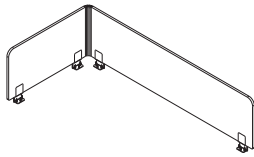

Left Hand

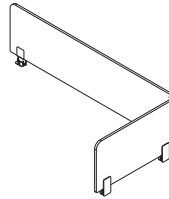

Right Hand

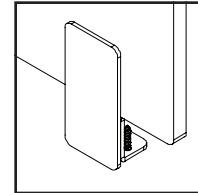

Under Surface Mount Lite

Specify

- Paint Selection for Lite Clip
- Color Selection for PET - Lite Grey, Medium Grey, Tan or Vibrant Blue

Notes

- PET L-Wrap Screens are designed to mount to AIS worksurfaces. Specify based on nominal size for the desired system. Order screens that correspond to worksurface width and depth.
- PET screen inserts are 1/2" (12mm) thick.

PET Day-to-Day, Calibrate & E-Series HAT L-Wrap Partial Modesty Under Surface Mount Lite Screens

Material	Where Used	Screen Type	Sized For	Mount Type	Handedness
PET	L-Wrap Partial Modesty on WS	Lite	L-Wrap for Day-to-Day, Calibrate & E-Series HAT	Under Surface Mount	Left or Right

PET DAY-TO-DAY, CALIBRATE & E-SERIES HAT L-WRAP PARTIAL MODESTY UNDER SURFACE MOUNT LITE SCREENS

H	W	D	Left Hand	Right Hand	List
			Model Number	Model Number	
22	24	12	Y-5M4J2L221224B	Y-5M4J2R221224B	675
22	30	12	Y-5M4J2L221230B	Y-5M4J2R221230B	693
22	36	12	Y-5M4J2L221236B	Y-5M4J2R221236B	710
22	42	12	Y-5M4J2L221242B	Y-5M4J2R221242B	727
22	48	12	Y-5M4J2L221248B	Y-5M4J2R221248B	746
22	54	12	Y-5M4J2L221254B	Y-5M4J2R221254B	763
22	60	12	Y-5M4J2L221260B	Y-5M4J2R221260B	779
22	66	12	Y-5M4J2L221266B	Y-5M4J2R221266B	798
22	72	12	Y-5M4J2L221272B	Y-5M4J2R221272B	815
22	78	12	Y-5M4J2L221278B	Y-5M4J2R221278B	833
22	24	18	Y-5M4J2L221824B	Y-5M4J2R221824B	693
22	30	18	Y-5M4J2L221830B	Y-5M4J2R221830B	710
22	36	18	Y-5M4J2L221836B	Y-5M4J2R221836B	727
22	42	18	Y-5M4J2L221842B	Y-5M4J2R221842B	746
22	48	18	Y-5M4J2L221848B	Y-5M4J2R221848B	763
22	54	18	Y-5M4J2L221854B	Y-5M4J2R221854B	779
22	60	18	Y-5M4J2L221860B	Y-5M4J2R221860B	798
22	66	18	Y-5M4J2L221866B	Y-5M4J2R221866B	815
22	72	18	Y-5M4J2L221872B	Y-5M4J2R221872B	833

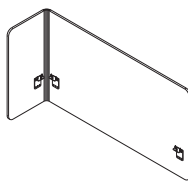

Left Hand

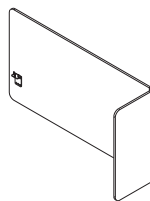

Right Hand

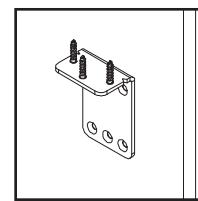

Under Surface Mount Lite

Specify

- Paint Selection for Lite Clip
- Color Selection for PET - Lite Grey, Medium Grey, Tan or Vibrant Blue

Notes

- PET L-Wrap Screens are designed to mount to AIS worksurfaces. Specify based on nominal size for the desired system. Order screens that correspond to worksurface width and depth.
- PET screen inserts are 1/2" (12mm) thick.

PET Day-to-Day, Calibrate & E-Series HAT L-Wrap Partial Modesty Under Surface Mount Lite Screens

Material	Where Used	Screen Type	Sized For	Mount Type	Handedness
PET	L-Wrap Partial Modesty on WS	Lite	L-Wrap for Day-to-Day, Calibrate & E-Series HAT	Under Surface Mount	Left or Right

**PET DAY-TO-DAY, CALIBRATE & E-SERIES HAT
L-WRAP PARTIAL MODESTY UNDER SURFACE MOUNT LITE SCREENS**

H	W	D	Left Hand	Right Hand	List
			Model Number	Model Number	
22	24	24	Y-5M4J2L222424B	Y-5M4J2R222424B	710
22	30	24	Y-5M4J2L222430B	Y-5M4J2R222430B	727
22	36	24	Y-5M4J2L222436B	Y-5M4J2R222436B	746
22	42	24	Y-5M4J2L222442B	Y-5M4J2R222442B	763
22	48	24	Y-5M4J2L222448B	Y-5M4J2R222448B	779
22	54	24	Y-5M4J2L222454B	Y-5M4J2R222454B	798
22	60	24	Y-5M4J2L222460B	Y-5M4J2R222460B	815
22	66	24	Y-5M4J2L222466B	Y-5M4J2R222466B	833
22	24	30	Y-5M4J2L223024B	Y-5M4J2R223024B	727
22	30	30	Y-5M4J2L223030B	Y-5M4J2R223030B	746
22	36	30	Y-5M4J2L223036B	Y-5M4J2R223036B	763
22	42	30	Y-5M4J2L223042B	Y-5M4J2R223042B	779
22	48	30	Y-5M4J2L223048B	Y-5M4J2R223048B	798
22	54	30	Y-5M4J2L223054B	Y-5M4J2R223054B	815
22	60	30	Y-5M4J2L223060B	Y-5M4J2R223060B	833

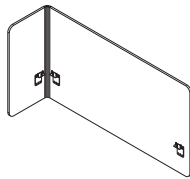

Left Hand

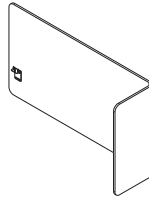

Right Hand

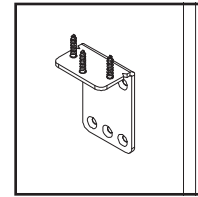

Under Surface Mount Lite

Specify

- Paint Selection for Lite Clip
- Color Selection for PET - Lite Grey, Medium Grey, Tan or Vibrant Blue

Notes

- PET L-Wrap Screens are designed to mount to AIS worksurfaces. Specify based on nominal size for the desired system. Order screens that correspond to worksurface width and depth.
- PET screen inserts are 1/2" (12mm) thick.

PET Day-to-Day, Calibrate & E-Series HAT L-Wrap Partial Modesty Under Surface Mount Lite Screens

Material	Where Used	Screen Type	Sized For	Mount Type	Handedness
PET	L-Wrap Partial Modesty on WS	Lite	L-Wrap for Day-to-Day, Calibrate & E-Series HAT	Under Surface Mount	Left or Right

PET DAY-TO-DAY, CALIBRATE & E-SERIES HAT L-WRAP PARTIAL MODESTY UNDER SURFACE MOUNT LITE SCREENS

H	W	D	Left Hand	Right Hand	List
			Model Number	Model Number	
22	24	36	Y-5M4J2L223624B	Y-5M4J2R223624B	746
22	30	36	Y-5M4J2L223630B	Y-5M4J2R223630B	763
22	36	36	Y-5M4J2L223636B	Y-5M4J2R223636B	779
22	42	36	Y-5M4J2L223642B	Y-5M4J2R223642B	798
22	48	36	Y-5M4J2L223648B	Y-5M4J2R223648B	815
22	54	36	Y-5M4J2L223654B	Y-5M4J2R223654B	833
22	24	42	Y-5M4J2L224224B	Y-5M4J2R224224B	763
22	30	42	Y-5M4J2L224230B	Y-5M4J2R224230B	779
22	36	42	Y-5M4J2L224236B	Y-5M4J2R224236B	798
22	42	42	Y-5M4J2L224242B	Y-5M4J2R224242B	815
22	48	42	Y-5M4J2L224248B	Y-5M4J2R224248B	833

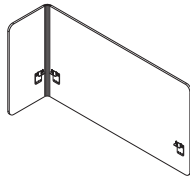

Left Hand

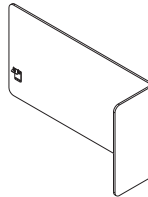

Right Hand

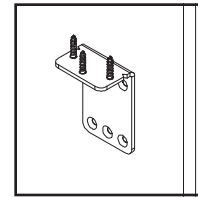

Under Surface Mount Lite

Specify

- Paint Selection for Lite Clip
- Color Selection for PET - Lite Grey, Medium Grey, Tan or Vibrant Blue

Notes

- PET L-Wrap Screens are designed to mount to AIS worksurfaces. Specify based on nominal size for the desired system. Order screens that correspond to worksurface width and depth.
- PET screen inserts are 1/2" (12mm) thick.

PET Day-to-Day, Calibrate & E-Series HAT L-Wrap Partial Modesty Under Surface Mount Lite Screens

Material	Where Used	Screen Type	Sized For	Mount Type	Handedness
PET	L-Wrap Partial Modesty on WS	Lite	L-Wrap for Day-to-Day, Calibrate & E-Series HAT	Under Surface Mount	Left or Right

**PET DAY-TO-DAY, CALIBRATE & E-SERIES HAT
L-WRAP PARTIAL MODESTY UNDER SURFACE MOUNT LITE SCREENS**

H	W	D	Left Hand	Right Hand	List
			Model Number	Model Number	
26	24	12	Y-5M4J2L261224B	Y-5M4J2R261224B	695
26	30	12	Y-5M4J2L261230B	Y-5M4J2R261230B	715
26	36	12	Y-5M4J2L261236B	Y-5M4J2R261236B	736
26	42	12	Y-5M4J2L261242B	Y-5M4J2R261242B	756
26	48	12	Y-5M4J2L261248B	Y-5M4J2R261248B	776
26	54	12	Y-5M4J2L261254B	Y-5M4J2R261254B	798
26	60	12	Y-5M4J2L261260B	Y-5M4J2R261260B	818
26	66	12	Y-5M4J2L261266B	Y-5M4J2R261266B	839
26	72	12	Y-5M4J2L261272B	Y-5M4J2R261272B	860
26	78	12	Y-5M4J2L261278B	Y-5M4J2R261278B	880
26	24	18	Y-5M4J2L261824B	Y-5M4J2R261824B	715
26	30	18	Y-5M4J2L261830B	Y-5M4J2R261830B	736
26	36	18	Y-5M4J2L261836B	Y-5M4J2R261836B	756
26	42	18	Y-5M4J2L261842B	Y-5M4J2R261842B	776
26	48	18	Y-5M4J2L261848B	Y-5M4J2R261848B	798
26	54	18	Y-5M4J2L261854B	Y-5M4J2R261854B	818
26	60	18	Y-5M4J2L261860B	Y-5M4J2R261860B	839
26	66	18	Y-5M4J2L261866B	Y-5M4J2R261866B	860
26	72	18	Y-5M4J2L261872B	Y-5M4J2R261872B	880

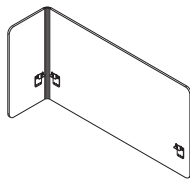

Left Hand

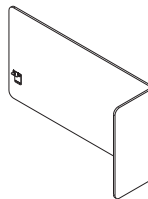

Right Hand

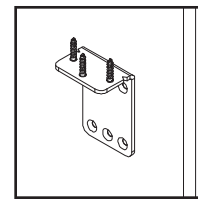

Under Surface Mount Lite

Specify

- Paint Selection for Lite Clip
- Color Selection for PET - Lite Grey, Medium Grey, Tan or Vibrant Blue

Notes

- PET L-Wrap Screens are designed to mount to AIS worksurfaces. Specify based on nominal size for the desired system. Order screens that correspond to worksurface width and depth.
- PET screen inserts are 1/2" (12mm) thick.

PET Day-to-Day, Calibrate & E-Series HAT L-Wrap Partial Modesty Under Surface Mount Lite Screens

Material	Where Used	Screen Type	Sized For	Mount Type	Handedness
PET	L-Wrap Partial Modesty on WS	Lite	L-Wrap for Day-to-Day, Calibrate & E-Series HAT	Under Surface Mount	Left or Right

PET DAY-TO-DAY, CALIBRATE & E-SERIES HAT L-WRAP PARTIAL MODESTY UNDER SURFACE MOUNT LITE SCREENS

H	W	D	Left Hand	Right Hand	List
			Model Number	Model Number	
26	24	24	Y-5M4J2L262424B	Y-5M4J2R262424B	736
26	30	24	Y-5M4J2L262430B	Y-5M4J2R262430B	756
26	36	24	Y-5M4J2L262436B	Y-5M4J2R262436B	776
26	42	24	Y-5M4J2L262442B	Y-5M4J2R262442B	798
26	48	24	Y-5M4J2L262448B	Y-5M4J2R262448B	818
26	54	24	Y-5M4J2L262454B	Y-5M4J2R262454B	839
26	60	24	Y-5M4J2L262460B	Y-5M4J2R262460B	860
26	66	24	Y-5M4J2L262466B	Y-5M4J2R262466B	880
26	24	30	Y-5M4J2L263024B	Y-5M4J2R263024B	756
26	30	30	Y-5M4J2L263030B	Y-5M4J2R263030B	776
26	36	30	Y-5M4J2L263036B	Y-5M4J2R263036B	798
26	42	30	Y-5M4J2L263042B	Y-5M4J2R263042B	818
26	48	30	Y-5M4J2L263048B	Y-5M4J2R263048B	839
26	54	30	Y-5M4J2L263054B	Y-5M4J2R263054B	860
26	60	30	Y-5M4J2L263060B	Y-5M4J2R263060B	880

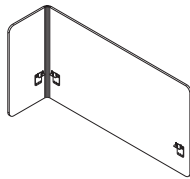

Left Hand

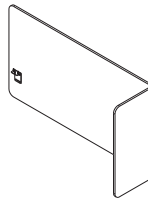

Right Hand

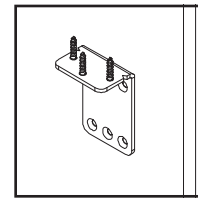

Under Surface Mount Lite

Specify

- Paint Selection for Lite Clip
- Color Selection for PET - Lite Grey, Medium Grey, Tan or Vibrant Blue

Notes

- PET L-Wrap Screens are designed to mount to AIS worksurfaces. Specify based on nominal size for the desired system. Order screens that correspond to worksurface width and depth.
- PET screen inserts are 1/2" (12mm) thick.

PET Day-to-Day, Calibrate & E-Series HAT L-Wrap Partial Modesty Under Surface Mount Lite Screens

Material	Where Used	Screen Type	Sized For	Mount Type	Handedness
PET	L-Wrap Partial Modesty on WS	Lite	L-Wrap for Day-to-Day, Calibrate & E-Series HAT	Under Surface Mount	Left or Right

**PET DAY-TO-DAY, CALIBRATE & E-SERIES HAT
L-WRAP PARTIAL MODESTY UNDER SURFACE MOUNT LITE SCREENS**

H	W	D	Left Hand	Right Hand	List
			Model Number	Model Number	
26	24	36	Y-5M4J2L263624B	Y-5M4J2R263624B	776
26	30	36	Y-5M4J2L263630B	Y-5M4J2R263630B	798
26	36	36	Y-5M4J2L263636B	Y-5M4J2R263636B	818
26	42	36	Y-5M4J2L263642B	Y-5M4J2R263642B	839
26	48	36	Y-5M4J2L263648B	Y-5M4J2R263648B	860
26	54	36	Y-5M4J2L263654B	Y-5M4J2R263654B	880
26	24	42	Y-5M4J2L264224B	Y-5M4J2R264224B	798
26	30	42	Y-5M4J2L264230B	Y-5M4J2R264230B	818
26	36	42	Y-5M4J2L264236B	Y-5M4J2R264236B	839
26	42	42	Y-5M4J2L264242B	Y-5M4J2R264242B	860
26	48	42	Y-5M4J2L264248B	Y-5M4J2R264248B	880

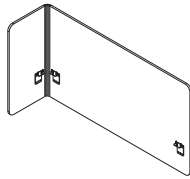

Left Hand

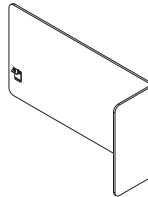

Right Hand

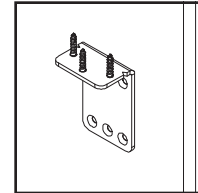

Under Surface Mount Lite

Specify

- Paint Selection for Lite Clip
- Color Selection for PET - Lite Grey, Medium Grey, Tan or Vibrant Blue

Notes

- PET L-Wrap Screens are designed to mount to AIS worksurfaces. Specify based on nominal size for the desired system. Order screens that correspond to worksurface width and depth.
- PET screen inserts are 1/2" (12mm) thick.

PET Day-to-Day, Calibrate & E-Series HAT L-Wrap Partial Modesty Under Surface Mount Lite Screens

Material	Where Used	Screen Type	Sized For	Mount Type	Handedness
PET	L-Wrap Partial Modesty on WS	Lite	L-Wrap for Day-to-Day, Calibrate & E-Series HAT	Under Surface Mount	Left or Right

PET DAY-TO-DAY, CALIBRATE & E-SERIES HAT L-WRAP PARTIAL MODESTY UNDER SURFACE MOUNT LITE SCREENS

H	W	D	Left Hand	Right Hand	List
			Model Number	Model Number	
34	24	12	Y-5M4J2L341224B	Y-5M4J2R341224B	798
34	30	12	Y-5M4J2L341230B	Y-5M4J2R341230B	835
34	36	12	Y-5M4J2L341236B	Y-5M4J2R341236B	873
34	42	12	Y-5M4J2L341242B	Y-5M4J2R341242B	911
34	48	12	Y-5M4J2L341248B	Y-5M4J2R341248B	950
34	54	12	Y-5M4J2L341254B	Y-5M4J2R341254B	988
34	60	12	Y-5M4J2L341260B	Y-5M4J2R341260B	1,025
34	66	12	Y-5M4J2L341266B	Y-5M4J2R341266B	1,062
34	72	12	Y-5M4J2L341272B	Y-5M4J2R341272B	1,100
34	78	12	Y-5M4J2L341278B	Y-5M4J2R341278B	1,139
34	24	18	Y-5M4J2L341824B	Y-5M4J2R341824B	835
34	30	18	Y-5M4J2L341830B	Y-5M4J2R341830B	873
34	36	18	Y-5M4J2L341836B	Y-5M4J2R341836B	911
34	42	18	Y-5M4J2L341842B	Y-5M4J2R341842B	950
34	48	18	Y-5M4J2L341848B	Y-5M4J2R341848B	988
34	54	18	Y-5M4J2L341854B	Y-5M4J2R341854B	1,025
34	60	18	Y-5M4J2L341860B	Y-5M4J2R341860B	1,062
34	66	18	Y-5M4J2L341866B	Y-5M4J2R341866B	1,100
34	72	18	Y-5M4J2L341872B	Y-5M4J2R341872B	1,139

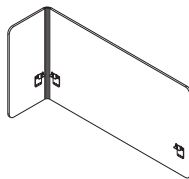

Left Hand

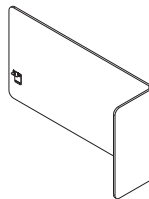

Right Hand

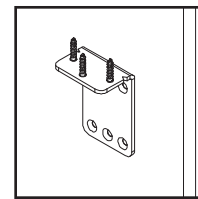

Under Surface Mount Lite

Specify

- Paint Selection for Lite Clip
- Color Selection for PET - Lite Grey, Medium Grey, Tan or Vibrant Blue

Notes

- PET L-Wrap Screens are designed to mount to AIS worksurfaces. Specify based on nominal size for the desired system. Order screens that correspond to worksurface width and depth.
- PET screen inserts are 1/2" (12mm) thick.

PET Day-to-Day, Calibrate & E-Series HAT L-Wrap Partial Modesty Under Surface Mount Lite Screens

Material	Where Used	Screen Type	Sized For	Mount Type	Handedness
PET	L-Wrap Partial Modesty on WS	Lite	L-Wrap for Day-to-Day, Calibrate & E-Series HAT	Under Surface Mount	Left or Right

**PET DAY-TO-DAY, CALIBRATE & E-SERIES HAT
L-WRAP PARTIAL MODESTY UNDER SURFACE MOUNT LITE SCREENS**

H	W	D	Left Hand	Right Hand	List
			Model Number	Model Number	
34	24	24	Y-5M4J2L342424B	Y-5M4J2R342424B	873
34	30	24	Y-5M4J2L342430B	Y-5M4J2R342430B	911
34	36	24	Y-5M4J2L342436B	Y-5M4J2R342436B	950
34	42	24	Y-5M4J2L342442B	Y-5M4J2R342442B	988
34	48	24	Y-5M4J2L342448B	Y-5M4J2R342448B	1,025
34	54	24	Y-5M4J2L342454B	Y-5M4J2R342454B	1,062
34	60	24	Y-5M4J2L342460B	Y-5M4J2R342460B	1,100
34	66	24	Y-5M4J2L342466B	Y-5M4J2R342466B	1,139
34	24	30	Y-5M4J2L343024B	Y-5M4J2R343024B	911
34	30	30	Y-5M4J2L343030B	Y-5M4J2R343030B	950
34	36	30	Y-5M4J2L343036B	Y-5M4J2R343036B	988
34	42	30	Y-5M4J2L343042B	Y-5M4J2R343042B	1,025
34	48	30	Y-5M4J2L343048B	Y-5M4J2R343048B	1,062
34	54	30	Y-5M4J2L343054B	Y-5M4J2R343054B	1,100
34	60	30	Y-5M4J2L343060B	Y-5M4J2R343060B	1,139

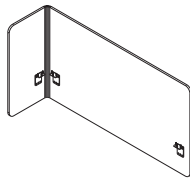

Left Hand

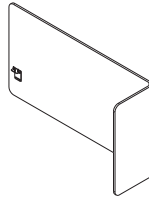

Right Hand

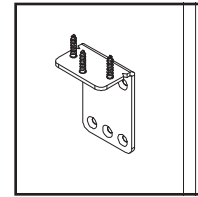

Under Surface Mount Lite

Specify

- Paint Selection for Lite Clip
- Color Selection for PET - Lite Grey, Medium Grey, Tan or Vibrant Blue

Notes

- PET L-Wrap Screens are designed to mount to AIS worksurfaces. Specify based on nominal size for the desired system. Order screens that correspond to worksurface width and depth.
- PET screen inserts are 1/2" (12mm) thick.

PET Day-to-Day, Calibrate & E-Series HAT L-Wrap Partial Modesty Under Surface Mount Lite Screens

Material	Where Used	Screen Type	Sized For	Mount Type	Handedness
PET	L-Wrap Partial Modesty on WS	Lite	L-Wrap for Day-to-Day, Calibrate & E-Series HAT	Under Surface Mount	Left or Right

PET DAY-TO-DAY, CALIBRATE & E-SERIES HAT L-WRAP PARTIAL MODESTY UNDER SURFACE MOUNT LITE SCREENS

H	W	D	Left Hand	Right Hand	List
			Model Number	Model Number	
34	24	36	Y-5M4J2L343624B	Y-5M4J2R343624B	950
34	30	36	Y-5M4J2L343630B	Y-5M4J2R343630B	988
34	36	36	Y-5M4J2L343636B	Y-5M4J2R343636B	1,025
34	42	36	Y-5M4J2L343642B	Y-5M4J2R343642B	1,062
34	48	36	Y-5M4J2L343648B	Y-5M4J2R343648B	1,100
34	54	36	Y-5M4J2L343654B	Y-5M4J2R343654B	1,139
34	24	42	Y-5M4J2L344224B	Y-5M4J2R344224B	988
34	30	42	Y-5M4J2L344230B	Y-5M4J2R344230B	1,025
34	36	42	Y-5M4J2L344236B	Y-5M4J2R344236B	1,062
34	42	42	Y-5M4J2L344242B	Y-5M4J2R344242B	1,100
34	48	42	Y-5M4J2L344248B	Y-5M4J2R344248B	1,139

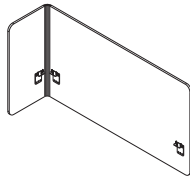

Left Hand

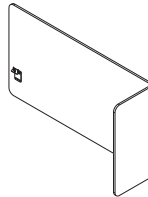

Right Hand

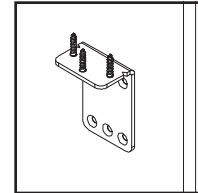

Under Surface Mount Lite

Specify

- Paint Selection for Lite Clip
- Color Selection for PET - Lite Grey, Medium Grey, Tan or Vibrant Blue

Notes

- PET L-Wrap Screens are designed to mount to AIS worksurfaces. Specify based on nominal size for the desired system. Order screens that correspond to worksurface width and depth.
- PET screen inserts are 1/2" (12mm) thick.

PET Day-to-Day, Calibrate & E-Series HAT L-Wrap Partial Modesty Under Surface Mount Lite Screens

Material	Where Used	Screen Type	Sized For	Mount Type	Handedness
PET	L-Wrap Partial Modesty on WS	Lite	L-Wrap for Day-to-Day, Calibrate & E-Series HAT	Under Surface Mount	Left or Right

**PET DAY-TO-DAY, CALIBRATE & E-SERIES HAT
L-WRAP PARTIAL MODESTY UNDER SURFACE MOUNT LITE SCREENS**

H	W	D	Left Hand	Right Hand	List
			Model Number	Model Number	
38	24	12	Y-5M4J2L381224B	Y-5M4J2R381224B	826
38	30	12	Y-5M4J2L381230B	Y-5M4J2R381230B	867
38	36	12	Y-5M4J2L381236B	Y-5M4J2R381236B	909
38	42	12	Y-5M4J2L381242B	Y-5M4J2R381242B	951
38	48	12	Y-5M4J2L381248B	Y-5M4J2R381248B	994
38	54	12	Y-5M4J2L381254B	Y-5M4J2R381254B	1,036
38	60	12	Y-5M4J2L381260B	Y-5M4J2R381260B	1,077
38	66	12	Y-5M4J2L381266B	Y-5M4J2R381266B	1,122
38	72	12	Y-5M4J2L381272B	Y-5M4J2R381272B	1,163
38	78	12	Y-5M4J2L381278B	Y-5M4J2R381278B	1,206
38	24	18	Y-5M4J2L381824B	Y-5M4J2R381824B	867
38	30	18	Y-5M4J2L381830B	Y-5M4J2R381830B	909
38	36	18	Y-5M4J2L381836B	Y-5M4J2R381836B	951
38	42	18	Y-5M4J2L381842B	Y-5M4J2R381842B	994
38	48	18	Y-5M4J2L381848B	Y-5M4J2R381848B	1,036
38	54	18	Y-5M4J2L381854B	Y-5M4J2R381854B	1,077
38	60	18	Y-5M4J2L381860B	Y-5M4J2R381860B	1,122
38	66	18	Y-5M4J2L381866B	Y-5M4J2R381866B	1,163
38	72	18	Y-5M4J2L381872B	Y-5M4J2R381872B	1,206

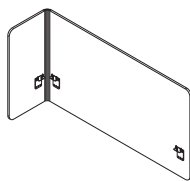

Left Hand

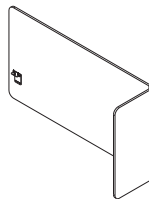

Right Hand

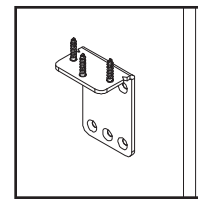

Under Surface Mount Lite

Specify

- Paint Selection for Lite Clip
- Color Selection for PET - Lite Grey, Medium Grey, Tan or Vibrant Blue

Notes

- PET L-Wrap Screens are designed to mount to AIS worksurfaces. Specify based on nominal size for the desired system. Order screens that correspond to worksurface width and depth.
- PET screen inserts are 1/2" (12mm) thick.

PET Day-to-Day, Calibrate & E-Series HAT L-Wrap Partial Modesty Under Surface Mount Lite Screens

Material	Where Used	Screen Type	Sized For	Mount Type	Handedness
PET	L-Wrap Partial Modesty on WS	Lite	L-Wrap for Day-to-Day, Calibrate & E-Series HAT	Under Surface Mount	Left or Right

PET DAY-TO-DAY, CALIBRATE & E-SERIES HAT L-WRAP PARTIAL MODESTY UNDER SURFACE MOUNT LITE SCREENS

H	W	D	Left Hand	Right Hand	List
			Model Number	Model Number	
38	24	24	Y-5M4J2L382424B	Y-5M4J2R382424B	909
38	30	24	Y-5M4J2L382430B	Y-5M4J2R382430B	951
38	36	24	Y-5M4J2L382436B	Y-5M4J2R382436B	994
38	42	24	Y-5M4J2L382442B	Y-5M4J2R382442B	1,036
38	48	24	Y-5M4J2L382448B	Y-5M4J2R382448B	1,077
38	54	24	Y-5M4J2L382454B	Y-5M4J2R382454B	1,122
38	60	24	Y-5M4J2L382460B	Y-5M4J2R382460B	1,163
38	66	24	Y-5M4J2L382466B	Y-5M4J2R382466B	1,206
38	24	30	Y-5M4J2L383024B	Y-5M4J2R383024B	951
38	30	30	Y-5M4J2L383030B	Y-5M4J2R383030B	994
38	36	30	Y-5M4J2L383036B	Y-5M4J2R383036B	1,036
38	42	30	Y-5M4J2L383042B	Y-5M4J2R383042B	1,077
38	48	30	Y-5M4J2L383048B	Y-5M4J2R383048B	1,122
38	54	30	Y-5M4J2L383054B	Y-5M4J2R383054B	1,163
38	60	30	Y-5M4J2L383060B	Y-5M4J2R383060B	1,206

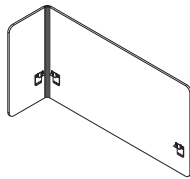

Left Hand

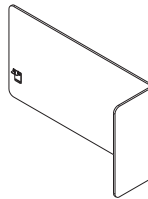

Right Hand

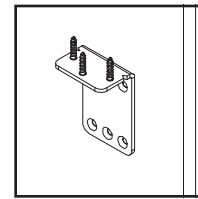

Under Surface Mount Lite

Specify

- Paint Selection for Lite Clip
- Color Selection for PET - Lite Grey, Medium Grey, Tan or Vibrant Blue

Notes

- PET L-Wrap Screens are designed to mount to AIS worksurfaces. Specify based on nominal size for the desired system. Order screens that correspond to worksurface width and depth.
- PET screen inserts are 1/2" (12mm) thick.

PET Day-to-Day, Calibrate & E-Series HAT L-Wrap Partial Modesty Under Surface Mount Lite Screens

Material	Where Used	Screen Type	Sized For	Mount Type	Handedness
PET	L-Wrap Partial Modesty on WS	Lite	L-Wrap for Day-to-Day, Calibrate & E-Series HAT	Under Surface Mount	Left or Right

**PET DAY-TO-DAY, CALIBRATE & E-SERIES HAT
L-WRAP PARTIAL MODESTY UNDER SURFACE MOUNT LITE SCREENS**

H	W	D	Left Hand	Right Hand	List
			Model Number	Model Number	
38	24	36	Y-5M4J2L383624B	Y-5M4J2R383624B	994
38	30	36	Y-5M4J2L383630B	Y-5M4J2R383630B	1,036
38	36	36	Y-5M4J2L383636B	Y-5M4J2R383636B	1,077
38	42	36	Y-5M4J2L383642B	Y-5M4J2R383642B	1,122
38	48	36	Y-5M4J2L383648B	Y-5M4J2R383648B	1,163
38	54	36	Y-5M4J2L383654B	Y-5M4J2R383654B	1,206
38	24	42	Y-5M4J2L384224B	Y-5M4J2R384224B	1,036
38	30	42	Y-5M4J2L384230B	Y-5M4J2R384230B	1,077
38	36	42	Y-5M4J2L384236B	Y-5M4J2R384236B	1,122
38	42	42	Y-5M4J2L384242B	Y-5M4J2R384242B	1,163
38	48	42	Y-5M4J2L384248B	Y-5M4J2R384248B	1,206

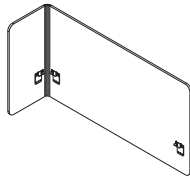

Left Hand

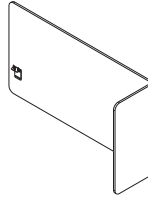

Right Hand

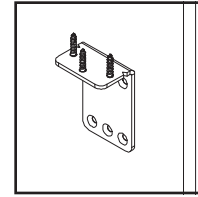

Under Surface Mount Lite

Specify

- Paint Selection for Lite Clip
- Color Selection for PET - Lite Grey, Medium Grey, Tan or Vibrant Blue

Notes

- PET L-Wrap Screens are designed to mount to AIS worksurfaces. Specify based on nominal size for the desired system. Order screens that correspond to worksurface width and depth.
- PET screen inserts are 1/2" (12mm) thick.

PET Day-to-Day, Calibrate & E-Series HAT L-Wrap Partial Modesty Under Surface Mount Lite Screens

Material	Where Used	Screen Type	Sized For	Mount Type	Handedness
PET	L-Wrap Partial Modesty on WS	Lite	L-Wrap for Day-to-Day, Calibrate & E-Series HAT	Under Surface Mount	Left or Right

PET DAY-TO-DAY, CALIBRATE & E-SERIES HAT L-WRAP PARTIAL MODESTY UNDER SURFACE MOUNT LITE SCREENS

H	W	D	Left Hand	Right Hand	List
			Model Number	Model Number	
42	24	12	Y-5M4J2L421224B	Y-5M4J2R421224B	850
42	30	12	Y-5M4J2L421230B	Y-5M4J2R421230B	898
42	36	12	Y-5M4J2L421236B	Y-5M4J2R421236B	944
42	42	12	Y-5M4J2L421242B	Y-5M4J2R421242B	991
42	48	12	Y-5M4J2L421248B	Y-5M4J2R421248B	1,037
42	54	12	Y-5M4J2L421254B	Y-5M4J2R421254B	1,086
42	60	12	Y-5M4J2L421260B	Y-5M4J2R421260B	1,131
42	66	12	Y-5M4J2L421266B	Y-5M4J2R421266B	1,179
42	72	12	Y-5M4J2L421272B	Y-5M4J2R421272B	1,224
42	78	12	Y-5M4J2L421278B	Y-5M4J2R421278B	1,274
42	24	18	Y-5M4J2L421824B	Y-5M4J2R421824B	898
42	30	18	Y-5M4J2L421830B	Y-5M4J2R421830B	944
42	36	18	Y-5M4J2L421836B	Y-5M4J2R421836B	991
42	42	18	Y-5M4J2L421842B	Y-5M4J2R421842B	1,037
42	48	18	Y-5M4J2L421848B	Y-5M4J2R421848B	1,086
42	54	18	Y-5M4J2L421854B	Y-5M4J2R421854B	1,131
42	60	18	Y-5M4J2L421860B	Y-5M4J2R421860B	1,179
42	66	18	Y-5M4J2L421866B	Y-5M4J2R421866B	1,224
42	72	18	Y-5M4J2L421872B	Y-5M4J2R421872B	1,274

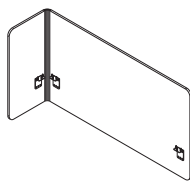

Left Hand

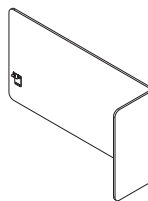

Right Hand

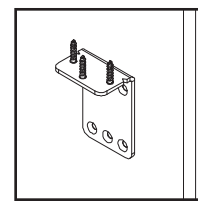

Under Surface Mount Lite

Specify

- Paint Selection for Lite Clip
- Color Selection for PET - Lite Grey, Medium Grey, Tan or Vibrant Blue

Notes

- PET L-Wrap Screens are designed to mount to AIS worksurfaces. Specify based on nominal size for the desired system. Order screens that correspond to worksurface width and depth.
- PET screen inserts are 1/2" (12mm) thick.

PET Day-to-Day, Calibrate & E-Series HAT L-Wrap Partial Modesty Under Surface Mount Lite Screens

Material	Where Used	Screen Type	Sized For	Mount Type	Handedness
PET	L-Wrap Partial Modesty on WS	Lite	L-Wrap for Day-to-Day, Calibrate & E-Series HAT	Under Surface Mount	Left or Right

**PET DAY-TO-DAY, CALIBRATE & E-SERIES HAT
L-WRAP PARTIAL MODESTY UNDER SURFACE MOUNT LITE SCREENS**

H	W	D	Left Hand	Right Hand	List
			Model Number	Model Number	
42	24	24	Y-5M4J2L422424B	Y-5M4J2R422424B	944
42	30	24	Y-5M4J2L422430B	Y-5M4J2R422430B	991
42	36	24	Y-5M4J2L422436B	Y-5M4J2R422436B	1,037
42	42	24	Y-5M4J2L422442B	Y-5M4J2R422442B	1,086
42	48	24	Y-5M4J2L422448B	Y-5M4J2R422448B	1,131
42	54	24	Y-5M4J2L422454B	Y-5M4J2R422454B	1,179
42	60	24	Y-5M4J2L422460B	Y-5M4J2R422460B	1,224
42	66	24	Y-5M4J2L422466B	Y-5M4J2R422466B	1,274
42	24	30	Y-5M4J2L423024B	Y-5M4J2R423024B	991
42	30	30	Y-5M4J2L423030B	Y-5M4J2R423030B	1,037
42	36	30	Y-5M4J2L423036B	Y-5M4J2R423036B	1,086
42	42	30	Y-5M4J2L423042B	Y-5M4J2R423042B	1,131
42	48	30	Y-5M4J2L423048B	Y-5M4J2R423048B	1,179
42	54	30	Y-5M4J2L423054B	Y-5M4J2R423054B	1,224
42	60	30	Y-5M4J2L423060B	Y-5M4J2R423060B	1,274

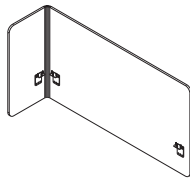

Left Hand

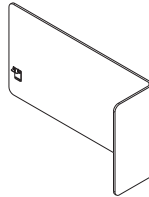

Right Hand

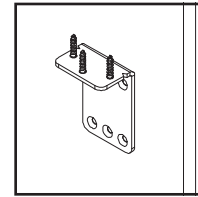

Under Surface Mount Lite

Specify

- Paint Selection for Lite Clip
- Color Selection for PET - Lite Grey, Medium Grey, Tan or Vibrant Blue

Notes

- PET L-Wrap Screens are designed to mount to AIS worksurfaces. Specify based on nominal size for the desired system. Order screens that correspond to worksurface width and depth.
- PET screen inserts are 1/2" (12mm) thick.

PET Day-to-Day, Calibrate & E-Series HAT L-Wrap Partial Modesty Under Surface Mount Lite Screens

Material	Where Used	Screen Type	Sized For	Mount Type	Handedness
PET	L-Wrap Partial Modesty on WS	Lite	L-Wrap for Day-to-Day, Calibrate & E-Series HAT	Under Surface Mount	Left or Right

PET DAY-TO-DAY, CALIBRATE & E-SERIES HAT L-WRAP PARTIAL MODESTY UNDER SURFACE MOUNT LITE SCREENS

H	W	D	Left Hand	Right Hand	List
			Model Number	Model Number	
42	24	36	Y-5M4J2L423624B	Y-5M4J2R423624B	1,037
42	30	36	Y-5M4J2L423630B	Y-5M4J2R423630B	1,086
42	36	36	Y-5M4J2L423636B	Y-5M4J2R423636B	1,131
42	42	36	Y-5M4J2L423642B	Y-5M4J2R423642B	1,179
42	48	36	Y-5M4J2L423648B	Y-5M4J2R423648B	1,224
42	54	36	Y-5M4J2L423654B	Y-5M4J2R423654B	1,274
42	24	42	Y-5M4J2L424224B	Y-5M4J2R424224B	1,086
42	30	42	Y-5M4J2L424230B	Y-5M4J2R424230B	1,131
42	36	42	Y-5M4J2L424236B	Y-5M4J2R424236B	1,179
42	42	42	Y-5M4J2L424242B	Y-5M4J2R424242B	1,224
42	48	42	Y-5M4J2L424248B	Y-5M4J2R424248B	1,274

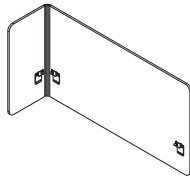

Left Hand

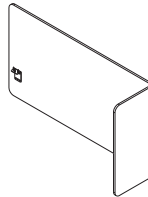

Right Hand

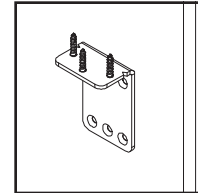

Under Surface Mount Lite

Specify

- Paint Selection for Lite Clip
- Color Selection for PET - Lite Grey, Medium Grey, Tan or Vibrant Blue

Notes

- PET L-Wrap Screens are designed to mount to AIS worksurfaces. Specify based on nominal size for the desired system. Order screens that correspond to worksurface width and depth.
- PET screen inserts are 1/2" (12mm) thick.

PET Day-to-Day, Calibrate & E-Series HAT L-Wrap Partial Modesty Under Surface Mount Lite Screens

Material	Where Used	Screen Type	Sized For	Mount Type	Handedness
PET	L-Wrap Partial Modesty on WS	Lite	L-Wrap for Day-to-Day, Calibrate & E-Series HAT	Under Surface Mount	Left or Right

**PET DAY-TO-DAY, CALIBRATE & E-SERIES HAT
L-WRAP PARTIAL MODESTY UNDER SURFACE MOUNT LITE SCREENS**

H	W	D	Left Hand	Right Hand	List
			Model Number	Model Number	
46	24	12	Y-5M4J2L461224B	Y-5M4J2R461224B	877
46	30	12	Y-5M4J2L461230B	Y-5M4J2R461230B	928
46	36	12	Y-5M4J2L461236B	Y-5M4J2R461236B	981
46	42	12	Y-5M4J2L461242B	Y-5M4J2R461242B	1,031
46	48	12	Y-5M4J2L461248B	Y-5M4J2R461248B	1,085
46	54	12	Y-5M4J2L461254B	Y-5M4J2R461254B	1,133
46	60	12	Y-5M4J2L461260B	Y-5M4J2R461260B	1,186
46	66	12	Y-5M4J2L461266B	Y-5M4J2R461266B	1,237
46	72	12	Y-5M4J2L461272B	Y-5M4J2R461272B	1,289
46	78	12	Y-5M4J2L461278B	Y-5M4J2R461278B	1,341
46	24	18	Y-5M4J2L461824B	Y-5M4J2R461824B	928
46	30	18	Y-5M4J2L461830B	Y-5M4J2R461830B	981
46	36	18	Y-5M4J2L461836B	Y-5M4J2R461836B	1,031
46	42	18	Y-5M4J2L461842B	Y-5M4J2R461842B	1,085
46	48	18	Y-5M4J2L461848B	Y-5M4J2R461848B	1,133
46	54	18	Y-5M4J2L461854B	Y-5M4J2R461854B	1,186
46	60	18	Y-5M4J2L461860B	Y-5M4J2R461860B	1,237
46	66	18	Y-5M4J2L461866B	Y-5M4J2R461866B	1,289
46	72	18	Y-5M4J2L461872B	Y-5M4J2R461872B	1,341

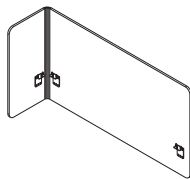

Left Hand

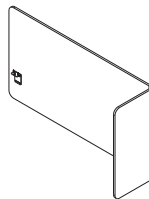

Right Hand

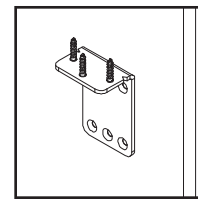

Under Surface Mount Lite

Specify

- Paint Selection for Lite Clip
- Color Selection for PET - Lite Grey, Medium Grey, Tan or Vibrant Blue

Notes

- PET L-Wrap Screens are designed to mount to AIS worksurfaces. Specify based on nominal size for the desired system. Order screens that correspond to worksurface width and depth.
- PET screen inserts are 1/2" (12mm) thick.

PET Day-to-Day, Calibrate & E-Series HAT L-Wrap Partial Modesty Under Surface Mount Lite Screens

Material	Where Used	Screen Type	Sized For	Mount Type	Handedness
PET	L-Wrap Partial Modesty on WS	Lite	L-Wrap for Day-to-Day, Calibrate & E-Series HAT	Under Surface Mount	Left or Right

PET DAY-TO-DAY, CALIBRATE & E-SERIES HAT L-WRAP PARTIAL MODESTY UNDER SURFACE MOUNT LITE SCREENS

H	W	D	Left Hand	Right Hand	List
			Model Number	Model Number	
46	24	24	Y-5M4J2L462424B	Y-5M4J2R462424B	981
46	30	24	Y-5M4J2L462430B	Y-5M4J2R462430B	1,031
46	36	24	Y-5M4J2L462436B	Y-5M4J2R462436B	1,085
46	42	24	Y-5M4J2L462442B	Y-5M4J2R462442B	1,133
46	48	24	Y-5M4J2L462448B	Y-5M4J2R462448B	1,186
46	54	24	Y-5M4J2L462454B	Y-5M4J2R462454B	1,237
46	60	24	Y-5M4J2L462460B	Y-5M4J2R462460B	1,289
46	66	24	Y-5M4J2L462466B	Y-5M4J2R462466B	1,341
46	24	30	Y-5M4J2L463024B	Y-5M4J2R463024B	1,031
46	30	30	Y-5M4J2L463030B	Y-5M4J2R463030B	1,085
46	36	30	Y-5M4J2L463036B	Y-5M4J2R463036B	1,133
46	42	30	Y-5M4J2L463042B	Y-5M4J2R463042B	1,186
46	48	30	Y-5M4J2L463048B	Y-5M4J2R463048B	1,237
46	54	30	Y-5M4J2L463054B	Y-5M4J2R463054B	1,289
46	60	30	Y-5M4J2L463060B	Y-5M4J2R463060B	1,341

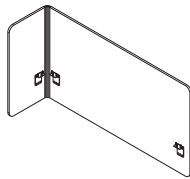

Left Hand

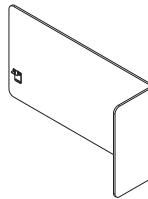

Right Hand

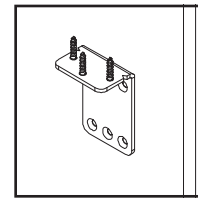

Under Surface Mount Lite

Specify

- Paint Selection for Lite Clip
- Color Selection for PET - Lite Grey, Medium Grey, Tan or Vibrant Blue

Notes

- PET L-Wrap Screens are designed to mount to AIS worksurfaces. Specify based on nominal size for the desired system. Order screens that correspond to worksurface width and depth.
- PET screen inserts are 1/2" (12mm) thick.

PET Day-to-Day, Calibrate & E-Series HAT L-Wrap Partial Modesty Under Surface Mount Lite Screens

Material	Where Used	Screen Type	Sized For	Mount Type	Handedness
PET	L-Wrap Partial Modesty on WS	Lite	L-Wrap for Day-to-Day, Calibrate & E-Series HAT	Under Surface Mount	Left or Right

**PET DAY-TO-DAY, CALIBRATE & E-SERIES HAT
L-WRAP PARTIAL MODESTY UNDER SURFACE MOUNT LITE SCREENS**

H	W	D	Left Hand	Right Hand	List
			Model Number	Model Number	
46	24	36	Y-5M4J2L463624B	Y-5M4J2R463624B	1,085
46	30	36	Y-5M4J2L463630B	Y-5M4J2R463630B	1,133
46	36	36	Y-5M4J2L463636B	Y-5M4J2R463636B	1,186
46	42	36	Y-5M4J2L463642B	Y-5M4J2R463642B	1,237
46	48	36	Y-5M4J2L463648B	Y-5M4J2R463648B	1,289
46	54	36	Y-5M4J2L463654B	Y-5M4J2R463654B	1,341
46	24	42	Y-5M4J2L464224B	Y-5M4J2R464224B	1,133
46	30	42	Y-5M4J2L464230B	Y-5M4J2R464230B	1,186
46	36	42	Y-5M4J2L464236B	Y-5M4J2R464236B	1,237
46	42	42	Y-5M4J2L464242B	Y-5M4J2R464242B	1,289
46	48	42	Y-5M4J2L464248B	Y-5M4J2R464248B	1,341

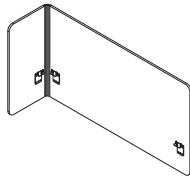

Left Hand

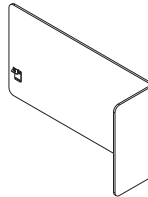

Right Hand

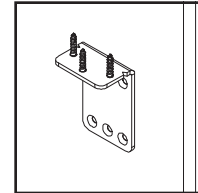

Under Surface Mount Lite

Specify

- Paint Selection for Lite Clip
- Color Selection for PET - Lite Grey, Medium Grey, Tan or Vibrant Blue

Notes

- PET L-Wrap Screens are designed to mount to AIS worksurfaces. Specify based on nominal size for the desired system. Order screens that correspond to worksurface width and depth.
- PET screen inserts are 1/2" (12mm) thick.

L-Wrap Screens Sized for Nominal = Actual Size

PET Nominal = Actual Size L-Wrap Under Surface Mount Lite Screens

Material	Where Used	Screen Type	Sized For	Mount Type	Handedness
PET	L-Wrap on Worksurface	Lite	L-Wrap for Nominal = Actual Size	Under Surface Mount	Left or Right

PET NOMINAL = ACTUAL SIZE L-WRAP UNDER SURFACE MOUNT LITE SCREENS

H	W	D	Left Hand	Right Hand	List
			Model Number	Model Number	
12	24	12	Y-5C4M2L121224B	Y-5C4M2R121224B	627
12	30	12	Y-5C4M2L121230B	Y-5C4M2R121230B	638
12	36	12	Y-5C4M2L121236B	Y-5C4M2R121236B	646
12	42	12	Y-5C4M2L121242B	Y-5C4M2R121242B	656
12	48	12	Y-5C4M2L121248B	Y-5C4M2R121248B	666
12	54	12	Y-5C4M2L121254B	Y-5C4M2R121254B	675
12	60	12	Y-5C4M2L121260B	Y-5C4M2R121260B	684
12	66	12	Y-5C4M2L121266B	Y-5C4M2R121266B	695
12	72	12	Y-5C4M2L121272B	Y-5C4M2R121272B	704
12	78	12	Y-5C4M2L121278B	Y-5C4M2R121278B	713
12	24	18	Y-5C4M2L121824B	Y-5C4M2R121824B	638
12	30	18	Y-5C4M2L121830B	Y-5C4M2R121830B	646
12	36	18	Y-5C4M2L121836B	Y-5C4M2R121836B	656
12	42	18	Y-5C4M2L121842B	Y-5C4M2R121842B	666
12	48	18	Y-5C4M2L121848B	Y-5C4M2R121848B	675
12	54	18	Y-5C4M2L121854B	Y-5C4M2R121854B	684
12	60	18	Y-5C4M2L121860B	Y-5C4M2R121860B	695
12	66	18	Y-5C4M2L121866B	Y-5C4M2R121866B	704
12	72	18	Y-5C4M2L121872B	Y-5C4M2R121872B	713

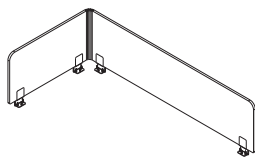

Left Hand

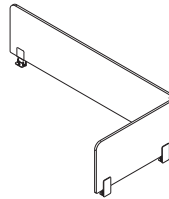

Right Hand

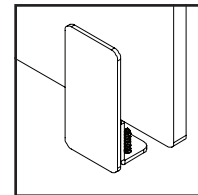

Under Surface Mount Lite

Specify

- Paint Selection for Lite Clip
- Color Selection for PET - Lite Grey, Medium Grey, Tan or Vibrant Blue

Notes

- PET L-Wrap Screens are designed to mount to AIS worksurfaces. Specify based on nominal size for the desired system. Order screens that correspond to worksurface width and depth.
- PET screen inserts are 1/2" (12mm) thick.

PET Nominal = Actual Size L-Wrap Under Surface Mount Lite Screens

Material	Where Used	Screen Type	Sized For	Mount Type	Handedness
PET	L-Wrap on Worksurface	Lite	L-Wrap for Nominal = Actual Size	Under Surface Mount	Left or Right

PET NOMINAL = ACTUAL SIZE L-WRAP UNDER SURFACE MOUNT LITE SCREENS

H	W	D	Left Hand	Right Hand	List
			Model Number	Model Number	
12	24	24	Y-5C4M2L122424B	Y-5C4M2R122424B	646
12	30	24	Y-5C4M2L122430B	Y-5C4M2R122430B	656
12	36	24	Y-5C4M2L122436B	Y-5C4M2R122436B	666
12	42	24	Y-5C4M2L122442B	Y-5C4M2R122442B	675
12	48	24	Y-5C4M2L122448B	Y-5C4M2R122448B	684
12	54	24	Y-5C4M2L122454B	Y-5C4M2R122454B	695
12	60	24	Y-5C4M2L122460B	Y-5C4M2R122460B	704
12	66	24	Y-5C4M2L122466B	Y-5C4M2R122466B	713
12	24	30	Y-5C4M2L123024B	Y-5C4M2R123024B	656
12	30	30	Y-5C4M2L123030B	Y-5C4M2R123030B	666
12	36	30	Y-5C4M2L123036B	Y-5C4M2R123036B	675
12	42	30	Y-5C4M2L123042B	Y-5C4M2R123042B	684
12	48	30	Y-5C4M2L123048B	Y-5C4M2R123048B	695
12	54	30	Y-5C4M2L123054B	Y-5C4M2R123054B	704
12	60	30	Y-5C4M2L123060B	Y-5C4M2R123060B	713

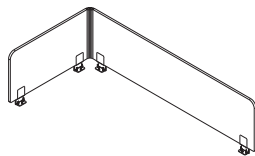

Left Hand

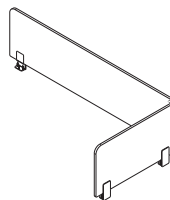

Right Hand

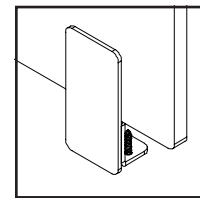

Under Surface Mount Lite

Specify

- Paint Selection for Lite Clip
- Color Selection for PET - Lite Grey, Medium Grey, Tan or Vibrant Blue

Notes

- PET L-Wrap Screens are designed to mount to AIS worksurfaces. Specify based on nominal size for the desired system. Order screens that correspond to worksurface width and depth.
- PET screen inserts are 1/2" (12mm) thick.

PET Nominal = Actual Size L-Wrap Under Surface Mount Lite Screens

Material	Where Used	Screen Type	Sized For	Mount Type	Handedness
PET	L-Wrap on Worksurface	Lite	L-Wrap for Nominal = Actual Size	Under Surface Mount	Left or Right

PET NOMINAL = ACTUAL SIZE L-WRAP UNDER SURFACE MOUNT LITE SCREENS

H	W	D	Left Hand	Right Hand	List
			Model Number	Model Number	
12	24	36	Y-5C4M2L123624B	Y-5C4M2R123624B	666
12	30	36	Y-5C4M2L123630B	Y-5C4M2R123630B	675
12	36	36	Y-5C4M2L123636B	Y-5C4M2R123636B	684
12	42	36	Y-5C4M2L123642B	Y-5C4M2R123642B	695
12	48	36	Y-5C4M2L123648B	Y-5C4M2R123648B	704
12	54	36	Y-5C4M2L123654B	Y-5C4M2R123654B	713
12	24	42	Y-5C4M2L124224B	Y-5C4M2R124224B	675
12	30	42	Y-5C4M2L124230B	Y-5C4M2R124230B	684
12	36	42	Y-5C4M2L124236B	Y-5C4M2R124236B	695
12	42	42	Y-5C4M2L124242B	Y-5C4M2R124242B	704
12	48	42	Y-5C4M2L124248B	Y-5C4M2R124248B	713

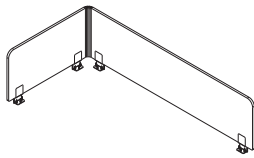

Left Hand

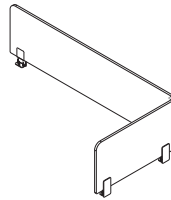

Right Hand

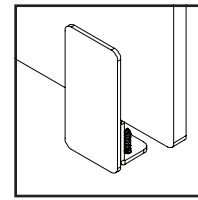

Under Surface Mount Lite

Specify

- Paint Selection for Lite Clip
- Color Selection for PET - Lite Grey, Medium Grey, Tan or Vibrant Blue

Notes

- PET L-Wrap Screens are designed to mount to AIS worksurfaces. Specify based on nominal size for the desired system. Order screens that correspond to worksurface width and depth.
- PET screen inserts are 1/2" (12mm) thick.

PET Nominal = Actual Size L-Wrap Under Surface Mount Lite Screens

Material	Where Used	Screen Type	Sized For	Mount Type	Handedness
PET	L-Wrap on Worksurface	Lite	L-Wrap for Nominal = Actual Size	Under Surface Mount	Left or Right

PET NOMINAL = ACTUAL SIZE L-WRAP UNDER SURFACE MOUNT LITE SCREENS

H	W	D	Left Hand	Right Hand	List
			Model Number	Model Number	
16	24	12	Y-5C4M2L161224B	Y-5C4M2R161224B	646
16	30	12	Y-5C4M2L161230B	Y-5C4M2R161230B	659
16	36	12	Y-5C4M2L161236B	Y-5C4M2R161236B	672
16	42	12	Y-5C4M2L161242B	Y-5C4M2R161242B	684
16	48	12	Y-5C4M2L161248B	Y-5C4M2R161248B	697
16	54	12	Y-5C4M2L161254B	Y-5C4M2R161254B	710
16	60	12	Y-5C4M2L161260B	Y-5C4M2R161260B	724
16	66	12	Y-5C4M2L161266B	Y-5C4M2R161266B	736
16	72	12	Y-5C4M2L161272B	Y-5C4M2R161272B	748
16	78	12	Y-5C4M2L161278B	Y-5C4M2R161278B	761
16	24	18	Y-5C4M2L161824B	Y-5C4M2R161824B	659
16	30	18	Y-5C4M2L161830B	Y-5C4M2R161830B	672
16	36	18	Y-5C4M2L161836B	Y-5C4M2R161836B	684
16	42	18	Y-5C4M2L161842B	Y-5C4M2R161842B	697
16	48	18	Y-5C4M2L161848B	Y-5C4M2R161848B	710
16	54	18	Y-5C4M2L161854B	Y-5C4M2R161854B	724
16	60	18	Y-5C4M2L161860B	Y-5C4M2R161860B	736
16	66	18	Y-5C4M2L161866B	Y-5C4M2R161866B	748
16	72	18	Y-5C4M2L161872B	Y-5C4M2R161872B	761

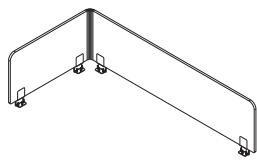

Left Hand

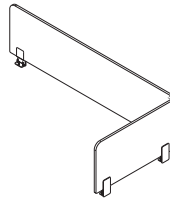

Right Hand

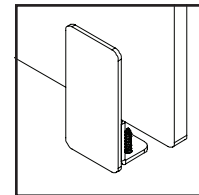

Under Surface Mount Lite

Specify

- Paint Selection for Lite Clip
- Color Selection for PET - Lite Grey, Medium Grey, Tan or Vibrant Blue

Notes

- PET L-Wrap Screens are designed to mount to AIS worksurfaces. Specify based on nominal size for the desired system. Order screens that correspond to worksurface width and depth.
- PET screen inserts are 1/2" (12mm) thick.

PET Nominal = Actual Size L-Wrap Under Surface Mount Lite Screens

Material	Where Used	Screen Type	Sized For	Mount Type	Handedness
PET	L-Wrap on Worksurface	Lite	L-Wrap for Nominal = Actual Size	Under Surface Mount	Left or Right

PET NOMINAL = ACTUAL SIZE L-WRAP UNDER SURFACE MOUNT LITE SCREENS

H	W	D	Left Hand	Right Hand	List
			Model Number	Model Number	
16	24	24	Y-5C4M2L162424B	Y-5C4M2R162424B	672
16	30	24	Y-5C4M2L162430B	Y-5C4M2R162430B	684
16	36	24	Y-5C4M2L162436B	Y-5C4M2R162436B	697
16	42	24	Y-5C4M2L162442B	Y-5C4M2R162442B	710
16	48	24	Y-5C4M2L162448B	Y-5C4M2R162448B	724
16	54	24	Y-5C4M2L162454B	Y-5C4M2R162454B	736
16	60	24	Y-5C4M2L162460B	Y-5C4M2R162460B	748
16	66	24	Y-5C4M2L162466B	Y-5C4M2R162466B	761
16	24	30	Y-5C4M2L163024B	Y-5C4M2R163024B	684
16	30	30	Y-5C4M2L163030B	Y-5C4M2R163030B	697
16	36	30	Y-5C4M2L163036B	Y-5C4M2R163036B	710
16	42	30	Y-5C4M2L163042B	Y-5C4M2R163042B	724
16	48	30	Y-5C4M2L163048B	Y-5C4M2R163048B	736
16	54	30	Y-5C4M2L163054B	Y-5C4M2R163054B	748
16	60	30	Y-5C4M2L163060B	Y-5C4M2R163060B	761

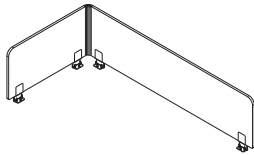

Left Hand

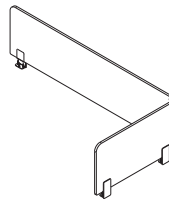

Right Hand

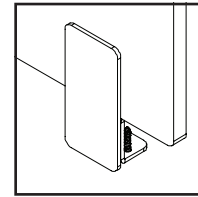

Under Surface Mount Lite

Specify

- Paint Selection for Lite Clip
- Color Selection for PET - Lite Grey, Medium Grey, Tan or Vibrant Blue

Notes

- PET L-Wrap Screens are designed to mount to AIS worksurfaces. Specify based on nominal size for the desired system. Order screens that correspond to worksurface width and depth.
- PET screen inserts are 1/2" (12mm) thick.

PET Nominal = Actual Size L-Wrap Under Surface Mount Lite Screens

Material	Where Used	Screen Type	Sized For	Mount Type	Handedness
PET	L-Wrap on Worksurface	Lite	L-Wrap for Nominal = Actual Size	Under Surface Mount	Left or Right

PET NOMINAL = ACTUAL SIZE L-WRAP UNDER SURFACE MOUNT LITE SCREENS

H	W	D	Left Hand	Right Hand	List
			Model Number	Model Number	
16	24	36	Y-5C4M2L163624B	Y-5C4M2R163624B	697
16	30	36	Y-5C4M2L163630B	Y-5C4M2R163630B	710
16	36	36	Y-5C4M2L163636B	Y-5C4M2R163636B	724
16	42	36	Y-5C4M2L163642B	Y-5C4M2R163642B	736
16	48	36	Y-5C4M2L163648B	Y-5C4M2R163648B	748
16	54	36	Y-5C4M2L163654B	Y-5C4M2R163654B	761
16	24	42	Y-5C4M2L164224B	Y-5C4M2R164224B	710
16	30	42	Y-5C4M2L164230B	Y-5C4M2R164230B	724
16	36	42	Y-5C4M2L164236B	Y-5C4M2R164236B	736
16	42	42	Y-5C4M2L164242B	Y-5C4M2R164242B	748
16	48	42	Y-5C4M2L164248B	Y-5C4M2R164248B	761

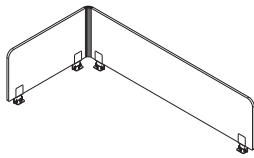

Left Hand

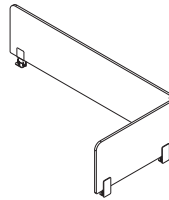

Right Hand

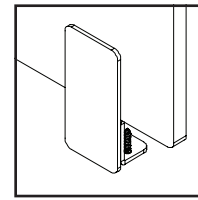

Under Surface Mount Lite

Specify

- Paint Selection for Lite Clip
- Color Selection for PET - Lite Grey, Medium Grey, Tan or Vibrant Blue

Notes

- PET L-Wrap Screens are designed to mount to AIS worksurfaces. Specify based on nominal size for the desired system. Order screens that correspond to worksurface width and depth.
- PET screen inserts are 1/2" (12mm) thick.

PET Nominal = Actual Size L-Wrap Under Surface Mount Lite Screens

Material	Where Used	Screen Type	Sized For	Mount Type	Handedness
PET	L-Wrap on Worksurface	Lite	L-Wrap for Nominal = Actual Size	Under Surface Mount	Left or Right

PET NOMINAL = ACTUAL SIZE L-WRAP UNDER SURFACE MOUNT LITE SCREENS

H	W	D	Left Hand	Right Hand	List
			Model Number	Model Number	
20	24	12	Y-5C4M2L201224B	Y-5C4M2R201224B	666
20	30	12	Y-5C4M2L201230B	Y-5C4M2R201230B	682
20	36	12	Y-5C4M2L201236B	Y-5C4M2R201236B	697
20	42	12	Y-5C4M2L201242B	Y-5C4M2R201242B	713
20	48	12	Y-5C4M2L201248B	Y-5C4M2R201248B	729
20	54	12	Y-5C4M2L201254B	Y-5C4M2R201254B	746
20	60	12	Y-5C4M2L201260B	Y-5C4M2R201260B	761
20	66	12	Y-5C4M2L201266B	Y-5C4M2R201266B	776
20	72	12	Y-5C4M2L201272B	Y-5C4M2R201272B	794
20	78	12	Y-5C4M2L201278B	Y-5C4M2R201278B	808
20	24	18	Y-5C4M2L201824B	Y-5C4M2R201824B	682
20	30	18	Y-5C4M2L201830B	Y-5C4M2R201830B	697
20	36	18	Y-5C4M2L201836B	Y-5C4M2R201836B	713
20	42	18	Y-5C4M2L201842B	Y-5C4M2R201842B	729
20	48	18	Y-5C4M2L201848B	Y-5C4M2R201848B	746
20	54	18	Y-5C4M2L201854B	Y-5C4M2R201854B	761
20	60	18	Y-5C4M2L201860B	Y-5C4M2R201860B	776
20	66	18	Y-5C4M2L201866B	Y-5C4M2R201866B	794
20	72	18	Y-5C4M2L201872B	Y-5C4M2R201872B	808

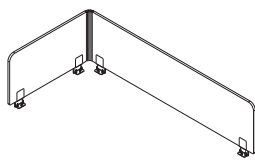

Left Hand

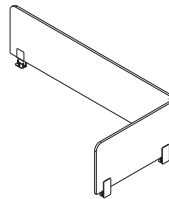

Right Hand

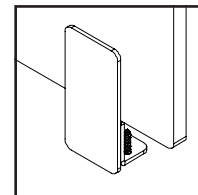

Under Surface Mount Lite

Specify

- Paint Selection for Lite Clip
- Color Selection for PET - Lite Grey, Medium Grey, Tan or Vibrant Blue

Notes

- PET L-Wrap Screens are designed to mount to AIS worksurfaces. Specify based on nominal size for the desired system. Order screens that correspond to worksurface width and depth.
- PET screen inserts are 1/2" (12mm) thick.

PET Nominal = Actual Size L-Wrap Under Surface Mount Lite Screens

Material	Where Used	Screen Type	Sized For	Mount Type	Handedness
PET	L-Wrap on Worksurface	Lite	L-Wrap for Nominal = Actual Size	Under Surface Mount	Left or Right

PET NOMINAL = ACTUAL SIZE L-WRAP UNDER SURFACE MOUNT LITE SCREENS

H	W	D	Left Hand	Right Hand	List
			Model Number	Model Number	
20	24	24	Y-5C4M2L202424B	Y-5C4M2R202424B	697
20	30	24	Y-5C4M2L202430B	Y-5C4M2R202430B	713
20	36	24	Y-5C4M2L202436B	Y-5C4M2R202436B	729
20	42	24	Y-5C4M2L202442B	Y-5C4M2R202442B	746
20	48	24	Y-5C4M2L202448B	Y-5C4M2R202448B	761
20	54	24	Y-5C4M2L202454B	Y-5C4M2R202454B	776
20	60	24	Y-5C4M2L202460B	Y-5C4M2R202460B	794
20	66	24	Y-5C4M2L202466B	Y-5C4M2R202466B	808
20	24	30	Y-5C4M2L203024B	Y-5C4M2R203024B	713
20	30	30	Y-5C4M2L203030B	Y-5C4M2R203030B	729
20	36	30	Y-5C4M2L203036B	Y-5C4M2R203036B	746
20	42	30	Y-5C4M2L203042B	Y-5C4M2R203042B	761
20	48	30	Y-5C4M2L203048B	Y-5C4M2R203048B	776
20	54	30	Y-5C4M2L203054B	Y-5C4M2R203054B	794
20	60	30	Y-5C4M2L203060B	Y-5C4M2R203060B	808

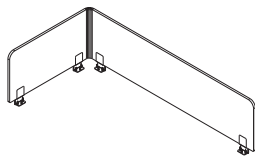

Left Hand

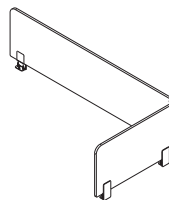

Right Hand

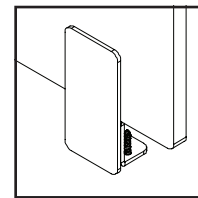

Under Surface Mount Lite

Specify

- Paint Selection for Lite Clip
- Color Selection for PET - Lite Grey, Medium Grey, Tan or Vibrant Blue

Notes

- PET L-Wrap Screens are designed to mount to AIS worksurfaces. Specify based on nominal size for the desired system. Order screens that correspond to worksurface width and depth.
- PET screen inserts are 1/2" (12mm) thick.

PET Nominal = Actual Size L-Wrap Under Surface Mount Lite Screens

Material	Where Used	Screen Type	Sized For	Mount Type	Handedness
PET	L-Wrap on Worksurface	Lite	L-Wrap for Nominal = Actual Size	Under Surface Mount	Left or Right

PET NOMINAL = ACTUAL SIZE L-WRAP UNDER SURFACE MOUNT LITE SCREENS

H	W	D	Left Hand	Right Hand	List
			Model Number	Model Number	
20	24	36	Y-5C4M2L203624B	Y-5C4M2R203624B	729
20	30	36	Y-5C4M2L203630B	Y-5C4M2R203630B	746
20	36	36	Y-5C4M2L203636B	Y-5C4M2R203636B	761
20	42	36	Y-5C4M2L203642B	Y-5C4M2R203642B	776
20	48	36	Y-5C4M2L203648B	Y-5C4M2R203648B	794
20	54	36	Y-5C4M2L203654B	Y-5C4M2R203654B	808
20	24	42	Y-5C4M2L204224B	Y-5C4M2R204224B	746
20	30	42	Y-5C4M2L204230B	Y-5C4M2R204230B	761
20	36	42	Y-5C4M2L204236B	Y-5C4M2R204236B	776
20	42	42	Y-5C4M2L204242B	Y-5C4M2R204242B	794
20	48	42	Y-5C4M2L204248B	Y-5C4M2R204248B	808

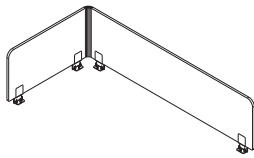

Left Hand

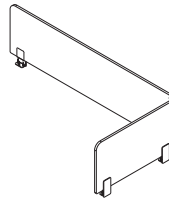

Right Hand

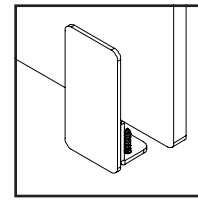

Under Surface Mount Lite

Specify

- Paint Selection for Lite Clip
- Color Selection for PET - Lite Grey, Medium Grey, Tan or Vibrant Blue

Notes

- PET L-Wrap Screens are designed to mount to AIS worksurfaces. Specify based on nominal size for the desired system. Order screens that correspond to worksurface width and depth.
- PET screen inserts are 1/2" (12mm) thick.

PET Nominal = Actual Size L-Wrap Under Surface Mount Lite Screens

Material	Where Used	Screen Type	Sized For	Mount Type	Handedness
PET	L-Wrap on Worksurface	Lite	L-Wrap for Nominal = Actual Size	Under Surface Mount	Left or Right

PET NOMINAL = ACTUAL SIZE L-WRAP UNDER SURFACE MOUNT LITE SCREENS

H	W	D	Left Hand	Right Hand	List
			Model Number	Model Number	
24	24	12	Y-5C4M2L241224B	Y-5C4M2R241224B	684
24	30	12	Y-5C4M2L241230B	Y-5C4M2R241230B	704
24	36	12	Y-5C4M2L241236B	Y-5C4M2R241236B	724
24	42	12	Y-5C4M2L241242B	Y-5C4M2R241242B	740
24	48	12	Y-5C4M2L241248B	Y-5C4M2R241248B	761
24	54	12	Y-5C4M2L241254B	Y-5C4M2R241254B	779
24	60	12	Y-5C4M2L241260B	Y-5C4M2R241260B	800
24	66	12	Y-5C4M2L241266B	Y-5C4M2R241266B	818
24	72	12	Y-5C4M2L241272B	Y-5C4M2R241272B	837
24	78	12	Y-5C4M2L241278B	Y-5C4M2R241278B	858
24	24	18	Y-5C4M2L241824B	Y-5C4M2R241824B	704
24	30	18	Y-5C4M2L241830B	Y-5C4M2R241830B	724
24	36	18	Y-5C4M2L241836B	Y-5C4M2R241836B	740
24	42	18	Y-5C4M2L241842B	Y-5C4M2R241842B	761
24	48	18	Y-5C4M2L241848B	Y-5C4M2R241848B	779
24	54	18	Y-5C4M2L241854B	Y-5C4M2R241854B	800
24	60	18	Y-5C4M2L241860B	Y-5C4M2R241860B	818
24	66	18	Y-5C4M2L241866B	Y-5C4M2R241866B	837
24	72	18	Y-5C4M2L241872B	Y-5C4M2R241872B	858

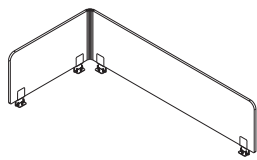

Left Hand

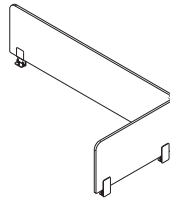

Right Hand

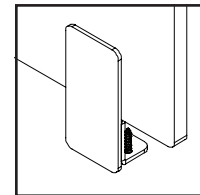

Under Surface Mount Lite

Specify

- Paint Selection for Lite Clip
- Color Selection for PET - Lite Grey, Medium Grey, Tan or Vibrant Blue

Notes

- PET L-Wrap Screens are designed to mount to AIS worksurfaces. Specify based on nominal size for the desired system. Order screens that correspond to worksurface width and depth.
- PET screen inserts are 1/2" (12mm) thick.

PET Nominal = Actual Size L-Wrap Under Surface Mount Lite Screens

Material	Where Used	Screen Type	Sized For	Mount Type	Handedness
PET	L-Wrap on Worksurface	Lite	L-Wrap for Nominal = Actual Size	Under Surface Mount	Left or Right

PET NOMINAL = ACTUAL SIZE L-WRAP UNDER SURFACE MOUNT LITE SCREENS

H	W	D	Left Hand	Right Hand	List
			Model Number	Model Number	
24	24	24	Y-5C4M2L242424B	Y-5C4M2R242424B	724
24	30	24	Y-5C4M2L242430B	Y-5C4M2R242430B	740
24	36	24	Y-5C4M2L242436B	Y-5C4M2R242436B	761
24	42	24	Y-5C4M2L242442B	Y-5C4M2R242442B	779
24	48	24	Y-5C4M2L242448B	Y-5C4M2R242448B	800
24	54	24	Y-5C4M2L242454B	Y-5C4M2R242454B	818
24	60	24	Y-5C4M2L242460B	Y-5C4M2R242460B	837
24	66	24	Y-5C4M2L242466B	Y-5C4M2R242466B	858
24	24	30	Y-5C4M2L243024B	Y-5C4M2R243024B	740
24	30	30	Y-5C4M2L243030B	Y-5C4M2R243030B	761
24	36	30	Y-5C4M2L243036B	Y-5C4M2R243036B	779
24	42	30	Y-5C4M2L243042B	Y-5C4M2R243042B	800
24	48	30	Y-5C4M2L243048B	Y-5C4M2R243048B	818
24	54	30	Y-5C4M2L243054B	Y-5C4M2R243054B	837
24	60	30	Y-5C4M2L243060B	Y-5C4M2R243060B	858

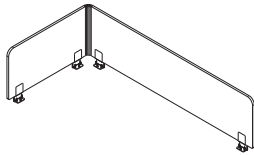

Left Hand

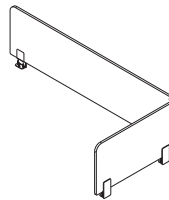

Right Hand

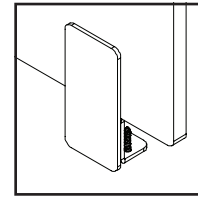

Under Surface Mount Lite

Specify

- Paint Selection for Lite Clip
- Color Selection for PET - Lite Grey, Medium Grey, Tan or Vibrant Blue

Notes

- PET L-Wrap Screens are designed to mount to AIS worksurfaces. Specify based on nominal size for the desired system. Order screens that correspond to worksurface width and depth.
- PET screen inserts are 1/2" (12mm) thick.

PET Nominal = Actual Size L-Wrap Under Surface Mount Lite Screens

Material	Where Used	Screen Type	Sized For	Mount Type	Handedness
PET	L-Wrap on Worksurface	Lite	L-Wrap for Nominal = Actual Size	Under Surface Mount	Left or Right

PET NOMINAL = ACTUAL SIZE L-WRAP UNDER SURFACE MOUNT LITE SCREENS

H	W	D	Left Hand	Right Hand	List
			Model Number	Model Number	
24	24	36	Y-5C4M2L243624B	Y-5C4M2R243624B	761
24	30	36	Y-5C4M2L243630B	Y-5C4M2R243630B	779
24	36	36	Y-5C4M2L243636B	Y-5C4M2R243636B	800
24	42	36	Y-5C4M2L243642B	Y-5C4M2R243642B	818
24	48	36	Y-5C4M2L243648B	Y-5C4M2R243648B	837
24	54	36	Y-5C4M2L243654B	Y-5C4M2R243654B	858
24	24	42	Y-5C4M2L244224B	Y-5C4M2R244224B	779
24	30	42	Y-5C4M2L244230B	Y-5C4M2R244230B	800
24	36	42	Y-5C4M2L244236B	Y-5C4M2R244236B	818
24	42	42	Y-5C4M2L244242B	Y-5C4M2R244242B	837
24	48	42	Y-5C4M2L244248B	Y-5C4M2R244248B	858

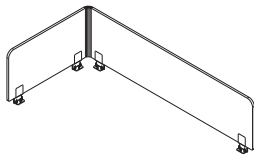

Left Hand

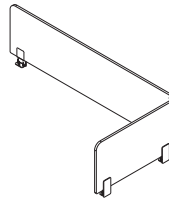

Right Hand

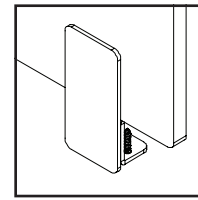

Under Surface Mount Lite

Specify

- Paint Selection for Lite Clip
- Color Selection for PET - Lite Grey, Medium Grey, Tan or Vibrant Blue

Notes

- PET L-Wrap Screens are designed to mount to AIS worksurfaces. Specify based on nominal size for the desired system. Order screens that correspond to worksurface width and depth.
- PET screen inserts are 1/2" (12mm) thick.

PET Nominal = Actual Size L-Wrap Under Surface Mount Lite Screens

Material	Where Used	Screen Type	Sized For	Mount Type	Handedness
PET	L-Wrap on Worksurface	Lite	L-Wrap for Nominal = Actual Size	Under Surface Mount	Left or Right

PET NOMINAL = ACTUAL SIZE L-WRAP UNDER SURFACE MOUNT LITE SCREENS

H	W	D	Left Hand	Right Hand	List
			Model Number	Model Number	
28	24	12	Y-5C4M2L281224B	Y-5C4M2R281224B	704
28	30	12	Y-5C4M2L281230B	Y-5C4M2R281230B	726
28	36	12	Y-5C4M2L281236B	Y-5C4M2R281236B	748
28	42	12	Y-5C4M2L281242B	Y-5C4M2R281242B	769
28	48	12	Y-5C4M2L281248B	Y-5C4M2R281248B	794
28	54	12	Y-5C4M2L281254B	Y-5C4M2R281254B	815
28	60	12	Y-5C4M2L281260B	Y-5C4M2R281260B	837
28	66	12	Y-5C4M2L281266B	Y-5C4M2R281266B	860
28	72	12	Y-5C4M2L281272B	Y-5C4M2R281272B	881
28	78	12	Y-5C4M2L281278B	Y-5C4M2R281278B	904
28	24	18	Y-5C4M2L281824B	Y-5C4M2R281824B	726
28	30	18	Y-5C4M2L281830B	Y-5C4M2R281830B	748
28	36	18	Y-5C4M2L281836B	Y-5C4M2R281836B	769
28	42	18	Y-5C4M2L281842B	Y-5C4M2R281842B	794
28	48	18	Y-5C4M2L281848B	Y-5C4M2R281848B	815
28	54	18	Y-5C4M2L281854B	Y-5C4M2R281854B	837
28	60	18	Y-5C4M2L281860B	Y-5C4M2R281860B	860
28	66	18	Y-5C4M2L281866B	Y-5C4M2R281866B	881
28	72	18	Y-5C4M2L281872B	Y-5C4M2R281872B	904

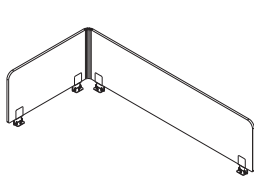

Left Hand

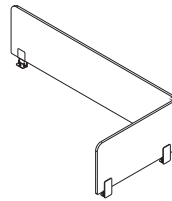

Right Hand

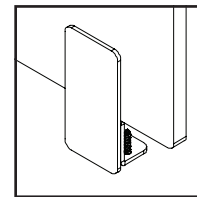

Under Surface Mount Lite

Specify

- Paint Selection for Lite Clip
- Color Selection for PET - Lite Grey, Medium Grey, Tan or Vibrant Blue

Notes

- PET L-Wrap Screens are designed to mount to AIS worksurfaces. Specify based on nominal size for the desired system. Order screens that correspond to worksurface width and depth.
- PET screen inserts are 1/2" (12mm) thick.

PET Nominal = Actual Size L-Wrap Under Surface Mount Lite Screens

Material	Where Used	Screen Type	Sized For	Mount Type	Handedness
PET	L-Wrap on Worksurface	Lite	L-Wrap for Nominal = Actual Size	Under Surface Mount	Left or Right

PET NOMINAL = ACTUAL SIZE L-WRAP UNDER SURFACE MOUNT LITE SCREENS

H	W	D	Left Hand	Right Hand	List
			Model Number	Model Number	
28	24	24	Y-5C4M2L282424B	Y-5C4M2R282424B	748
28	30	24	Y-5C4M2L282430B	Y-5C4M2R282430B	769
28	36	24	Y-5C4M2L282436B	Y-5C4M2R282436B	794
28	42	24	Y-5C4M2L282442B	Y-5C4M2R282442B	815
28	48	24	Y-5C4M2L282448B	Y-5C4M2R282448B	837
28	54	24	Y-5C4M2L282454B	Y-5C4M2R282454B	860
28	60	24	Y-5C4M2L282460B	Y-5C4M2R282460B	881
28	66	24	Y-5C4M2L282466B	Y-5C4M2R282466B	904
28	24	30	Y-5C4M2L283024B	Y-5C4M2R283024B	769
28	30	30	Y-5C4M2L283030B	Y-5C4M2R283030B	794
28	36	30	Y-5C4M2L283036B	Y-5C4M2R283036B	815
28	42	30	Y-5C4M2L283042B	Y-5C4M2R283042B	837
28	48	30	Y-5C4M2L283048B	Y-5C4M2R283048B	860
28	54	30	Y-5C4M2L283054B	Y-5C4M2R283054B	881
28	60	30	Y-5C4M2L283060B	Y-5C4M2R283060B	904

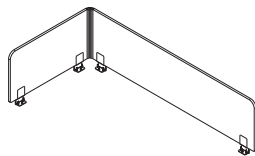

Left Hand

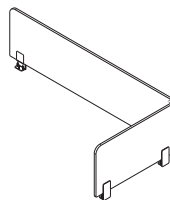

Right Hand

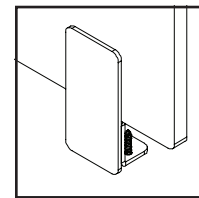

Under Surface Mount Lite

Specify

- Paint Selection for Lite Clip
- Color Selection for PET - Lite Grey, Medium Grey, Tan or Vibrant Blue

Notes

- PET L-Wrap Screens are designed to mount to AIS worksurfaces. Specify based on nominal size for the desired system. Order screens that correspond to worksurface width and depth.
- PET screen inserts are 1/2" (12mm) thick.

PET Nominal = Actual Size L-Wrap Under Surface Mount Lite Screens

Material	Where Used	Screen Type	Sized For	Mount Type	Handedness
PET	L-Wrap on Worksurface	Lite	L-Wrap for Nominal = Actual Size	Under Surface Mount	Left or Right

PET NOMINAL = ACTUAL SIZE L-WRAP UNDER SURFACE MOUNT LITE SCREENS

H	W	D	Left Hand	Right Hand	List
			Model Number	Model Number	
28	24	36	Y-5C4M2L283624B	Y-5C4M2R283624B	794
28	30	36	Y-5C4M2L283630B	Y-5C4M2R283630B	815
28	36	36	Y-5C4M2L283636B	Y-5C4M2R283636B	837
28	42	36	Y-5C4M2L283642B	Y-5C4M2R283642B	860
28	48	36	Y-5C4M2L283648B	Y-5C4M2R283648B	881
28	54	36	Y-5C4M2L283654B	Y-5C4M2R283654B	904
28	24	42	Y-5C4M2L284224B	Y-5C4M2R284224B	815
28	30	42	Y-5C4M2L284230B	Y-5C4M2R284230B	837
28	36	42	Y-5C4M2L284236B	Y-5C4M2R284236B	860
28	42	42	Y-5C4M2L284242B	Y-5C4M2R284242B	881
28	48	42	Y-5C4M2L284248B	Y-5C4M2R284248B	904

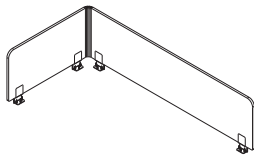

Left Hand

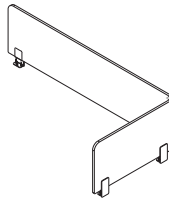

Right Hand

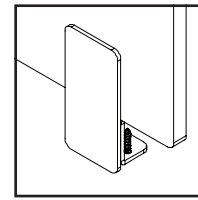

Under Surface Mount Lite

Specify

- Paint Selection for Lite Clip
- Color Selection for PET - Lite Grey, Medium Grey, Tan or Vibrant Blue

Notes

- PET L-Wrap Screens are designed to mount to AIS worksurfaces. Specify based on nominal size for the desired system. Order screens that correspond to worksurface width and depth.
- PET screen inserts are 1/2" (12mm) thick.

PET Nominal = Actual Size L-Wrap Under Surface Mount Lite Screens

Material	Where Used	Screen Type	Sized For	Mount Type	Handedness
PET	L-Wrap on Worksurface	Lite	L-Wrap for Nominal = Actual Size	Under Surface Mount	Left or Right

PET NOMINAL = ACTUAL SIZE L-WRAP UNDER SURFACE MOUNT LITE SCREENS

H	W	D	Left Hand	Right Hand	List
			Model Number	Model Number	
32	24	12	Y-5C4M2L321224B	Y-5C4M2R321224B	786
32	30	12	Y-5C4M2L321230B	Y-5C4M2R321230B	820
32	36	12	Y-5C4M2L321236B	Y-5C4M2R321236B	856
32	42	12	Y-5C4M2L321242B	Y-5C4M2R321242B	890
32	48	12	Y-5C4M2L321248B	Y-5C4M2R321248B	927
32	54	12	Y-5C4M2L321254B	Y-5C4M2R321254B	962
32	60	12	Y-5C4M2L321260B	Y-5C4M2R321260B	997
32	66	12	Y-5C4M2L321266B	Y-5C4M2R321266B	1,033
32	72	12	Y-5C4M2L321272B	Y-5C4M2R321272B	1,069
32	78	12	Y-5C4M2L321278B	Y-5C4M2R321278B	1,105
32	24	18	Y-5C4M2L321824B	Y-5C4M2R321824B	820
32	30	18	Y-5C4M2L321830B	Y-5C4M2R321830B	856
32	36	18	Y-5C4M2L321836B	Y-5C4M2R321836B	890
32	42	18	Y-5C4M2L321842B	Y-5C4M2R321842B	927
32	48	18	Y-5C4M2L321848B	Y-5C4M2R321848B	962
32	54	18	Y-5C4M2L321854B	Y-5C4M2R321854B	997
32	60	18	Y-5C4M2L321860B	Y-5C4M2R321860B	1,033
32	66	18	Y-5C4M2L321866B	Y-5C4M2R321866B	1,069
32	72	18	Y-5C4M2L321872B	Y-5C4M2R321872B	1,105

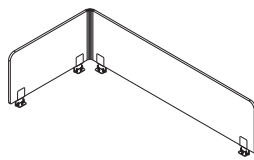

Left Hand

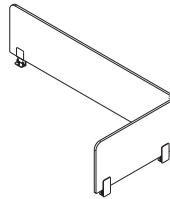

Right Hand

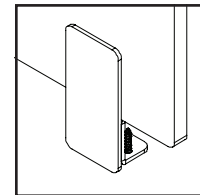

Under Surface Mount Lite

Specify

- Paint Selection for Lite Clip
- Color Selection for PET - Lite Grey, Medium Grey, Tan or Vibrant Blue

Notes

- PET L-Wrap Screens are designed to mount to AIS worksurfaces. Specify based on nominal size for the desired system. Order screens that correspond to worksurface width and depth.
- PET screen inserts are 1/2" (12mm) thick.

PET Nominal = Actual Size L-Wrap Under Surface Mount Lite Screens

Material	Where Used	Screen Type	Sized For	Mount Type	Handedness
PET	L-Wrap on Worksurface	Lite	L-Wrap for Nominal = Actual Size	Under Surface Mount	Left or Right

PET NOMINAL = ACTUAL SIZE L-WRAP UNDER SURFACE MOUNT LITE SCREENS

H	W	D	Left Hand	Right Hand	List
			Model Number	Model Number	
32	24	24	Y-5C4M2L322424B	Y-5C4M2R322424B	856
32	30	24	Y-5C4M2L322430B	Y-5C4M2R322430B	890
32	36	24	Y-5C4M2L322436B	Y-5C4M2R322436B	927
32	42	24	Y-5C4M2L322442B	Y-5C4M2R322442B	962
32	48	24	Y-5C4M2L322448B	Y-5C4M2R322448B	997
32	54	24	Y-5C4M2L322454B	Y-5C4M2R322454B	1,033
32	60	24	Y-5C4M2L322460B	Y-5C4M2R322460B	1,069
32	66	24	Y-5C4M2L322466B	Y-5C4M2R322466B	1,105
32	24	30	Y-5C4M2L323024B	Y-5C4M2R323024B	890
32	30	30	Y-5C4M2L323030B	Y-5C4M2R323030B	927
32	36	30	Y-5C4M2L323036B	Y-5C4M2R323036B	962
32	42	30	Y-5C4M2L323042B	Y-5C4M2R323042B	997
32	48	30	Y-5C4M2L323048B	Y-5C4M2R323048B	1,033
32	54	30	Y-5C4M2L323054B	Y-5C4M2R323054B	1,069
32	60	30	Y-5C4M2L323060B	Y-5C4M2R323060B	1,105

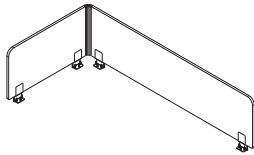

Left Hand

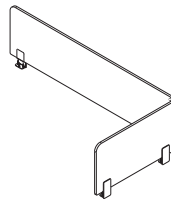

Right Hand

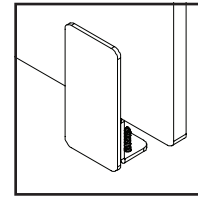

Under Surface Mount Lite

Specify

- Paint Selection for Lite Clip
- Color Selection for PET - Lite Grey, Medium Grey, Tan or Vibrant Blue

Notes

- PET L-Wrap Screens are designed to mount to AIS worksurfaces. Specify based on nominal size for the desired system. Order screens that correspond to worksurface width and depth.
- PET screen inserts are 1/2" (12mm) thick.

PET Nominal = Actual Size L-Wrap Under Surface Mount Lite Screens

Material	Where Used	Screen Type	Sized For	Mount Type	Handedness
PET	L-Wrap on Worksurface	Lite	L-Wrap for Nominal = Actual Size	Under Surface Mount	Left or Right

PET NOMINAL = ACTUAL SIZE L-WRAP UNDER SURFACE MOUNT LITE SCREENS

H	W	D	Left Hand	Right Hand	List
			Model Number	Model Number	
32	24	36	Y-5C4M2L323624B	Y-5C4M2R323624B	927
32	30	36	Y-5C4M2L323630B	Y-5C4M2R323630B	962
32	36	36	Y-5C4M2L323636B	Y-5C4M2R323636B	997
32	42	36	Y-5C4M2L323642B	Y-5C4M2R323642B	1,033
32	48	36	Y-5C4M2L323648B	Y-5C4M2R323648B	1,069
32	54	36	Y-5C4M2L323654B	Y-5C4M2R323654B	1,105
32	24	42	Y-5C4M2L324224B	Y-5C4M2R324224B	962
32	30	42	Y-5C4M2L324230B	Y-5C4M2R324230B	997
32	36	42	Y-5C4M2L324236B	Y-5C4M2R324236B	1,033
32	42	42	Y-5C4M2L324242B	Y-5C4M2R324242B	1,069
32	48	42	Y-5C4M2L324248B	Y-5C4M2R324248B	1,105

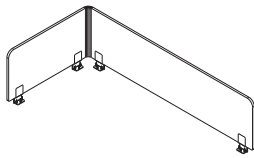

Left Hand

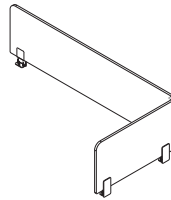

Right Hand

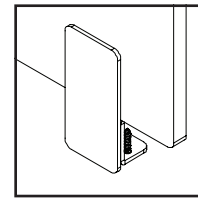

Under Surface Mount Lite

Specify

- Paint Selection for Lite Clip
- Color Selection for PET - Lite Grey, Medium Grey, Tan or Vibrant Blue

Notes

- PET L-Wrap Screens are designed to mount to AIS worksurfaces. Specify based on nominal size for the desired system. Order screens that correspond to worksurface width and depth.
- PET screen inserts are 1/2" (12mm) thick.

PET Nominal = Actual Size L-Wrap Partial Modesty Under Surface Mount Lite Screens

Material	Where Used	Screen Type	Sized For	Mount Type	Handedness
PET	L-Wrap Partial Modesty on WS	Lite	L-Wrap for Nominal = Actual Size	Under Surface Mount	Left or Right

PET NOMINAL = ACTUAL SIZE L-WRAP PARTIAL MODESTY UNDER SURFACE MOUNT LITE SCREENS

H	W	D	Left Hand	Right Hand	List
			Model Number	Model Number	
22	24	12	Y-5M4M2L221224B	Y-5M4M2R221224B	675
22	30	12	Y-5M4M2L221230B	Y-5M4M2R221230B	693
22	36	12	Y-5M4M2L221236B	Y-5M4M2R221236B	710
22	42	12	Y-5M4M2L221242B	Y-5M4M2R221242B	727
22	48	12	Y-5M4M2L221248B	Y-5M4M2R221248B	746
22	54	12	Y-5M4M2L221254B	Y-5M4M2R221254B	763
22	60	12	Y-5M4M2L221260B	Y-5M4M2R221260B	779
22	66	12	Y-5M4M2L221266B	Y-5M4M2R221266B	798
22	72	12	Y-5M4M2L221272B	Y-5M4M2R221272B	815
22	78	12	Y-5M4M2L221278B	Y-5M4M2R221278B	833
22	24	18	Y-5M4M2L221824B	Y-5M4M2R221824B	693
22	30	18	Y-5M4M2L221830B	Y-5M4M2R221830B	710
22	36	18	Y-5M4M2L221836B	Y-5M4M2R221836B	727
22	42	18	Y-5M4M2L221842B	Y-5M4M2R221842B	746
22	48	18	Y-5M4M2L221848B	Y-5M4M2R221848B	763
22	54	18	Y-5M4M2L221854B	Y-5M4M2R221854B	779
22	60	18	Y-5M4M2L221860B	Y-5M4M2R221860B	798
22	66	18	Y-5M4M2L221866B	Y-5M4M2R221866B	815
22	72	18	Y-5M4M2L221872B	Y-5M4M2R221872B	833

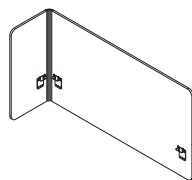

Left Hand

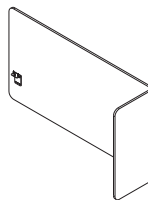

Right Hand

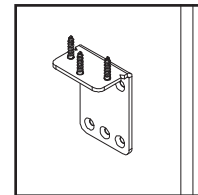

Under Surface Mount Lite

Specify

- Paint Selection for Lite Clip
- Color Selection for PET - Lite Grey, Medium Grey, Tan or Vibrant Blue

Notes

- PET L-Wrap Screens are designed to mount to AIS worksurfaces. Specify based on nominal size for the desired system. Order screens that correspond to worksurface width and depth.
- PET screen inserts are 1/2" (12mm) thick.

PET Nominal = Actual Size L-Wrap Partial Modesty Under Surface Mount Lite Screens

Material	Where Used	Screen Type	Sized For	Mount Type	Handedness
PET	L-Wrap Partial Modesty on WS	Lite	L-Wrap for Nominal = Actual Size	Under Surface Mount	Left or Right

PET NOMINAL = ACTUAL SIZE L-WRAP PARTIAL MODESTY UNDER SURFACE MOUNT LITE SCREENS

H	W	D	Left Hand	Right Hand	List
			Model Number	Model Number	
22	24	24	Y-5M4M2L222424B	Y-5M4M2R222424B	710
22	30	24	Y-5M4M2L222430B	Y-5M4M2R222430B	727
22	36	24	Y-5M4M2L222436B	Y-5M4M2R222436B	746
22	42	24	Y-5M4M2L222442B	Y-5M4M2R222442B	763
22	48	24	Y-5M4M2L222448B	Y-5M4M2R222448B	779
22	54	24	Y-5M4M2L222454B	Y-5M4M2R222454B	798
22	60	24	Y-5M4M2L222460B	Y-5M4M2R222460B	815
22	66	24	Y-5M4M2L222466B	Y-5M4M2R222466B	833
22	24	30	Y-5M4M2L223024B	Y-5M4M2R223024B	727
22	30	30	Y-5M4M2L223030B	Y-5M4M2R223030B	746
22	36	30	Y-5M4M2L223036B	Y-5M4M2R223036B	763
22	42	30	Y-5M4M2L223042B	Y-5M4M2R223042B	779
22	48	30	Y-5M4M2L223048B	Y-5M4M2R223048B	798
22	54	30	Y-5M4M2L223054B	Y-5M4M2R223054B	815
22	60	30	Y-5M4M2L223060B	Y-5M4M2R223060B	833

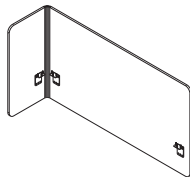

Left Hand

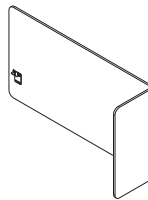

Right Hand

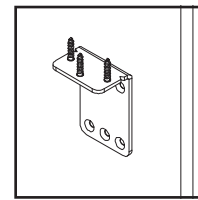

Under Surface Mount Lite

Specify

- Paint Selection for Lite Clip
- Color Selection for PET - Lite Grey, Medium Grey, Tan or Vibrant Blue

Notes

- PET L-Wrap Screens are designed to mount to AIS worksurfaces. Specify based on nominal size for the desired system. Order screens that correspond to worksurface width and depth.
- PET screen inserts are 1/2" (12mm) thick.

PET Nominal = Actual Size L-Wrap Partial Modesty Under Surface Mount Lite Screens

Material	Where Used	Screen Type	Sized For	Mount Type	Handedness
PET	L-Wrap Partial Modesty on WS	Lite	L-Wrap for Nominal = Actual Size	Under Surface Mount	Left or Right

PET NOMINAL = ACTUAL SIZE L-WRAP PARTIAL MODESTY UNDER SURFACE MOUNT LITE SCREENS

H	W	D	Left Hand	Right Hand	List
			Model Number	Model Number	
22	24	36	Y-5M4M2L223624B	Y-5M4M2R223624B	746
22	30	36	Y-5M4M2L223630B	Y-5M4M2R223630B	763
22	36	36	Y-5M4M2L223636B	Y-5M4M2R223636B	779
22	42	36	Y-5M4M2L223642B	Y-5M4M2R223642B	798
22	48	36	Y-5M4M2L223648B	Y-5M4M2R223648B	815
22	54	36	Y-5M4M2L223654B	Y-5M4M2R223654B	833
22	24	42	Y-5M4M2L224224B	Y-5M4M2R224224B	763
22	30	42	Y-5M4M2L224230B	Y-5M4M2R224230B	779
22	36	42	Y-5M4M2L224236B	Y-5M4M2R224236B	798
22	42	42	Y-5M4M2L224242B	Y-5M4M2R224242B	815
22	48	42	Y-5M4M2L224248B	Y-5M4M2R224248B	833

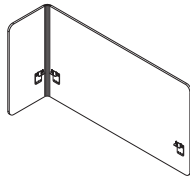

Left Hand

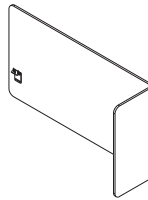

Right Hand

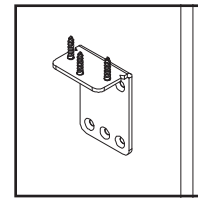

Under Surface Mount Lite

Specify

- Paint Selection for Lite Clip
- Color Selection for PET - Lite Grey, Medium Grey, Tan or Vibrant Blue

Notes

- PET L-Wrap Screens are designed to mount to AIS worksurfaces. Specify based on nominal size for the desired system. Order screens that correspond to worksurface width and depth.
- PET screen inserts are 1/2" (12mm) thick.

PET Nominal = Actual Size L-Wrap Partial Modesty Under Surface Mount Lite Screens

Material	Where Used	Screen Type	Sized For	Mount Type	Handedness
PET	L-Wrap Partial Modesty on WS	Lite	L-Wrap for Nominal = Actual Size	Under Surface Mount	Left or Right

PET NOMINAL = ACTUAL SIZE L-WRAP PARTIAL MODESTY UNDER SURFACE MOUNT LITE SCREENS

H	W	D	Left Hand	Right Hand	List
			Model Number	Model Number	
26	24	12	Y-5M4M2L261224B	Y-5M4M2R261224B	695
26	30	12	Y-5M4M2L261230B	Y-5M4M2R261230B	715
26	36	12	Y-5M4M2L261236B	Y-5M4M2R261236B	736
26	42	12	Y-5M4M2L261242B	Y-5M4M2R261242B	756
26	48	12	Y-5M4M2L261248B	Y-5M4M2R261248B	776
26	54	12	Y-5M4M2L261254B	Y-5M4M2R261254B	798
26	60	12	Y-5M4M2L261260B	Y-5M4M2R261260B	818
26	66	12	Y-5M4M2L261266B	Y-5M4M2R261266B	839
26	72	12	Y-5M4M2L261272B	Y-5M4M2R261272B	860
26	78	12	Y-5M4M2L261278B	Y-5M4M2R261278B	880
26	24	18	Y-5M4M2L261824B	Y-5M4M2R261824B	715
26	30	18	Y-5M4M2L261830B	Y-5M4M2R261830B	736
26	36	18	Y-5M4M2L261836B	Y-5M4M2R261836B	756
26	42	18	Y-5M4M2L261842B	Y-5M4M2R261842B	776
26	48	18	Y-5M4M2L261848B	Y-5M4M2R261848B	798
26	54	18	Y-5M4M2L261854B	Y-5M4M2R261854B	818
26	60	18	Y-5M4M2L261860B	Y-5M4M2R261860B	839
26	66	18	Y-5M4M2L261866B	Y-5M4M2R261866B	860
26	72	18	Y-5M4M2L261872B	Y-5M4M2R261872B	880

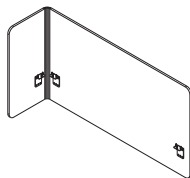

Left Hand

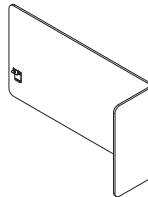

Right Hand

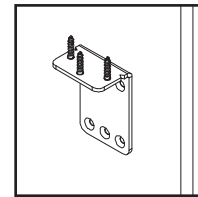

Under Surface Mount Lite

Specify

- Paint Selection for Lite Clip
- Color Selection for PET - Lite Grey, Medium Grey, Tan or Vibrant Blue

Notes

- PET L-Wrap Screens are designed to mount to AIS worksurfaces. Specify based on nominal size for the desired system. Order screens that correspond to worksurface width and depth.
- PET screen inserts are 1/2" (12mm) thick.

PET Nominal = Actual Size L-Wrap Partial Modesty Under Surface Mount Lite Screens

Material	Where Used	Screen Type	Sized For	Mount Type	Handedness
PET	L-Wrap Partial Modesty on WS	Lite	L-Wrap for Nominal = Actual Size	Under Surface Mount	Left or Right

PET NOMINAL = ACTUAL SIZE L-WRAP PARTIAL MODESTY UNDER SURFACE MOUNT LITE SCREENS

H	W	D	Left Hand	Right Hand	List
			Model Number	Model Number	
26	24	24	Y-5M4M2L262424B	Y-5M4M2R262424B	736
26	30	24	Y-5M4M2L262430B	Y-5M4M2R262430B	756
26	36	24	Y-5M4M2L262436B	Y-5M4M2R262436B	776
26	42	24	Y-5M4M2L262442B	Y-5M4M2R262442B	798
26	48	24	Y-5M4M2L262448B	Y-5M4M2R262448B	818
26	54	24	Y-5M4M2L262454B	Y-5M4M2R262454B	839
26	60	24	Y-5M4M2L262460B	Y-5M4M2R262460B	860
26	66	24	Y-5M4M2L262466B	Y-5M4M2R262466B	880
26	24	30	Y-5M4M2L263024B	Y-5M4M2R263024B	756
26	30	30	Y-5M4M2L263030B	Y-5M4M2R263030B	776
26	36	30	Y-5M4M2L263036B	Y-5M4M2R263036B	798
26	42	30	Y-5M4M2L263042B	Y-5M4M2R263042B	818
26	48	30	Y-5M4M2L263048B	Y-5M4M2R263048B	839
26	54	30	Y-5M4M2L263054B	Y-5M4M2R263054B	860
26	60	30	Y-5M4M2L263060B	Y-5M4M2R263060B	880

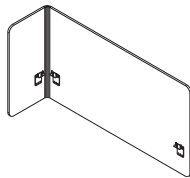

Left Hand

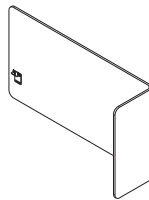

Right Hand

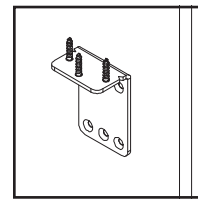

Under Surface Mount Lite

Specify

- Paint Selection for Lite Clip
- Color Selection for PET - Lite Grey, Medium Grey, Tan or Vibrant Blue

Notes

- PET L-Wrap Screens are designed to mount to AIS worksurfaces. Specify based on nominal size for the desired system. Order screens that correspond to worksurface width and depth.
- PET screen inserts are 1/2" (12mm) thick.

PET Nominal = Actual Size L-Wrap Partial Modesty Under Surface Mount Lite Screens

Material	Where Used	Screen Type	Sized For	Mount Type	Handedness
PET	L-Wrap Partial Modesty on WS	Lite	L-Wrap for Nominal = Actual Size	Under Surface Mount	Left or Right

PET NOMINAL = ACTUAL SIZE L-WRAP PARTIAL MODESTY UNDER SURFACE MOUNT LITE SCREENS

H	W	D	Left Hand	Right Hand	List
			Model Number	Model Number	
26	24	36	Y-5M4M2L263624B	Y-5M4M2R263624B	776
26	30	36	Y-5M4M2L263630B	Y-5M4M2R263630B	798
26	36	36	Y-5M4M2L263636B	Y-5M4M2R263636B	818
26	42	36	Y-5M4M2L263642B	Y-5M4M2R263642B	839
26	48	36	Y-5M4M2L263648B	Y-5M4M2R263648B	860
26	54	36	Y-5M4M2L263654B	Y-5M4M2R263654B	880
26	24	42	Y-5M4M2L264224B	Y-5M4M2R264224B	798
26	30	42	Y-5M4M2L264230B	Y-5M4M2R264230B	818
26	36	42	Y-5M4M2L264236B	Y-5M4M2R264236B	839
26	42	42	Y-5M4M2L264242B	Y-5M4M2R264242B	860
26	48	42	Y-5M4M2L264248B	Y-5M4M2R264248B	880

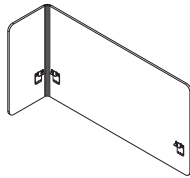

Left Hand

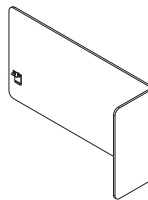

Right Hand

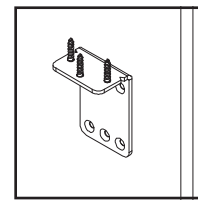

Under Surface Mount Lite

Specify

- Paint Selection for Lite Clip
- Color Selection for PET - Lite Grey, Medium Grey, Tan or Vibrant Blue

Notes

- PET L-Wrap Screens are designed to mount to AIS worksurfaces. Specify based on nominal size for the desired system. Order screens that correspond to worksurface width and depth.
- PET screen inserts are 1/2" (12mm) thick.

PET Nominal = Actual Size L-Wrap Partial Modesty Under Surface Mount Lite Screens

Material	Where Used	Screen Type	Sized For	Mount Type	Handedness
PET	L-Wrap Partial Modesty on WS	Lite	L-Wrap for Nominal = Actual Size	Under Surface Mount	Left or Right

PET NOMINAL = ACTUAL SIZE L-WRAP PARTIAL MODESTY UNDER SURFACE MOUNT LITE SCREENS

H	W	D	Left Hand	Right Hand	List
			Model Number	Model Number	
34	24	12	Y-5M4M2L341224B	Y-5M4M2R341224B	798
34	30	12	Y-5M4M2L341230B	Y-5M4M2R341230B	835
34	36	12	Y-5M4M2L341236B	Y-5M4M2R341236B	873
34	42	12	Y-5M4M2L341242B	Y-5M4M2R341242B	911
34	48	12	Y-5M4M2L341248B	Y-5M4M2R341248B	950
34	54	12	Y-5M4M2L341254B	Y-5M4M2R341254B	988
34	60	12	Y-5M4M2L341260B	Y-5M4M2R341260B	1,025
34	66	12	Y-5M4M2L341266B	Y-5M4M2R341266B	1,062
34	72	12	Y-5M4M2L341272B	Y-5M4M2R341272B	1,100
34	78	12	Y-5M4M2L341278B	Y-5M4M2R341278B	1,139
34	24	18	Y-5M4M2L341824B	Y-5M4M2R341824B	835
34	30	18	Y-5M4M2L341830B	Y-5M4M2R341830B	873
34	36	18	Y-5M4M2L341836B	Y-5M4M2R341836B	911
34	42	18	Y-5M4M2L341842B	Y-5M4M2R341842B	950
34	48	18	Y-5M4M2L341848B	Y-5M4M2R341848B	988
34	54	18	Y-5M4M2L341854B	Y-5M4M2R341854B	1,025
34	60	18	Y-5M4M2L341860B	Y-5M4M2R341860B	1,062
34	66	18	Y-5M4M2L341866B	Y-5M4M2R341866B	1,100
34	72	18	Y-5M4M2L341872B	Y-5M4M2R341872B	1,139

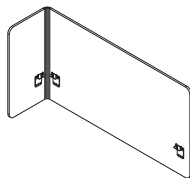

Left Hand

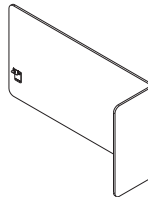

Right Hand

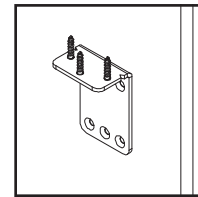

Under Surface Mount Lite

Specify

- Paint Selection for Lite Clip
- Color Selection for PET - Lite Grey, Medium Grey, Tan or Vibrant Blue

Notes

- PET L-Wrap Screens are designed to mount to AIS worksurfaces. Specify based on nominal size for the desired system. Order screens that correspond to worksurface width and depth.
- PET screen inserts are 1/2" (12mm) thick.

PET Nominal = Actual Size L-Wrap Partial Modesty Under Surface Mount Lite Screens

Material	Where Used	Screen Type	Sized For	Mount Type	Handedness
PET	L-Wrap Partial Modesty on WS	Lite	L-Wrap for Nominal = Actual Size	Under Surface Mount	Left or Right

PET NOMINAL = ACTUAL SIZE L-WRAP PARTIAL MODESTY UNDER SURFACE MOUNT LITE SCREENS

H	W	D	Left Hand	Right Hand	List
			Model Number	Model Number	
34	24	24	Y-5M4M2L342424B	Y-5M4M2R342424B	873
34	30	24	Y-5M4M2L342430B	Y-5M4M2R342430B	911
34	36	24	Y-5M4M2L342436B	Y-5M4M2R342436B	950
34	42	24	Y-5M4M2L342442B	Y-5M4M2R342442B	988
34	48	24	Y-5M4M2L342448B	Y-5M4M2R342448B	1,025
34	54	24	Y-5M4M2L342454B	Y-5M4M2R342454B	1,062
34	60	24	Y-5M4M2L342460B	Y-5M4M2R342460B	1,100
34	66	24	Y-5M4M2L342466B	Y-5M4M2R342466B	1,139
34	24	30	Y-5M4M2L343024B	Y-5M4M2R343024B	911
34	30	30	Y-5M4M2L343030B	Y-5M4M2R343030B	950
34	36	30	Y-5M4M2L343036B	Y-5M4M2R343036B	988
34	42	30	Y-5M4M2L343042B	Y-5M4M2R343042B	1,025
34	48	30	Y-5M4M2L343048B	Y-5M4M2R343048B	1,062
34	54	30	Y-5M4M2L343054B	Y-5M4M2R343054B	1,100
34	60	30	Y-5M4M2L343060B	Y-5M4M2R343060B	1,139

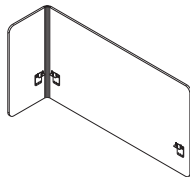

Left Hand

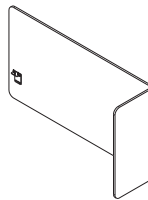

Right Hand

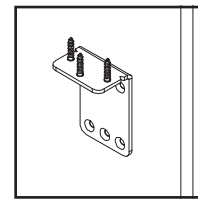

Under Surface Mount Lite

Specify

- Paint Selection for Lite Clip
- Color Selection for PET - Lite Grey, Medium Grey, Tan or Vibrant Blue

Notes

- PET L-Wrap Screens are designed to mount to AIS worksurfaces. Specify based on nominal size for the desired system. Order screens that correspond to worksurface width and depth.
- PET screen inserts are 1/2" (12mm) thick.

PET Nominal = Actual Size L-Wrap Partial Modesty Under Surface Mount Lite Screens

Material	Where Used	Screen Type	Sized For	Mount Type	Handedness
PET	L-Wrap Partial Modesty on WS	Lite	L-Wrap for Nominal = Actual Size	Under Surface Mount	Left or Right

PET NOMINAL = ACTUAL SIZE L-WRAP PARTIAL MODESTY UNDER SURFACE MOUNT LITE SCREENS

H	W	D	Left Hand	Right Hand	List
			Model Number	Model Number	
34	24	36	Y-5M4M2L343624B	Y-5M4M2R343624B	950
34	30	36	Y-5M4M2L343630B	Y-5M4M2R343630B	988
34	36	36	Y-5M4M2L343636B	Y-5M4M2R343636B	1,025
34	42	36	Y-5M4M2L343642B	Y-5M4M2R343642B	1,062
34	48	36	Y-5M4M2L343648B	Y-5M4M2R343648B	1,100
34	54	36	Y-5M4M2L343654B	Y-5M4M2R343654B	1,139
34	24	42	Y-5M4M2L344224B	Y-5M4M2R344224B	988
34	30	42	Y-5M4M2L344230B	Y-5M4M2R344230B	1,025
34	36	42	Y-5M4M2L344236B	Y-5M4M2R344236B	1,062
34	42	42	Y-5M4M2L344242B	Y-5M4M2R344242B	1,100
34	48	42	Y-5M4M2L344248B	Y-5M4M2R344248B	1,139

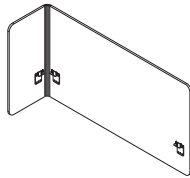

Left Hand

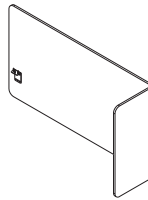

Right Hand

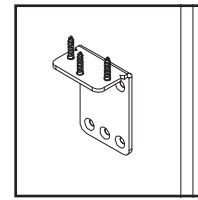

Under Surface Mount Lite

Specify

- Paint Selection for Lite Clip
- Color Selection for PET - Lite Grey, Medium Grey, Tan or Vibrant Blue

Notes

- PET L-Wrap Screens are designed to mount to AIS worksurfaces. Specify based on nominal size for the desired system. Order screens that correspond to worksurface width and depth.
- PET screen inserts are 1/2" (12mm) thick.

PET Nominal = Actual Size L-Wrap Partial Modesty Under Surface Mount Lite Screens

Material	Where Used	Screen Type	Sized For	Mount Type	Handedness
PET	L-Wrap Partial Modesty on WS	Lite	L-Wrap for Nominal = Actual Size	Under Surface Mount	Left or Right

PET NOMINAL = ACTUAL SIZE L-WRAP PARTIAL MODESTY UNDER SURFACE MOUNT LITE SCREENS

H	W	D	Left Hand	Right Hand	List
			Model Number	Model Number	
38	24	12	Y-5M4M2L381224B	Y-5M4M2R381224B	826
38	30	12	Y-5M4M2L381230B	Y-5M4M2R381230B	867
38	36	12	Y-5M4M2L381236B	Y-5M4M2R381236B	909
38	42	12	Y-5M4M2L381242B	Y-5M4M2R381242B	951
38	48	12	Y-5M4M2L381248B	Y-5M4M2R381248B	994
38	54	12	Y-5M4M2L381254B	Y-5M4M2R381254B	1,036
38	60	12	Y-5M4M2L381260B	Y-5M4M2R381260B	1,077
38	66	12	Y-5M4M2L381266B	Y-5M4M2R381266B	1,122
38	72	12	Y-5M4M2L381272B	Y-5M4M2R381272B	1,163
38	78	12	Y-5M4M2L381278B	Y-5M4M2R381278B	1,206
38	24	18	Y-5M4M2L381824B	Y-5M4M2R381824B	867
38	30	18	Y-5M4M2L381830B	Y-5M4M2R381830B	909
38	36	18	Y-5M4M2L381836B	Y-5M4M2R381836B	951
38	42	18	Y-5M4M2L381842B	Y-5M4M2R381842B	994
38	48	18	Y-5M4M2L381848B	Y-5M4M2R381848B	1,036
38	54	18	Y-5M4M2L381854B	Y-5M4M2R381854B	1,077
38	60	18	Y-5M4M2L381860B	Y-5M4M2R381860B	1,122
38	66	18	Y-5M4M2L381866B	Y-5M4M2R381866B	1,163
38	72	18	Y-5M4M2L381872B	Y-5M4M2R381872B	1,206

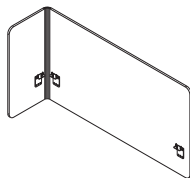

Left Hand

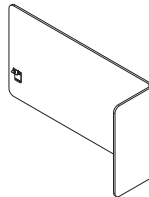

Right Hand

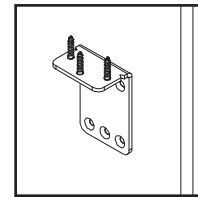

Under Surface Mount Lite

Specify

- Paint Selection for Lite Clip
- Color Selection for PET - Lite Grey, Medium Grey, Tan or Vibrant Blue

Notes

- PET L-Wrap Screens are designed to mount to AIS worksurfaces. Specify based on nominal size for the desired system. Order screens that correspond to worksurface width and depth.
- PET screen inserts are 1/2" (12mm) thick.

PET Nominal = Actual Size L-Wrap Partial Modesty Under Surface Mount Lite Screens

Material	Where Used	Screen Type	Sized For	Mount Type	Handedness
PET	L-Wrap Partial Modesty on WS	Lite	L-Wrap for Nominal = Actual Size	Under Surface Mount	Left or Right

PET NOMINAL = ACTUAL SIZE L-WRAP PARTIAL MODESTY UNDER SURFACE MOUNT LITE SCREENS

H	W	D	Left Hand	Right Hand	List
			Model Number	Model Number	
38	24	24	Y-5M4M2L382424B	Y-5M4M2R382424B	909
38	30	24	Y-5M4M2L382430B	Y-5M4M2R382430B	951
38	36	24	Y-5M4M2L382436B	Y-5M4M2R382436B	994
38	42	24	Y-5M4M2L382442B	Y-5M4M2R382442B	1,036
38	48	24	Y-5M4M2L382448B	Y-5M4M2R382448B	1,077
38	54	24	Y-5M4M2L382454B	Y-5M4M2R382454B	1,122
38	60	24	Y-5M4M2L382460B	Y-5M4M2R382460B	1,163
38	66	24	Y-5M4M2L382466B	Y-5M4M2R382466B	1,206
38	24	30	Y-5M4M2L383024B	Y-5M4M2R383024B	951
38	30	30	Y-5M4M2L383030B	Y-5M4M2R383030B	994
38	36	30	Y-5M4M2L383036B	Y-5M4M2R383036B	1,036
38	42	30	Y-5M4M2L383042B	Y-5M4M2R383042B	1,077
38	48	30	Y-5M4M2L383048B	Y-5M4M2R383048B	1,122
38	54	30	Y-5M4M2L383054B	Y-5M4M2R383054B	1,163
38	60	30	Y-5M4M2L383060B	Y-5M4M2R383060B	1,206

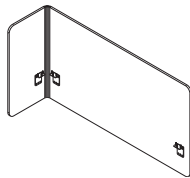

Left Hand

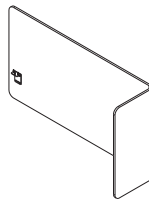

Right Hand

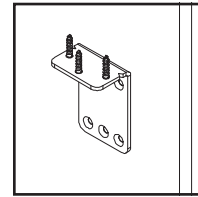

Under Surface Mount Lite

Specify

- Paint Selection for Lite Clip
- Color Selection for PET - Lite Grey, Medium Grey, Tan or Vibrant Blue

Notes

- PET L-Wrap Screens are designed to mount to AIS worksurfaces. Specify based on nominal size for the desired system. Order screens that correspond to worksurface width and depth.
- PET screen inserts are 1/2" (12mm) thick.

PET Nominal = Actual Size L-Wrap Partial Modesty Under Surface Mount Lite Screens

Material	Where Used	Screen Type	Sized For	Mount Type	Handedness
PET	L-Wrap Partial Modesty on WS	Lite	L-Wrap for Nominal = Actual Size	Under Surface Mount	Left or Right

PET NOMINAL = ACTUAL SIZE L-WRAP PARTIAL MODESTY UNDER SURFACE MOUNT LITE SCREENS

H	W	D	Left Hand	Right Hand	List
			Model Number	Model Number	
38	24	36	Y-5M4M2L383624B	Y-5M4M2R383624B	994
38	30	36	Y-5M4M2L383630B	Y-5M4M2R383630B	1,036
38	36	36	Y-5M4M2L383636B	Y-5M4M2R383636B	1,077
38	42	36	Y-5M4M2L383642B	Y-5M4M2R383642B	1,122
38	48	36	Y-5M4M2L383648B	Y-5M4M2R383648B	1,163
38	54	36	Y-5M4M2L383654B	Y-5M4M2R383654B	1,206
38	24	42	Y-5M4M2L384224B	Y-5M4M2R384224B	1,036
38	30	42	Y-5M4M2L384230B	Y-5M4M2R384230B	1,077
38	36	42	Y-5M4M2L384236B	Y-5M4M2R384236B	1,122
38	42	42	Y-5M4M2L384242B	Y-5M4M2R384242B	1,163
38	48	42	Y-5M4M2L384248B	Y-5M4M2R384248B	1,206

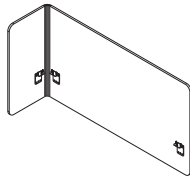

Left Hand

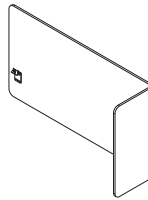

Right Hand

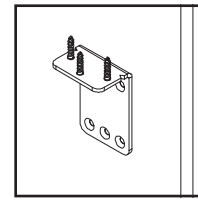

Under Surface Mount Lite

Specify

- Paint Selection for Lite Clip
- Color Selection for PET - Lite Grey, Medium Grey, Tan or Vibrant Blue

Notes

- PET L-Wrap Screens are designed to mount to AIS worksurfaces. Specify based on nominal size for the desired system. Order screens that correspond to worksurface width and depth.
- PET screen inserts are 1/2" (12mm) thick.

PET Nominal = Actual Size L-Wrap Partial Modesty Under Surface Mount Lite Screens

Material	Where Used	Screen Type	Sized For	Mount Type	Handedness
PET	L-Wrap Partial Modesty on WS	Lite	L-Wrap for Nominal = Actual Size	Under Surface Mount	Left or Right

PET NOMINAL = ACTUAL SIZE L-WRAP PARTIAL MODESTY UNDER SURFACE MOUNT LITE SCREENS

H	W	D	Left Hand	Right Hand	List
			Model Number	Model Number	
42	24	12	Y-5M4M2L421224B	Y-5M4M2R421224B	850
42	30	12	Y-5M4M2L421230B	Y-5M4M2R421230B	898
42	36	12	Y-5M4M2L421236B	Y-5M4M2R421236B	944
42	42	12	Y-5M4M2L421242B	Y-5M4M2R421242B	991
42	48	12	Y-5M4M2L421248B	Y-5M4M2R421248B	1,037
42	54	12	Y-5M4M2L421254B	Y-5M4M2R421254B	1,086
42	60	12	Y-5M4M2L421260B	Y-5M4M2R421260B	1,131
42	66	12	Y-5M4M2L421266B	Y-5M4M2R421266B	1,179
42	72	12	Y-5M4M2L421272B	Y-5M4M2R421272B	1,224
42	78	12	Y-5M4M2L421278B	Y-5M4M2R421278B	1,274
42	24	18	Y-5M4M2L421824B	Y-5M4M2R421824B	898
42	30	18	Y-5M4M2L421830B	Y-5M4M2R421830B	944
42	36	18	Y-5M4M2L421836B	Y-5M4M2R421836B	991
42	42	18	Y-5M4M2L421842B	Y-5M4M2R421842B	1,037
42	48	18	Y-5M4M2L421848B	Y-5M4M2R421848B	1,086
42	54	18	Y-5M4M2L421854B	Y-5M4M2R421854B	1,131
42	60	18	Y-5M4M2L421860B	Y-5M4M2R421860B	1,179
42	66	18	Y-5M4M2L421866B	Y-5M4M2R421866B	1,224
42	72	18	Y-5M4M2L421872B	Y-5M4M2R421872B	1,274

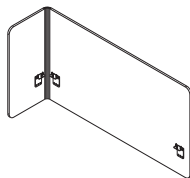

Left Hand

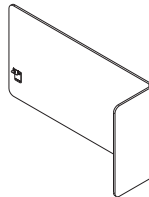

Right Hand

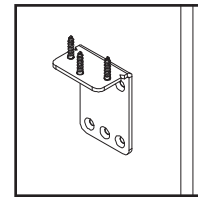

Under Surface Mount Lite

Specify

- Paint Selection for Lite Clip
- Color Selection for PET - Lite Grey, Medium Grey, Tan or Vibrant Blue

Notes

- PET L-Wrap Screens are designed to mount to AIS worksurfaces. Specify based on nominal size for the desired system. Order screens that correspond to worksurface width and depth.
- PET screen inserts are 1/2" (12mm) thick.

PET Nominal = Actual Size L-Wrap Partial Modesty Under Surface Mount Lite Screens

Material	Where Used	Screen Type	Sized For	Mount Type	Handedness
PET	L-Wrap Partial Modesty on WS	Lite	L-Wrap for Nominal = Actual Size	Under Surface Mount	Left or Right

PET NOMINAL = ACTUAL SIZE L-WRAP PARTIAL MODESTY UNDER SURFACE MOUNT LITE SCREENS

H	W	D	Left Hand	Right Hand	List
			Model Number	Model Number	
42	24	24	Y-5M4M2L422424B	Y-5M4M2R422424B	944
42	30	24	Y-5M4M2L422430B	Y-5M4M2R422430B	991
42	36	24	Y-5M4M2L422436B	Y-5M4M2R422436B	1,037
42	42	24	Y-5M4M2L422442B	Y-5M4M2R422442B	1,086
42	48	24	Y-5M4M2L422448B	Y-5M4M2R422448B	1,131
42	54	24	Y-5M4M2L422454B	Y-5M4M2R422454B	1,179
42	60	24	Y-5M4M2L422460B	Y-5M4M2R422460B	1,224
42	66	24	Y-5M4M2L422466B	Y-5M4M2R422466B	1,274
42	24	30	Y-5M4M2L423024B	Y-5M4M2R423024B	991
42	30	30	Y-5M4M2L423030B	Y-5M4M2R423030B	1,037
42	36	30	Y-5M4M2L423036B	Y-5M4M2R423036B	1,086
42	42	30	Y-5M4M2L423042B	Y-5M4M2R423042B	1,131
42	48	30	Y-5M4M2L423048B	Y-5M4M2R423048B	1,179
42	54	30	Y-5M4M2L423054B	Y-5M4M2R423054B	1,224
42	60	30	Y-5M4M2L423060B	Y-5M4M2R423060B	1,274

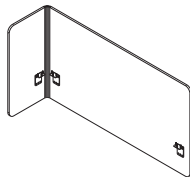

Left Hand

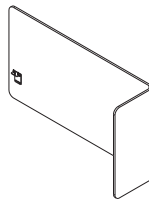

Right Hand

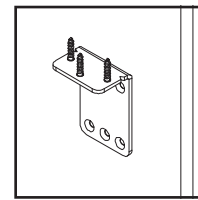

Under Surface Mount Lite

Specify

- Paint Selection for Lite Clip
- Color Selection for PET - Lite Grey, Medium Grey, Tan or Vibrant Blue

Notes

- PET L-Wrap Screens are designed to mount to AIS worksurfaces. Specify based on nominal size for the desired system. Order screens that correspond to worksurface width and depth.
- PET screen inserts are 1/2" (12mm) thick.

PET Nominal = Actual Size L-Wrap Partial Modesty Under Surface Mount Lite Screens

Material	Where Used	Screen Type	Sized For	Mount Type	Handedness
PET	L-Wrap Partial Modesty on WS	Lite	L-Wrap for Nominal = Actual Size	Under Surface Mount	Left or Right

PET NOMINAL = ACTUAL SIZE L-WRAP PARTIAL MODESTY UNDER SURFACE MOUNT LITE SCREENS

H	W	D	Left Hand	Right Hand	List
			Model Number	Model Number	
42	24	36	Y-5M4M2L423624B	Y-5M4M2R423624B	1,037
42	30	36	Y-5M4M2L423630B	Y-5M4M2R423630B	1,086
42	36	36	Y-5M4M2L423636B	Y-5M4M2R423636B	1,131
42	42	36	Y-5M4M2L423642B	Y-5M4M2R423642B	1,179
42	48	36	Y-5M4M2L423648B	Y-5M4M2R423648B	1,224
42	54	36	Y-5M4M2L423654B	Y-5M4M2R423654B	1,274
42	24	42	Y-5M4M2L424224B	Y-5M4M2R424224B	1,086
42	30	42	Y-5M4M2L424230B	Y-5M4M2R424230B	1,131
42	36	42	Y-5M4M2L424236B	Y-5M4M2R424236B	1,179
42	42	42	Y-5M4M2L424242B	Y-5M4M2R424242B	1,224
42	48	42	Y-5M4M2L424248B	Y-5M4M2R424248B	1,274

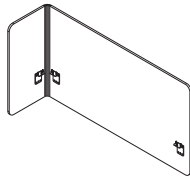

Left Hand

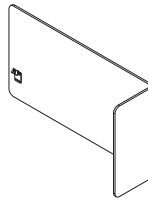

Right Hand

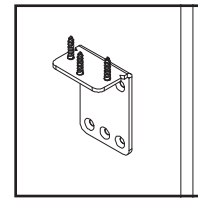

Under Surface Mount Lite

Specify

- Paint Selection for Lite Clip
- Color Selection for PET - Lite Grey, Medium Grey, Tan or Vibrant Blue

Notes

- PET L-Wrap Screens are designed to mount to AIS worksurfaces. Specify based on nominal size for the desired system. Order screens that correspond to worksurface width and depth.
- PET screen inserts are 1/2" (12mm) thick.

PET Nominal = Actual Size L-Wrap Partial Modesty Under Surface Mount Lite Screens

Material	Where Used	Screen Type	Sized For	Mount Type	Handedness
PET	L-Wrap Partial Modesty on WS	Lite	L-Wrap for Nominal = Actual Size	Under Surface Mount	Left or Right

PET NOMINAL = ACTUAL SIZE L-WRAP PARTIAL MODESTY UNDER SURFACE MOUNT LITE SCREENS

H	W	D	Left Hand	Right Hand	List
			Model Number	Model Number	
46	24	12	Y-5M4M2L461224B	Y-5M4M2R461224B	877
46	30	12	Y-5M4M2L461230B	Y-5M4M2R461230B	928
46	36	12	Y-5M4M2L461236B	Y-5M4M2R461236B	981
46	42	12	Y-5M4M2L461242B	Y-5M4M2R461242B	1,031
46	48	12	Y-5M4M2L461248B	Y-5M4M2R461248B	1,085
46	54	12	Y-5M4M2L461254B	Y-5M4M2R461254B	1,133
46	60	12	Y-5M4M2L461260B	Y-5M4M2R461260B	1,186
46	66	12	Y-5M4M2L461266B	Y-5M4M2R461266B	1,237
46	72	12	Y-5M4M2L461272B	Y-5M4M2R461272B	1,289
46	78	12	Y-5M4M2L461278B	Y-5M4M2R461278B	1,341
46	24	18	Y-5M4M2L461824B	Y-5M4M2R461824B	928
46	30	18	Y-5M4M2L461830B	Y-5M4M2R461830B	981
46	36	18	Y-5M4M2L461836B	Y-5M4M2R461836B	1,031
46	42	18	Y-5M4M2L461842B	Y-5M4M2R461842B	1,085
46	48	18	Y-5M4M2L461848B	Y-5M4M2R461848B	1,133
46	54	18	Y-5M4M2L461854B	Y-5M4M2R461854B	1,186
46	60	18	Y-5M4M2L461860B	Y-5M4M2R461860B	1,237
46	66	18	Y-5M4M2L461866B	Y-5M4M2R461866B	1,289
46	72	18	Y-5M4M2L461872B	Y-5M4M2R461872B	1,341

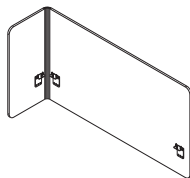

Left Hand

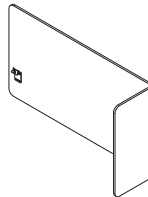

Right Hand

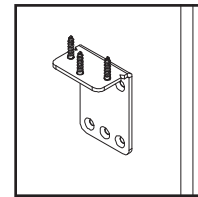

Under Surface Mount Lite

Specify

- Paint Selection for Lite Clip
- Color Selection for PET - Lite Grey, Medium Grey, Tan or Vibrant Blue

Notes

- PET L-Wrap Screens are designed to mount to AIS worksurfaces. Specify based on nominal size for the desired system. Order screens that correspond to worksurface width and depth.
- PET screen inserts are 1/2" (12mm) thick.

PET Nominal = Actual Size L-Wrap Partial Modesty Under Surface Mount Lite Screens

Material	Where Used	Screen Type	Sized For	Mount Type	Handedness
PET	L-Wrap Partial Modesty on WS	Lite	L-Wrap for Nominal = Actual Size	Under Surface Mount	Left or Right

PET NOMINAL = ACTUAL SIZE L-WRAP PARTIAL MODESTY UNDER SURFACE MOUNT LITE SCREENS

H	W	D	Left Hand	Right Hand	List
			Model Number	Model Number	
46	24	24	Y-5M4M2L462424B	Y-5M4M2R462424B	981
46	30	24	Y-5M4M2L462430B	Y-5M4M2R462430B	1,031
46	36	24	Y-5M4M2L462436B	Y-5M4M2R462436B	1,085
46	42	24	Y-5M4M2L462442B	Y-5M4M2R462442B	1,133
46	48	24	Y-5M4M2L462448B	Y-5M4M2R462448B	1,186
46	54	24	Y-5M4M2L462454B	Y-5M4M2R462454B	1,237
46	60	24	Y-5M4M2L462460B	Y-5M4M2R462460B	1,289
46	66	24	Y-5M4M2L462466B	Y-5M4M2R462466B	1,341
46	24	30	Y-5M4M2L463024B	Y-5M4M2R463024B	1,031
46	30	30	Y-5M4M2L463030B	Y-5M4M2R463030B	1,085
46	36	30	Y-5M4M2L463036B	Y-5M4M2R463036B	1,133
46	42	30	Y-5M4M2L463042B	Y-5M4M2R463042B	1,186
46	48	30	Y-5M4M2L463048B	Y-5M4M2R463048B	1,237
46	54	30	Y-5M4M2L463054B	Y-5M4M2R463054B	1,289
46	60	30	Y-5M4M2L463060B	Y-5M4M2R463060B	1,341

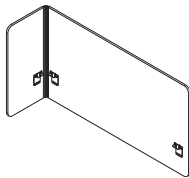

Left Hand

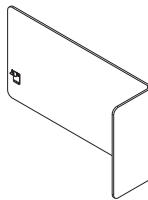

Right Hand

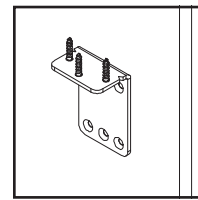

Under Surface Mount Lite

Specify

- Paint Selection for Lite Clip
- Color Selection for PET - Lite Grey, Medium Grey, Tan or Vibrant Blue

Notes

- PET L-Wrap Screens are designed to mount to AIS worksurfaces. Specify based on nominal size for the desired system. Order screens that correspond to worksurface width and depth.
- PET screen inserts are 1/2" (12mm) thick.

PET Nominal = Actual Size L-Wrap Partial Modesty Under Surface Mount Lite Screens

Material	Where Used	Screen Type	Sized For	Mount Type	Handedness
PET	L-Wrap Partial Modesty on WS	Lite	L-Wrap for Nominal = Actual Size	Under Surface Mount	Left or Right

PET NOMINAL = ACTUAL SIZE L-WRAP PARTIAL MODESTY UNDER SURFACE MOUNT LITE SCREENS

H	W	D	Left Hand	Right Hand	List
			Model Number	Model Number	
46	24	36	Y-5M4M2L463624B	Y-5M4M2R463624B	1,085
46	30	36	Y-5M4M2L463630B	Y-5M4M2R463630B	1,133
46	36	36	Y-5M4M2L463636B	Y-5M4M2R463636B	1,186
46	42	36	Y-5M4M2L463642B	Y-5M4M2R463642B	1,237
46	48	36	Y-5M4M2L463648B	Y-5M4M2R463648B	1,289
46	54	36	Y-5M4M2L463654B	Y-5M4M2R463654B	1,341
46	24	42	Y-5M4M2L464224B	Y-5M4M2R464224B	1,133
46	30	42	Y-5M4M2L464230B	Y-5M4M2R464230B	1,186
46	36	42	Y-5M4M2L464236B	Y-5M4M2R464236B	1,237
46	42	42	Y-5M4M2L464242B	Y-5M4M2R464242B	1,289
46	48	42	Y-5M4M2L464248B	Y-5M4M2R464248B	1,341

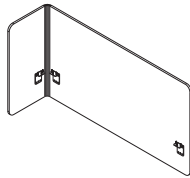

Left Hand

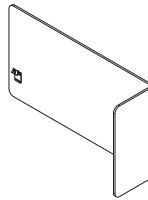

Right Hand

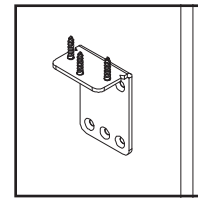

Under Surface Mount Lite

Specify

- Paint Selection for Lite Clip
- Color Selection for PET - Lite Grey, Medium Grey, Tan or Vibrant Blue

Notes

- PET L-Wrap Screens are designed to mount to AIS worksurfaces. Specify based on nominal size for the desired system. Order screens that correspond to worksurface width and depth.
- PET screen inserts are 1/2" (12mm) thick.

U-Wrap Screens Sized for
Day-to-Day, Calibrate & E-Series HAT

PET Day-to-Day, Calibrate & E-Series HAT U-Wrap Under Surface Mount Lite Screens

Material	Where Used	Screen Type	Sized For	Mount Type
PET	U-Wrap on Worksurface	Lite	L-Wrap for Day-to-Day, Calibrate & E-Series HAT	Under Surface Mount

PET DAY-TO-DAY, CALIBRATE & E-SERIES HAT U-WRAP UNDER SURFACE MOUNT LITE SCREENS

H	W	D	PET Pieces	Model Number	List
12	42	12	1	Y-5N4N2U121242B	656
12	48	12	1	Y-5N4N2U121248B	666
12	54	12	1	Y-5N4N2U121254B	675
12	60	12	1	Y-5N4N2U121260B	684
12	66	12	1	Y-5N4N2U121266B	695
12	72	12	2	Y-5N4N2U121272B	704
12	78	12	2	Y-5N4N2U121278B	713
12	84	12	2	Y-5N4N2U121284B	740
16	42	12	1	Y-5N4N2U161242B	684
16	48	12	1	Y-5N4N2U161248B	697
16	54	12	1	Y-5N4N2U161254B	710
16	60	12	1	Y-5N4N2U161260B	724
16	66	12	1	Y-5N4N2U161266B	736
16	72	12	2	Y-5N4N2U161272B	748
16	78	12	2	Y-5N4N2U161278B	761
16	84	12	2	Y-5N4N2U161284B	800

PET DAY-TO-DAY, CALIBRATE & E-SERIES HAT U-WRAP UNDER SURFACE MOUNT LITE SCREENS

H	W	D	PET Pieces	Model Number	List
20	42	12	1	Y-5N4N2U201242B	713
20	48	12	1	Y-5N4N2U201248B	729
20	54	12	1	Y-5N4N2U201254B	746
20	60	12	1	Y-5N4N2U201260B	761
20	66	12	1	Y-5N4N2U201266B	776
20	72	12	2	Y-5N4N2U201272B	794
20	78	12	2	Y-5N4N2U201278B	808
20	84	12	2	Y-5N4N2U201284B	858
24	42	12	1	Y-5N4N2U241242B	740
24	48	12	1	Y-5N4N2U241248B	761
24	54	12	1	Y-5N4N2U241254B	779
24	60	12	1	Y-5N4N2U241260B	800
24	66	12	1	Y-5N4N2U241266B	818
24	72	12	2	Y-5N4N2U241272B	837
24	78	12	2	Y-5N4N2U241278B	858
24	84	12	2	Y-5N4N2U241284B	914

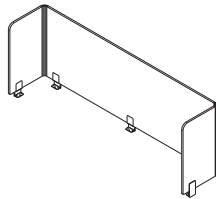

1 PET Piece

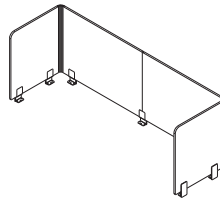

2 PET Pieces

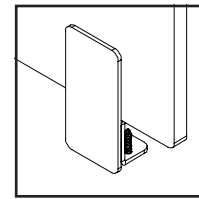

Under Surface Mount Lite

Specify

- Paint Selection for Lite Clip
- Color Selection for PET - Lite Grey, Medium Grey, Tan or Vibrant Blue

Notes

- PET U-Wrap Screens are designed to mount to AIS worksurfaces. Specify based on nominal size for the desired system. Order screens that correspond to worksurface width and depth.
- PET screen inserts are 1/2" (12mm) thick.
- U-Wrap screens typically constructed with 2 pieces of PET, some smaller sizes are constructed from 1 piece when possible. See PET Pieces column for specific details.

PET Day-to-Day, Calibrate & E-Series HAT U-Wrap Under Surface Mount Lite Screens

Material	Where Used	Screen Type	Sized For	Mount Type
PET	U-Wrap on Worksurface	Lite	L-Wrap for Day-to-Day, Calibrate & E-Series HAT	Under Surface Mount

PET DAY-TO-DAY, CALIBRATE & E-SERIES HAT U-WRAP UNDER SURFACE MOUNT LITE SCREENS

H	W	D	PET Pieces	Model Number	List
28	42	12	1	Y-5N4N2U281242B	769
28	48	12	1	Y-5N4N2U281248B	794
28	54	12	1	Y-5N4N2U281254B	815
28	60	12	1	Y-5N4N2U281260B	837
28	66	12	1	Y-5N4N2U281266B	860
28	72	12	2	Y-5N4N2U281272B	881
28	78	12	2	Y-5N4N2U281278B	904
28	84	12	2	Y-5N4N2U281284B	971
32	42	12	1	Y-5N4N2U321242B	890
32	48	12	1	Y-5N4N2U321248B	927
32	54	12	1	Y-5N4N2U321254B	962
32	60	12	1	Y-5N4N2U321260B	997
32	66	12	1	Y-5N4N2U321266B	1,033
32	72	12	2	Y-5N4N2U321272B	1,069
32	78	12	2	Y-5N4N2U321278B	1,105
32	84	12	2	Y-5N4N2U321284B	1,212

PET DAY-TO-DAY, CALIBRATE & E-SERIES HAT U-WRAP UNDER SURFACE MOUNT LITE SCREENS

H	W	D	PET Pieces	Model Number	List
12	42	18	1	Y-5N4N2U121842B	666
12	48	18	1	Y-5N4N2U121848B	675
12	54	18	1	Y-5N4N2U121854B	684
12	60	18	2	Y-5N4N2U121860B	695
12	66	18	2	Y-5N4N2U121866B	704
12	72	18	2	Y-5N4N2U121872B	713
12	78	18	2	Y-5N4N2U121878B	753
12	84	18	2	Y-5N4N2U121884B	761
16	42	18	1	Y-5N4N2U161842B	697
16	48	18	1	Y-5N4N2U161848B	710
16	54	18	1	Y-5N4N2U161854B	724
16	60	18	2	Y-5N4N2U161860B	736
16	66	18	2	Y-5N4N2U161866B	748
16	72	18	2	Y-5N4N2U161872B	761
16	78	18	2	Y-5N4N2U161878B	810
16	84	18	2	Y-5N4N2U161884B	826

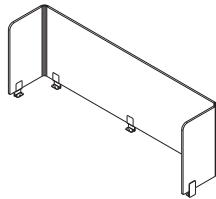

1 PET Piece

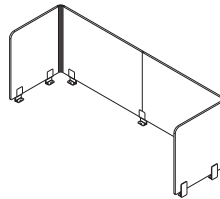

2 PET Pieces

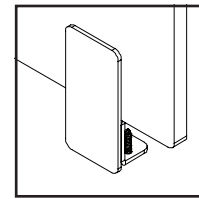

Under Surface Mount Lite

Specify

- Paint Selection for Lite Clip
- Color Selection for PET - Lite Grey, Medium Grey, Tan or Vibrant Blue

Notes

- PET U-Wrap Screens are designed to mount to AIS worksurfaces. Specify based on nominal size for the desired system. Order screens that correspond to worksurface width and depth.
- PET screen inserts are 1/2" (12mm) thick.
- U-Wrap screens typically constructed with 2 pieces of PET, some smaller sizes are constructed from 1 piece when possible. See PET Pieces column for specific details.

PET Day-to-Day, Calibrate & E-Series HAT U-Wrap Under Surface Mount Lite Screens

Material	Where Used	Screen Type	Sized For	Mount Type
PET	U-Wrap on Worksurface	Lite	L-Wrap for Day-to-Day, Calibrate & E-Series HAT	Under Surface Mount

PET DAY-TO-DAY, CALIBRATE & E-SERIES HAT U-WRAP UNDER SURFACE MOUNT LITE SCREENS

H	W	D	PET Pieces	Model Number	List
20	42	18	1	Y-5N4N2U201842B	729
20	48	18	1	Y-5N4N2U201848B	746
20	54	18	1	Y-5N4N2U201854B	761
20	60	18	2	Y-5N4N2U201860B	776
20	66	18	2	Y-5N4N2U201866B	794
20	72	18	2	Y-5N4N2U201872B	808
20	78	18	2	Y-5N4N2U201878B	873
20	84	18	2	Y-5N4N2U201884B	888
24	42	18	1	Y-5N4N2U241842B	761
24	48	18	1	Y-5N4N2U241848B	779
24	54	18	1	Y-5N4N2U241854B	800
24	60	18	2	Y-5N4N2U241860B	818
24	66	18	2	Y-5N4N2U241866B	837
24	72	18	2	Y-5N4N2U241872B	858
24	78	18	2	Y-5N4N2U241878B	934
24	84	18	2	Y-5N4N2U241884B	952

PET DAY-TO-DAY, CALIBRATE & E-SERIES HAT U-WRAP UNDER SURFACE MOUNT LITE SCREENS

H	W	D	PET Pieces	Model Number	List
28	42	18	1	Y-5N4N2U281842B	794
28	48	18	1	Y-5N4N2U281848B	815
28	54	18	1	Y-5N4N2U281854B	837
28	60	18	2	Y-5N4N2U281860B	860
28	66	18	2	Y-5N4N2U281866B	881
28	72	18	2	Y-5N4N2U281872B	904
28	78	18	2	Y-5N4N2U281878B	994
28	84	18	2	Y-5N4N2U281884B	1,017
32	42	18	1	Y-5N4N2U321842B	927
32	48	18	1	Y-5N4N2U321848B	962
32	54	18	1	Y-5N4N2U321854B	997
32	60	18	2	Y-5N4N2U321860B	1,033
32	66	18	2	Y-5N4N2U321866B	1,069
32	72	18	2	Y-5N4N2U321872B	1,105
32	78	18	2	Y-5N4N2U321878B	1,249
32	84	18	2	Y-5N4N2U321884B	1,284

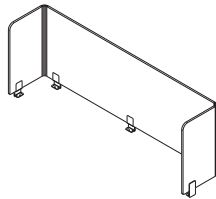

1 PET Piece

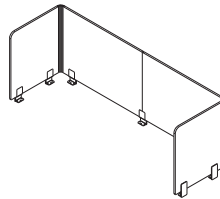

2 PET Pieces

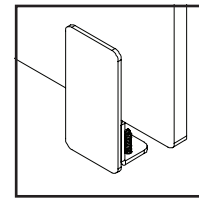

Under Surface Mount Lite

Specify

- Paint Selection for Lite Clip
- Color Selection for PET - Lite Grey, Medium Grey, Tan or Vibrant Blue

Notes

- PET U-Wrap Screens are designed to mount to AIS worksurfaces. Specify based on nominal size for the desired system. Order screens that correspond to worksurface width and depth.
- PET screen inserts are 1/2" (12mm) thick.
- U-Wrap screens typically constructed with 2 pieces of PET, some smaller sizes are constructed from 1 piece when possible. See PET Pieces column for specific details.

PET Day-to-Day, Calibrate & E-Series HAT U-Wrap Under Surface Mount Lite Screens

Material	Where Used	Screen Type	Sized For	Mount Type
PET	U-Wrap on Worksurface	Lite	L-Wrap for Day-to-Day, Calibrate & E-Series HAT	Under Surface Mount

PET DAY-TO-DAY, CALIBRATE & E-SERIES HAT U-WRAP UNDER SURFACE MOUNT LITE SCREENS

H	W	D	PET Pieces	Model Number	List
12	42	24	1	Y-5N4N2U122442B	675
12	48	24	2	Y-5N4N2U122448B	684
12	54	24	2	Y-5N4N2U122454B	695
12	60	24	2	Y-5N4N2U122460B	704
12	66	24	2	Y-5N4N2U122466B	713
12	72	24	2	Y-5N4N2U122472B	761
12	78	24	2	Y-5N4N2U122478B	769
12	84	24	2	Y-5N4N2U122484B	779
16	42	24	1	Y-5N4N2U162442B	710
16	48	24	2	Y-5N4N2U162448B	724
16	54	24	2	Y-5N4N2U162454B	736
16	60	24	2	Y-5N4N2U162460B	748
16	66	24	2	Y-5N4N2U162466B	761
16	72	24	2	Y-5N4N2U162472B	826
16	78	24	2	Y-5N4N2U162478B	837
16	84	24	2	Y-5N4N2U162484B	850

PET DAY-TO-DAY, CALIBRATE & E-SERIES HAT U-WRAP UNDER SURFACE MOUNT LITE SCREENS

H	W	D	PET Pieces	Model Number	List
20	42	24	1	Y-5N4N2U202442B	746
20	48	24	2	Y-5N4N2U202448B	761
20	54	24	2	Y-5N4N2U202454B	776
20	60	24	2	Y-5N4N2U202460B	794
20	66	24	2	Y-5N4N2U202466B	808
20	72	24	2	Y-5N4N2U202472B	888
20	78	24	2	Y-5N4N2U202478B	904
20	84	24	2	Y-5N4N2U202484B	921
24	42	24	1	Y-5N4N2U242442B	779
24	48	24	2	Y-5N4N2U242448B	800
24	54	24	2	Y-5N4N2U242454B	818
24	60	24	2	Y-5N4N2U242460B	837
24	66	24	2	Y-5N4N2U242466B	858
24	72	24	2	Y-5N4N2U242472B	952
24	78	24	2	Y-5N4N2U242478B	971
24	84	24	2	Y-5N4N2U242484B	991

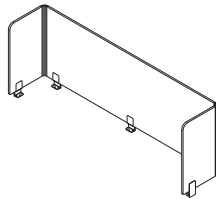

1 PET Piece

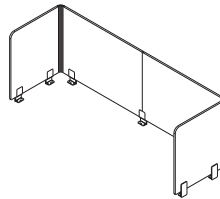

2 PET Pieces

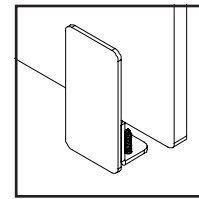

Under Surface Mount Lite

Specify

- Paint Selection for Lite Clip
- Color Selection for PET - Lite Grey, Medium Grey, Tan or Vibrant Blue

Notes

- PET U-Wrap Screens are designed to mount to AIS worksurfaces. Specify based on nominal size for the desired system. Order screens that correspond to worksurface width and depth.
- PET screen inserts are 1/2" (12mm) thick.
- U-Wrap screens typically constructed with 2 pieces of PET, some smaller sizes are constructed from 1 piece when possible. See PET Pieces column for specific details.

PET Day-to-Day, Calibrate & E-Series HAT U-Wrap Under Surface Mount Lite Screens

Material	Where Used	Screen Type	Sized For	Mount Type
PET	U-Wrap on Worksurface	Lite	L-Wrap for Day-to-Day, Calibrate & E-Series HAT	Under Surface Mount

PET DAY-TO-DAY, CALIBRATE & E-SERIES HAT U-WRAP UNDER SURFACE MOUNT LITE SCREENS

H	W	D	PET Pieces	Model Number	List
28	42	24	1	Y-5N4N2U282442B	815
28	48	24	2	Y-5N4N2U282448B	837
28	54	24	2	Y-5N4N2U282454B	860
28	60	24	2	Y-5N4N2U282460B	881
28	66	24	2	Y-5N4N2U282466B	904
28	72	24	2	Y-5N4N2U282472B	1,017
28	78	24	2	Y-5N4N2U282478B	1,037
28	84	24	2	Y-5N4N2U282484B	1,061
32	42	24	1	Y-5N4N2U322442B	962
32	48	24	2	Y-5N4N2U322448B	997
32	54	24	2	Y-5N4N2U322454B	1,033
32	60	24	2	Y-5N4N2U322460B	1,069
32	66	24	2	Y-5N4N2U322466B	1,105
32	72	24	2	Y-5N4N2U322472B	1,284
32	78	24	2	Y-5N4N2U322478B	1,320
32	84	24	2	Y-5N4N2U322484B	1,355

PET DAY-TO-DAY, CALIBRATE & E-SERIES HAT U-WRAP UNDER SURFACE MOUNT LITE SCREENS

H	W	D	PET Pieces	Model Number	List
12	42	30	2	Y-5N4N2U123042B	684
12	48	30	2	Y-5N4N2U123048B	695
12	54	30	2	Y-5N4N2U123054B	704
12	60	30	2	Y-5N4N2U123060B	713
12	66	30	2	Y-5N4N2U123066B	769
12	72	30	2	Y-5N4N2U123072B	779
12	78	30	2	Y-5N4N2U123078B	790
12	84	30	2	Y-5N4N2U123084B	800
16	42	30	2	Y-5N4N2U163042B	724
16	48	30	2	Y-5N4N2U163048B	736
16	54	30	2	Y-5N4N2U163054B	748
16	60	30	2	Y-5N4N2U163060B	761
16	66	30	2	Y-5N4N2U163066B	837
16	72	30	2	Y-5N4N2U163072B	850
16	78	30	2	Y-5N4N2U163078B	864
16	84	30	2	Y-5N4N2U163084B	875

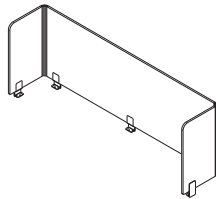

1 PET Piece

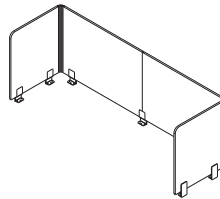

2 PET Pieces

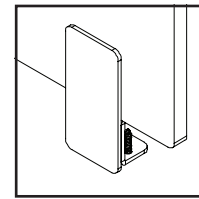

Under Surface Mount Lite

Specify

- Paint Selection for Lite Clip
- Color Selection for PET - Lite Grey, Medium Grey, Tan or Vibrant Blue

Notes

- PET U-Wrap Screens are designed to mount to AIS worksurfaces. Specify based on nominal size for the desired system. Order screens that correspond to worksurface width and depth.
- PET screen inserts are 1/2" (12mm) thick.
- U-Wrap screens typically constructed with 2 pieces of PET, some smaller sizes are constructed from 1 piece when possible. See PET Pieces column for specific details.

PET Day-to-Day, Calibrate & E-Series HAT U-Wrap Under Surface Mount Lite Screens

Material	Where Used	Screen Type	Sized For	Mount Type
PET	U-Wrap on Worksurface	Lite	L-Wrap for Day-to-Day, Calibrate & E-Series HAT	Under Surface Mount

PET DAY-TO-DAY, CALIBRATE & E-SERIES HAT U-WRAP UNDER SURFACE MOUNT LITE SCREENS

H	W	D	PET Pieces	Model Number	List
20	42	30	2	Y-5N4N2U203042B	761
20	48	30	2	Y-5N4N2U203048B	776
20	54	30	2	Y-5N4N2U203054B	794
20	60	30	2	Y-5N4N2U203060B	808
20	66	30	2	Y-5N4N2U203066B	904
20	72	30	2	Y-5N4N2U203072B	921
20	78	30	2	Y-5N4N2U203078B	937
20	84	30	2	Y-5N4N2U203084B	952
24	42	30	2	Y-5N4N2U243042B	800
24	48	30	2	Y-5N4N2U243048B	818
24	54	30	2	Y-5N4N2U243054B	837
24	60	30	2	Y-5N4N2U243060B	858
24	66	30	2	Y-5N4N2U243066B	971
24	72	30	2	Y-5N4N2U243072B	991
24	78	30	2	Y-5N4N2U243078B	1,009
24	84	30	2	Y-5N4N2U243084B	1,029

PET DAY-TO-DAY, CALIBRATE & E-SERIES HAT U-WRAP UNDER SURFACE MOUNT LITE SCREENS

H	W	D	PET Pieces	Model Number	List
28	42	30	2	Y-5N4N2U283042B	837
28	48	30	2	Y-5N4N2U283048B	860
28	54	30	2	Y-5N4N2U283054B	881
28	60	30	2	Y-5N4N2U283060B	904
28	66	30	2	Y-5N4N2U283066B	1,037
28	72	30	2	Y-5N4N2U283072B	1,061
28	78	30	2	Y-5N4N2U283078B	1,085
28	84	30	2	Y-5N4N2U283084B	1,105
32	42	30	2	Y-5N4N2U323042B	997
32	48	30	2	Y-5N4N2U323048B	1,033
32	54	30	2	Y-5N4N2U323054B	1,069
32	60	30	2	Y-5N4N2U323060B	1,105
32	66	30	2	Y-5N4N2U323066B	1,320
32	72	30	2	Y-5N4N2U323072B	1,355
32	78	30	2	Y-5N4N2U323078B	1,390
32	84	30	2	Y-5N4N2U323084B	1,426

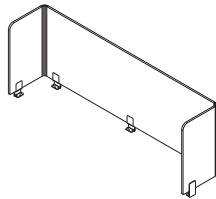

1 PET Piece

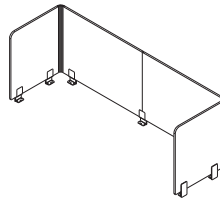

2 PET Pieces

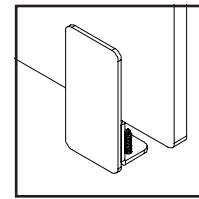

Under Surface Mount Lite

Specify

- Paint Selection for Lite Clip
- Color Selection for PET - Lite Grey, Medium Grey, Tan or Vibrant Blue

Notes

- PET U-Wrap Screens are designed to mount to AIS worksurfaces. Specify based on nominal size for the desired system. Order screens that correspond to worksurface width and depth.
- PET screen inserts are 1/2" (12mm) thick.
- U-Wrap screens typically constructed with 2 pieces of PET, some smaller sizes are constructed from 1 piece when possible. See PET Pieces column for specific details.

PET Day-to-Day, Calibrate & E-Series HAT U-Wrap Under Surface Mount Lite Screens

Material	Where Used	Screen Type	Sized For	Mount Type
PET	U-Wrap on Worksurface	Lite	L-Wrap for Day-to-Day, Calibrate & E-Series HAT	Under Surface Mount

PET DAY-TO-DAY, CALIBRATE & E-SERIES HAT U-WRAP UNDER SURFACE MOUNT LITE SCREENS

H	W	D	PET Pieces	Model Number	List
12	42	36	2	Y-5N4N2U123642B	695
12	48	36	2	Y-5N4N2U123648B	704
12	54	36	2	Y-5N4N2U123654B	713
12	60	36	2	Y-5N4N2U123660B	779
12	66	36	2	Y-5N4N2U123666B	790
12	72	36	2	Y-5N4N2U123672B	800
12	78	36	2	Y-5N4N2U123678B	808
12	84	36	2	Y-5N4N2U123684B	818
16	42	36	2	Y-5N4N2U163642B	736
16	48	36	2	Y-5N4N2U163648B	748
16	54	36	2	Y-5N4N2U163654B	761
16	60	36	2	Y-5N4N2U163660B	850
16	66	36	2	Y-5N4N2U163666B	864
16	72	36	2	Y-5N4N2U163672B	875
16	78	36	2	Y-5N4N2U163678B	888
16	84	36	2	Y-5N4N2U163684B	901

PET DAY-TO-DAY, CALIBRATE & E-SERIES HAT U-WRAP UNDER SURFACE MOUNT LITE SCREENS

H	W	D	PET Pieces	Model Number	List
20	42	36	2	Y-5N4N2U203642B	776
20	48	36	2	Y-5N4N2U203648B	794
20	54	36	2	Y-5N4N2U203654B	808
20	60	36	2	Y-5N4N2U203660B	921
20	66	36	2	Y-5N4N2U203666B	937
20	72	36	2	Y-5N4N2U203672B	952
20	78	36	2	Y-5N4N2U203678B	968
20	84	36	2	Y-5N4N2U203684B	985
24	42	36	2	Y-5N4N2U243642B	818
24	48	36	2	Y-5N4N2U243648B	837
24	54	36	2	Y-5N4N2U243654B	858
24	60	36	2	Y-5N4N2U243660B	991
24	66	36	2	Y-5N4N2U243666B	1,009
24	72	36	2	Y-5N4N2U243672B	1,029
24	78	36	2	Y-5N4N2U243678B	1,049
24	84	36	2	Y-5N4N2U243684B	1,066

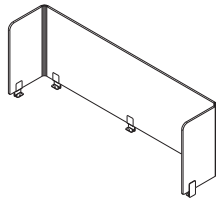

1 PET Piece

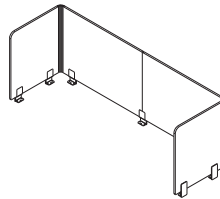

2 PET Pieces

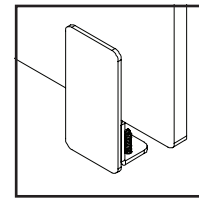

Under Surface Mount Lite

Specify

- Paint Selection for Lite Clip
- Color Selection for PET - Lite Grey, Medium Grey, Tan or Vibrant Blue

Notes

- PET U-Wrap Screens are designed to mount to AIS worksurfaces. Specify based on nominal size for the desired system. Order screens that correspond to worksurface width and depth.
- PET screen inserts are 1/2" (12mm) thick.
- U-Wrap screens typically constructed with 2 pieces of PET, some smaller sizes are constructed from 1 piece when possible. See PET Pieces column for specific details.

PET Day-to-Day, Calibrate & E-Series HAT U-Wrap Under Surface Mount Lite Screens

Material	Where Used	Screen Type	Sized For	Mount Type
PET	U-Wrap on Worksurface	Lite	L-Wrap for Day-to-Day, Calibrate & E-Series HAT	Under Surface Mount

PET DAY-TO-DAY, CALIBRATE & E-SERIES HAT U-WRAP UNDER SURFACE MOUNT LITE SCREENS

H	W	D	PET Pieces	Model Number	List
28	42	36	2	Y-5N4N2U283642B	860
28	48	36	2	Y-5N4N2U283648B	881
28	54	36	2	Y-5N4N2U283654B	904
28	60	36	2	Y-5N4N2U283660B	1,061
28	66	36	2	Y-5N4N2U283666B	1,085
28	72	36	2	Y-5N4N2U283672B	1,105
28	78	36	2	Y-5N4N2U283678B	1,128
28	84	36	2	Y-5N4N2U283684B	1,150
32	42	36	2	Y-5N4N2U323642B	1,033
32	48	36	2	Y-5N4N2U323648B	1,069
32	54	36	2	Y-5N4N2U323654B	1,105
32	60	36	2	Y-5N4N2U323660B	1,355
32	66	36	2	Y-5N4N2U323666B	1,390
32	72	36	2	Y-5N4N2U323672B	1,426
32	78	36	2	Y-5N4N2U323678B	1,462
32	84	36	2	Y-5N4N2U323684B	1,498

PET DAY-TO-DAY, CALIBRATE & E-SERIES HAT U-WRAP UNDER SURFACE MOUNT LITE SCREENS

H	W	D	PET Pieces	Model Number	List
12	42	42	2	Y-5N4N2U124242B	704
12	48	42	2	Y-5N4N2U124248B	713
12	54	42	2	Y-5N4N2U124254B	790
12	60	42	2	Y-5N4N2U124260B	800
12	66	42	2	Y-5N4N2U124266B	808
12	72	42	2	Y-5N4N2U124272B	818
12	78	42	2	Y-5N4N2U124278B	829
12	84	42	2	Y-5N4N2U124284B	837
16	42	42	2	Y-5N4N2U164242B	748
16	48	42	2	Y-5N4N2U164248B	761
16	54	42	2	Y-5N4N2U164254B	864
16	60	42	2	Y-5N4N2U164260B	875
16	66	42	2	Y-5N4N2U164266B	888
16	72	42	2	Y-5N4N2U164272B	901
16	78	42	2	Y-5N4N2U164278B	914
16	84	42	2	Y-5N4N2U164284B	927

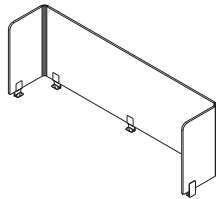

1 PET Piece

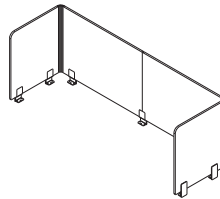

2 PET Pieces

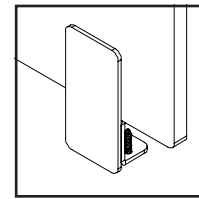

Under Surface Mount Lite

Specify

- Paint Selection for Lite Clip
- Color Selection for PET - Lite Grey, Medium Grey, Tan or Vibrant Blue

Notes

- PET U-Wrap Screens are designed to mount to AIS worksurfaces. Specify based on nominal size for the desired system. Order screens that correspond to worksurface width and depth.
- PET screen inserts are 1/2" (12mm) thick.
- U-Wrap screens typically constructed with 2 pieces of PET, some smaller sizes are constructed from 1 piece when possible. See PET Pieces column for specific details.

PET Day-to-Day, Calibrate & E-Series HAT U-Wrap Under Surface Mount Lite Screens

Material	Where Used	Screen Type	Sized For	Mount Type
PET	U-Wrap on Worksurface	Lite	L-Wrap for Day-to-Day, Calibrate & E-Series HAT	Under Surface Mount

PET DAY-TO-DAY, CALIBRATE & E-SERIES HAT U-WRAP UNDER SURFACE MOUNT LITE SCREENS

H	W	D	PET Pieces	Model Number	List
20	42	42	2	Y-5N4N2U204242B	794
20	48	42	2	Y-5N4N2U204248B	808
20	54	42	2	Y-5N4N2U204254B	937
20	60	42	2	Y-5N4N2U204260B	952
20	66	42	2	Y-5N4N2U204266B	968
20	72	42	2	Y-5N4N2U204272B	985
20	78	42	2	Y-5N4N2U204278B	999
20	84	42	2	Y-5N4N2U204284B	1,017
24	42	42	2	Y-5N4N2U244242B	837
24	48	42	2	Y-5N4N2U244248B	858
24	54	42	2	Y-5N4N2U244254B	1,009
24	60	42	2	Y-5N4N2U244260B	1,029
24	66	42	2	Y-5N4N2U244266B	1,049
24	72	42	2	Y-5N4N2U244272B	1,066
24	78	42	2	Y-5N4N2U244278B	1,087
24	84	42	2	Y-5N4N2U244284B	1,105

PET DAY-TO-DAY, CALIBRATE & E-SERIES HAT U-WRAP UNDER SURFACE MOUNT LITE SCREENS

H	W	D	PET Pieces	Model Number	List
28	42	42	2	Y-5N4N2U284242B	881
28	48	42	2	Y-5N4N2U284248B	904
28	54	42	2	Y-5N4N2U284254B	1,085
28	60	42	2	Y-5N4N2U284260B	1,105
28	66	42	2	Y-5N4N2U284266B	1,128
28	72	42	2	Y-5N4N2U284272B	1,150
28	78	42	2	Y-5N4N2U284278B	1,171
28	84	42	2	Y-5N4N2U284284B	1,194
32	42	42	2	Y-5N4N2U324242B	1,069
32	48	42	2	Y-5N4N2U324248B	1,105
32	54	42	2	Y-5N4N2U324254B	1,390
32	60	42	2	Y-5N4N2U324260B	1,426
32	66	42	2	Y-5N4N2U324266B	1,462
32	72	42	2	Y-5N4N2U324272B	1,498
32	78	42	2	Y-5N4N2U324278B	1,533
32	84	42	2	Y-5N4N2U324284B	1,571

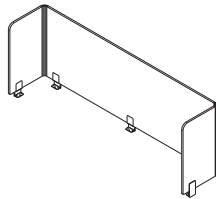

1 PET Piece

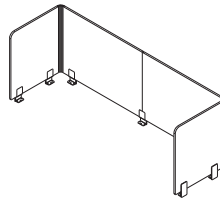

2 PET Pieces

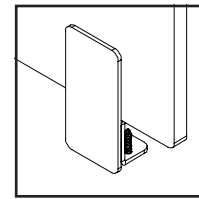

Under Surface Mount Lite

Specify

- Paint Selection for Lite Clip
- Color Selection for PET - Lite Grey, Medium Grey, Tan or Vibrant Blue

Notes

- PET U-Wrap Screens are designed to mount to AIS worksurfaces. Specify based on nominal size for the desired system. Order screens that correspond to worksurface width and depth.
- PET screen inserts are 1/2" (12mm) thick.
- U-Wrap screens typically constructed with 2 pieces of PET, some smaller sizes are constructed from 1 piece when possible. See PET Pieces column for specific details.

PET Day-to-Day, Calibrate & E-Series HAT U-Wrap Partial Modesty Under Surface Mount Lite Screens

Material	Where Used	Screen Type	Sized For	Mount Type	Handedness
PET	U-Wrap Partial Modesty on WS	Lite	U-Wrap for Day-to-Day, Calibrate & E-Series HAT	Under Surface Mount	Left or Right

**PET DAY-TO-DAY, CALIBRATE & E-SERIES HAT
U-WRAP PARTIAL MODESTY UNDER SURFACE MOUNT LITE SCREENS**

H	W	D	PET Pieces	Model Number	List
22	42	12	1 PC	Y-5Q4N2U221242B	727
22	48	12	1 PC	Y-5Q4N2U221248B	746
22	54	12	1 PC	Y-5Q4N2U221254B	763
22	60	12	1 PC	Y-5Q4N2U221260B	779
22	66	12	1 PC	Y-5Q4N2U221266B	798
22	72	12	2 PC	Y-5Q4N2U221272B	815
22	78	12	2 PC	Y-5Q4N2U221278B	833
22	84	12	2 PC	Y-5Q4N2U221284B	886
26	42	12	1 PC	Y-5Q4N2U261242B	756
26	48	12	1 PC	Y-5Q4N2U261248B	776
26	54	12	1 PC	Y-5Q4N2U261254B	798
26	60	12	1 PC	Y-5Q4N2U261260B	818
26	66	12	1 PC	Y-5Q4N2U261266B	839
26	72	12	2 PC	Y-5Q4N2U261272B	860
26	78	12	2 PC	Y-5Q4N2U261278B	880
26	84	12	2 PC	Y-5Q4N2U261284B	942

**PET DAY-TO-DAY, CALIBRATE & E-SERIES HAT
U-WRAP PARTIAL MODESTY UNDER SURFACE MOUNT LITE SCREENS**

H	W	D	PET Pieces	Model Number	List
30	42	12	1 PC	Y-5Q4N2U301242B	938
30	48	12	1 PC	Y-5Q4N2U301248B	971
30	54	12	1 PC	Y-5Q4N2U301254B	1,006
30	60	12	1 PC	Y-5Q4N2U301260B	1,037
30	66	12	1 PC	Y-5Q4N2U301266B	1,071
30	72	12	2 PC	Y-5Q4N2U301272B	1,105
30	78	12	2 PC	Y-5Q4N2U301278B	1,139
30	84	12	2 PC	Y-5Q4N2U301284B	1,171
34	42	12	1 PC	Y-5Q4N2U341242B	911
34	48	12	1 PC	Y-5Q4N2U341248B	950
34	54	12	1 PC	Y-5Q4N2U341254B	988
34	60	12	1 PC	Y-5Q4N2U341260B	1,025
34	66	12	1 PC	Y-5Q4N2U341266B	1,062
34	72	12	2 PC	Y-5Q4N2U341272B	1,100
34	78	12	2 PC	Y-5Q4N2U341278B	1,139
34	84	12	2 PC	Y-5Q4N2U341284B	1,252

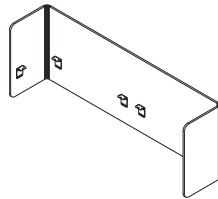

1 PET Piece

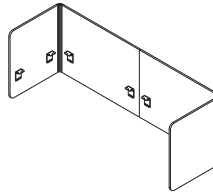

2 PET Pieces

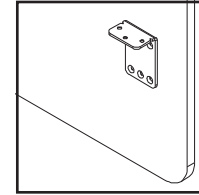

Partial Modesty L-Brackets

Specify

- Paint Selection for Lite Clip
- Color Selection for PET - Lite Grey, Medium Grey, Tan or Vibrant Blue

Notes

- PET U-Wrap Screens are designed to mount to AIS worksurfaces. Specify based on nominal size for the desired system. Order screens that correspond to worksurface width and depth.
- PET screen inserts are 1/2" (12mm) thick.
- U-Wrap screens typically constructed with 2 pieces of PET, some smaller sizes are constructed from 1 piece when possible. See PET Pieces column for specific details.

PET Day-to-Day, Calibrate & E-Series HAT U-Wrap Partial Modesty Under Surface Mount Lite Screens

Material	Where Used	Screen Type	Sized For	Mount Type	Handedness
PET	U-Wrap Partial Modesty on WS	Lite	U-Wrap for Day-to-Day, Calibrate & E-Series HAT	Under Surface Mount	Left or Right

PET DAY-TO-DAY, CALIBRATE & E-SERIES HAT U-WRAP PARTIAL MODESTY UNDER SURFACE MOUNT LITE SCREENS

H	W	D	PET Pieces	Model Number	List
38	42	12	1 PC	Y-5Q4N2U381242B	951
38	48	12	1 PC	Y-5Q4N2U381248B	994
38	54	12	1 PC	Y-5Q4N2U381254B	1,036
38	60	12	1 PC	Y-5Q4N2U381260B	1,077
38	66	12	1 PC	Y-5Q4N2U381266B	1,122
38	72	12	2 PC	Y-5Q4N2U381272B	1,163
38	78	12	2 PC	Y-5Q4N2U381278B	1,206
38	84	12	2 PC	Y-5Q4N2U381284B	1,332
42	42	12	1 PC	Y-5Q4N2U421242B	991
42	48	12	1 PC	Y-5Q4N2U421248B	1,037
42	54	12	1 PC	Y-5Q4N2U421254B	1,086
42	60	12	1 PC	Y-5Q4N2U421260B	1,131
42	66	12	1 PC	Y-5Q4N2U421266B	1,179
42	72	12	2 PC	Y-5Q4N2U421272B	1,224
42	78	12	2 PC	Y-5Q4N2U421278B	1,274
42	84	12	2 PC	Y-5Q4N2U421284B	1,414

PET DAY-TO-DAY, CALIBRATE & E-SERIES HAT U-WRAP PARTIAL MODESTY UNDER SURFACE MOUNT LITE SCREENS

H	W	D	PET Pieces	Model Number	List
22	42	18	1 PC	Y-5Q4N2U221842B	746
22	48	18	1 PC	Y-5Q4N2U221848B	763
22	54	18	1 PC	Y-5Q4N2U221854B	779
22	60	18	2 PC	Y-5Q4N2U221860B	798
22	66	18	2 PC	Y-5Q4N2U221866B	815
22	72	18	2 PC	Y-5Q4N2U221872B	833
22	78	18	2 PC	Y-5Q4N2U221878B	903
22	84	18	2 PC	Y-5Q4N2U221884B	921
26	42	18	1 PC	Y-5Q4N2U261842B	776
26	48	18	1 PC	Y-5Q4N2U261848B	798
26	54	18	1 PC	Y-5Q4N2U261854B	818
26	60	18	2 PC	Y-5Q4N2U261860B	839
26	66	18	2 PC	Y-5Q4N2U261866B	860
26	72	18	2 PC	Y-5Q4N2U261872B	880
26	78	18	2 PC	Y-5Q4N2U261878B	964
26	84	18	2 PC	Y-5Q4N2U261884B	985

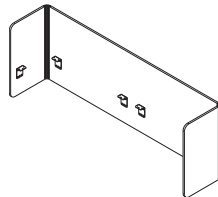

1 PET Piece

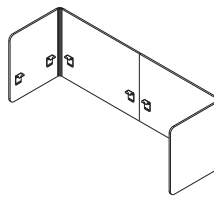

2 PET Pieces

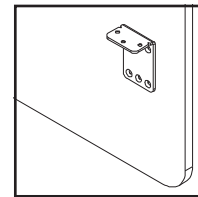

Partial Modesty L-Brackets

Specify

- Paint Selection for Lite Clip
- Color Selection for PET - Lite Grey, Medium Grey, Tan or Vibrant Blue

Notes

- PET U-Wrap Screens are designed to mount to AIS worksurfaces. Specify based on nominal size for the desired system. Order screens that correspond to worksurface width and depth.
- PET screen inserts are 1/2" (12mm) thick.
- U-Wrap screens typically constructed with 2 pieces of PET, some smaller sizes are constructed from 1 piece when possible. See PET Pieces column for specific details.

PET Day-to-Day, Calibrate & E-Series HAT U-Wrap Partial Modesty Under Surface Mount Lite Screens

Material	Where Used	Screen Type	Sized For	Mount Type	Handedness
PET	U-Wrap Partial Modesty on WS	Lite	U-Wrap for Day-to-Day, Calibrate & E-Series HAT	Under Surface Mount	Left or Right

**PET DAY-TO-DAY, CALIBRATE & E-SERIES HAT
U-WRAP PARTIAL MODESTY UNDER SURFACE MOUNT LITE SCREENS**

H	W	D	PET Pieces	Model Number	List
30	42	18	1 PC	Y-5Q4N2U301842B	1,006
30	48	18	1 PC	Y-5Q4N2U301848B	1,037
30	54	18	1 PC	Y-5Q4N2U301854B	1,071
30	60	18	2 PC	Y-5Q4N2U301860B	1,105
30	66	18	2 PC	Y-5Q4N2U301866B	1,139
30	72	18	2 PC	Y-5Q4N2U301872B	1,171
30	78	18	2 PC	Y-5Q4N2U301878B	1,206
30	84	18	2 PC	Y-5Q4N2U301884B	1,239
34	42	18	1 PC	Y-5Q4N2U341842B	950
34	48	18	1 PC	Y-5Q4N2U341848B	988
34	54	18	1 PC	Y-5Q4N2U341854B	1,025
34	60	18	2 PC	Y-5Q4N2U341860B	1,062
34	66	18	2 PC	Y-5Q4N2U341866B	1,100
34	72	18	2 PC	Y-5Q4N2U341872B	1,139
34	78	18	2 PC	Y-5Q4N2U341878B	1,290
34	84	18	2 PC	Y-5Q4N2U341884B	1,328

**PET DAY-TO-DAY, CALIBRATE & E-SERIES HAT
U-WRAP PARTIAL MODESTY UNDER SURFACE MOUNT LITE SCREENS**

H	W	D	PET Pieces	Model Number	List
38	42	18	1 PC	Y-5Q4N2U381842B	994
38	48	18	1 PC	Y-5Q4N2U381848B	1,036
38	54	18	1 PC	Y-5Q4N2U381854B	1,077
38	60	18	2 PC	Y-5Q4N2U381860B	1,122
38	66	18	2 PC	Y-5Q4N2U381866B	1,163
38	72	18	2 PC	Y-5Q4N2U381872B	1,206
38	78	18	2 PC	Y-5Q4N2U381878B	1,374
38	84	18	2 PC	Y-5Q4N2U381884B	1,419
42	42	18	1 PC	Y-5Q4N2U421842B	1,037
42	48	18	1 PC	Y-5Q4N2U421848B	1,086
42	54	18	1 PC	Y-5Q4N2U421854B	1,131
42	60	18	2 PC	Y-5Q4N2U421860B	1,179
42	66	18	2 PC	Y-5Q4N2U421866B	1,224
42	72	18	2 PC	Y-5Q4N2U421872B	1,274
42	78	18	2 PC	Y-5Q4N2U421878B	1,461
42	84	18	2 PC	Y-5Q4N2U421884B	1,508

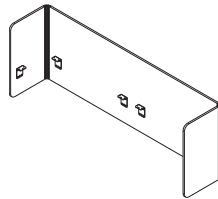

1 PET Piece

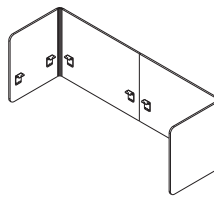

2 PET Pieces

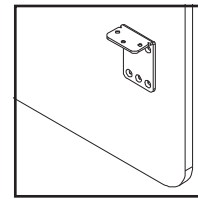

Partial Modesty L-Brackets

Specify

- Paint Selection for Lite Clip
- Color Selection for PET - Lite Grey, Medium Grey, Tan or Vibrant Blue

Notes

- PET U-Wrap Screens are designed to mount to AIS worksurfaces. Specify based on nominal size for the desired system. Order screens that correspond to worksurface width and depth.
- PET screen inserts are 1/2" (12mm) thick.
- U-Wrap screens typically constructed with 2 pieces of PET, some smaller sizes are constructed from 1 piece when possible. See PET Pieces column for specific details.

PET Day-to-Day, Calibrate & E-Series HAT U-Wrap Partial Modesty Under Surface Mount Lite Screens

Material	Where Used	Screen Type	Sized For	Mount Type	Handedness
PET	U-Wrap Partial Modesty on WS	Lite	U-Wrap for Day-to-Day, Calibrate & E-Series HAT	Under Surface Mount	Left or Right

PET DAY-TO-DAY, CALIBRATE & E-SERIES HAT U-WRAP PARTIAL MODESTY UNDER SURFACE MOUNT LITE SCREENS

H	W	D	PET Pieces	Model Number	List
22	42	24	1 PC	Y-5Q4N2U222442B	763
22	48	24	2 PC	Y-5Q4N2U222448B	779
22	54	24	2 PC	Y-5Q4N2U222454B	798
22	60	24	2 PC	Y-5Q4N2U222460B	815
22	66	24	2 PC	Y-5Q4N2U222466B	833
22	72	24	2 PC	Y-5Q4N2U222472B	921
22	78	24	2 PC	Y-5Q4N2U222478B	938
22	84	24	2 PC	Y-5Q4N2U222484B	956
26	42	24	1 PC	Y-5Q4N2U262442B	798
26	48	24	2 PC	Y-5Q4N2U262448B	818
26	54	24	2 PC	Y-5Q4N2U262454B	839
26	60	24	2 PC	Y-5Q4N2U262460B	860
26	66	24	2 PC	Y-5Q4N2U262466B	880
26	72	24	2 PC	Y-5Q4N2U262472B	985
26	78	24	2 PC	Y-5Q4N2U262478B	1,006
26	84	24	2 PC	Y-5Q4N2U262484B	1,026

PET DAY-TO-DAY, CALIBRATE & E-SERIES HAT U-WRAP PARTIAL MODESTY UNDER SURFACE MOUNT LITE SCREENS

H	W	D	PET Pieces	Model Number	List
30	42	24	1 PC	Y-5Q4N2U302442B	1,071
30	48	24	2 PC	Y-5Q4N2U302448B	1,105
30	54	24	2 PC	Y-5Q4N2U302454B	1,139
30	60	24	2 PC	Y-5Q4N2U302460B	1,171
30	66	24	2 PC	Y-5Q4N2U302466B	1,206
30	72	24	2 PC	Y-5Q4N2U302472B	1,239
30	78	24	2 PC	Y-5Q4N2U302478B	1,274
30	84	24	2 PC	Y-5Q4N2U302484B	1,307
34	42	24	1 PC	Y-5Q4N2U342442B	988
34	48	24	2 PC	Y-5Q4N2U342448B	1,025
34	54	24	2 PC	Y-5Q4N2U342454B	1,062
34	60	24	2 PC	Y-5Q4N2U342460B	1,100
34	66	24	2 PC	Y-5Q4N2U342466B	1,139
34	72	24	2 PC	Y-5Q4N2U342472B	1,328
34	78	24	2 PC	Y-5Q4N2U342478B	1,366
34	84	24	2 PC	Y-5Q4N2U342484B	1,404

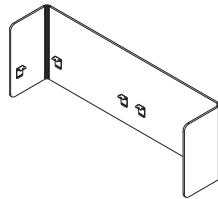

1 PET Piece

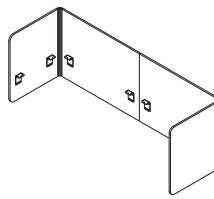

2 PET Pieces

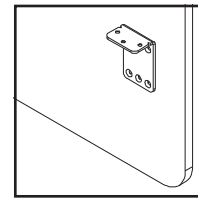

Partial Modesty L-Brackets

Specify

- Paint Selection for Lite Clip
- Color Selection for PET - Lite Grey, Medium Grey, Tan or Vibrant Blue

Notes

- PET U-Wrap Screens are designed to mount to AIS worksurfaces. Specify based on nominal size for the desired system. Order screens that correspond to worksurface width and depth.
- PET screen inserts are 1/2" (12mm) thick.
- U-Wrap screens typically constructed with 2 pieces of PET, some smaller sizes are constructed from 1 piece when possible. See PET Pieces column for specific details.

PET Day-to-Day, Calibrate & E-Series HAT U-Wrap Partial Modesty Under Surface Mount Lite Screens

Material	Where Used	Screen Type	Sized For	Mount Type	Handedness
PET	U-Wrap Partial Modesty on WS	Lite	U-Wrap for Day-to-Day, Calibrate & E-Series HAT	Under Surface Mount	Left or Right

**PET DAY-TO-DAY, CALIBRATE & E-SERIES HAT
U-WRAP PARTIAL MODESTY UNDER SURFACE MOUNT LITE SCREENS**

H	W	D	PET Pieces	Model Number	List
38	42	24	1 PC	Y-5Q4N2U382442B	1,036
38	48	24	2 PC	Y-5Q4N2U382448B	1,077
38	54	24	2 PC	Y-5Q4N2U382454B	1,122
38	60	24	2 PC	Y-5Q4N2U382460B	1,163
38	66	24	2 PC	Y-5Q4N2U382466B	1,206
38	72	24	2 PC	Y-5Q4N2U382472B	1,419
38	78	24	2 PC	Y-5Q4N2U382478B	1,461
38	84	24	2 PC	Y-5Q4N2U382484B	1,503
42	42	24	1 PC	Y-5Q4N2U422442B	1,086
42	48	24	2 PC	Y-5Q4N2U422448B	1,131
42	54	24	2 PC	Y-5Q4N2U422454B	1,179
42	60	24	2 PC	Y-5Q4N2U422460B	1,224
42	66	24	2 PC	Y-5Q4N2U422466B	1,274
42	72	24	2 PC	Y-5Q4N2U422472B	1,508
42	78	24	2 PC	Y-5Q4N2U422478B	1,554
42	84	24	2 PC	Y-5Q4N2U422484B	1,602

**PET DAY-TO-DAY, CALIBRATE & E-SERIES HAT
U-WRAP PARTIAL MODESTY UNDER SURFACE MOUNT LITE SCREENS**

H	W	D	PET Pieces	Model Number	List
22	42	30	2 PC	Y-5Q4N2U223042B	779
22	48	30	2 PC	Y-5Q4N2U223048B	798
22	54	30	2 PC	Y-5Q4N2U223054B	815
22	60	30	2 PC	Y-5Q4N2U223060B	833
22	66	30	2 PC	Y-5Q4N2U223066B	938
22	72	30	2 PC	Y-5Q4N2U223072B	956
22	78	30	2 PC	Y-5Q4N2U223078B	972
22	84	30	2 PC	Y-5Q4N2U223084B	991
26	42	30	2 PC	Y-5Q4N2U263042B	818
26	48	30	2 PC	Y-5Q4N2U263048B	839
26	54	30	2 PC	Y-5Q4N2U263054B	860
26	60	30	2 PC	Y-5Q4N2U263060B	880
26	66	30	2 PC	Y-5Q4N2U263066B	1,006
26	72	30	2 PC	Y-5Q4N2U263072B	1,026
26	78	30	2 PC	Y-5Q4N2U263078B	1,047
26	84	30	2 PC	Y-5Q4N2U263084B	1,066

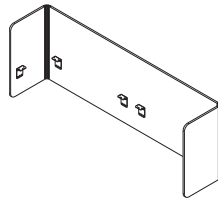

1 PET Piece

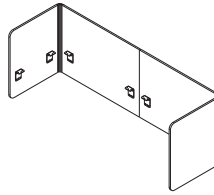

2 PET Pieces

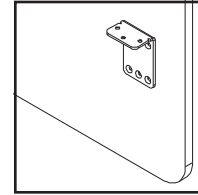

Partial Modesty L-Brackets

Specify

- Paint Selection for Lite Clip
- Color Selection for PET - Lite Grey, Medium Grey, Tan or Vibrant Blue

Notes

- PET U-Wrap Screens are designed to mount to AIS worksurfaces. Specify based on nominal size for the desired system. Order screens that correspond to worksurface width and depth.
- PET screen inserts are 1/2" (12mm) thick.
- U-Wrap screens typically constructed with 2 pieces of PET, some smaller sizes are constructed from 1 piece when possible. See PET Pieces column for specific details.

PET Day-to-Day, Calibrate & E-Series HAT U-Wrap Partial Modesty Under Surface Mount Lite Screens

Material	Where Used	Screen Type	Sized For	Mount Type	Handedness
PET	U-Wrap Partial Modesty on WS	Lite	U-Wrap for Day-to-Day, Calibrate & E-Series HAT	Under Surface Mount	Left or Right

PET DAY-TO-DAY, CALIBRATE & E-SERIES HAT U-WRAP PARTIAL MODESTY UNDER SURFACE MOUNT LITE SCREENS

H	W	D	PET Pieces	Model Number	List
30	42	30	2 PC	Y-5Q4N2U303042B	1,139
30	48	30	2 PC	Y-5Q4N2U303048B	1,171
30	54	30	2 PC	Y-5Q4N2U303054B	1,206
30	60	30	2 PC	Y-5Q4N2U303060B	1,239
30	66	30	2 PC	Y-5Q4N2U303066B	1,274
30	72	30	2 PC	Y-5Q4N2U303072B	1,307
30	78	30	2 PC	Y-5Q4N2U303078B	1,341
30	84	30	2 PC	Y-5Q4N2U303084B	1,373
34	42	30	2 PC	Y-5Q4N2U343042B	1,025
34	48	30	2 PC	Y-5Q4N2U343048B	1,062
34	54	30	2 PC	Y-5Q4N2U343054B	1,100
34	60	30	2 PC	Y-5Q4N2U343060B	1,139
34	66	30	2 PC	Y-5Q4N2U343066B	1,366
34	72	30	2 PC	Y-5Q4N2U343072B	1,404
34	78	30	2 PC	Y-5Q4N2U343078B	1,442
34	84	30	2 PC	Y-5Q4N2U343084B	1,480

PET DAY-TO-DAY, CALIBRATE & E-SERIES HAT U-WRAP PARTIAL MODESTY UNDER SURFACE MOUNT LITE SCREENS

H	W	D	PET Pieces	Model Number	List
38	42	30	2 PC	Y-5Q4N2U383042B	1,077
38	48	30	2 PC	Y-5Q4N2U383048B	1,122
38	54	30	2 PC	Y-5Q4N2U383054B	1,163
38	60	30	2 PC	Y-5Q4N2U383060B	1,206
38	66	30	2 PC	Y-5Q4N2U383066B	1,461
38	72	30	2 PC	Y-5Q4N2U383072B	1,503
38	78	30	2 PC	Y-5Q4N2U383078B	1,545
38	84	30	2 PC	Y-5Q4N2U383084B	1,586
42	42	30	2 PC	Y-5Q4N2U423042B	1,131
42	48	30	2 PC	Y-5Q4N2U423048B	1,179
42	54	30	2 PC	Y-5Q4N2U423054B	1,224
42	60	30	2 PC	Y-5Q4N2U423060B	1,274
42	66	30	2 PC	Y-5Q4N2U423066B	1,554
42	72	30	2 PC	Y-5Q4N2U423072B	1,602
42	78	30	2 PC	Y-5Q4N2U423078B	1,647
42	84	30	2 PC	Y-5Q4N2U423084B	1,694

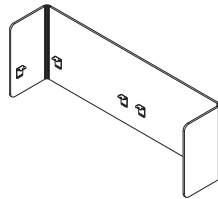

1 PET Piece

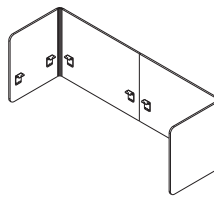

2 PET Pieces

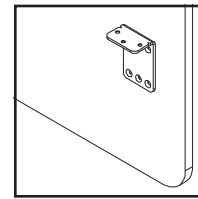

Partial Modesty L-Brackets

Specify

- Paint Selection for Lite Clip
- Color Selection for PET - Lite Grey, Medium Grey, Tan or Vibrant Blue

Notes

- PET U-Wrap Screens are designed to mount to AIS worksurfaces. Specify based on nominal size for the desired system. Order screens that correspond to worksurface width and depth.
- PET screen inserts are 1/2" (12mm) thick.
- U-Wrap screens typically constructed with 2 pieces of PET, some smaller sizes are constructed from 1 piece when possible. See PET Pieces column for specific details.

PET Day-to-Day, Calibrate & E-Series HAT U-Wrap Partial Modesty Under Surface Mount Lite Screens

Material	Where Used	Screen Type	Sized For	Mount Type	Handedness
PET	U-Wrap Partial Modesty on WS	Lite	U-Wrap for Day-to-Day, Calibrate & E-Series HAT	Under Surface Mount	Left or Right

**PET DAY-TO-DAY, CALIBRATE & E-SERIES HAT
U-WRAP PARTIAL MODESTY UNDER SURFACE MOUNT LITE SCREENS**

H	W	D	PET Pieces	Model Number	List
22	42	36	2 PC	Y-5Q4N2U223642B	798
22	48	36	2 PC	Y-5Q4N2U223648B	815
22	54	36	2 PC	Y-5Q4N2U223654B	833
22	60	36	2 PC	Y-5Q4N2U223660B	956
22	66	36	2 PC	Y-5Q4N2U223666B	972
22	72	36	2 PC	Y-5Q4N2U223672B	991
22	78	36	2 PC	Y-5Q4N2U223678B	1,008
22	84	36	2 PC	Y-5Q4N2U223684B	1,026
26	42	36	2 PC	Y-5Q4N2U263642B	839
26	48	36	2 PC	Y-5Q4N2U263648B	860
26	54	36	2 PC	Y-5Q4N2U263654B	880
26	60	36	2 PC	Y-5Q4N2U263660B	1,026
26	66	36	2 PC	Y-5Q4N2U263666B	1,047
26	72	36	2 PC	Y-5Q4N2U263672B	1,066
26	78	36	2 PC	Y-5Q4N2U263678B	1,088
26	84	36	2 PC	Y-5Q4N2U263684B	1,107

**PET DAY-TO-DAY, CALIBRATE & E-SERIES HAT
U-WRAP PARTIAL MODESTY UNDER SURFACE MOUNT LITE SCREENS**

H	W	D	PET Pieces	Model Number	List
30	42	36	2 PC	Y-5Q4N2U303642B	1,206
30	48	36	2 PC	Y-5Q4N2U303648B	1,239
30	54	36	2 PC	Y-5Q4N2U303654B	1,274
30	60	36	2 PC	Y-5Q4N2U303660B	1,307
30	66	36	2 PC	Y-5Q4N2U303666B	1,341
30	72	36	2 PC	Y-5Q4N2U303672B	1,373
30	78	36	2 PC	Y-5Q4N2U303678B	1,406
30	84	36	2 PC	Y-5Q4N2U303684B	1,440
34	42	36	2 PC	Y-5Q4N2U343642B	1,062
34	48	36	2 PC	Y-5Q4N2U343648B	1,100
34	54	36	2 PC	Y-5Q4N2U343654B	1,139
34	60	36	2 PC	Y-5Q4N2U343660B	1,404
34	66	36	2 PC	Y-5Q4N2U343666B	1,442
34	72	36	2 PC	Y-5Q4N2U343672B	1,480
34	78	36	2 PC	Y-5Q4N2U343678B	1,517
34	84	36	2 PC	Y-5Q4N2U343684B	1,555

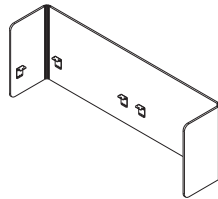

1 PET Piece

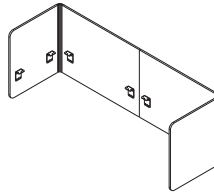

2 PET Pieces

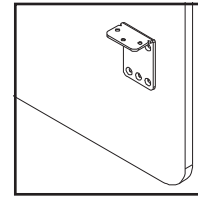

Partial Modesty L-Brackets

Specify

- Paint Selection for Lite Clip
- Color Selection for PET - Lite Grey, Medium Grey, Tan or Vibrant Blue

Notes

- PET U-Wrap Screens are designed to mount to AIS worksurfaces. Specify based on nominal size for the desired system. Order screens that correspond to worksurface width and depth.
- PET screen inserts are 1/2" (12mm) thick.
- U-Wrap screens typically constructed with 2 pieces of PET, some smaller sizes are constructed from 1 piece when possible. See PET Pieces column for specific details.

PET Day-to-Day, Calibrate & E-Series HAT U-Wrap Partial Modesty Under Surface Mount Lite Screens

Material	Where Used	Screen Type	Sized For	Mount Type	Handedness
PET	U-Wrap Partial Modesty on WS	Lite	U-Wrap for Day-to-Day, Calibrate & E-Series HAT	Under Surface Mount	Left or Right

PET DAY-TO-DAY, CALIBRATE & E-SERIES HAT U-WRAP PARTIAL MODESTY UNDER SURFACE MOUNT LITE SCREENS

H	W	D	PET Pieces	Model Number	List
38	42	36	2 PC	Y-5Q4N2U383642B	1,122
38	48	36	2 PC	Y-5Q4N2U383648B	1,163
38	54	36	2 PC	Y-5Q4N2U383654B	1,206
38	60	36	2 PC	Y-5Q4N2U383660B	1,503
38	66	36	2 PC	Y-5Q4N2U383666B	1,545
38	72	36	2 PC	Y-5Q4N2U383672B	1,586
38	78	36	2 PC	Y-5Q4N2U383678B	1,629
38	84	36	2 PC	Y-5Q4N2U383684B	1,672
42	42	36	2 PC	Y-5Q4N2U423642B	1,179
42	48	36	2 PC	Y-5Q4N2U423648B	1,224
42	54	36	2 PC	Y-5Q4N2U423654B	1,274
42	60	36	2 PC	Y-5Q4N2U423660B	1,602
42	66	36	2 PC	Y-5Q4N2U423666B	1,647
42	72	36	2 PC	Y-5Q4N2U423672B	1,694
42	78	36	2 PC	Y-5Q4N2U423678B	1,741
42	84	36	2 PC	Y-5Q4N2U423684B	1,788

PET DAY-TO-DAY, CALIBRATE & E-SERIES HAT U-WRAP PARTIAL MODESTY UNDER SURFACE MOUNT LITE SCREENS

H	W	D	PET Pieces	Model Number	List
22	42	42	2 PC	Y-5Q4N2U224242B	815
22	48	42	2 PC	Y-5Q4N2U224248B	833
22	54	42	2 PC	Y-5Q4N2U224254B	972
22	60	42	2 PC	Y-5Q4N2U224260B	991
22	66	42	2 PC	Y-5Q4N2U224266B	1,008
22	72	42	2 PC	Y-5Q4N2U224272B	1,026
22	78	42	2 PC	Y-5Q4N2U224278B	1,043
22	84	42	2 PC	Y-5Q4N2U224284B	1,061
26	42	42	2 PC	Y-5Q4N2U264242B	860
26	48	42	2 PC	Y-5Q4N2U264248B	880
26	54	42	2 PC	Y-5Q4N2U264254B	1,047
26	60	42	2 PC	Y-5Q4N2U264260B	1,066
26	66	42	2 PC	Y-5Q4N2U264266B	1,088
26	72	42	2 PC	Y-5Q4N2U264272B	1,107
26	78	42	2 PC	Y-5Q4N2U264278B	1,129
26	84	42	2 PC	Y-5Q4N2U264284B	1,150

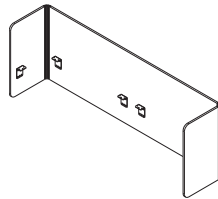

1 PET Piece

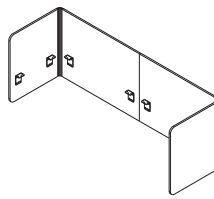

2 PET Pieces

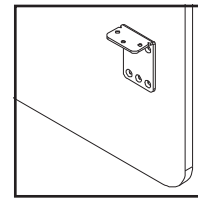

Partial Modesty L-Brackets

Specify

- Paint Selection for Lite Clip
- Color Selection for PET - Lite Grey, Medium Grey, Tan or Vibrant Blue

Notes

- PET U-Wrap Screens are designed to mount to AIS worksurfaces. Specify based on nominal size for the desired system. Order screens that correspond to worksurface width and depth.
- PET screen inserts are 1/2" (12mm) thick.
- U-Wrap screens typically constructed with 2 pieces of PET, some smaller sizes are constructed from 1 piece when possible. See PET Pieces column for specific details.

PET Day-to-Day, Calibrate & E-Series HAT U-Wrap Partial Modesty Under Surface Mount Lite Screens

Material	Where Used	Screen Type	Sized For	Mount Type	Handedness
PET	U-Wrap Partial Modesty on WS	Lite	U-Wrap for Day-to-Day, Calibrate & E-Series HAT	Under Surface Mount	Left or Right

**PET DAY-TO-DAY, CALIBRATE & E-SERIES HAT
U-WRAP PARTIAL MODESTY UNDER SURFACE MOUNT LITE SCREENS**

H	W	D	PET Pieces	Model Number	List
30	42	42	2 PC	Y-5Q4N2U304242B	1,274
30	48	42	2 PC	Y-5Q4N2U304248B	1,307
30	54	42	2 PC	Y-5Q4N2U304254B	1,341
30	60	42	2 PC	Y-5Q4N2U304260B	1,373
30	66	42	2 PC	Y-5Q4N2U304266B	1,406
30	72	42	2 PC	Y-5Q4N2U304272B	1,440
30	78	42	2 PC	Y-5Q4N2U304278B	1,474
30	84	42	2 PC	Y-5Q4N2U304284B	1,508
34	42	42	2 PC	Y-5Q4N2U344242B	1,100
34	48	42	2 PC	Y-5Q4N2U344248B	1,139
34	54	42	2 PC	Y-5Q4N2U344254B	1,442
34	60	42	2 PC	Y-5Q4N2U344260B	1,480
34	66	42	2 PC	Y-5Q4N2U344266B	1,517
34	72	42	2 PC	Y-5Q4N2U344272B	1,555
34	78	42	2 PC	Y-5Q4N2U344278B	1,593
34	84	42	2 PC	Y-5Q4N2U344284B	1,631

**PET DAY-TO-DAY, CALIBRATE & E-SERIES HAT
U-WRAP PARTIAL MODESTY UNDER SURFACE MOUNT LITE SCREENS**

H	W	D	PET Pieces	Model Number	List
38	42	42	2 PC	Y-5Q4N2U384242B	1,163
38	48	42	2 PC	Y-5Q4N2U384248B	1,206
38	54	42	2 PC	Y-5Q4N2U384254B	1,545
38	60	42	2 PC	Y-5Q4N2U384260B	1,586
38	66	42	2 PC	Y-5Q4N2U384266B	1,629
38	72	42	2 PC	Y-5Q4N2U384272B	1,672
38	78	42	2 PC	Y-5Q4N2U384278B	1,714
38	84	42	2 PC	Y-5Q4N2U384284B	1,757
42	42	42	2 PC	Y-5Q4N2U424242B	1,224
42	48	42	2 PC	Y-5Q4N2U424248B	1,274
42	54	42	2 PC	Y-5Q4N2U424254B	1,647
42	60	42	2 PC	Y-5Q4N2U424260B	1,694
42	66	42	2 PC	Y-5Q4N2U424266B	1,741
42	72	42	2 PC	Y-5Q4N2U424272B	1,788
42	78	42	2 PC	Y-5Q4N2U424278B	1,835
42	84	42	2 PC	Y-5Q4N2U424284B	1,882

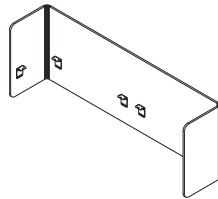

1 PET Piece

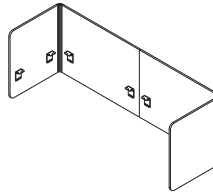

2 PET Pieces

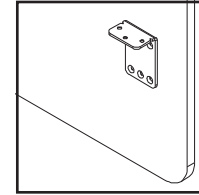

Partial Modesty L-Brackets

Specify

- Paint Selection for Lite Clip
- Color Selection for PET - Lite Grey, Medium Grey, Tan or Vibrant Blue

Notes

- PET U-Wrap Screens are designed to mount to AIS worksurfaces. Specify based on nominal size for the desired system. Order screens that correspond to worksurface width and depth.
- PET screen inserts are 1/2" (12mm) thick.
- U-Wrap screens typically constructed with 2 pieces of PET, some smaller sizes are constructed from 1 piece when possible. See PET Pieces column for specific details.

U-Wrap Screens Sized for Nominal = Actual Size

PET Nominal = Actual Size U-Wrap Under Surface Mount Lite Screens

Material	Where Used	Screen Type	Sized For	Mount Type
PET	U-Wrap on Worksurface	Lite	U-Wrap for Nominal = Actual Size	Under Surface Mount

**PET NOMINAL = ACTUAL SIZE
U-WRAP UNDER SURFACE MOUNT LITE SCREENS**

H	W	D	PET Pieces	Model Number	List
12	42	12	1	Y-5N4Q2U121242B	656
12	48	12	1	Y-5N4Q2U121248B	666
12	54	12	1	Y-5N4Q2U121254B	675
12	60	12	1	Y-5N4Q2U121260B	684
12	66	12	1	Y-5N4Q2U121266B	695
12	72	12	2	Y-5N4Q2U121272B	704
12	78	12	2	Y-5N4Q2U121278B	713
12	84	12	2	Y-5N4Q2U121284B	742
16	42	12	1	Y-5N4Q2U161242B	684
16	48	12	1	Y-5N4Q2U161248B	697
16	54	12	1	Y-5N4Q2U161254B	710
16	60	12	1	Y-5N4Q2U161260B	724
16	66	12	1	Y-5N4Q2U161266B	736
16	72	12	2	Y-5N4Q2U161272B	748
16	78	12	2	Y-5N4Q2U161278B	761
16	84	12	2	Y-5N4Q2U161284B	800

**PET NOMINAL = ACTUAL SIZE
U-WRAP UNDER SURFACE MOUNT LITE SCREENS**

H	W	D	PET Pieces	Model Number	List
20	42	12	1	Y-5N4Q2U201242B	713
20	48	12	1	Y-5N4Q2U201248B	729
20	54	12	1	Y-5N4Q2U201254B	746
20	60	12	1	Y-5N4Q2U201260B	761
20	66	12	1	Y-5N4Q2U201266B	776
20	72	12	2	Y-5N4Q2U201272B	794
20	78	12	2	Y-5N4Q2U201278B	808
20	84	12	2	Y-5N4Q2U201284B	858
24	42	12	1	Y-5N4Q2U241242B	740
24	48	12	1	Y-5N4Q2U241248B	761
24	54	12	1	Y-5N4Q2U241254B	779
24	60	12	1	Y-5N4Q2U241260B	800
24	66	12	1	Y-5N4Q2U241266B	818
24	72	12	2	Y-5N4Q2U241272B	837
24	78	12	2	Y-5N4Q2U241278B	858
24	84	12	2	Y-5N4Q2U241284B	914

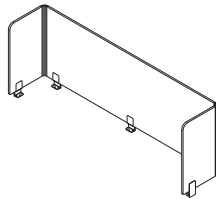

1 PET Piece

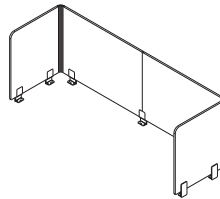

2 PET Pieces

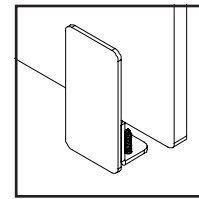

Under Surface Mount Lite

Specify

- Paint Selection for Lite Clip
- Color Selection for PET - Lite Grey, Medium Grey, Tan or Vibrant Blue

Notes

- PET U-Wrap Screens are designed to mount to AIS worksurfaces. Specify based on nominal size for the desired system. Order screens that correspond to worksurface width and depth.
- PET screen inserts are 1/2" (12mm) thick.
- U-Wrap screens typically constructed with 2 pieces of PET, some smaller sizes are constructed from 1 piece when possible. See PET Pieces column for specific details.

PET Nominal = Actual Size U-Wrap Under Surface Mount Lite Screens

Material	Where Used	Screen Type	Sized For	Mount Type
PET	U-Wrap on Worksurface	Lite	U-Wrap for Nominal = Actual Size	Under Surface Mount

PET NOMINAL = ACTUAL SIZE U-WRAP UNDER SURFACE MOUNT LITE SCREENS

H	W	D	PET Pieces	Model Number	List
28	42	12	1	Y-5N4Q2U281242B	769
28	48	12	1	Y-5N4Q2U281248B	794
28	54	12	1	Y-5N4Q2U281254B	815
28	60	12	1	Y-5N4Q2U281260B	837
28	66	12	1	Y-5N4Q2U281266B	860
28	72	12	2	Y-5N4Q2U281272B	881
28	78	12	2	Y-5N4Q2U281278B	904
28	84	12	2	Y-5N4Q2U281284B	971
32	42	12	1	Y-5N4Q2U321242B	890
32	48	12	1	Y-5N4Q2U321248B	927
32	54	12	1	Y-5N4Q2U321254B	962
32	60	12	1	Y-5N4Q2U321260B	997
32	66	12	1	Y-5N4Q2U321266B	1,033
32	72	12	2	Y-5N4Q2U321272B	1,069
32	78	12	2	Y-5N4Q2U321278B	1,105
32	84	12	2	Y-5N4Q2U321284B	1,213

PET NOMINAL = ACTUAL SIZE U-WRAP UNDER SURFACE MOUNT LITE SCREENS

H	W	D	PET Pieces	Model Number	List
12	42	18	1	Y-5N4Q2U121842B	666
12	48	18	1	Y-5N4Q2U121848B	675
12	54	18	1	Y-5N4Q2U121854B	684
12	60	18	2	Y-5N4Q2U121860B	695
12	66	18	2	Y-5N4Q2U121866B	704
12	72	18	2	Y-5N4Q2U121872B	713
12	78	18	2	Y-5N4Q2U121878B	753
12	84	18	2	Y-5N4Q2U121884B	763
16	42	18	1	Y-5N4Q2U161842B	697
16	48	18	1	Y-5N4Q2U161848B	710
16	54	18	1	Y-5N4Q2U161854B	724
16	60	18	2	Y-5N4Q2U161860B	736
16	66	18	2	Y-5N4Q2U161866B	748
16	72	18	2	Y-5N4Q2U161872B	761
16	78	18	2	Y-5N4Q2U161878B	813
16	84	18	2	Y-5N4Q2U161884B	827

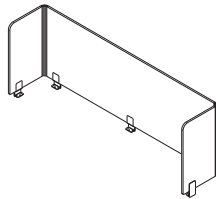

1 PET Piece

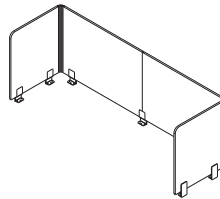

2 PET Pieces

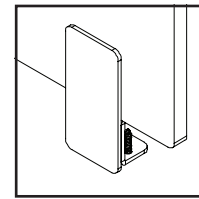

Under Surface Mount Lite

Specify

- Paint Selection for Lite Clip
- Color Selection for PET - Lite Grey, Medium Grey, Tan or Vibrant Blue

Notes

- PET U-Wrap Screens are designed to mount to AIS worksurfaces. Specify based on nominal size for the desired system. Order screens that correspond to worksurface width and depth.
- PET screen inserts are 1/2" (12mm) thick.
- U-Wrap screens typically constructed with 2 pieces of PET, some smaller sizes are constructed from 1 piece when possible. See PET Pieces column for specific details.

PET Nominal = Actual Size U-Wrap Under Surface Mount Lite Screens

Material	Where Used	Screen Type	Sized For	Mount Type
PET	U-Wrap on Worksurface	Lite	U-Wrap for Nominal = Actual Size	Under Surface Mount

**PET NOMINAL = ACTUAL SIZE
U-WRAP UNDER SURFACE MOUNT LITE SCREENS**

H	W	D	PET Pieces	Model Number	List
20	42	18	1	Y-5N4Q2U201842B	729
20	48	18	1	Y-5N4Q2U201848B	746
20	54	18	1	Y-5N4Q2U201854B	761
20	60	18	2	Y-5N4Q2U201860B	776
20	66	18	2	Y-5N4Q2U201866B	794
20	72	18	2	Y-5N4Q2U201872B	808
20	78	18	2	Y-5N4Q2U201878B	873
20	84	18	2	Y-5N4Q2U201884B	889
24	42	18	1	Y-5N4Q2U241842B	761
24	48	18	1	Y-5N4Q2U241848B	779
24	54	18	1	Y-5N4Q2U241854B	800
24	60	18	2	Y-5N4Q2U241860B	818
24	66	18	2	Y-5N4Q2U241866B	837
24	72	18	2	Y-5N4Q2U241872B	858
24	78	18	2	Y-5N4Q2U241878B	935
24	84	18	2	Y-5N4Q2U241884B	954

**PET NOMINAL = ACTUAL SIZE
U-WRAP UNDER SURFACE MOUNT LITE SCREENS**

H	W	D	PET Pieces	Model Number	List
28	42	18	1	Y-5N4Q2U281842B	794
28	48	18	1	Y-5N4Q2U281848B	815
28	54	18	1	Y-5N4Q2U281854B	837
28	60	18	2	Y-5N4Q2U281860B	860
28	66	18	2	Y-5N4Q2U281866B	881
28	72	18	2	Y-5N4Q2U281872B	904
28	78	18	2	Y-5N4Q2U281878B	995
28	84	18	2	Y-5N4Q2U281884B	1,018
32	42	18	1	Y-5N4Q2U321842B	927
32	48	18	1	Y-5N4Q2U321848B	962
32	54	18	1	Y-5N4Q2U321854B	997
32	60	18	2	Y-5N4Q2U321860B	1,033
32	66	18	2	Y-5N4Q2U321866B	1,069
32	72	18	2	Y-5N4Q2U321872B	1,105
32	78	18	2	Y-5N4Q2U321878B	1,249
32	84	18	2	Y-5N4Q2U321884B	1,285

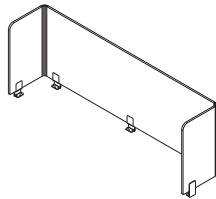

1 PET Piece

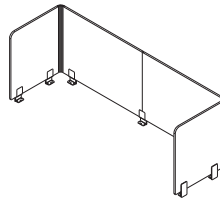

2 PET Pieces

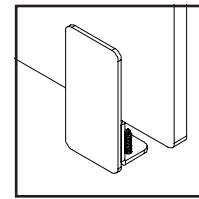

Under Surface Mount Lite

Specify

- Paint Selection for Lite Clip
- Color Selection for PET - Lite Grey, Medium Grey, Tan or Vibrant Blue

Notes

- PET U-Wrap Screens are designed to mount to AIS worksurfaces. Specify based on nominal size for the desired system. Order screens that correspond to worksurface width and depth.
- PET screen inserts are 1/2" (12mm) thick.
- U-Wrap screens typically constructed with 2 pieces of PET, some smaller sizes are constructed from 1 piece when possible. See PET Pieces column for specific details.

PET Nominal = Actual Size U-Wrap Under Surface Mount Lite Screens

Material	Where Used	Screen Type	Sized For	Mount Type
PET	U-Wrap on Worksurface	Lite	U-Wrap for Nominal = Actual Size	Under Surface Mount

PET NOMINAL = ACTUAL SIZE U-WRAP UNDER SURFACE MOUNT LITE SCREENS

H	W	D	PET Pieces	Model Number	List
12	42	24	1	Y-5N4Q2U122442B	675
12	48	24	2	Y-5N4Q2U122448B	684
12	54	24	2	Y-5N4Q2U122454B	695
12	60	24	2	Y-5N4Q2U122460B	704
12	66	24	2	Y-5N4Q2U122466B	713
12	72	24	2	Y-5N4Q2U122472B	763
12	78	24	2	Y-5N4Q2U122478B	771
12	84	24	2	Y-5N4Q2U122484B	779
16	42	24	1	Y-5N4Q2U162442B	710
16	48	24	2	Y-5N4Q2U162448B	724
16	54	24	2	Y-5N4Q2U162454B	736
16	60	24	2	Y-5N4Q2U162460B	748
16	66	24	2	Y-5N4Q2U162466B	761
16	72	24	2	Y-5N4Q2U162472B	827
16	78	24	2	Y-5N4Q2U162478B	837
16	84	24	2	Y-5N4Q2U162484B	850

PET NOMINAL = ACTUAL SIZE U-WRAP UNDER SURFACE MOUNT LITE SCREENS

H	W	D	PET Pieces	Model Number	List
20	42	24	1	Y-5N4Q2U202442B	746
20	48	24	2	Y-5N4Q2U202448B	761
20	54	24	2	Y-5N4Q2U202454B	776
20	60	24	2	Y-5N4Q2U202460B	794
20	66	24	2	Y-5N4Q2U202466B	808
20	72	24	2	Y-5N4Q2U202472B	889
20	78	24	2	Y-5N4Q2U202478B	906
20	84	24	2	Y-5N4Q2U202484B	921
24	42	24	1	Y-5N4Q2U242442B	779
24	48	24	2	Y-5N4Q2U242448B	800
24	54	24	2	Y-5N4Q2U242454B	818
24	60	24	2	Y-5N4Q2U242460B	837
24	66	24	2	Y-5N4Q2U242466B	858
24	72	24	2	Y-5N4Q2U242472B	954
24	78	24	2	Y-5N4Q2U242478B	971
24	84	24	2	Y-5N4Q2U242484B	991

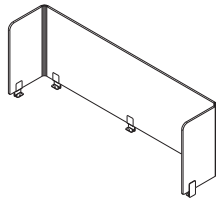

1 PET Piece

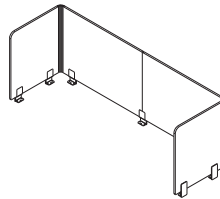

2 PET Pieces

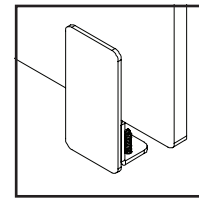

Under Surface Mount Lite

Specify

- Paint Selection for Lite Clip
- Color Selection for PET - Lite Grey, Medium Grey, Tan or Vibrant Blue

Notes

- PET U-Wrap Screens are designed to mount to AIS worksurfaces. Specify based on nominal size for the desired system. Order screens that correspond to worksurface width and depth.
- PET screen inserts are 1/2" (12mm) thick.
- U-Wrap screens typically constructed with 2 pieces of PET, some smaller sizes are constructed from 1 piece when possible. See PET Pieces column for specific details.

PET Nominal = Actual Size U-Wrap Under Surface Mount Lite Screens

Material	Where Used	Screen Type	Sized For	Mount Type
PET	U-Wrap on Worksurface	Lite	U-Wrap for Nominal = Actual Size	Under Surface Mount

**PET NOMINAL = ACTUAL SIZE
U-WRAP UNDER SURFACE MOUNT LITE SCREENS**

H	W	D	PET Pieces	Model Number	List
28	42	24	1	Y-5N4Q2U282442B	815
28	48	24	2	Y-5N4Q2U282448B	837
28	54	24	2	Y-5N4Q2U282454B	860
28	60	24	2	Y-5N4Q2U282460B	881
28	66	24	2	Y-5N4Q2U282466B	904
28	72	24	2	Y-5N4Q2U282472B	1,018
28	78	24	2	Y-5N4Q2U282478B	1,038
28	84	24	2	Y-5N4Q2U282484B	1,061
32	42	24	1	Y-5N4Q2U322442B	962
32	48	24	2	Y-5N4Q2U322448B	997
32	54	24	2	Y-5N4Q2U322454B	1,033
32	60	24	2	Y-5N4Q2U322460B	1,069
32	66	24	2	Y-5N4Q2U322466B	1,105
32	72	24	2	Y-5N4Q2U322472B	1,285
32	78	24	2	Y-5N4Q2U322478B	1,320
32	84	24	2	Y-5N4Q2U322484B	1,355

**PET NOMINAL = ACTUAL SIZE
U-WRAP UNDER SURFACE MOUNT LITE SCREENS**

H	W	D	PET Pieces	Model Number	List
12	42	30	2	Y-5N4Q2U123042B	684
12	48	30	2	Y-5N4Q2U123048B	695
12	54	30	2	Y-5N4Q2U123054B	704
12	60	30	2	Y-5N4Q2U123060B	713
12	66	30	2	Y-5N4Q2U123066B	771
12	72	30	2	Y-5N4Q2U123072B	779
12	78	30	2	Y-5N4Q2U123078B	791
12	84	30	2	Y-5N4Q2U123084B	800
16	42	30	2	Y-5N4Q2U163042B	724
16	48	30	2	Y-5N4Q2U163048B	736
16	54	30	2	Y-5N4Q2U163054B	748
16	60	30	2	Y-5N4Q2U163060B	761
16	66	30	2	Y-5N4Q2U163066B	837
16	72	30	2	Y-5N4Q2U163072B	850
16	78	30	2	Y-5N4Q2U163078B	864
16	84	30	2	Y-5N4Q2U163084B	876

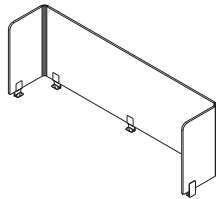

1 PET Piece

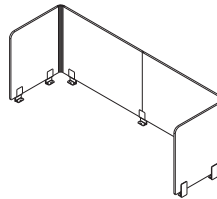

2 PET Pieces

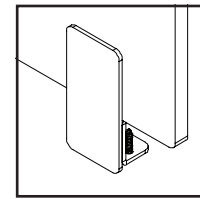

Under Surface Mount Lite

Specify

- Paint Selection for Lite Clip
- Color Selection for PET - Lite Grey, Medium Grey, Tan or Vibrant Blue

Notes

- PET U-Wrap Screens are designed to mount to AIS worksurfaces. Specify based on nominal size for the desired system. Order screens that correspond to worksurface width and depth.
- PET screen inserts are 1/2" (12mm) thick.
- U-Wrap screens typically constructed with 2 pieces of PET, some smaller sizes are constructed from 1 piece when possible. See PET Pieces column for specific details.

PET Nominal = Actual Size U-Wrap Under Surface Mount Lite Screens

Material	Where Used	Screen Type	Sized For	Mount Type
PET	U-Wrap on Worksurface	Lite	U-Wrap for Nominal = Actual Size	Under Surface Mount

PET NOMINAL = ACTUAL SIZE U-WRAP UNDER SURFACE MOUNT LITE SCREENS

H	W	D	PET Pieces	Model Number	List
20	42	30	2	Y-5N4Q2U203042B	761
20	48	30	2	Y-5N4Q2U203048B	776
20	54	30	2	Y-5N4Q2U203054B	794
20	60	30	2	Y-5N4Q2U203060B	808
20	66	30	2	Y-5N4Q2U203066B	906
20	72	30	2	Y-5N4Q2U203072B	921
20	78	30	2	Y-5N4Q2U203078B	937
20	84	30	2	Y-5N4Q2U203084B	954
24	42	30	2	Y-5N4Q2U243042B	800
24	48	30	2	Y-5N4Q2U243048B	818
24	54	30	2	Y-5N4Q2U243054B	837
24	60	30	2	Y-5N4Q2U243060B	858
24	66	30	2	Y-5N4Q2U243066B	971
24	72	30	2	Y-5N4Q2U243072B	991
24	78	30	2	Y-5N4Q2U243078B	1,010
24	84	30	2	Y-5N4Q2U243084B	1,029

PET NOMINAL = ACTUAL SIZE U-WRAP UNDER SURFACE MOUNT LITE SCREENS

H	W	D	PET Pieces	Model Number	List
28	42	30	2	Y-5N4Q2U283042B	837
28	48	30	2	Y-5N4Q2U283048B	860
28	54	30	2	Y-5N4Q2U283054B	881
28	60	30	2	Y-5N4Q2U283060B	904
28	66	30	2	Y-5N4Q2U283066B	1,038
28	72	30	2	Y-5N4Q2U283072B	1,061
28	78	30	2	Y-5N4Q2U283078B	1,085
28	84	30	2	Y-5N4Q2U283084B	1,105
32	42	30	2	Y-5N4Q2U323042B	997
32	48	30	2	Y-5N4Q2U323048B	1,033
32	54	30	2	Y-5N4Q2U323054B	1,069
32	60	30	2	Y-5N4Q2U323060B	1,105
32	66	30	2	Y-5N4Q2U323066B	1,320
32	72	30	2	Y-5N4Q2U323072B	1,355
32	78	30	2	Y-5N4Q2U323078B	1,392
32	84	30	2	Y-5N4Q2U323084B	1,426

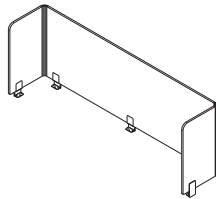

1 PET Piece

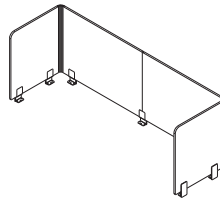

2 PET Pieces

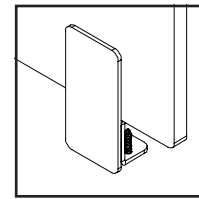

Under Surface Mount Lite

Specify

- Paint Selection for Lite Clip
- Color Selection for PET - Lite Grey, Medium Grey, Tan or Vibrant Blue

Notes

- PET U-Wrap Screens are designed to mount to AIS worksurfaces. Specify based on nominal size for the desired system. Order screens that correspond to worksurface width and depth.
- PET screen inserts are 1/2" (12mm) thick.
- U-Wrap screens typically constructed with 2 pieces of PET, some smaller sizes are constructed from 1 piece when possible. See PET Pieces column for specific details.

PET Nominal = Actual Size U-Wrap Under Surface Mount Lite Screens

Material	Where Used	Screen Type	Sized For	Mount Type
PET	U-Wrap on Worksurface	Lite	U-Wrap for Nominal = Actual Size	Under Surface Mount

**PET NOMINAL = ACTUAL SIZE
U-WRAP UNDER SURFACE MOUNT LITE SCREENS**

H	W	D	PET Pieces	Model Number	List
12	42	36	2	Y-5N4Q2U123642B	695
12	48	36	2	Y-5N4Q2U123648B	704
12	54	36	2	Y-5N4Q2U123654B	713
12	60	36	2	Y-5N4Q2U123660B	779
12	66	36	2	Y-5N4Q2U123666B	791
12	72	36	2	Y-5N4Q2U123672B	800
12	78	36	2	Y-5N4Q2U123678B	808
12	84	36	2	Y-5N4Q2U123684B	820
16	42	36	2	Y-5N4Q2U163642B	736
16	48	36	2	Y-5N4Q2U163648B	748
16	54	36	2	Y-5N4Q2U163654B	761
16	60	36	2	Y-5N4Q2U163660B	850
16	66	36	2	Y-5N4Q2U163666B	864
16	72	36	2	Y-5N4Q2U163672B	876
16	78	36	2	Y-5N4Q2U163678B	889
16	84	36	2	Y-5N4Q2U163684B	901

**PET NOMINAL = ACTUAL SIZE
U-WRAP UNDER SURFACE MOUNT LITE SCREENS**

H	W	D	PET Pieces	Model Number	List
20	42	36	2	Y-5N4Q2U203642B	776
20	48	36	2	Y-5N4Q2U203648B	794
20	54	36	2	Y-5N4Q2U203654B	808
20	60	36	2	Y-5N4Q2U203660B	921
20	66	36	2	Y-5N4Q2U203666B	937
20	72	36	2	Y-5N4Q2U203672B	954
20	78	36	2	Y-5N4Q2U203678B	969
20	84	36	2	Y-5N4Q2U203684B	985
24	42	36	2	Y-5N4Q2U243642B	818
24	48	36	2	Y-5N4Q2U243648B	837
24	54	36	2	Y-5N4Q2U243654B	858
24	60	36	2	Y-5N4Q2U243660B	991
24	66	36	2	Y-5N4Q2U243666B	1,010
24	72	36	2	Y-5N4Q2U243672B	1,029
24	78	36	2	Y-5N4Q2U243678B	1,049
24	84	36	2	Y-5N4Q2U243684B	1,068

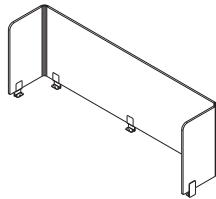

1 PET Piece

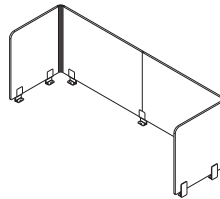

2 PET Pieces

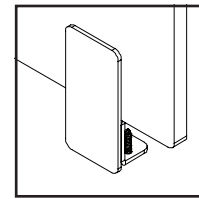

Under Surface Mount Lite

Specify

- Paint Selection for Lite Clip
- Color Selection for PET - Lite Grey, Medium Grey, Tan or Vibrant Blue

Notes

- PET U-Wrap Screens are designed to mount to AIS worksurfaces. Specify based on nominal size for the desired system. Order screens that correspond to worksurface width and depth.
- PET screen inserts are 1/2" (12mm) thick.
- U-Wrap screens typically constructed with 2 pieces of PET, some smaller sizes are constructed from 1 piece when possible. See PET Pieces column for specific details.

PET Nominal = Actual Size U-Wrap Under Surface Mount Lite Screens

Material	Where Used	Screen Type	Sized For	Mount Type
PET	U-Wrap on Worksurface	Lite	U-Wrap for Nominal = Actual Size	Under Surface Mount

PET NOMINAL = ACTUAL SIZE U-WRAP UNDER SURFACE MOUNT LITE SCREENS

H	W	D	PET Pieces	Model Number	List
28	42	36	2	Y-5N4Q2U283642B	860
28	48	36	2	Y-5N4Q2U283648B	881
28	54	36	2	Y-5N4Q2U283654B	904
28	60	36	2	Y-5N4Q2U283660B	1,061
28	66	36	2	Y-5N4Q2U283666B	1,085
28	72	36	2	Y-5N4Q2U283672B	1,105
28	78	36	2	Y-5N4Q2U283678B	1,128
28	84	36	2	Y-5N4Q2U283684B	1,151
32	42	36	2	Y-5N4Q2U323642B	1,033
32	48	36	2	Y-5N4Q2U323648B	1,069
32	54	36	2	Y-5N4Q2U323654B	1,105
32	60	36	2	Y-5N4Q2U323660B	1,355
32	66	36	2	Y-5N4Q2U323666B	1,392
32	72	36	2	Y-5N4Q2U323672B	1,426
32	78	36	2	Y-5N4Q2U323678B	1,463
32	84	36	2	Y-5N4Q2U323684B	1,498

PET NOMINAL = ACTUAL SIZE U-WRAP UNDER SURFACE MOUNT LITE SCREENS

H	W	D	PET Pieces	Model Number	List
12	42	42	2	Y-5N4Q2U124242B	704
12	48	42	2	Y-5N4Q2U124248B	713
12	54	42	2	Y-5N4Q2U124254B	791
12	60	42	2	Y-5N4Q2U124260B	800
12	66	42	2	Y-5N4Q2U124266B	808
12	72	42	2	Y-5N4Q2U124272B	820
12	78	42	2	Y-5N4Q2U124278B	829
12	84	42	2	Y-5N4Q2U124284B	837
16	42	42	2	Y-5N4Q2U164242B	748
16	48	42	2	Y-5N4Q2U164248B	761
16	54	42	2	Y-5N4Q2U164254B	864
16	60	42	2	Y-5N4Q2U164260B	876
16	66	42	2	Y-5N4Q2U164266B	889
16	72	42	2	Y-5N4Q2U164272B	901
16	78	42	2	Y-5N4Q2U164278B	914
16	84	42	2	Y-5N4Q2U164284B	927

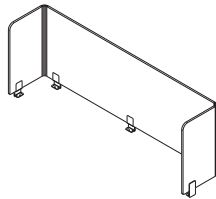

1 PET Piece

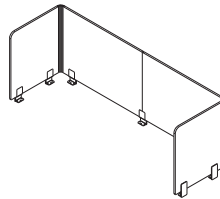

2 PET Pieces

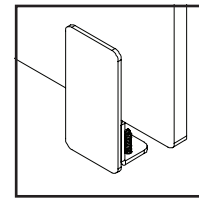

Under Surface Mount Lite

Specify

- Paint Selection for Lite Clip
- Color Selection for PET - Lite Grey, Medium Grey, Tan or Vibrant Blue

Notes

- PET U-Wrap Screens are designed to mount to AIS worksurfaces. Specify based on nominal size for the desired system. Order screens that correspond to worksurface width and depth.
- PET screen inserts are 1/2" (12mm) thick.
- U-Wrap screens typically constructed with 2 pieces of PET, some smaller sizes are constructed from 1 piece when possible. See PET Pieces column for specific details.

PET Nominal = Actual Size U-Wrap Under Surface Mount Lite Screens

Material	Where Used	Screen Type	Sized For	Mount Type
PET	U-Wrap on Worksurface	Lite	U-Wrap for Nominal = Actual Size	Under Surface Mount

**PET NOMINAL = ACTUAL SIZE
U-WRAP UNDER SURFACE MOUNT LITE SCREENS**

H	W	D	PET Pieces	Model Number	List
20	42	42	2	Y-5N4Q2U204242B	794
20	48	42	2	Y-5N4Q2U204248B	808
20	54	42	2	Y-5N4Q2U204254B	937
20	60	42	2	Y-5N4Q2U204260B	954
20	66	42	2	Y-5N4Q2U204266B	969
20	72	42	2	Y-5N4Q2U204272B	985
20	78	42	2	Y-5N4Q2U204278B	999
20	84	42	2	Y-5N4Q2U204284B	1,018
24	42	42	2	Y-5N4Q2U244242B	837
24	48	42	2	Y-5N4Q2U244248B	858
24	54	42	2	Y-5N4Q2U244254B	1,010
24	60	42	2	Y-5N4Q2U244260B	1,029
24	66	42	2	Y-5N4Q2U244266B	1,049
24	72	42	2	Y-5N4Q2U244272B	1,068
24	78	42	2	Y-5N4Q2U244278B	1,088
24	84	42	2	Y-5N4Q2U244284B	1,105

**PET NOMINAL = ACTUAL SIZE
U-WRAP UNDER SURFACE MOUNT LITE SCREENS**

H	W	D	PET Pieces	Model Number	List
28	42	42	2	Y-5N4Q2U284242B	881
28	48	42	2	Y-5N4Q2U284248B	904
28	54	42	2	Y-5N4Q2U284254B	1,085
28	60	42	2	Y-5N4Q2U284260B	1,105
28	66	42	2	Y-5N4Q2U284266B	1,128
28	72	42	2	Y-5N4Q2U284272B	1,151
28	78	42	2	Y-5N4Q2U284278B	1,172
28	84	42	2	Y-5N4Q2U284284B	1,196
32	42	42	2	Y-5N4Q2U324242B	1,069
32	48	42	2	Y-5N4Q2U324248B	1,105
32	54	42	2	Y-5N4Q2U324254B	1,392
32	60	42	2	Y-5N4Q2U324260B	1,426
32	66	42	2	Y-5N4Q2U324266B	1,463
32	72	42	2	Y-5N4Q2U324272B	1,498
32	78	42	2	Y-5N4Q2U324278B	1,535
32	84	42	2	Y-5N4Q2U324284B	1,571

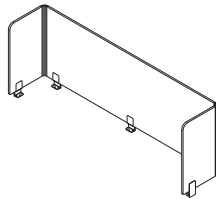

1 PET Piece

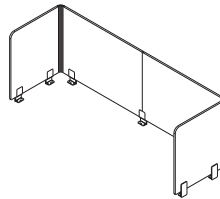

2 PET Pieces

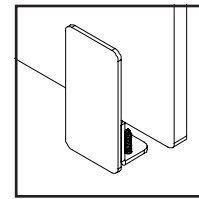

Under Surface Mount Lite

Specify

- Paint Selection for Lite Clip
- Color Selection for PET - Lite Grey, Medium Grey, Tan or Vibrant Blue

Notes

- PET U-Wrap Screens are designed to mount to AIS worksurfaces. Specify based on nominal size for the desired system. Order screens that correspond to worksurface width and depth.
- PET screen inserts are 1/2" (12mm) thick.
- U-Wrap screens typically constructed with 2 pieces of PET, some smaller sizes are constructed from 1 piece when possible. See PET Pieces column for specific details.

PET Nominal = Actual Size U-Wrap Partial Modesty Under Surface Mount Lite Screens

Material	Where Used	Screen Type	Sized For	Mount Type
PET	U-Wrap Partial Modesty on WS	Lite	U-Wrap for Nominal = Actual Size	Under Surface Mount

PET NOMINAL = ACTUAL SIZE U-WRAP PARTIAL MODESTY UNDER SURFACE MOUNT LITE SCREENS

H	W	D	PET Pieces	Model Number	List
38	42	12	1 PC	Y-5Q4Q2U381242B	951
38	48	12	1 PC	Y-5Q4Q2U381248B	994
38	54	12	1 PC	Y-5Q4Q2U381254B	1,036
38	60	12	1 PC	Y-5Q4Q2U381260B	1,077
38	66	12	1 PC	Y-5Q4Q2U381266B	1,122
38	72	12	2 PC	Y-5Q4Q2U381272B	1,163
38	78	12	2 PC	Y-5Q4Q2U381278B	1,206
38	84	12	2 PC	Y-5Q4Q2U381284B	1,332
42	42	12	1 PC	Y-5Q4Q2U421242B	991
42	48	12	1 PC	Y-5Q4Q2U421248B	1,037
42	54	12	1 PC	Y-5Q4Q2U421254B	1,086
42	60	12	1 PC	Y-5Q4Q2U421260B	1,131
42	66	12	1 PC	Y-5Q4Q2U421266B	1,179
42	72	12	2 PC	Y-5Q4Q2U421272B	1,224
42	78	12	2 PC	Y-5Q4Q2U421278B	1,274
42	84	12	2 PC	Y-5Q4Q2U421284B	1,414

PET NOMINAL = ACTUAL SIZE U-WRAP PARTIAL MODESTY UNDER SURFACE MOUNT LITE SCREENS

H	W	D	PET Pieces	Model Number	List
22	42	18	1 PC	Y-5Q4Q2U221842B	746
22	48	18	1 PC	Y-5Q4Q2U221848B	763
22	54	18	1 PC	Y-5Q4Q2U221854B	779
22	60	18	2 PC	Y-5Q4Q2U221860B	798
22	66	18	2 PC	Y-5Q4Q2U221866B	815
22	72	18	2 PC	Y-5Q4Q2U221872B	833
22	78	18	2 PC	Y-5Q4Q2U221878B	904
22	84	18	2 PC	Y-5Q4Q2U221884B	921
26	42	18	1 PC	Y-5Q4Q2U261842B	776
26	48	18	1 PC	Y-5Q4Q2U261848B	798
26	54	18	1 PC	Y-5Q4Q2U261854B	818
26	60	18	2 PC	Y-5Q4Q2U261860B	839
26	66	18	2 PC	Y-5Q4Q2U261866B	860
26	72	18	2 PC	Y-5Q4Q2U261872B	880
26	78	18	2 PC	Y-5Q4Q2U261878B	964
26	84	18	2 PC	Y-5Q4Q2U261884B	985

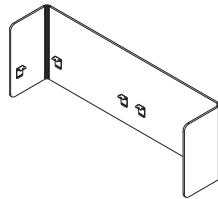

1 PET Piece

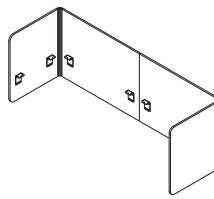

2 PET Pieces

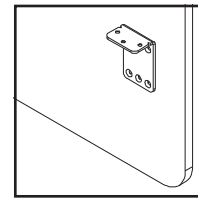

Partial Modesty L-Brackets

Specify

- Paint Selection for Lite Clip
- Color Selection for PET - Lite Grey, Medium Grey, Tan or Vibrant Blue

Notes

- PET U-Wrap Screens are designed to mount to AIS worksurfaces. Specify based on nominal size for the desired system. Order screens that correspond to worksurface width and depth.
- PET screen inserts are 1/2" (12mm) thick.
- U-Wrap screens typically constructed with 2 pieces of PET, some smaller sizes are constructed from 1 piece when possible. See PET Pieces column for specific details.

PET Nominal = Actual Size U-Wrap Partial Modesty Under Surface Mount Lite Screens

Material	Where Used	Screen Type	Sized For	Mount Type
PET	U-Wrap Partial Modesty on WS	Lite	U-Wrap for Nominal = Actual Size	Under Surface Mount

PET NOMINAL = ACTUAL SIZE U-WRAP PARTIAL MODESTY UNDER SURFACE MOUNT LITE SCREENS

H	W	D	PET Pieces	Model Number	List
30	42	18	1 PC	Y-5Q4Q2U301842B	1,006
30	48	18	1 PC	Y-5Q4Q2U301848B	1,038
30	54	18	1 PC	Y-5Q4Q2U301854B	1,072
30	60	18	2 PC	Y-5Q4Q2U301860B	1,105
30	66	18	2 PC	Y-5Q4Q2U301866B	1,139
30	72	18	2 PC	Y-5Q4Q2U301872B	1,172
30	78	18	2 PC	Y-5Q4Q2U301878B	1,207
30	84	18	2 PC	Y-5Q4Q2U301884B	1,239
34	42	18	1 PC	Y-5Q4Q2U341842B	950
34	48	18	1 PC	Y-5Q4Q2U341848B	988
34	54	18	1 PC	Y-5Q4Q2U341854B	1,025
34	60	18	2 PC	Y-5Q4Q2U341860B	1,062
34	66	18	2 PC	Y-5Q4Q2U341866B	1,100
34	72	18	2 PC	Y-5Q4Q2U341872B	1,139
34	78	18	2 PC	Y-5Q4Q2U341878B	1,291
34	84	18	2 PC	Y-5Q4Q2U341884B	1,329

PET NOMINAL = ACTUAL SIZE U-WRAP PARTIAL MODESTY UNDER SURFACE MOUNT LITE SCREENS

H	W	D	PET Pieces	Model Number	List
38	42	18	1 PC	Y-5Q4Q2U381842B	994
38	48	18	1 PC	Y-5Q4Q2U381848B	1,036
38	54	18	1 PC	Y-5Q4Q2U381854B	1,077
38	60	18	2 PC	Y-5Q4Q2U381860B	1,122
38	66	18	2 PC	Y-5Q4Q2U381866B	1,163
38	72	18	2 PC	Y-5Q4Q2U381872B	1,206
38	78	18	2 PC	Y-5Q4Q2U381878B	1,375
38	84	18	2 PC	Y-5Q4Q2U381884B	1,420
42	42	18	1 PC	Y-5Q4Q2U421842B	1,037
42	48	18	1 PC	Y-5Q4Q2U421848B	1,086
42	54	18	1 PC	Y-5Q4Q2U421854B	1,131
42	60	18	2 PC	Y-5Q4Q2U421860B	1,179
42	66	18	2 PC	Y-5Q4Q2U421866B	1,224
42	72	18	2 PC	Y-5Q4Q2U421872B	1,274
42	78	18	2 PC	Y-5Q4Q2U421878B	1,461
42	84	18	2 PC	Y-5Q4Q2U421884B	1,508

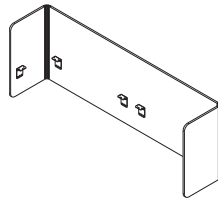

1 PET Piece

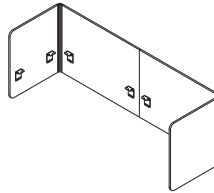

2 PET Pieces

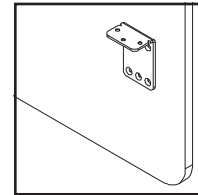

Partial Modesty L-Brackets

Specify

- Paint Selection for Lite Clip
- Color Selection for PET - Lite Grey, Medium Grey, Tan or Vibrant Blue

Notes

- PET U-Wrap Screens are designed to mount to AIS worksurfaces. Specify based on nominal size for the desired system. Order screens that correspond to worksurface width and depth.
- PET screen inserts are 1/2" (12mm) thick.
- U-Wrap screens typically constructed with 2 pieces of PET, some smaller sizes are constructed from 1 piece when possible. See PET Pieces column for specific details.

PET Nominal = Actual Size U-Wrap Partial Modesty Under Surface Mount Lite Screens

Material	Where Used	Screen Type	Sized For	Mount Type
PET	U-Wrap Partial Modesty on WS	Lite	U-Wrap for Nominal = Actual Size	Under Surface Mount

PET NOMINAL = ACTUAL SIZE U-WRAP PARTIAL MODESTY UNDER SURFACE MOUNT LITE SCREENS

H	W	D	PET Pieces	Model Number	List
22	42	24	1 PC	Y-5Q4Q2U222442B	763
22	48	24	2 PC	Y-5Q4Q2U222448B	779
22	54	24	2 PC	Y-5Q4Q2U222454B	798
22	60	24	2 PC	Y-5Q4Q2U222460B	815
22	66	24	2 PC	Y-5Q4Q2U222466B	833
22	72	24	2 PC	Y-5Q4Q2U222472B	921
22	78	24	2 PC	Y-5Q4Q2U222478B	939
22	84	24	2 PC	Y-5Q4Q2U222484B	956
26	42	24	1 PC	Y-5Q4Q2U262442B	798
26	48	24	2 PC	Y-5Q4Q2U262448B	818
26	54	24	2 PC	Y-5Q4Q2U262454B	839
26	60	24	2 PC	Y-5Q4Q2U262460B	860
26	66	24	2 PC	Y-5Q4Q2U262466B	880
26	72	24	2 PC	Y-5Q4Q2U262472B	985
26	78	24	2 PC	Y-5Q4Q2U262478B	1,006
26	84	24	2 PC	Y-5Q4Q2U262484B	1,026

PET NOMINAL = ACTUAL SIZE U-WRAP PARTIAL MODESTY UNDER SURFACE MOUNT LITE SCREENS

H	W	D	PET Pieces	Model Number	List
30	42	24	1 PC	Y-5Q4Q2U302442B	1,072
30	48	24	2 PC	Y-5Q4Q2U302448B	1,105
30	54	24	2 PC	Y-5Q4Q2U302454B	1,139
30	60	24	2 PC	Y-5Q4Q2U302460B	1,172
30	66	24	2 PC	Y-5Q4Q2U302466B	1,207
30	72	24	2 PC	Y-5Q4Q2U302472B	1,239
30	78	24	2 PC	Y-5Q4Q2U302478B	1,274
30	84	24	2 PC	Y-5Q4Q2U302484B	1,308
34	42	24	1 PC	Y-5Q4Q2U342442B	988
34	48	24	2 PC	Y-5Q4Q2U342448B	1,025
34	54	24	2 PC	Y-5Q4Q2U342454B	1,062
34	60	24	2 PC	Y-5Q4Q2U342460B	1,100
34	66	24	2 PC	Y-5Q4Q2U342466B	1,139
34	72	24	2 PC	Y-5Q4Q2U342472B	1,329
34	78	24	2 PC	Y-5Q4Q2U342478B	1,366
34	84	24	2 PC	Y-5Q4Q2U342484B	1,404

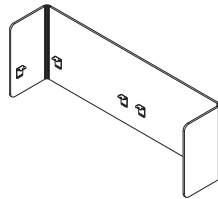

1 PET Piece

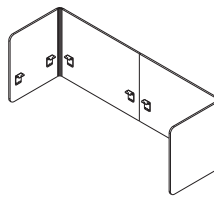

2 PET Pieces

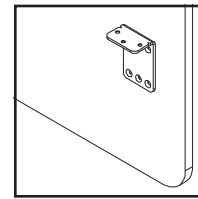

Partial Modesty L-Brackets

Specify

- Paint Selection for Lite Clip
- Color Selection for PET - Lite Grey, Medium Grey, Tan or Vibrant Blue

Notes

- PET U-Wrap Screens are designed to mount to AIS worksurfaces. Specify based on nominal size for the desired system. Order screens that correspond to worksurface width and depth.
- PET screen inserts are 1/2" (12mm) thick.
- U-Wrap screens typically constructed with 2 pieces of PET, some smaller sizes are constructed from 1 piece when possible. See PET Pieces column for specific details.

PET Nominal = Actual Size U-Wrap Partial Modesty Under Surface Mount Lite Screens

Material	Where Used	Screen Type	Sized For	Mount Type
PET	U-Wrap Partial Modesty on WS	Lite	U-Wrap for Nominal = Actual Size	Under Surface Mount

PET NOMINAL = ACTUAL SIZE U-WRAP PARTIAL MODESTY UNDER SURFACE MOUNT LITE SCREENS

H	W	D	PET Pieces	Model Number	List
38	42	24	1 PC	Y-5Q4Q2U382442B	1,036
38	48	24	2 PC	Y-5Q4Q2U382448B	1,077
38	54	24	2 PC	Y-5Q4Q2U382454B	1,122
38	60	24	2 PC	Y-5Q4Q2U382460B	1,163
38	66	24	2 PC	Y-5Q4Q2U382466B	1,206
38	72	24	2 PC	Y-5Q4Q2U382472B	1,420
38	78	24	2 PC	Y-5Q4Q2U382478B	1,461
38	84	24	2 PC	Y-5Q4Q2U382484B	1,504
42	42	24	1 PC	Y-5Q4Q2U422442B	1,086
42	48	24	2 PC	Y-5Q4Q2U422448B	1,131
42	54	24	2 PC	Y-5Q4Q2U422454B	1,179
42	60	24	2 PC	Y-5Q4Q2U422460B	1,224
42	66	24	2 PC	Y-5Q4Q2U422466B	1,274
42	72	24	2 PC	Y-5Q4Q2U422472B	1,508
42	78	24	2 PC	Y-5Q4Q2U422478B	1,554
42	84	24	2 PC	Y-5Q4Q2U422484B	1,602

PET NOMINAL = ACTUAL SIZE U-WRAP PARTIAL MODESTY UNDER SURFACE MOUNT LITE SCREENS

H	W	D	PET Pieces	Model Number	List
22	42	30	2 PC	Y-5Q4Q2U223042B	779
22	48	30	2 PC	Y-5Q4Q2U223048B	798
22	54	30	2 PC	Y-5Q4Q2U223054B	815
22	60	30	2 PC	Y-5Q4Q2U223060B	833
22	66	30	2 PC	Y-5Q4Q2U223066B	939
22	72	30	2 PC	Y-5Q4Q2U223072B	956
22	78	30	2 PC	Y-5Q4Q2U223078B	975
22	84	30	2 PC	Y-5Q4Q2U223084B	991
26	42	30	2 PC	Y-5Q4Q2U263042B	818
26	48	30	2 PC	Y-5Q4Q2U263048B	839
26	54	30	2 PC	Y-5Q4Q2U263054B	860
26	60	30	2 PC	Y-5Q4Q2U263060B	880
26	66	30	2 PC	Y-5Q4Q2U263066B	1,006
26	72	30	2 PC	Y-5Q4Q2U263072B	1,026
26	78	30	2 PC	Y-5Q4Q2U263078B	1,048
26	84	30	2 PC	Y-5Q4Q2U263084B	1,068

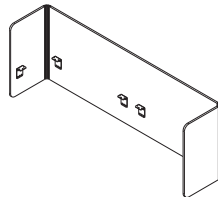

1 PET Piece

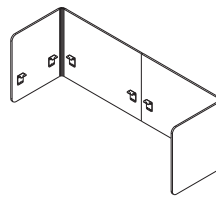

2 PET Pieces

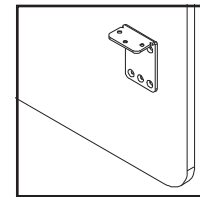

Partial Modesty L-Brackets

Specify

- Paint Selection for Lite Clip
- Color Selection for PET - Lite Grey, Medium Grey, Tan or Vibrant Blue

Notes

- PET U-Wrap Screens are designed to mount to AIS worksurfaces. Specify based on nominal size for the desired system. Order screens that correspond to worksurface width and depth.
- PET screen inserts are 1/2" (12mm) thick.
- U-Wrap screens typically constructed with 2 pieces of PET, some smaller sizes are constructed from 1 piece when possible. See PET Pieces column for specific details.

PET Nominal = Actual Size U-Wrap Partial Modesty Under Surface Mount Lite Screens

Material	Where Used	Screen Type	Sized For	Mount Type
PET	U-Wrap Partial Modesty on WS	Lite	U-Wrap for Nominal = Actual Size	Under Surface Mount

PET NOMINAL = ACTUAL SIZE U-WRAP PARTIAL MODESTY UNDER SURFACE MOUNT LITE SCREENS

H	W	D	PET Pieces	Model Number	List
30	42	30	2 PC	Y-5Q4Q2U303042B	1,139
30	48	30	2 PC	Y-5Q4Q2U303048B	1,172
30	54	30	2 PC	Y-5Q4Q2U303054B	1,207
30	60	30	2 PC	Y-5Q4Q2U303060B	1,239
30	66	30	2 PC	Y-5Q4Q2U303066B	1,274
30	72	30	2 PC	Y-5Q4Q2U303072B	1,308
30	78	30	2 PC	Y-5Q4Q2U303078B	1,341
30	84	30	2 PC	Y-5Q4Q2U303084B	1,373
34	42	30	2 PC	Y-5Q4Q2U343042B	1,025
34	48	30	2 PC	Y-5Q4Q2U343048B	1,062
34	54	30	2 PC	Y-5Q4Q2U343054B	1,100
34	60	30	2 PC	Y-5Q4Q2U343060B	1,139
34	66	30	2 PC	Y-5Q4Q2U343066B	1,366
34	72	30	2 PC	Y-5Q4Q2U343072B	1,404
34	78	30	2 PC	Y-5Q4Q2U343078B	1,442
34	84	30	2 PC	Y-5Q4Q2U343084B	1,481

PET NOMINAL = ACTUAL SIZE U-WRAP PARTIAL MODESTY UNDER SURFACE MOUNT LITE SCREENS

H	W	D	PET Pieces	Model Number	List
38	42	30	2 PC	Y-5Q4Q2U383042B	1,077
38	48	30	2 PC	Y-5Q4Q2U383048B	1,122
38	54	30	2 PC	Y-5Q4Q2U383054B	1,163
38	60	30	2 PC	Y-5Q4Q2U383060B	1,206
38	66	30	2 PC	Y-5Q4Q2U383066B	1,461
38	72	30	2 PC	Y-5Q4Q2U383072B	1,504
38	78	30	2 PC	Y-5Q4Q2U383078B	1,545
38	84	30	2 PC	Y-5Q4Q2U383084B	1,587
42	42	30	2 PC	Y-5Q4Q2U423042B	1,131
42	48	30	2 PC	Y-5Q4Q2U423048B	1,179
42	54	30	2 PC	Y-5Q4Q2U423054B	1,224
42	60	30	2 PC	Y-5Q4Q2U423060B	1,274
42	66	30	2 PC	Y-5Q4Q2U423066B	1,554
42	72	30	2 PC	Y-5Q4Q2U423072B	1,602
42	78	30	2 PC	Y-5Q4Q2U423078B	1,647
42	84	30	2 PC	Y-5Q4Q2U423084B	1,694

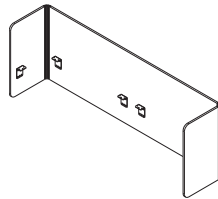

1 PET Piece

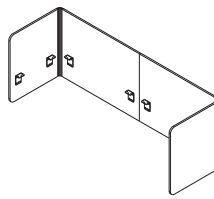

2 PET Pieces

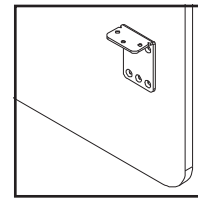

Partial Modesty L-Brackets

Specify

- Paint Selection for Lite Clip
- Color Selection for PET - Lite Grey, Medium Grey, Tan or Vibrant Blue

Notes

- PET U-Wrap Screens are designed to mount to AIS worksurfaces. Specify based on nominal size for the desired system. Order screens that correspond to worksurface width and depth.
- PET screen inserts are 1/2" (12mm) thick.
- U-Wrap screens typically constructed with 2 pieces of PET, some smaller sizes are constructed from 1 piece when possible. See PET Pieces column for specific details.

PET Nominal = Actual Size U-Wrap Partial Modesty Under Surface Mount Lite Screens

Material	Where Used	Screen Type	Sized For	Mount Type
PET	U-Wrap Partial Modesty on WS	Lite	U-Wrap for Nominal = Actual Size	Under Surface Mount

PET NOMINAL = ACTUAL SIZE U-WRAP PARTIAL MODESTY UNDER SURFACE MOUNT LITE SCREENS

H	W	D	PET Pieces	Model Number	List
22	42	36	2 PC	Y-5Q4Q2U223642B	798
22	48	36	2 PC	Y-5Q4Q2U223648B	815
22	54	36	2 PC	Y-5Q4Q2U223654B	833
22	60	36	2 PC	Y-5Q4Q2U223660B	956
22	66	36	2 PC	Y-5Q4Q2U223666B	975
22	72	36	2 PC	Y-5Q4Q2U223672B	991
22	78	36	2 PC	Y-5Q4Q2U223678B	1,009
22	84	36	2 PC	Y-5Q4Q2U223684B	1,026
26	42	36	2 PC	Y-5Q4Q2U263642B	839
26	48	36	2 PC	Y-5Q4Q2U263648B	860
26	54	36	2 PC	Y-5Q4Q2U263654B	880
26	60	36	2 PC	Y-5Q4Q2U263660B	1,026
26	66	36	2 PC	Y-5Q4Q2U263666B	1,048
26	72	36	2 PC	Y-5Q4Q2U263672B	1,068
26	78	36	2 PC	Y-5Q4Q2U263678B	1,089
26	84	36	2 PC	Y-5Q4Q2U263684B	1,109

PET NOMINAL = ACTUAL SIZE U-WRAP PARTIAL MODESTY UNDER SURFACE MOUNT LITE SCREENS

H	W	D	PET Pieces	Model Number	List
30	42	36	2 PC	Y-5Q4Q2U303642B	1,207
30	48	36	2 PC	Y-5Q4Q2U303648B	1,239
30	54	36	2 PC	Y-5Q4Q2U303654B	1,274
30	60	36	2 PC	Y-5Q4Q2U303660B	1,308
30	66	36	2 PC	Y-5Q4Q2U303666B	1,341
30	72	36	2 PC	Y-5Q4Q2U303672B	1,373
30	78	36	2 PC	Y-5Q4Q2U303678B	1,408
30	84	36	2 PC	Y-5Q4Q2U303684B	1,441
34	42	36	2 PC	Y-5Q4Q2U343642B	1,062
34	48	36	2 PC	Y-5Q4Q2U343648B	1,100
34	54	36	2 PC	Y-5Q4Q2U343654B	1,139
34	60	36	2 PC	Y-5Q4Q2U343660B	1,404
34	66	36	2 PC	Y-5Q4Q2U343666B	1,442
34	72	36	2 PC	Y-5Q4Q2U343672B	1,481
34	78	36	2 PC	Y-5Q4Q2U343678B	1,519
34	84	36	2 PC	Y-5Q4Q2U343684B	1,556

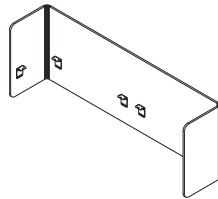

1 PET Piece

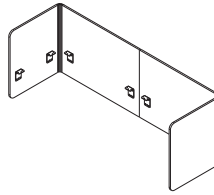

2 PET Pieces

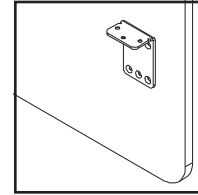

Partial Modesty L-Brackets

Specify

- Paint Selection for Lite Clip
- Color Selection for PET - Lite Grey, Medium Grey, Tan or Vibrant Blue

Notes

- PET U-Wrap Screens are designed to mount to AIS worksurfaces. Specify based on nominal size for the desired system. Order screens that correspond to worksurface width and depth.
- PET screen inserts are 1/2" (12mm) thick.
- U-Wrap screens typically constructed with 2 pieces of PET, some smaller sizes are constructed from 1 piece when possible. See PET Pieces column for specific details.

PET Nominal = Actual Size U-Wrap Partial Modesty Under Surface Mount Lite Screens

Material	Where Used	Screen Type	Sized For	Mount Type
PET	U-Wrap Partial Modesty on WS	Lite	U-Wrap for Nominal = Actual Size	Under Surface Mount

PET NOMINAL = ACTUAL SIZE U-WRAP PARTIAL MODESTY UNDER SURFACE MOUNT LITE SCREENS

H	W	D	PET Pieces	Model Number	List
38	42	36	2 PC	Y-5Q4Q2U383642B	1,122
38	48	36	2 PC	Y-5Q4Q2U383648B	1,163
38	54	36	2 PC	Y-5Q4Q2U383654B	1,206
38	60	36	2 PC	Y-5Q4Q2U383660B	1,504
38	66	36	2 PC	Y-5Q4Q2U383666B	1,545
38	72	36	2 PC	Y-5Q4Q2U383672B	1,587
38	78	36	2 PC	Y-5Q4Q2U383678B	1,630
38	84	36	2 PC	Y-5Q4Q2U383684B	1,672
42	42	36	2 PC	Y-5Q4Q2U423642B	1,179
42	48	36	2 PC	Y-5Q4Q2U423648B	1,224
42	54	36	2 PC	Y-5Q4Q2U423654B	1,274
42	60	36	2 PC	Y-5Q4Q2U423660B	1,602
42	66	36	2 PC	Y-5Q4Q2U423666B	1,647
42	72	36	2 PC	Y-5Q4Q2U423672B	1,694
42	78	36	2 PC	Y-5Q4Q2U423678B	1,741
42	84	36	2 PC	Y-5Q4Q2U423684B	1,788

PET NOMINAL = ACTUAL SIZE U-WRAP PARTIAL MODESTY UNDER SURFACE MOUNT LITE SCREENS

H	W	D	PET Pieces	Model Number	List
22	42	42	2 PC	Y-5Q4Q2U224242B	815
22	48	42	2 PC	Y-5Q4Q2U224248B	833
22	54	42	2 PC	Y-5Q4Q2U224254B	975
22	60	42	2 PC	Y-5Q4Q2U224260B	991
22	66	42	2 PC	Y-5Q4Q2U224266B	1,009
22	72	42	2 PC	Y-5Q4Q2U224272B	1,026
22	78	42	2 PC	Y-5Q4Q2U224278B	1,045
22	84	42	2 PC	Y-5Q4Q2U224284B	1,061
26	42	42	2 PC	Y-5Q4Q2U264242B	860
26	48	42	2 PC	Y-5Q4Q2U264248B	880
26	54	42	2 PC	Y-5Q4Q2U264254B	1,048
26	60	42	2 PC	Y-5Q4Q2U264260B	1,068
26	66	42	2 PC	Y-5Q4Q2U264266B	1,089
26	72	42	2 PC	Y-5Q4Q2U264272B	1,109
26	78	42	2 PC	Y-5Q4Q2U264278B	1,130
26	84	42	2 PC	Y-5Q4Q2U264284B	1,151

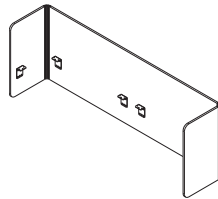

1 PET Piece

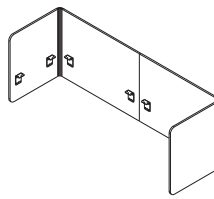

2 PET Pieces

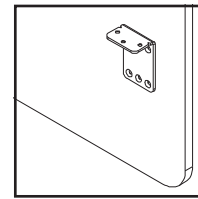

Partial Modesty L-Brackets

Specify

- Paint Selection for Lite Clip
- Color Selection for PET - Lite Grey, Medium Grey, Tan or Vibrant Blue

Notes

- PET U-Wrap Screens are designed to mount to AIS worksurfaces. Specify based on nominal size for the desired system. Order screens that correspond to worksurface width and depth.
- PET screen inserts are 1/2" (12mm) thick.
- U-Wrap screens typically constructed with 2 pieces of PET, some smaller sizes are constructed from 1 piece when possible. See PET Pieces column for specific details.

PET Nominal = Actual Size U-Wrap Partial Modesty Under Surface Mount Lite Screens

Material	Where Used	Screen Type	Sized For	Mount Type
PET	U-Wrap Partial Modesty on WS	Lite	U-Wrap for Nominal = Actual Size	Under Surface Mount

PET NOMINAL = ACTUAL SIZE U-WRAP PARTIAL MODESTY UNDER SURFACE MOUNT LITE SCREENS

H	W	D	PET Pieces	Model Number	List
30	42	42	2 PC	Y-5Q4Q2U304242B	1,274
30	48	42	2 PC	Y-5Q4Q2U304248B	1,308
30	54	42	2 PC	Y-5Q4Q2U304254B	1,341
30	60	42	2 PC	Y-5Q4Q2U304260B	1,373
30	66	42	2 PC	Y-5Q4Q2U304266B	1,408
30	72	42	2 PC	Y-5Q4Q2U304272B	1,441
30	78	42	2 PC	Y-5Q4Q2U304278B	1,474
30	84	42	2 PC	Y-5Q4Q2U304284B	1,508
34	42	42	2 PC	Y-5Q4Q2U344242B	1,100
34	48	42	2 PC	Y-5Q4Q2U344248B	1,139
34	54	42	2 PC	Y-5Q4Q2U344254B	1,442
34	60	42	2 PC	Y-5Q4Q2U344260B	1,481
34	66	42	2 PC	Y-5Q4Q2U344266B	1,519
34	72	42	2 PC	Y-5Q4Q2U344272B	1,556
34	78	42	2 PC	Y-5Q4Q2U344278B	1,593
34	84	42	2 PC	Y-5Q4Q2U344284B	1,631

PET NOMINAL = ACTUAL SIZE U-WRAP PARTIAL MODESTY UNDER SURFACE MOUNT LITE SCREENS

H	W	D	PET Pieces	Model Number	List
38	42	42	2 PC	Y-5Q4Q2U384242B	1,163
38	48	42	2 PC	Y-5Q4Q2U384248B	1,206
38	54	42	2 PC	Y-5Q4Q2U384254B	1,545
38	60	42	2 PC	Y-5Q4Q2U384260B	1,587
38	66	42	2 PC	Y-5Q4Q2U384266B	1,630
38	72	42	2 PC	Y-5Q4Q2U384272B	1,672
38	78	42	2 PC	Y-5Q4Q2U384278B	1,716
38	84	42	2 PC	Y-5Q4Q2U384284B	1,757
42	42	42	2 PC	Y-5Q4Q2U424242B	1,224
42	48	42	2 PC	Y-5Q4Q2U424248B	1,274
42	54	42	2 PC	Y-5Q4Q2U424254B	1,647
42	60	42	2 PC	Y-5Q4Q2U424260B	1,694
42	66	42	2 PC	Y-5Q4Q2U424266B	1,741
42	72	42	2 PC	Y-5Q4Q2U424272B	1,788
42	78	42	2 PC	Y-5Q4Q2U424278B	1,835
42	84	42	2 PC	Y-5Q4Q2U424284B	1,882

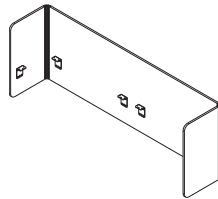

1 PET Piece

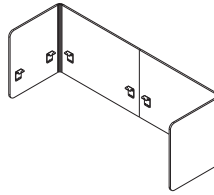

2 PET Pieces

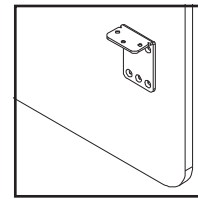

Partial Modesty L-Brackets

Specify

- Paint Selection for Lite Clip
- Color Selection for PET - Lite Grey, Medium Grey, Tan or Vibrant Blue

Notes

- PET U-Wrap Screens are designed to mount to AIS worksurfaces. Specify based on nominal size for the desired system. Order screens that correspond to worksurface width and depth.
- PET screen inserts are 1/2" (12mm) thick.
- U-Wrap screens typically constructed with 2 pieces of PET, some smaller sizes are constructed from 1 piece when possible. See PET Pieces column for specific details.

PET L-Wrap Enclosures with Wire Managers

PET Nominal = Actual Size L-Wrap Enclosures with Wire Managers

Material	Where Used	Screen Type	Sized For	Mount Type	Handedness
PET	L-Wrap Partial Modesty on WS	Enclosure	L-Wrap for Nominal = Actual Size	Under Surface Mount	Left or Right

PET NOMINAL = ACTUAL SIZE L-WRAP ENCLOSURES WITH WIRE MANAGERS

H	W	D	Left Hand	Right Hand	List
			Model Number	Model Number	
3	24	12	Y-5M8M2L031224B	Y-5M8M2R031224B	714
3	30	12	Y-5M8M2L031230B	Y-5M8M2R031230B	733
3	36	12	Y-5M8M2L031236B	Y-5M8M2R031236B	750
3	42	12	Y-5M8M2L031242B	Y-5M8M2R031242B	768
3	48	12	Y-5M8M2L031248B	Y-5M8M2R031248B	788
3	54	12	Y-5M8M2L031254B	Y-5M8M2R031254B	806
3	60	12	Y-5M8M2L031260B	Y-5M8M2R031260B	825
3	66	12	Y-5M8M2L031266B	Y-5M8M2R031266B	843
3	72	12	Y-5M8M2L031272B	Y-5M8M2R031272B	860
3	78	12	Y-5M8M2L031278B	Y-5M8M2R031278B	880
3	24	18	Y-5M8M2L031824B	Y-5M8M2R031824B	733
3	30	18	Y-5M8M2L031830B	Y-5M8M2R031830B	750
3	36	18	Y-5M8M2L031836B	Y-5M8M2R031836B	768
3	42	18	Y-5M8M2L031842B	Y-5M8M2R031842B	788
3	48	18	Y-5M8M2L031848B	Y-5M8M2R031848B	806
3	54	18	Y-5M8M2L031854B	Y-5M8M2R031854B	825
3	60	18	Y-5M8M2L031860B	Y-5M8M2R031860B	843
3	66	18	Y-5M8M2L031866B	Y-5M8M2R031866B	860
3	72	18	Y-5M8M2L031872B	Y-5M8M2R031872B	880

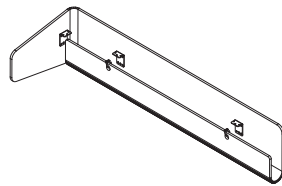

Left Hand

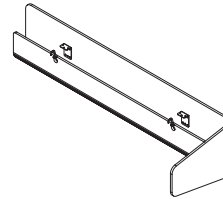

Right Hand

Specify

- Paint Selection
- Color Selection for PET - Lite Grey, Medium Grey, Tan or Vibrant Blue

Notes

- Specify based on table that enclosure is paired with.
- PET screen inserts are 1/2" (12mm) thick.
- 12" wide wings get one bracket, 18" wide and over wings get two brackets.
- 3/8" gap allows for installation of clamp-on monitors and accessories.
- Unhooks from worksurface for easy access to wire management. Access from user side.
- Height listed above is above surface height. For additional dimensions see product detail pages.

PET Nominal = Actual Size L-Wrap Enclosures with Wire Managers

Material	Where Used	Screen Type	Sized For	Mount Type	Handedness
PET	L-Wrap Partial Modesty on WS	Enclosure	L-Wrap for Nominal = Actual Size	Under Surface Mount	Left or Right

PET NOMINAL = ACTUAL SIZE L-WRAP ENCLOSURES WITH WIRE MANAGERS

H	W	D	Left Hand	Right Hand	List
			Model Number	Model Number	
3	24	24	Y-5M8M2L032424B	Y-5M8M2R032424B	750
3	30	24	Y-5M8M2L032430B	Y-5M8M2R032430B	768
3	36	24	Y-5M8M2L032436B	Y-5M8M2R032436B	788
3	42	24	Y-5M8M2L032442B	Y-5M8M2R032442B	806
3	48	24	Y-5M8M2L032448B	Y-5M8M2R032448B	825
3	54	24	Y-5M8M2L032454B	Y-5M8M2R032454B	843
3	60	24	Y-5M8M2L032460B	Y-5M8M2R032460B	860
3	66	24	Y-5M8M2L032466B	Y-5M8M2R032466B	880
3	24	30	Y-5M8M2L033024B	Y-5M8M2R033024B	768
3	30	30	Y-5M8M2L033030B	Y-5M8M2R033030B	788
3	36	30	Y-5M8M2L033036B	Y-5M8M2R033036B	806
3	42	30	Y-5M8M2L033042B	Y-5M8M2R033042B	825
3	48	30	Y-5M8M2L033048B	Y-5M8M2R033048B	843
3	54	30	Y-5M8M2L033054B	Y-5M8M2R033054B	860
3	60	30	Y-5M8M2L033060B	Y-5M8M2R033060B	880

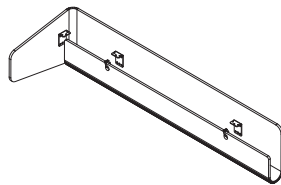

Left Hand

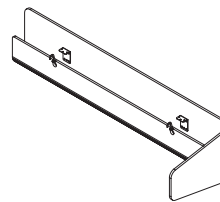

Right Hand

Specify

- Paint Selection
- Color Selection for PET - Lite Grey, Medium Grey, Tan or Vibrant Blue

Notes

- Specify based on table that enclosure is paired with.
- PET screen inserts are 1/2" (12mm) thick.
- 12" wide wings get one bracket, 18" wide and over wings get two brackets.
- 3/8" gap allows for installation of clamp-on monitors and accessories.
- Unhooks from worksurface for easy access to wire management. Access from user side.
- Height listed above is above surface height. For additional dimensions see product detail pages.

PET Nominal = Actual Size L-Wrap Enclosures with Wire Managers

Material	Where Used	Screen Type	Sized For	Mount Type	Handedness
PET	L-Wrap Partial Modesty on WS	Enclosure	L-Wrap for Nominal = Actual Size	Under Surface Mount	Left or Right

PET NOMINAL = ACTUAL SIZE L-WRAP ENCLOSURES WITH WIRE MANAGERS

H	W	D	Left Hand	Right Hand	List
			Model Number	Model Number	
12	24	12	Y-5M8M2L121224B	Y-5M8M2R121224B	744
12	30	12	Y-5M8M2L121230B	Y-5M8M2R121230B	763
12	36	12	Y-5M8M2L121236B	Y-5M8M2R121236B	782
12	42	12	Y-5M8M2L121242B	Y-5M8M2R121242B	801
12	48	12	Y-5M8M2L121248B	Y-5M8M2R121248B	820
12	54	12	Y-5M8M2L121254B	Y-5M8M2R121254B	839
12	60	12	Y-5M8M2L121260B	Y-5M8M2R121260B	858
12	66	12	Y-5M8M2L121266B	Y-5M8M2R121266B	877
12	72	12	Y-5M8M2L121272B	Y-5M8M2R121272B	897
12	78	12	Y-5M8M2L121278B	Y-5M8M2R121278B	916
12	24	18	Y-5M8M2L121824B	Y-5M8M2R121824B	763
12	30	18	Y-5M8M2L121830B	Y-5M8M2R121830B	782
12	36	18	Y-5M8M2L121836B	Y-5M8M2R121836B	801
12	42	18	Y-5M8M2L121842B	Y-5M8M2R121842B	820
12	48	18	Y-5M8M2L121848B	Y-5M8M2R121848B	839
12	54	18	Y-5M8M2L121854B	Y-5M8M2R121854B	858
12	60	18	Y-5M8M2L121860B	Y-5M8M2R121860B	877
12	66	18	Y-5M8M2L121866B	Y-5M8M2R121866B	897
12	72	18	Y-5M8M2L121872B	Y-5M8M2R121872B	916

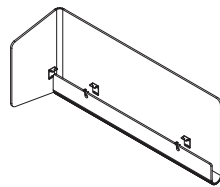

Left Hand

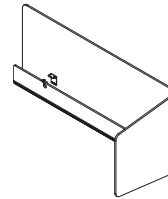

Right Hand

Specify

- Paint Selection
- Color Selection for PET - Lite Grey, Medium Grey, Tan or Vibrant Blue

Notes

- Specify based on table that enclosure is paired with.
- PET screen inserts are 1/2" (12mm) thick.
- 12" wide wings get one bracket, 18" wide and over wings get two brackets.
- 3/8" gap allows for installation of clamp-on monitors and accessories.
- Unhooks from worksurface for easy access to wire management. Access from user side.
- Height listed above is above surface height. For additional dimensions see product detail pages.

PET Nominal = Actual Size L-Wrap Enclosures with Wire Managers

Material	Where Used	Screen Type	Sized For	Mount Type	Handedness
PET	L-Wrap Partial Modesty on WS	Enclosure	L-Wrap for Nominal = Actual Size	Under Surface Mount	Left or Right

PET NOMINAL = ACTUAL SIZE L-WRAP ENCLOSURES WITH WIRE MANAGERS

H	W	D	Left Hand	Right Hand	List
			Model Number	Model Number	
12	24	24	Y-5M8M2L122424B	Y-5M8M2R122424B	782
12	30	24	Y-5M8M2L122430B	Y-5M8M2R122430B	801
12	36	24	Y-5M8M2L122436B	Y-5M8M2R122436B	820
12	42	24	Y-5M8M2L122442B	Y-5M8M2R122442B	839
12	48	24	Y-5M8M2L122448B	Y-5M8M2R122448B	858
12	54	24	Y-5M8M2L122454B	Y-5M8M2R122454B	877
12	60	24	Y-5M8M2L122460B	Y-5M8M2R122460B	897
12	66	24	Y-5M8M2L122466B	Y-5M8M2R122466B	916
12	24	30	Y-5M8M2L123024B	Y-5M8M2R123024B	801
12	30	30	Y-5M8M2L123030B	Y-5M8M2R123030B	820
12	36	30	Y-5M8M2L123036B	Y-5M8M2R123036B	839
12	42	30	Y-5M8M2L123042B	Y-5M8M2R123042B	858
12	48	30	Y-5M8M2L123048B	Y-5M8M2R123048B	877
12	54	30	Y-5M8M2L123054B	Y-5M8M2R123054B	897
12	60	30	Y-5M8M2L123060B	Y-5M8M2R123060B	916

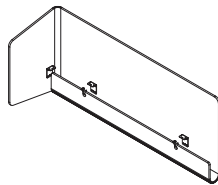

Left Hand

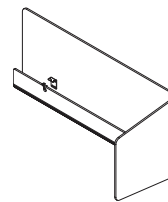

Right Hand

Specify

- Paint Selection
- Color Selection for PET - Lite Grey, Medium Grey, Tan or Vibrant Blue

Notes

- Specify based on table that enclosure is paired with.
- PET screen inserts are 1/2" (12mm) thick.
- 12" wide wings get one bracket, 18" wide and over wings get two brackets.
- 3/8" gap allows for installation of clamp-on monitors and accessories.
- Unhooks from worksurface for easy access to wire management. Access from user side.
- Height listed above is above surface height. For additional dimensions see product detail pages.

PET Nominal = Actual Size L-Wrap Enclosures with Wire Managers

Material	Where Used	Screen Type	Sized For	Mount Type	Handedness
PET	L-Wrap Partial Modesty on WS	Enclosure	L-Wrap for Nominal = Actual Size	Under Surface Mount	Left or Right

PET NOMINAL = ACTUAL SIZE L-WRAP ENCLOSURES WITH WIRE MANAGERS

H	W	D	Left Hand	Right Hand	List
			Model Number	Model Number	
16	24	12	Y-5M8M2L161224B	Y-5M8M2R161224B	765
16	30	12	Y-5M8M2L161230B	Y-5M8M2R161230B	788
16	36	12	Y-5M8M2L161236B	Y-5M8M2R161236B	809
16	42	12	Y-5M8M2L161242B	Y-5M8M2R161242B	833
16	48	12	Y-5M8M2L161248B	Y-5M8M2R161248B	855
16	54	12	Y-5M8M2L161254B	Y-5M8M2R161254B	877
16	60	12	Y-5M8M2L161260B	Y-5M8M2R161260B	900
16	66	12	Y-5M8M2L161266B	Y-5M8M2R161266B	924
16	72	12	Y-5M8M2L161272B	Y-5M8M2R161272B	948
16	78	12	Y-5M8M2L161278B	Y-5M8M2R161278B	968
16	24	18	Y-5M8M2L161824B	Y-5M8M2R161824B	788
16	30	18	Y-5M8M2L161830B	Y-5M8M2R161830B	809
16	36	18	Y-5M8M2L161836B	Y-5M8M2R161836B	833
16	42	18	Y-5M8M2L161842B	Y-5M8M2R161842B	855
16	48	18	Y-5M8M2L161848B	Y-5M8M2R161848B	877
16	54	18	Y-5M8M2L161854B	Y-5M8M2R161854B	900
16	60	18	Y-5M8M2L161860B	Y-5M8M2R161860B	924
16	66	18	Y-5M8M2L161866B	Y-5M8M2R161866B	948
16	72	18	Y-5M8M2L161872B	Y-5M8M2R161872B	968

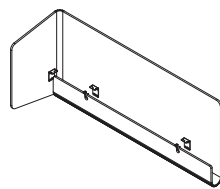

Left Hand

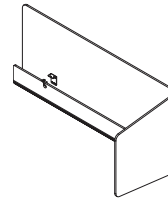

Right Hand

Specify

- Paint Selection
- Color Selection for PET - Lite Grey, Medium Grey, Tan or Vibrant Blue

Notes

- Specify based on table that enclosure is paired with.
- PET screen inserts are 1/2" (12mm) thick.
- 12" wide wings get one bracket, 18" wide and over wings get two brackets.
- 3/8" gap allows for installation of clamp-on monitors and accessories.
- Unhooks from worksurface for easy access to wire management. Access from user side.
- Height listed above is above surface height. For additional dimensions see product detail pages.

PET Nominal = Actual Size L-Wrap Enclosures with Wire Managers

Material	Where Used	Screen Type	Sized For	Mount Type	Handedness
PET	L-Wrap Partial Modesty on WS	Enclosure	L-Wrap for Nominal = Actual Size	Under Surface Mount	Left or Right

PET NOMINAL = ACTUAL SIZE L-WRAP ENCLOSURES WITH WIRE MANAGERS

H	W	D	Left Hand	Right Hand	List
			Model Number	Model Number	
16	24	24	Y-5M8M2L162424B	Y-5M8M2R162424B	809
16	30	24	Y-5M8M2L162430B	Y-5M8M2R162430B	833
16	36	24	Y-5M8M2L162436B	Y-5M8M2R162436B	855
16	42	24	Y-5M8M2L162442B	Y-5M8M2R162442B	877
16	48	24	Y-5M8M2L162448B	Y-5M8M2R162448B	900
16	54	24	Y-5M8M2L162454B	Y-5M8M2R162454B	924
16	60	24	Y-5M8M2L162460B	Y-5M8M2R162460B	948
16	66	24	Y-5M8M2L162466B	Y-5M8M2R162466B	968
16	24	30	Y-5M8M2L163024B	Y-5M8M2R163024B	833
16	30	30	Y-5M8M2L163030B	Y-5M8M2R163030B	855
16	36	30	Y-5M8M2L163036B	Y-5M8M2R163036B	877
16	42	30	Y-5M8M2L163042B	Y-5M8M2R163042B	900
16	48	30	Y-5M8M2L163048B	Y-5M8M2R163048B	924
16	54	30	Y-5M8M2L163054B	Y-5M8M2R163054B	948
16	60	30	Y-5M8M2L163060B	Y-5M8M2R163060B	968

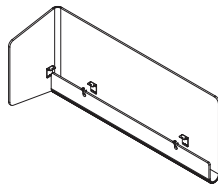

Left Hand

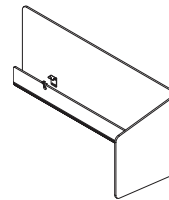

Right Hand

Specify

- Paint Selection
- Color Selection for PET - Lite Grey, Medium Grey, Tan or Vibrant Blue

Notes

- Specify based on table that enclosure is paired with.
- PET screen inserts are 1/2" (12mm) thick.
- 12" wide wings get one bracket, 18" wide and over wings get two brackets.
- 3/8" gap allows for installation of clamp-on monitors and accessories.
- Unhooks from worksurface for easy access to wire management. Access from user side.
- Height listed above is above surface height. For additional dimensions see product detail pages.

PET Nominal = Actual Size L-Wrap Enclosures with Wire Managers

Material	Where Used	Screen Type	Sized For	Mount Type	Handedness
PET	L-Wrap Partial Modesty on WS	Enclosure	L-Wrap for Nominal = Actual Size	Under Surface Mount	Left or Right

PET NOMINAL = ACTUAL SIZE L-WRAP ENCLOSURES WITH WIRE MANAGERS

H	W	D	Left Hand	Right Hand	List
			Model Number	Model Number	
20	24	12	Y-5M8M2L201224B	Y-5M8M2R201224B	795
20	30	12	Y-5M8M2L201230B	Y-5M8M2R201230B	819
20	36	12	Y-5M8M2L201236B	Y-5M8M2R201236B	843
20	42	12	Y-5M8M2L201242B	Y-5M8M2R201242B	866
20	48	12	Y-5M8M2L201248B	Y-5M8M2R201248B	888
20	54	12	Y-5M8M2L201254B	Y-5M8M2R201254B	912
20	60	12	Y-5M8M2L201260B	Y-5M8M2R201260B	937
20	66	12	Y-5M8M2L201266B	Y-5M8M2R201266B	960
20	72	12	Y-5M8M2L201272B	Y-5M8M2R201272B	985
20	78	12	Y-5M8M2L201278B	Y-5M8M2R201278B	1,007
20	24	18	Y-5M8M2L201824B	Y-5M8M2R201824B	819
20	30	18	Y-5M8M2L201830B	Y-5M8M2R201830B	843
20	36	18	Y-5M8M2L201836B	Y-5M8M2R201836B	866
20	42	18	Y-5M8M2L201842B	Y-5M8M2R201842B	888
20	48	18	Y-5M8M2L201848B	Y-5M8M2R201848B	912
20	54	18	Y-5M8M2L201854B	Y-5M8M2R201854B	937
20	60	18	Y-5M8M2L201860B	Y-5M8M2R201860B	960
20	66	18	Y-5M8M2L201866B	Y-5M8M2R201866B	985
20	72	18	Y-5M8M2L201872B	Y-5M8M2R201872B	1,007

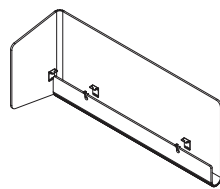

Left Hand

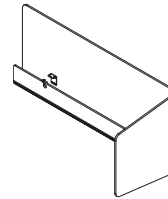

Right Hand

Specify

- Paint Selection
- Color Selection for PET - Lite Grey, Medium Grey, Tan or Vibrant Blue

Notes

- Specify based on table that enclosure is paired with.
- PET screen inserts are 1/2" (12mm) thick.
- 12" wide wings get one bracket, 18" wide and over wings get two brackets.
- 3/8" gap allows for installation of clamp-on monitors and accessories.
- Unhooks from worksurface for easy access to wire management. Access from user side.
- Height listed above is above surface height. For additional dimensions see product detail pages.

PET Nominal = Actual Size L-Wrap Enclosures with Wire Managers

Material	Where Used	Screen Type	Sized For	Mount Type	Handedness
PET	L-Wrap Partial Modesty on WS	Enclosure	L-Wrap for Nominal = Actual Size	Under Surface Mount	Left or Right

PET NOMINAL = ACTUAL SIZE L-WRAP ENCLOSURES WITH WIRE MANAGERS

H	W	D	Left Hand	Right Hand	List
			Model Number	Model Number	
20	24	24	Y-5M8M2L202424B	Y-5M8M2R202424B	843
20	30	24	Y-5M8M2L202430B	Y-5M8M2R202430B	866
20	36	24	Y-5M8M2L202436B	Y-5M8M2R202436B	888
20	42	24	Y-5M8M2L202442B	Y-5M8M2R202442B	912
20	48	24	Y-5M8M2L202448B	Y-5M8M2R202448B	937
20	54	24	Y-5M8M2L202454B	Y-5M8M2R202454B	960
20	60	24	Y-5M8M2L202460B	Y-5M8M2R202460B	985
20	66	24	Y-5M8M2L202466B	Y-5M8M2R202466B	1,007
20	24	30	Y-5M8M2L203024B	Y-5M8M2R203024B	866
20	30	30	Y-5M8M2L203030B	Y-5M8M2R203030B	888
20	36	30	Y-5M8M2L203036B	Y-5M8M2R203036B	912
20	42	30	Y-5M8M2L203042B	Y-5M8M2R203042B	937
20	48	30	Y-5M8M2L203048B	Y-5M8M2R203048B	960
20	54	30	Y-5M8M2L203054B	Y-5M8M2R203054B	985
20	60	30	Y-5M8M2L203060B	Y-5M8M2R203060B	1,007

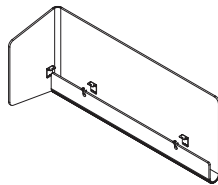

Left Hand

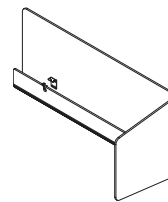

Right Hand

Specify

- Paint Selection
- Color Selection for PET - Lite Grey, Medium Grey, Tan or Vibrant Blue

Notes

- Specify based on table that enclosure is paired with.
- PET screen inserts are 1/2" (12mm) thick.
- 12" wide wings get one bracket, 18" wide and over wings get two brackets.
- 3/8" gap allows for installation of clamp-on monitors and accessories.
- Unhooks from worksurface for easy access to wire management. Access from user side.
- Height listed above is above surface height. For additional dimensions see product detail pages.

PET Nominal = Actual Size L-Wrap Enclosures with Wire Managers

Material	Where Used	Screen Type	Sized For	Mount Type	Handedness
PET	L-Wrap Partial Modesty on WS	Enclosure	L-Wrap for Nominal = Actual Size	Under Surface Mount	Left or Right

PET NOMINAL = ACTUAL SIZE L-WRAP ENCLOSURES WITH WIRE MANAGERS

H	W	D	Left Hand	Right Hand	List
			Model Number	Model Number	
24	24	12	Y-5M8M2L241224B	Y-5M8M2R241224B	877
24	30	12	Y-5M8M2L241230B	Y-5M8M2R241230B	918
24	36	12	Y-5M8M2L241236B	Y-5M8M2R241236B	961
24	42	12	Y-5M8M2L241242B	Y-5M8M2R241242B	1,003
24	48	12	Y-5M8M2L241248B	Y-5M8M2R241248B	1,046
24	54	12	Y-5M8M2L241254B	Y-5M8M2R241254B	1,087
24	60	12	Y-5M8M2L241260B	Y-5M8M2R241260B	1,128
24	66	12	Y-5M8M2L241266B	Y-5M8M2R241266B	1,169
24	72	12	Y-5M8M2L241272B	Y-5M8M2R241272B	1,210
24	78	12	Y-5M8M2L241278B	Y-5M8M2R241278B	1,253
24	24	18	Y-5M8M2L241824B	Y-5M8M2R241824B	918
24	30	18	Y-5M8M2L241830B	Y-5M8M2R241830B	961
24	36	18	Y-5M8M2L241836B	Y-5M8M2R241836B	1,003
24	42	18	Y-5M8M2L241842B	Y-5M8M2R241842B	1,046
24	48	18	Y-5M8M2L241848B	Y-5M8M2R241848B	1,087
24	54	18	Y-5M8M2L241854B	Y-5M8M2R241854B	1,128
24	60	18	Y-5M8M2L241860B	Y-5M8M2R241860B	1,169
24	66	18	Y-5M8M2L241866B	Y-5M8M2R241866B	1,210
24	72	18	Y-5M8M2L241872B	Y-5M8M2R241872B	1,253

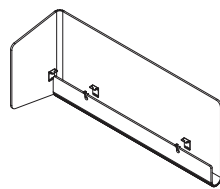

Left Hand

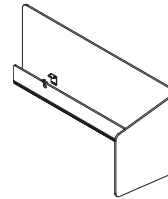

Right Hand

Specify

- Paint Selection
- Color Selection for PET - Lite Grey, Medium Grey, Tan or Vibrant Blue

Notes

- Specify based on table that enclosure is paired with.
- PET screen inserts are 1/2" (12mm) thick.
- 12" wide wings get one bracket, 18" wide and over wings get two brackets.
- 3/8" gap allows for installation of clamp-on monitors and accessories.
- Unhooks from worksurface for easy access to wire management. Access from user side.
- Height listed above is above surface height. For additional dimensions see product detail pages.

PET Nominal = Actual Size L-Wrap Enclosures with Wire Managers

Material	Where Used	Screen Type	Sized For	Mount Type	Handedness
PET	L-Wrap Partial Modesty on WS	Enclosure	L-Wrap for Nominal = Actual Size	Under Surface Mount	Left or Right

PET NOMINAL = ACTUAL SIZE L-WRAP ENCLOSURES WITH WIRE MANAGERS

H	W	D	Left Hand	Right Hand	List
			Model Number	Model Number	
24	24	24	Y-5M8M2L242424B	Y-5M8M2R242424B	961
24	30	24	Y-5M8M2L242430B	Y-5M8M2R242430B	1,003
24	36	24	Y-5M8M2L242436B	Y-5M8M2R242436B	1,046
24	42	24	Y-5M8M2L242442B	Y-5M8M2R242442B	1,087
24	48	24	Y-5M8M2L242448B	Y-5M8M2R242448B	1,128
24	54	24	Y-5M8M2L242454B	Y-5M8M2R242454B	1,169
24	60	24	Y-5M8M2L242460B	Y-5M8M2R242460B	1,210
24	66	24	Y-5M8M2L242466B	Y-5M8M2R242466B	1,253
24	24	30	Y-5M8M2L243024B	Y-5M8M2R243024B	1,003
24	30	30	Y-5M8M2L243030B	Y-5M8M2R243030B	1,046
24	36	30	Y-5M8M2L243036B	Y-5M8M2R243036B	1,087
24	42	30	Y-5M8M2L243042B	Y-5M8M2R243042B	1,128
24	48	30	Y-5M8M2L243048B	Y-5M8M2R243048B	1,169
24	54	30	Y-5M8M2L243054B	Y-5M8M2R243054B	1,210
24	60	30	Y-5M8M2L243060B	Y-5M8M2R243060B	1,253

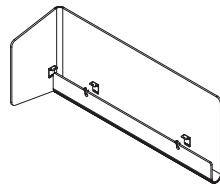

Left Hand

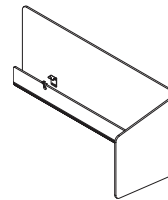

Right Hand

Specify

- Paint Selection
- Color Selection for PET - Lite Grey, Medium Grey, Tan or Vibrant Blue

Notes

- Specify based on table that enclosure is paired with.
- PET screen inserts are 1/2" (12mm) thick.
- 12" wide wings get one bracket, 18" wide and over wings get two brackets.
- 3/8" gap allows for installation of clamp-on monitors and accessories.
- Unhooks from worksurface for easy access to wire management. Access from user side.
- Height listed above is above surface height. For additional dimensions see product detail pages.

PET Nominal = Actual Size L-Wrap Enclosures with Wire Managers

Material	Where Used	Screen Type	Sized For	Mount Type	Handedness
PET	L-Wrap Partial Modesty on WS	Enclosure	L-Wrap for Nominal = Actual Size	Under Surface Mount	Left or Right

PET NOMINAL = ACTUAL SIZE L-WRAP ENCLOSURES WITH WIRE MANAGERS

H	W	D	Left Hand	Right Hand	List
			Model Number	Model Number	
28	24	12	Y-5M8M2L281224B	Y-5M8M2R281224B	909
28	30	12	Y-5M8M2L281230B	Y-5M8M2R281230B	954
28	36	12	Y-5M8M2L281236B	Y-5M8M2R281236B	1,001
28	42	12	Y-5M8M2L281242B	Y-5M8M2R281242B	1,047
28	48	12	Y-5M8M2L281248B	Y-5M8M2R281248B	1,093
28	54	12	Y-5M8M2L281254B	Y-5M8M2R281254B	1,140
28	60	12	Y-5M8M2L281260B	Y-5M8M2R281260B	1,184
28	66	12	Y-5M8M2L281266B	Y-5M8M2R281266B	1,234
28	72	12	Y-5M8M2L281272B	Y-5M8M2R281272B	1,280
28	78	12	Y-5M8M2L281278B	Y-5M8M2R281278B	1,327
28	24	18	Y-5M8M2L281824B	Y-5M8M2R281824B	954
28	30	18	Y-5M8M2L281830B	Y-5M8M2R281830B	1,001
28	36	18	Y-5M8M2L281836B	Y-5M8M2R281836B	1,047
28	42	18	Y-5M8M2L281842B	Y-5M8M2R281842B	1,093
28	48	18	Y-5M8M2L281848B	Y-5M8M2R281848B	1,140
28	54	18	Y-5M8M2L281854B	Y-5M8M2R281854B	1,184
28	60	18	Y-5M8M2L281860B	Y-5M8M2R281860B	1,234
28	66	18	Y-5M8M2L281866B	Y-5M8M2R281866B	1,280
28	72	18	Y-5M8M2L281872B	Y-5M8M2R281872B	1,327

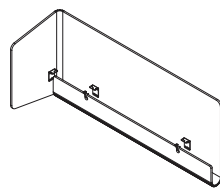

Left Hand

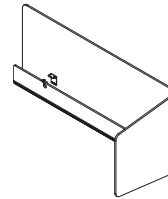

Right Hand

Specify

- Paint Selection
- Color Selection for PET - Lite Grey, Medium Grey, Tan or Vibrant Blue

Notes

- Specify based on table that enclosure is paired with.
- PET screen inserts are 1/2" (12mm) thick.
- 12" wide wings get one bracket, 18" wide and over wings get two brackets.
- 3/8" gap allows for installation of clamp-on monitors and accessories.
- Unhooks from worksurface for easy access to wire management. Access from user side.
- Height listed above is above surface height. For additional dimensions see product detail pages.

PET Nominal = Actual Size L-Wrap Enclosures with Wire Managers

Material	Where Used	Screen Type	Sized For	Mount Type	Handedness
PET	L-Wrap Partial Modesty on WS	Enclosure	L-Wrap for Nominal = Actual Size	Under Surface Mount	Left or Right

PET NOMINAL = ACTUAL SIZE L-WRAP ENCLOSURES WITH WIRE MANAGERS

H	W	D	Left Hand	Right Hand	List
			Model Number	Model Number	
28	24	24	Y-5M8M2L282424B	Y-5M8M2R282424B	1,001
28	30	24	Y-5M8M2L282430B	Y-5M8M2R282430B	1,047
28	36	24	Y-5M8M2L282436B	Y-5M8M2R282436B	1,093
28	42	24	Y-5M8M2L282442B	Y-5M8M2R282442B	1,140
28	48	24	Y-5M8M2L282448B	Y-5M8M2R282448B	1,184
28	54	24	Y-5M8M2L282454B	Y-5M8M2R282454B	1,234
28	60	24	Y-5M8M2L282460B	Y-5M8M2R282460B	1,280
28	66	24	Y-5M8M2L282466B	Y-5M8M2R282466B	1,327
28	24	30	Y-5M8M2L283024B	Y-5M8M2R283024B	1,047
28	30	30	Y-5M8M2L283030B	Y-5M8M2R283030B	1,093
28	36	30	Y-5M8M2L283036B	Y-5M8M2R283036B	1,140
28	42	30	Y-5M8M2L283042B	Y-5M8M2R283042B	1,184
28	48	30	Y-5M8M2L283048B	Y-5M8M2R283048B	1,234
28	54	30	Y-5M8M2L283054B	Y-5M8M2R283054B	1,280
28	60	30	Y-5M8M2L283060B	Y-5M8M2R283060B	1,327

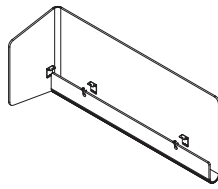

Left Hand

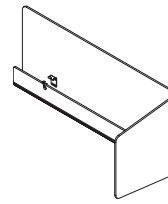

Right Hand

Specify

- Paint Selection
- Color Selection for PET - Lite Grey, Medium Grey, Tan or Vibrant Blue

Notes

- Specify based on table that enclosure is paired with.
- PET screen inserts are 1/2" (12mm) thick.
- 12" wide wings get one bracket, 18" wide and over wings get two brackets.
- 3/8" gap allows for installation of clamp-on monitors and accessories.
- Unhooks from worksurface for easy access to wire management. Access from user side.
- Height listed above is above surface height. For additional dimensions see product detail pages.

PET Day-to-Day, Calibrate & E-Series HAT L-Wrap Enclosures with Wire Managers

Material	Where Used	Screen Type	Sized For	Mount Type	Handedness
PET	L-Wrap Partial Modesty on WS	Enclosure	L-Wrap for Day-to-Day, Calibrate & E-Series HAT	Under Surface Mount	Left or Right

PET DAY-TO-DAY, CALIBRATE & E-SERIES HAT L-WRAP ENCLOSURES WITH WIRE MANAGERS

H	W	D	Left Hand	Right Hand	List
			Model Number	Model Number	
3	24	12	Y-5M8J2L031224B	Y-5M8J2R031224B	714
3	30	12	Y-5M8J2L031230B	Y-5M8J2R031230B	733
3	36	12	Y-5M8J2L031236B	Y-5M8J2R031236B	750
3	42	12	Y-5M8J2L031242B	Y-5M8J2R031242B	768
3	48	12	Y-5M8J2L031248B	Y-5M8J2R031248B	788
3	54	12	Y-5M8J2L031254B	Y-5M8J2R031254B	806
3	60	12	Y-5M8J2L031260B	Y-5M8J2R031260B	825
3	66	12	Y-5M8J2L031266B	Y-5M8J2R031266B	843
3	72	12	Y-5M8J2L031272B	Y-5M8J2R031272B	860
3	78	12	Y-5M8J2L031278B	Y-5M8J2R031278B	880
3	24	18	Y-5M8J2L031824B	Y-5M8J2R031824B	733
3	30	18	Y-5M8J2L031830B	Y-5M8J2R031830B	750
3	36	18	Y-5M8J2L031836B	Y-5M8J2R031836B	768
3	42	18	Y-5M8J2L031842B	Y-5M8J2R031842B	788
3	48	18	Y-5M8J2L031848B	Y-5M8J2R031848B	806
3	54	18	Y-5M8J2L031854B	Y-5M8J2R031854B	825
3	60	18	Y-5M8J2L031860B	Y-5M8J2R031860B	843
3	66	18	Y-5M8J2L031866B	Y-5M8J2R031866B	860
3	72	18	Y-5M8J2L031872B	Y-5M8J2R031872B	880

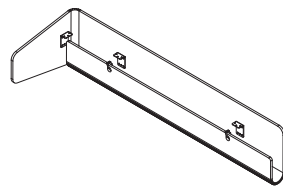

Left Hand

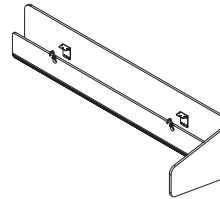

Right Hand

Specify

- Paint Selection
- Color Selection for PET - Lite Grey, Medium Grey, Tan or Vibrant Blue

Notes

- Specify based on table that enclosure is paired with.
- PET screen inserts are 1/2" (12mm) thick.
- 12" wide wings get one bracket, 18" wide and over wings get two brackets.
- 3/8" gap allows for installation of clamp-on monitors and accessories.
- Unhooks from worksurface for easy access to wire management. Access from user side.
- Height listed above is above surface height. For additional dimensions see product detail pages.

PET Day-to-Day, Calibrate & E-Series HAT L-Wrap Enclosures with Wire Managers

Material	Where Used	Screen Type	Sized For	Mount Type	Handedness
PET	L-Wrap Partial Modesty on WS	Enclosure	L-Wrap for Day-to-Day, Calibrate & E-Series HAT	Under Surface Mount	Left or Right

PET DAY-TO-DAY, CALIBRATE & E-SERIES HAT L-WRAP ENCLOSURES WITH WIRE MANAGERS

H	W	D	Left Hand	Right Hand	List
			Model Number	Model Number	
3	24	24	Y-5M8J2L032424B	Y-5M8J2R032424B	750
3	30	24	Y-5M8J2L032430B	Y-5M8J2R032430B	768
3	36	24	Y-5M8J2L032436B	Y-5M8J2R032436B	788
3	42	24	Y-5M8J2L032442B	Y-5M8J2R032442B	806
3	48	24	Y-5M8J2L032448B	Y-5M8J2R032448B	825
3	54	24	Y-5M8J2L032454B	Y-5M8J2R032454B	843
3	60	24	Y-5M8J2L032460B	Y-5M8J2R032460B	860
3	66	24	Y-5M8J2L032466B	Y-5M8J2R032466B	880
3	24	30	Y-5M8J2L033024B	Y-5M8J2R033024B	768
3	30	30	Y-5M8J2L033030B	Y-5M8J2R033030B	788
3	36	30	Y-5M8J2L033036B	Y-5M8J2R033036B	806
3	42	30	Y-5M8J2L033042B	Y-5M8J2R033042B	825
3	48	30	Y-5M8J2L033048B	Y-5M8J2R033048B	843
3	54	30	Y-5M8J2L033054B	Y-5M8J2R033054B	860
3	60	30	Y-5M8J2L033060B	Y-5M8J2R033060B	880

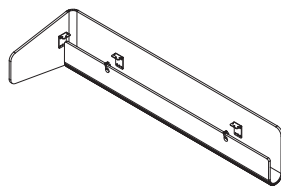

Left Hand

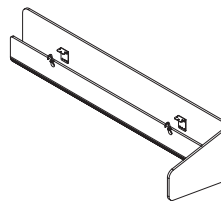

Right Hand

Specify

- Paint Selection
- Color Selection for PET - Lite Grey, Medium Grey, Tan or Vibrant Blue

Notes

- Specify based on table that enclosure is paired with.
- PET screen inserts are 1/2" (12mm) thick.
- 12" wide wings get one bracket, 18" wide and over wings get two brackets.
- 3/8" gap allows for installation of clamp-on monitors and accessories.
- Unhooks from worksurface for easy access to wire management. Access from user side.
- Height listed above is above surface height. For additional dimensions see product detail pages.

PET Day-to-Day, Calibrate & E-Series HAT L-Wrap Enclosures with Wire Managers

Material	Where Used	Screen Type	Sized For	Mount Type	Handedness
PET	L-Wrap Partial Modesty on WS	Enclosure	L-Wrap for Day-to-Day, Calibrate & E-Series HAT	Under Surface Mount	Left or Right

PET DAY-TO-DAY, CALIBRATE & E-SERIES HAT L-WRAP ENCLOSURES WITH WIRE MANAGERS

H	W	D	Left Hand	Right Hand	List
			Model Number	Model Number	
12	24	12	Y-5M8J2L121224B	Y-5M8J2R121224B	744
12	30	12	Y-5M8J2L121230B	Y-5M8J2R121230B	763
12	36	12	Y-5M8J2L121236B	Y-5M8J2R121236B	782
12	42	12	Y-5M8J2L121242B	Y-5M8J2R121242B	801
12	48	12	Y-5M8J2L121248B	Y-5M8J2R121248B	820
12	54	12	Y-5M8J2L121254B	Y-5M8J2R121254B	839
12	60	12	Y-5M8J2L121260B	Y-5M8J2R121260B	858
12	66	12	Y-5M8J2L121266B	Y-5M8J2R121266B	877
12	72	12	Y-5M8J2L121272B	Y-5M8J2R121272B	897
12	78	12	Y-5M8J2L121278B	Y-5M8J2R121278B	916
12	24	18	Y-5M8J2L121824B	Y-5M8J2R121824B	763
12	30	18	Y-5M8J2L121830B	Y-5M8J2R121830B	782
12	36	18	Y-5M8J2L121836B	Y-5M8J2R121836B	801
12	42	18	Y-5M8J2L121842B	Y-5M8J2R121842B	820
12	48	18	Y-5M8J2L121848B	Y-5M8J2R121848B	839
12	54	18	Y-5M8J2L121854B	Y-5M8J2R121854B	858
12	60	18	Y-5M8J2L121860B	Y-5M8J2R121860B	877
12	66	18	Y-5M8J2L121866B	Y-5M8J2R121866B	897
12	72	18	Y-5M8J2L121872B	Y-5M8J2R121872B	916

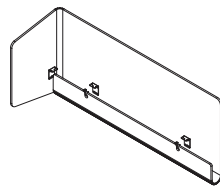

Left Hand

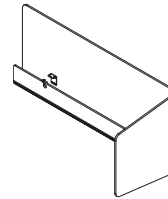

Right Hand

Specify

- Paint Selection
- Color Selection for PET - Lite Grey, Medium Grey, Tan or Vibrant Blue

Notes

- Specify based on table that enclosure is paired with.
- PET screen inserts are 1/2" (12mm) thick.
- 12" wide wings get one bracket, 18" wide and over wings get two brackets.
- 3/8" gap allows for installation of clamp-on monitors and accessories.
- Unhooks from worksurface for easy access to wire management. Access from user side.
- Height listed above is above surface height. For additional dimensions see product detail pages.

PET Day-to-Day, Calibrate & E-Series HAT L-Wrap Enclosures with Wire Managers

Material	Where Used	Screen Type	Sized For	Mount Type	Handedness
PET	L-Wrap Partial Modesty on WS	Enclosure	L-Wrap for Day-to-Day, Calibrate & E-Series HAT	Under Surface Mount	Left or Right

PET DAY-TO-DAY, CALIBRATE & E-SERIES HAT L-WRAP ENCLOSURES WITH WIRE MANAGERS

H	W	D	Left Hand	Right Hand	List
			Model Number	Model Number	
12	24	24	Y-5M8J2L122424B	Y-5M8J2R122424B	782
12	30	24	Y-5M8J2L122430B	Y-5M8J2R122430B	801
12	36	24	Y-5M8J2L122436B	Y-5M8J2R122436B	820
12	42	24	Y-5M8J2L122442B	Y-5M8J2R122442B	839
12	48	24	Y-5M8J2L122448B	Y-5M8J2R122448B	858
12	54	24	Y-5M8J2L122454B	Y-5M8J2R122454B	877
12	60	24	Y-5M8J2L122460B	Y-5M8J2R122460B	897
12	66	24	Y-5M8J2L122466B	Y-5M8J2R122466B	916
12	24	30	Y-5M8J2L123024B	Y-5M8J2R123024B	801
12	30	30	Y-5M8J2L123030B	Y-5M8J2R123030B	820
12	36	30	Y-5M8J2L123036B	Y-5M8J2R123036B	839
12	42	30	Y-5M8J2L123042B	Y-5M8J2R123042B	858
12	48	30	Y-5M8J2L123048B	Y-5M8J2R123048B	877
12	54	30	Y-5M8J2L123054B	Y-5M8J2R123054B	897
12	60	30	Y-5M8J2L123060B	Y-5M8J2R123060B	916

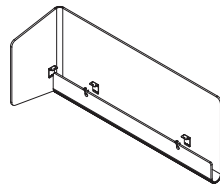

Left Hand

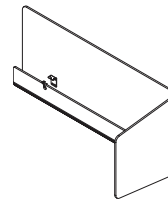

Right Hand

Specify

- Paint Selection
- Color Selection for PET - Lite Grey, Medium Grey, Tan or Vibrant Blue

Notes

- Specify based on table that enclosure is paired with.
- PET screen inserts are 1/2" (12mm) thick.
- 12" wide wings get one bracket, 18" wide and over wings get two brackets.
- 3/8" gap allows for installation of clamp-on monitors and accessories.
- Unhooks from worksurface for easy access to wire management. Access from user side.
- Height listed above is above surface height. For additional dimensions see product detail pages.

PET Day-to-Day, Calibrate & E-Series HAT L-Wrap Enclosures with Wire Managers

Material	Where Used	Screen Type	Sized For	Mount Type	Handedness
PET	L-Wrap Partial Modesty on WS	Enclosure	L-Wrap for Day-to-Day, Calibrate & E-Series HAT	Under Surface Mount	Left or Right

PET DAY-TO-DAY, CALIBRATE & E-SERIES HAT L-WRAP ENCLOSURES WITH WIRE MANAGERS

H	W	D	Left Hand	Right Hand	List
			Model Number	Model Number	
16	24	12	Y-5M8J2L161224B	Y-5M8J2R161224B	765
16	30	12	Y-5M8J2L161230B	Y-5M8J2R161230B	788
16	36	12	Y-5M8J2L161236B	Y-5M8J2R161236B	809
16	42	12	Y-5M8J2L161242B	Y-5M8J2R161242B	833
16	48	12	Y-5M8J2L161248B	Y-5M8J2R161248B	855
16	54	12	Y-5M8J2L161254B	Y-5M8J2R161254B	877
16	60	12	Y-5M8J2L161260B	Y-5M8J2R161260B	900
16	66	12	Y-5M8J2L161266B	Y-5M8J2R161266B	924
16	72	12	Y-5M8J2L161272B	Y-5M8J2R161272B	948
16	78	12	Y-5M8J2L161278B	Y-5M8J2R161278B	968
16	24	18	Y-5M8J2L161824B	Y-5M8J2R161824B	788
16	30	18	Y-5M8J2L161830B	Y-5M8J2R161830B	809
16	36	18	Y-5M8J2L161836B	Y-5M8J2R161836B	833
16	42	18	Y-5M8J2L161842B	Y-5M8J2R161842B	855
16	48	18	Y-5M8J2L161848B	Y-5M8J2R161848B	877
16	54	18	Y-5M8J2L161854B	Y-5M8J2R161854B	900
16	60	18	Y-5M8J2L161860B	Y-5M8J2R161860B	924
16	66	18	Y-5M8J2L161866B	Y-5M8J2R161866B	948
16	72	18	Y-5M8J2L161872B	Y-5M8J2R161872B	968

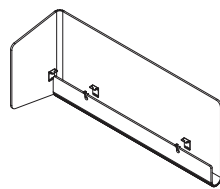

Left Hand

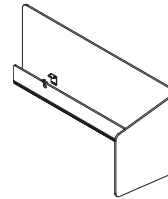

Right Hand

Specify

- Paint Selection
- Color Selection for PET - Lite Grey, Medium Grey, Tan or Vibrant Blue

Notes

- Specify based on table that enclosure is paired with.
- PET screen inserts are 1/2" (12mm) thick.
- 12" wide wings get one bracket, 18" wide and over wings get two brackets.
- 3/8" gap allows for installation of clamp-on monitors and accessories.
- Unhooks from worksurface for easy access to wire management. Access from user side.
- Height listed above is above surface height. For additional dimensions see product detail pages.

PET Day-to-Day, Calibrate & E-Series HAT L-Wrap Enclosures with Wire Managers

Material	Where Used	Screen Type	Sized For	Mount Type	Handedness
PET	L-Wrap Partial Modesty on WS	Enclosure	L-Wrap for Day-to-Day, Calibrate & E-Series HAT	Under Surface Mount	Left or Right

PET DAY-TO-DAY, CALIBRATE & E-SERIES HAT L-WRAP ENCLOSURES WITH WIRE MANAGERS

H	W	D	Left Hand	Right Hand	List
			Model Number	Model Number	
16	24	24	Y-5M8J2L162424B	Y-5M8J2R162424B	809
16	30	24	Y-5M8J2L162430B	Y-5M8J2R162430B	833
16	36	24	Y-5M8J2L162436B	Y-5M8J2R162436B	855
16	42	24	Y-5M8J2L162442B	Y-5M8J2R162442B	877
16	48	24	Y-5M8J2L162448B	Y-5M8J2R162448B	900
16	54	24	Y-5M8J2L162454B	Y-5M8J2R162454B	924
16	60	24	Y-5M8J2L162460B	Y-5M8J2R162460B	948
16	66	24	Y-5M8J2L162466B	Y-5M8J2R162466B	968
16	24	30	Y-5M8J2L163024B	Y-5M8J2R163024B	833
16	30	30	Y-5M8J2L163030B	Y-5M8J2R163030B	855
16	36	30	Y-5M8J2L163036B	Y-5M8J2R163036B	877
16	42	30	Y-5M8J2L163042B	Y-5M8J2R163042B	900
16	48	30	Y-5M8J2L163048B	Y-5M8J2R163048B	924
16	54	30	Y-5M8J2L163054B	Y-5M8J2R163054B	948
16	60	30	Y-5M8J2L163060B	Y-5M8J2R163060B	968

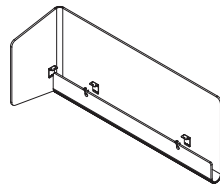

Left Hand

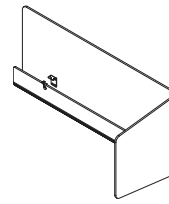

Right Hand

Specify

- Paint Selection
- Color Selection for PET - Lite Grey, Medium Grey, Tan or Vibrant Blue

Notes

- Specify based on table that enclosure is paired with.
- PET screen inserts are 1/2" (12mm) thick.
- 12" wide wings get one bracket, 18" wide and over wings get two brackets.
- 3/8" gap allows for installation of clamp-on monitors and accessories.
- Unhooks from worksurface for easy access to wire management. Access from user side.
- Height listed above is above surface height. For additional dimensions see product detail pages.

PET Day-to-Day, Calibrate & E-Series HAT L-Wrap Enclosures with Wire Managers

Material	Where Used	Screen Type	Sized For	Mount Type	Handedness
PET	L-Wrap Partial Modesty on WS	Enclosure	L-Wrap for Day-to-Day, Calibrate & E-Series HAT	Under Surface Mount	Left or Right

PET DAY-TO-DAY, CALIBRATE & E-SERIES HAT L-WRAP ENCLOSURES WITH WIRE MANAGERS

H	W	D	Left Hand	Right Hand	List
			Model Number	Model Number	
20	24	12	Y-5M8J2L201224B	Y-5M8J2R201224B	795
20	30	12	Y-5M8J2L201230B	Y-5M8J2R201230B	819
20	36	12	Y-5M8J2L201236B	Y-5M8J2R201236B	843
20	42	12	Y-5M8J2L201242B	Y-5M8J2R201242B	866
20	48	12	Y-5M8J2L201248B	Y-5M8J2R201248B	888
20	54	12	Y-5M8J2L201254B	Y-5M8J2R201254B	912
20	60	12	Y-5M8J2L201260B	Y-5M8J2R201260B	937
20	66	12	Y-5M8J2L201266B	Y-5M8J2R201266B	960
20	72	12	Y-5M8J2L201272B	Y-5M8J2R201272B	985
20	78	12	Y-5M8J2L201278B	Y-5M8J2R201278B	1,007
20	24	18	Y-5M8J2L201824B	Y-5M8J2R201824B	819
20	30	18	Y-5M8J2L201830B	Y-5M8J2R201830B	843
20	36	18	Y-5M8J2L201836B	Y-5M8J2R201836B	866
20	42	18	Y-5M8J2L201842B	Y-5M8J2R201842B	888
20	48	18	Y-5M8J2L201848B	Y-5M8J2R201848B	912
20	54	18	Y-5M8J2L201854B	Y-5M8J2R201854B	937
20	60	18	Y-5M8J2L201860B	Y-5M8J2R201860B	960
20	66	18	Y-5M8J2L201866B	Y-5M8J2R201866B	985
20	72	18	Y-5M8J2L201872B	Y-5M8J2R201872B	1,007

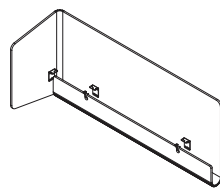

Left Hand

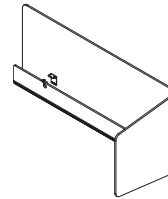

Right Hand

Specify

- Paint Selection
- Color Selection for PET - Lite Grey, Medium Grey, Tan or Vibrant Blue

Notes

- Specify based on table that enclosure is paired with.
- PET screen inserts are 1/2" (12mm) thick.
- 12" wide wings get one bracket, 18" wide and over wings get two brackets.
- 3/8" gap allows for installation of clamp-on monitors and accessories.
- Unhooks from worksurface for easy access to wire management. Access from user side.
- Height listed above is above surface height. For additional dimensions see product detail pages.

PET Day-to-Day, Calibrate & E-Series HAT L-Wrap Enclosures with Wire Managers

Material	Where Used	Screen Type	Sized For	Mount Type	Handedness
PET	L-Wrap Partial Modesty on WS	Enclosure	L-Wrap for Day-to-Day, Calibrate & E-Series HAT	Under Surface Mount	Left or Right

PET DAY-TO-DAY, CALIBRATE & E-SERIES HAT L-WRAP ENCLOSURES WITH WIRE MANAGERS

H	W	D	Left Hand	Right Hand	List
			Model Number	Model Number	
20	24	24	Y-5M8J2L202424B	Y-5M8J2R202424B	843
20	30	24	Y-5M8J2L202430B	Y-5M8J2R202430B	866
20	36	24	Y-5M8J2L202436B	Y-5M8J2R202436B	888
20	42	24	Y-5M8J2L202442B	Y-5M8J2R202442B	912
20	48	24	Y-5M8J2L202448B	Y-5M8J2R202448B	937
20	54	24	Y-5M8J2L202454B	Y-5M8J2R202454B	960
20	60	24	Y-5M8J2L202460B	Y-5M8J2R202460B	985
20	66	24	Y-5M8J2L202466B	Y-5M8J2R202466B	1,007
20	24	30	Y-5M8J2L203024B	Y-5M8J2R203024B	866
20	30	30	Y-5M8J2L203030B	Y-5M8J2R203030B	888
20	36	30	Y-5M8J2L203036B	Y-5M8J2R203036B	912
20	42	30	Y-5M8J2L203042B	Y-5M8J2R203042B	937
20	48	30	Y-5M8J2L203048B	Y-5M8J2R203048B	960
20	54	30	Y-5M8J2L203054B	Y-5M8J2R203054B	985
20	60	30	Y-5M8J2L203060B	Y-5M8J2R203060B	1,007

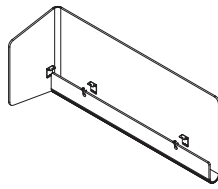

Left Hand

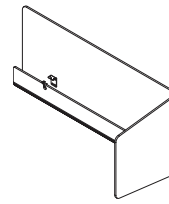

Right Hand

Specify

- Paint Selection
- Color Selection for PET - Lite Grey, Medium Grey, Tan or Vibrant Blue

Notes

- Specify based on table that enclosure is paired with.
- PET screen inserts are 1/2" (12mm) thick.
- 12" wide wings get one bracket, 18" wide and over wings get two brackets.
- 3/8" gap allows for installation of clamp-on monitors and accessories.
- Unhooks from worksurface for easy access to wire management. Access from user side.
- Height listed above is above surface height. For additional dimensions see product detail pages.

PET Day-to-Day, Calibrate & E-Series HAT L-Wrap Enclosures with Wire Managers

Material	Where Used	Screen Type	Sized For	Mount Type	Handedness
PET	L-Wrap Partial Modesty on WS	Enclosure	L-Wrap for Day-to-Day, Calibrate & E-Series HAT	Under Surface Mount	Left or Right

PET DAY-TO-DAY, CALIBRATE & E-SERIES HAT L-WRAP ENCLOSURES WITH WIRE MANAGERS

H	W	D	Left Hand	Right Hand	List
			Model Number	Model Number	
24	24	12	Y-5M8J2L241224B	Y-5M8J2R241224B	877
24	30	12	Y-5M8J2L241230B	Y-5M8J2R241230B	918
24	36	12	Y-5M8J2L241236B	Y-5M8J2R241236B	961
24	42	12	Y-5M8J2L241242B	Y-5M8J2R241242B	1,003
24	48	12	Y-5M8J2L241248B	Y-5M8J2R241248B	1,046
24	54	12	Y-5M8J2L241254B	Y-5M8J2R241254B	1,087
24	60	12	Y-5M8J2L241260B	Y-5M8J2R241260B	1,128
24	66	12	Y-5M8J2L241266B	Y-5M8J2R241266B	1,169
24	72	12	Y-5M8J2L241272B	Y-5M8J2R241272B	1,210
24	78	12	Y-5M8J2L241278B	Y-5M8J2R241278B	1,253
24	24	18	Y-5M8J2L241824B	Y-5M8J2R241824B	918
24	30	18	Y-5M8J2L241830B	Y-5M8J2R241830B	961
24	36	18	Y-5M8J2L241836B	Y-5M8J2R241836B	1,003
24	42	18	Y-5M8J2L241842B	Y-5M8J2R241842B	1,046
24	48	18	Y-5M8J2L241848B	Y-5M8J2R241848B	1,087
24	54	18	Y-5M8J2L241854B	Y-5M8J2R241854B	1,128
24	60	18	Y-5M8J2L241860B	Y-5M8J2R241860B	1,169
24	66	18	Y-5M8J2L241866B	Y-5M8J2R241866B	1,210
24	72	18	Y-5M8J2L241872B	Y-5M8J2R241872B	1,253

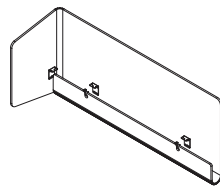

Left Hand

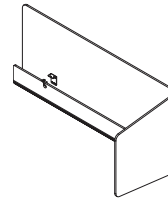

Right Hand

Specify

- Paint Selection
- Color Selection for PET - Lite Grey, Medium Grey, Tan or Vibrant Blue

Notes

- Specify based on table that enclosure is paired with.
- PET screen inserts are 1/2" (12mm) thick.
- 12" wide wings get one bracket, 18" wide and over wings get two brackets.
- 3/8" gap allows for installation of clamp-on monitors and accessories.
- Unhooks from worksurface for easy access to wire management. Access from user side.
- Height listed above is above surface height. For additional dimensions see product detail pages.

PET Day-to-Day, Calibrate & E-Series HAT L-Wrap Enclosures with Wire Managers

Material	Where Used	Screen Type	Sized For	Mount Type	Handedness
PET	L-Wrap Partial Modesty on WS	Enclosure	L-Wrap for Day-to-Day, Calibrate & E-Series HAT	Under Surface Mount	Left or Right

PET DAY-TO-DAY, CALIBRATE & E-SERIES HAT L-WRAP ENCLOSURES WITH WIRE MANAGERS

H	W	D	Left Hand	Right Hand	List
			Model Number	Model Number	
24	24	24	Y-5M8J2L242424B	Y-5M8J2R242424B	961
24	30	24	Y-5M8J2L242430B	Y-5M8J2R242430B	1,003
24	36	24	Y-5M8J2L242436B	Y-5M8J2R242436B	1,046
24	42	24	Y-5M8J2L242442B	Y-5M8J2R242442B	1,087
24	48	24	Y-5M8J2L242448B	Y-5M8J2R242448B	1,128
24	54	24	Y-5M8J2L242454B	Y-5M8J2R242454B	1,169
24	60	24	Y-5M8J2L242460B	Y-5M8J2R242460B	1,210
24	66	24	Y-5M8J2L242466B	Y-5M8J2R242466B	1,253
24	24	30	Y-5M8J2L243024B	Y-5M8J2R243024B	1,003
24	30	30	Y-5M8J2L243030B	Y-5M8J2R243030B	1,046
24	36	30	Y-5M8J2L243036B	Y-5M8J2R243036B	1,087
24	42	30	Y-5M8J2L243042B	Y-5M8J2R243042B	1,128
24	48	30	Y-5M8J2L243048B	Y-5M8J2R243048B	1,169
24	54	30	Y-5M8J2L243054B	Y-5M8J2R243054B	1,210
24	60	30	Y-5M8J2L243060B	Y-5M8J2R243060B	1,253

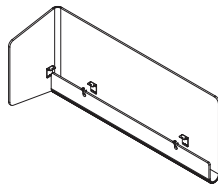

Left Hand

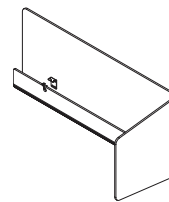

Right Hand

Specify

- Paint Selection
- Color Selection for PET - Lite Grey, Medium Grey, Tan or Vibrant Blue

Notes

- Specify based on table that enclosure is paired with.
- PET screen inserts are 1/2" (12mm) thick.
- 12" wide wings get one bracket, 18" wide and over wings get two brackets.
- 3/8" gap allows for installation of clamp-on monitors and accessories.
- Unhooks from worksurface for easy access to wire management. Access from user side.
- Height listed above is above surface height. For additional dimensions see product detail pages.

PET Day-to-Day, Calibrate & E-Series HAT L-Wrap Enclosures with Wire Managers

Material	Where Used	Screen Type	Sized For	Mount Type	Handedness
PET	L-Wrap Partial Modesty on WS	Enclosure	L-Wrap for Day-to-Day, Calibrate & E-Series HAT	Under Surface Mount	Left or Right

PET DAY-TO-DAY, CALIBRATE & E-SERIES HAT L-WRAP ENCLOSURES WITH WIRE MANAGERS

H	W	D	Left Hand	Right Hand	List
			Model Number	Model Number	
28	24	12	Y-5M8J2L281224B	Y-5M8J2R281224B	909
28	30	12	Y-5M8J2L281230B	Y-5M8J2R281230B	954
28	36	12	Y-5M8J2L281236B	Y-5M8J2R281236B	1,001
28	42	12	Y-5M8J2L281242B	Y-5M8J2R281242B	1,047
28	48	12	Y-5M8J2L281248B	Y-5M8J2R281248B	1,093
28	54	12	Y-5M8J2L281254B	Y-5M8J2R281254B	1,140
28	60	12	Y-5M8J2L281260B	Y-5M8J2R281260B	1,184
28	66	12	Y-5M8J2L281266B	Y-5M8J2R281266B	1,234
28	72	12	Y-5M8J2L281272B	Y-5M8J2R281272B	1,280
28	78	12	Y-5M8J2L281278B	Y-5M8J2R281278B	1,327
28	24	18	Y-5M8J2L281824B	Y-5M8J2R281824B	954
28	30	18	Y-5M8J2L281830B	Y-5M8J2R281830B	1,001
28	36	18	Y-5M8J2L281836B	Y-5M8J2R281836B	1,047
28	42	18	Y-5M8J2L281842B	Y-5M8J2R281842B	1,093
28	48	18	Y-5M8J2L281848B	Y-5M8J2R281848B	1,140
28	54	18	Y-5M8J2L281854B	Y-5M8J2R281854B	1,184
28	60	18	Y-5M8J2L281860B	Y-5M8J2R281860B	1,234
28	66	18	Y-5M8J2L281866B	Y-5M8J2R281866B	1,280
28	72	18	Y-5M8J2L281872B	Y-5M8J2R281872B	1,327

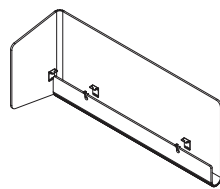

Left Hand

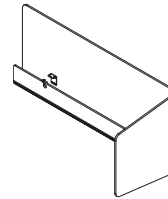

Right Hand

Specify

- Paint Selection
- Color Selection for PET - Lite Grey, Medium Grey, Tan or Vibrant Blue

Notes

- Specify based on table that enclosure is paired with.
- PET screen inserts are 1/2" (12mm) thick.
- 12" wide wings get one bracket, 18" wide and over wings get two brackets.
- 3/8" gap allows for installation of clamp-on monitors and accessories.
- Unhooks from worksurface for easy access to wire management. Access from user side.
- Height listed above is above surface height. For additional dimensions see product detail pages.

PET Day-to-Day, Calibrate & E-Series HAT L-Wrap Enclosures with Wire Managers

Material	Where Used	Screen Type	Sized For	Mount Type	Handedness
PET	L-Wrap Partial Modesty on WS	Enclosure	L-Wrap for Day-to-Day, Calibrate & E-Series HAT	Under Surface Mount	Left or Right

PET DAY-TO-DAY, CALIBRATE & E-SERIES HAT L-WRAP ENCLOSURES WITH WIRE MANAGERS

H	W	D	Left Hand	Right Hand	List
			Model Number	Model Number	
28	24	24	Y-5M8J2L282424B	Y-5M8J2R282424B	1,001
28	30	24	Y-5M8J2L282430B	Y-5M8J2R282430B	1,047
28	36	24	Y-5M8J2L282436B	Y-5M8J2R282436B	1,093
28	42	24	Y-5M8J2L282442B	Y-5M8J2R282442B	1,140
28	48	24	Y-5M8J2L282448B	Y-5M8J2R282448B	1,184
28	54	24	Y-5M8J2L282454B	Y-5M8J2R282454B	1,234
28	60	24	Y-5M8J2L282460B	Y-5M8J2R282460B	1,280
28	66	24	Y-5M8J2L282466B	Y-5M8J2R282466B	1,327
28	24	30	Y-5M8J2L283024B	Y-5M8J2R283024B	1,047
28	30	30	Y-5M8J2L283030B	Y-5M8J2R283030B	1,093
28	36	30	Y-5M8J2L283036B	Y-5M8J2R283036B	1,140
28	42	30	Y-5M8J2L283042B	Y-5M8J2R283042B	1,184
28	48	30	Y-5M8J2L283048B	Y-5M8J2R283048B	1,234
28	54	30	Y-5M8J2L283054B	Y-5M8J2R283054B	1,280
28	60	30	Y-5M8J2L283060B	Y-5M8J2R283060B	1,327

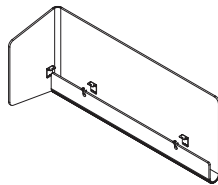

Left Hand

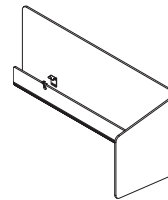

Right Hand

Specify

- Paint Selection
- Color Selection for PET - Lite Grey, Medium Grey, Tan or Vibrant Blue

Notes

- Specify based on table that enclosure is paired with.
- PET screen inserts are 1/2" (12mm) thick.
- 12" wide wings get one bracket, 18" wide and over wings get two brackets.
- 3/8" gap allows for installation of clamp-on monitors and accessories.
- Unhooks from worksurface for easy access to wire management. Access from user side.
- Height listed above is above surface height. For additional dimensions see product detail pages.

PET Benching HAT L-Wrap Enclosures with Wire Managers

Material	Where Used	Screen Type	Sized For	Mount Type	Handedness
PET	L-Wrap Partial Modesty on WS	Enclosure	L-Wrap for Benching HAT	Under Surface Mount	Left or Right

PET BENCHING HAT L-WRAP ENCLOSURES WITH WIRE MANAGERS

H	W	D	Left Hand	Right Hand	List
			Model Number	Model Number	
3	24	12	Y-5M8K2L031224B	Y-5M8K2R031224B	714
3	30	12	Y-5M8K2L031230B	Y-5M8K2R031230B	733
3	36	12	Y-5M8K2L031236B	Y-5M8K2R031236B	750
3	42	12	Y-5M8K2L031242B	Y-5M8K2R031242B	768
3	48	12	Y-5M8K2L031248B	Y-5M8K2R031248B	788
3	54	12	Y-5M8K2L031254B	Y-5M8K2R031254B	806
3	60	12	Y-5M8K2L031260B	Y-5M8K2R031260B	825
3	66	12	Y-5M8K2L031266B	Y-5M8K2R031266B	843
3	72	12	Y-5M8K2L031272B	Y-5M8K2R031272B	860
3	78	12	Y-5M8K2L031278B	Y-5M8K2R031278B	880
3	24	18	Y-5M8K2L031824B	Y-5M8K2R031824B	733
3	30	18	Y-5M8K2L031830B	Y-5M8K2R031830B	750
3	36	18	Y-5M8K2L031836B	Y-5M8K2R031836B	768
3	42	18	Y-5M8K2L031842B	Y-5M8K2R031842B	788
3	48	18	Y-5M8K2L031848B	Y-5M8K2R031848B	806
3	54	18	Y-5M8K2L031854B	Y-5M8K2R031854B	825
3	60	18	Y-5M8K2L031860B	Y-5M8K2R031860B	843
3	66	18	Y-5M8K2L031866B	Y-5M8K2R031866B	860
3	72	18	Y-5M8K2L031872B	Y-5M8K2R031872B	880

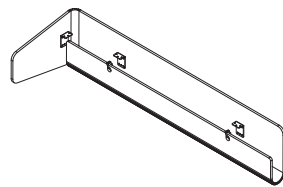

Left Hand

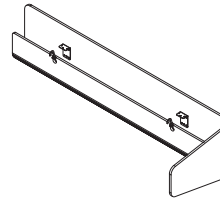

Right Hand

Specify

- Paint Selection
- Color Selection for PET - Lite Grey, Medium Grey, Tan or Vibrant Blue

Notes

- Specify based on table that enclosure is paired with.
- PET screen inserts are 1/2" (12mm) thick.
- 12" wide wings get one bracket, 18" wide and over wings get two brackets.
- 3/8" gap allows for installation of clamp-on monitors and accessories.
- Unhooks from worksurface for easy access to wire management. Access from user side.
- Height listed above is above surface height. For additional dimensions see product detail pages.

PET Benching HAT L-Wrap Enclosures with Wire Managers

Material	Where Used	Screen Type	Sized For	Mount Type	Handedness
PET	L-Wrap Partial Modesty on WS	Enclosure	L-Wrap for Benching HAT	Under Surface Mount	Left or Right

PET BENCHING HAT L-WRAP ENCLOSURES WITH WIRE MANAGERS

H	W	D	Left Hand	Right Hand	List
			Model Number	Model Number	
3	24	24	Y-5M8K2L032424B	Y-5M8K2R032424B	750
3	30	24	Y-5M8K2L032430B	Y-5M8K2R032430B	768
3	36	24	Y-5M8K2L032436B	Y-5M8K2R032436B	788
3	42	24	Y-5M8K2L032442B	Y-5M8K2R032442B	806
3	48	24	Y-5M8K2L032448B	Y-5M8K2R032448B	825
3	54	24	Y-5M8K2L032454B	Y-5M8K2R032454B	843
3	60	24	Y-5M8K2L032460B	Y-5M8K2R032460B	860
3	66	24	Y-5M8K2L032466B	Y-5M8K2R032466B	880
3	24	30	Y-5M8K2L033024B	Y-5M8K2R033024B	768
3	30	30	Y-5M8K2L033030B	Y-5M8K2R033030B	788
3	36	30	Y-5M8K2L033036B	Y-5M8K2R033036B	806
3	42	30	Y-5M8K2L033042B	Y-5M8K2R033042B	825
3	48	30	Y-5M8K2L033048B	Y-5M8K2R033048B	843
3	54	30	Y-5M8K2L033054B	Y-5M8K2R033054B	860
3	60	30	Y-5M8K2L033060B	Y-5M8K2R033060B	880

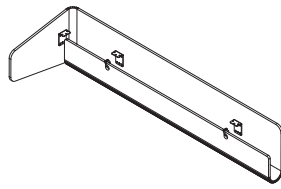

Left Hand

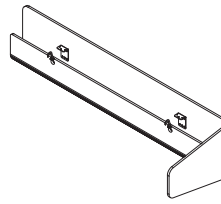

Right Hand

Specify

- Paint Selection
- Color Selection for PET - Lite Grey, Medium Grey, Tan or Vibrant Blue

Notes

- Specify based on table that enclosure is paired with.
- PET screen inserts are 1/2" (12mm) thick.
- 12" wide wings get one bracket, 18" wide and over wings get two brackets.
- 3/8" gap allows for installation of clamp-on monitors and accessories.
- Unhooks from worksurface for easy access to wire management. Access from user side.
- Height listed above is above surface height. For additional dimensions see product detail pages.

PET Benching HAT L-Wrap Enclosures with Wire Managers

Material	Where Used	Screen Type	Sized For	Mount Type	Handedness
PET	L-Wrap Partial Modesty on WS	Enclosure	L-Wrap for Benching HAT	Under Surface Mount	Left or Right

PET BENCHING HAT L-WRAP ENCLOSURES WITH WIRE MANAGERS

H	W	D	Left Hand	Right Hand	List
			Model Number	Model Number	
12	24	12	Y-5M8K2L121224B	Y-5M8K2R121224B	744
12	30	12	Y-5M8K2L121230B	Y-5M8K2R121230B	763
12	36	12	Y-5M8K2L121236B	Y-5M8K2R121236B	782
12	42	12	Y-5M8K2L121242B	Y-5M8K2R121242B	801
12	48	12	Y-5M8K2L121248B	Y-5M8K2R121248B	820
12	54	12	Y-5M8K2L121254B	Y-5M8K2R121254B	839
12	60	12	Y-5M8K2L121260B	Y-5M8K2R121260B	858
12	66	12	Y-5M8K2L121266B	Y-5M8K2R121266B	877
12	72	12	Y-5M8K2L121272B	Y-5M8K2R121272B	897
12	78	12			
12			Y-5M8K2L121278B	Y-5M8K2R121278B	916
12	24	18	Y-5M8K2L121824B	Y-5M8K2R121824B	763
12	30	18	Y-5M8K2L121830B	Y-5M8K2R121830B	782
12	36	18	Y-5M8K2L121836B	Y-5M8K2R121836B	801
12	42	18	Y-5M8K2L121842B	Y-5M8K2R121842B	820
12	48	18	Y-5M8K2L121848B	Y-5M8K2R121848B	839
12	54	18	Y-5M8K2L121854B	Y-5M8K2R121854B	858
12	60	18	Y-5M8K2L121860B	Y-5M8K2R121860B	877
12	66	18	Y-5M8K2L121866B	Y-5M8K2R121866B	897
12	72	18	Y-5M8K2L121872B	Y-5M8K2R121872B	916

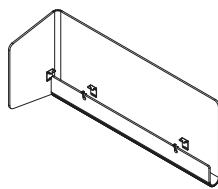

Left Hand

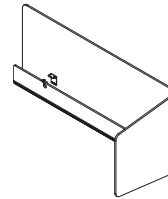

Right Hand

Specify

- Paint Selection
- Color Selection for PET - Lite Grey, Medium Grey, Tan or Vibrant Blue

Notes

- Specify based on table that enclosure is paired with.
- PET screen inserts are 1/2" (12mm) thick.
- 12" wide wings get one bracket, 18" wide and over wings get two brackets.
- 3/8" gap allows for installation of clamp-on monitors and accessories.
- Unhooks from worksurface for easy access to wire management. Access from user side.
- Height listed above is above surface height. For additional dimensions see product detail pages.

PET Benching HAT L-Wrap Enclosures with Wire Managers

Material	Where Used	Screen Type	Sized For	Mount Type	Handedness
PET	L-Wrap Partial Modesty on WS	Enclosure	L-Wrap for Benching HAT	Under Surface Mount	Left or Right

PET BENCHING HAT L-WRAP ENCLOSURES WITH WIRE MANAGERS

H	W	D	Left Hand	Right Hand	List
			Model Number	Model Number	
12	24	24	Y-5M8K2L122424B	Y-5M8K2R122424B	782
12	30	24	Y-5M8K2L122430B	Y-5M8K2R122430B	801
12	36	24	Y-5M8K2L122436B	Y-5M8K2R122436B	820
12	42	24	Y-5M8K2L122442B	Y-5M8K2R122442B	839
12	48	24	Y-5M8K2L122448B	Y-5M8K2R122448B	858
12	54	24	Y-5M8K2L122454B	Y-5M8K2R122454B	877
12	60	24	Y-5M8K2L122460B	Y-5M8K2R122460B	897
12	66	24	Y-5M8K2L122466B	Y-5M8K2R122466B	916
12	24	30	Y-5M8K2L123024B	Y-5M8K2R123024B	801
12	30	30	Y-5M8K2L123030B	Y-5M8K2R123030B	820
12	36	30	Y-5M8K2L123036B	Y-5M8K2R123036B	839
12	42	30	Y-5M8K2L123042B	Y-5M8K2R123042B	858
12	48	30	Y-5M8K2L123048B	Y-5M8K2R123048B	877
12	54	30	Y-5M8K2L123054B	Y-5M8K2R123054B	897
12	60	30	Y-5M8K2L123060B	Y-5M8K2R123060B	916

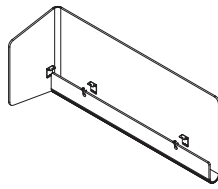

Left Hand

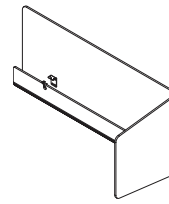

Right Hand

Specify

- Paint Selection
- Color Selection for PET - Lite Grey, Medium Grey, Tan or Vibrant Blue

Notes

- Specify based on table that enclosure is paired with.
- PET screen inserts are 1/2" (12mm) thick.
- 12" wide wings get one bracket, 18" wide and over wings get two brackets.
- 3/8" gap allows for installation of clamp-on monitors and accessories.
- Unhooks from worksurface for easy access to wire management. Access from user side.
- Height listed above is above surface height. For additional dimensions see product detail pages.

PET Benching HAT L-Wrap Enclosures with Wire Managers

Material	Where Used	Screen Type	Sized For	Mount Type	Handedness
PET	L-Wrap Partial Modesty on WS	Enclosure	L-Wrap for Benching HAT	Under Surface Mount	Left or Right

PET BENCHING HAT L-WRAP ENCLOSURES WITH WIRE MANAGERS

H	W	D	Left Hand	Right Hand	List
			Model Number	Model Number	
16	24	12	Y-5M8K2L161224B	Y-5M8K2R161224B	765
16	30	12	Y-5M8K2L161230B	Y-5M8K2R161230B	788
16	36	12	Y-5M8K2L161236B	Y-5M8K2R161236B	809
16	42	12	Y-5M8K2L161242B	Y-5M8K2R161242B	833
16	48	12	Y-5M8K2L161248B	Y-5M8K2R161248B	855
16	54	12	Y-5M8K2L161254B	Y-5M8K2R161254B	877
16	60	12	Y-5M8K2L161260B	Y-5M8K2R161260B	900
16	66	12	Y-5M8K2L161266B	Y-5M8K2R161266B	924
16	72	12	Y-5M8K2L161272B	Y-5M8K2R161272B	948
16	78	12	Y-5M8K2L161278B	Y-5M8K2R161278B	968
16	24	18	Y-5M8K2L161824B	Y-5M8K2R161824B	788
16	30	18	Y-5M8K2L161830B	Y-5M8K2R161830B	809
16	36	18	Y-5M8K2L161836B	Y-5M8K2R161836B	833
16	42	18	Y-5M8K2L161842B	Y-5M8K2R161842B	855
16	48	18	Y-5M8K2L161848B	Y-5M8K2R161848B	877
16	54	18	Y-5M8K2L161854B	Y-5M8K2R161854B	900
16	60	18	Y-5M8K2L161860B	Y-5M8K2R161860B	924
16	66	18	Y-5M8K2L161866B	Y-5M8K2R161866B	948
16	72	18	Y-5M8K2L161872B	Y-5M8K2R161872B	968

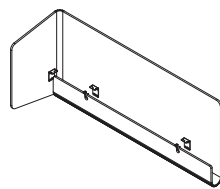

Left Hand

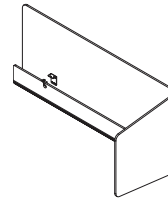

Right Hand

Specify

- Paint Selection
- Color Selection for PET - Lite Grey, Medium Grey, Tan or Vibrant Blue

Notes

- Specify based on table that enclosure is paired with.
- PET screen inserts are 1/2" (12mm) thick.
- 12" wide wings get one bracket, 18" wide and over wings get two brackets.
- 3/8" gap allows for installation of clamp-on monitors and accessories.
- Unhooks from worksurface for easy access to wire management. Access from user side.
- Height listed above is above surface height. For additional dimensions see product detail pages.

PET Benching HAT L-Wrap Enclosures with Wire Managers

Material	Where Used	Screen Type	Sized For	Mount Type	Handedness
PET	L-Wrap Partial Modesty on WS	Enclosure	L-Wrap for Benching HAT	Under Surface Mount	Left or Right

PET BENCHING HAT L-WRAP ENCLOSURES WITH WIRE MANAGERS

H	W	D	Left Hand	Right Hand	List
			Model Number	Model Number	
16	24	24	Y-5M8K2L162424B	Y-5M8K2R162424B	809
16	30	24	Y-5M8K2L162430B	Y-5M8K2R162430B	833
16	36	24	Y-5M8K2L162436B	Y-5M8K2R162436B	855
16	42	24	Y-5M8K2L162442B	Y-5M8K2R162442B	877
16	48	24	Y-5M8K2L162448B	Y-5M8K2R162448B	900
16	54	24	Y-5M8K2L162454B	Y-5M8K2R162454B	924
16	60	24	Y-5M8K2L162460B	Y-5M8K2R162460B	948
16	66	24	Y-5M8K2L162466B	Y-5M8K2R162466B	968
16	24	30	Y-5M8K2L163024B	Y-5M8K2R163024B	833
16	30	30	Y-5M8K2L163030B	Y-5M8K2R163030B	855
16	36	30	Y-5M8K2L163036B	Y-5M8K2R163036B	877
16	42	30	Y-5M8K2L163042B	Y-5M8K2R163042B	900
16	48	30	Y-5M8K2L163048B	Y-5M8K2R163048B	924
16	54	30	Y-5M8K2L163054B	Y-5M8K2R163054B	948
16	60	30	Y-5M8K2L163060B	Y-5M8K2R163060B	968

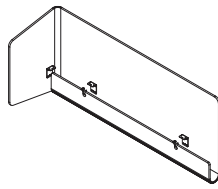

Left Hand

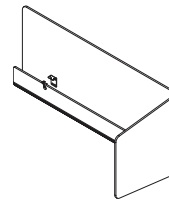

Right Hand

Specify

- Paint Selection
- Color Selection for PET - Lite Grey, Medium Grey, Tan or Vibrant Blue

Notes

- Specify based on table that enclosure is paired with.
- PET screen inserts are 1/2" (12mm) thick.
- 12" wide wings get one bracket, 18" wide and over wings get two brackets.
- 3/8" gap allows for installation of clamp-on monitors and accessories.
- Unhooks from worksurface for easy access to wire management. Access from user side.
- Height listed above is above surface height. For additional dimensions see product detail pages.

PET Benching HAT L-Wrap Enclosures with Wire Managers

Material	Where Used	Screen Type	Sized For	Mount Type	Handedness
PET	L-Wrap Partial Modesty on WS	Enclosure	L-Wrap for Benching HAT	Under Surface Mount	Left or Right

PET BENCHING HAT L-WRAP ENCLOSURES WITH WIRE MANAGERS

H	W	D	Left Hand	Right Hand	List
			Model Number	Model Number	
20	24	12	Y-5M8K2L201224B	Y-5M8K2R201224B	795
20	30	12	Y-5M8K2L201230B	Y-5M8K2R201230B	819
20	36	12	Y-5M8K2L201236B	Y-5M8K2R201236B	843
20	42	12	Y-5M8K2L201242B	Y-5M8K2R201242B	866
20	48	12	Y-5M8K2L201248B	Y-5M8K2R201248B	888
20	54	12	Y-5M8K2L201254B	Y-5M8K2R201254B	912
20	60	12	Y-5M8K2L201260B	Y-5M8K2R201260B	937
20	66	12	Y-5M8K2L201266B	Y-5M8K2R201266B	960
20	72	12	Y-5M8K2L201272B	Y-5M8K2R201272B	985
20	78	12	Y-5M8K2L201278B	Y-5M8K2R201278B	1,007
20	24	18	Y-5M8K2L201824B	Y-5M8K2R201824B	819
20	30	18	Y-5M8K2L201830B	Y-5M8K2R201830B	843
20	36	18	Y-5M8K2L201836B	Y-5M8K2R201836B	866
20	42	18	Y-5M8K2L201842B	Y-5M8K2R201842B	888
20	48	18	Y-5M8K2L201848B	Y-5M8K2R201848B	912
20	54	18	Y-5M8K2L201854B	Y-5M8K2R201854B	937
20	60	18	Y-5M8K2L201860B	Y-5M8K2R201860B	960
20	66	18	Y-5M8K2L201866B	Y-5M8K2R201866B	985
20	72	18	Y-5M8K2L201872B	Y-5M8K2R201872B	1,007

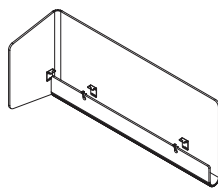

Left Hand

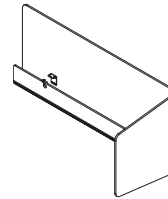

Right Hand

Specify

- Paint Selection
- Color Selection for PET - Lite Grey, Medium Grey, Tan or Vibrant Blue

Notes

- Specify based on table that enclosure is paired with.
- PET screen inserts are 1/2" (12mm) thick.
- 12" wide wings get one bracket, 18" wide and over wings get two brackets.
- 3/8" gap allows for installation of clamp-on monitors and accessories.
- Unhooks from worksurface for easy access to wire management. Access from user side.
- Height listed above is above surface height. For additional dimensions see product detail pages.

PET Benching HAT L-Wrap Enclosures with Wire Managers

Material	Where Used	Screen Type	Sized For	Mount Type	Handedness
PET	L-Wrap Partial Modesty on WS	Enclosure	L-Wrap for Benching HAT	Under Surface Mount	Left or Right

PET BENCHING HAT L-WRAP ENCLOSURES WITH WIRE MANAGERS

H	W	D	Left Hand	Right Hand	List
			Model Number	Model Number	
20	24	24	Y-5M8K2L202424B	Y-5M8K2R202424B	843
20	30	24	Y-5M8K2L202430B	Y-5M8K2R202430B	866
20	36	24	Y-5M8K2L202436B	Y-5M8K2R202436B	888
20	42	24	Y-5M8K2L202442B	Y-5M8K2R202442B	912
20	48	24	Y-5M8K2L202448B	Y-5M8K2R202448B	937
20	54	24	Y-5M8K2L202454B	Y-5M8K2R202454B	960
20	60	24	Y-5M8K2L202460B	Y-5M8K2R202460B	985
20	66	24	Y-5M8K2L202466B	Y-5M8K2R202466B	1,007
20	24	30	Y-5M8K2L203024B	Y-5M8K2R203024B	866
20	30	30	Y-5M8K2L203030B	Y-5M8K2R203030B	888
20	36	30	Y-5M8K2L203036B	Y-5M8K2R203036B	912
20	42	30	Y-5M8K2L203042B	Y-5M8K2R203042B	937
20	48	30	Y-5M8K2L203048B	Y-5M8K2R203048B	960
20	54	30	Y-5M8K2L203054B	Y-5M8K2R203054B	985
20	60	30	Y-5M8K2L203060B	Y-5M8K2R203060B	1,007

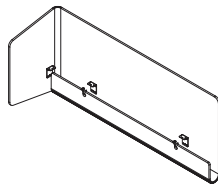

Left Hand

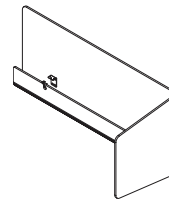

Right Hand

Specify

- Paint Selection
- Color Selection for PET - Lite Grey, Medium Grey, Tan or Vibrant Blue

Notes

- Specify based on table that enclosure is paired with.
- PET screen inserts are 1/2" (12mm) thick.
- 12" wide wings get one bracket, 18" wide and over wings get two brackets.
- 3/8" gap allows for installation of clamp-on monitors and accessories.
- Unhooks from worksurface for easy access to wire management. Access from user side.
- Height listed above is above surface height. For additional dimensions see product detail pages.

PET Benching HAT L-Wrap Enclosures with Wire Managers

Material	Where Used	Screen Type	Sized For	Mount Type	Handedness
PET	L-Wrap Partial Modesty on WS	Enclosure	L-Wrap for Benching HAT	Under Surface Mount	Left or Right

PET BENCHING HAT L-WRAP ENCLOSURES WITH WIRE MANAGERS

H	W	D	Left Hand	Right Hand	List
			Model Number	Model Number	
24	24	12	Y-5M8K2L241224B	Y-5M8K2R241224B	877
24	30	12	Y-5M8K2L241230B	Y-5M8K2R241230B	918
24	36	12	Y-5M8K2L241236B	Y-5M8K2R241236B	961
24	42	12	Y-5M8K2L241242B	Y-5M8K2R241242B	1,003
24	48	12	Y-5M8K2L241248B	Y-5M8K2R241248B	1,046
24	54	12	Y-5M8K2L241254B	Y-5M8K2R241254B	1,087
24	60	12	Y-5M8K2L241260B	Y-5M8K2R241260B	1,128
24	66	12	Y-5M8K2L241266B	Y-5M8K2R241266B	1,169
24	72	12	Y-5M8K2L241272B	Y-5M8K2R241272B	1,210
24	78	12	Y-5M8K2L241278B	Y-5M8K2R241278B	1,253
24	24	18	Y-5M8K2L241824B	Y-5M8K2R241824B	918
24	30	18	Y-5M8K2L241830B	Y-5M8K2R241830B	961
24	36	18	Y-5M8K2L241836B	Y-5M8K2R241836B	1,003
24	42	18	Y-5M8K2L241842B	Y-5M8K2R241842B	1,046
24	48	18	Y-5M8K2L241848B	Y-5M8K2R241848B	1,087
24	54	18	Y-5M8K2L241854B	Y-5M8K2R241854B	1,128
24	60	18	Y-5M8K2L241860B	Y-5M8K2R241860B	1,169
24	66	18	Y-5M8K2L241866B	Y-5M8K2R241866B	1,210
24	72	18	Y-5M8K2L241872B	Y-5M8K2R241872B	1,253

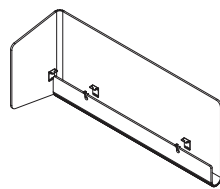

Left Hand

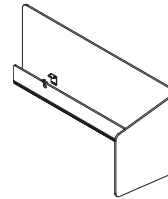

Right Hand

Specify

- Paint Selection
- Color Selection for PET - Lite Grey, Medium Grey, Tan or Vibrant Blue

Notes

- Specify based on table that enclosure is paired with.
- PET screen inserts are 1/2" (12mm) thick.
- 12" wide wings get one bracket, 18" wide and over wings get two brackets.
- 3/8" gap allows for installation of clamp-on monitors and accessories.
- Unhooks from worksurface for easy access to wire management. Access from user side.
- Height listed above is above surface height. For additional dimensions see product detail pages.

PET Benching HAT L-Wrap Enclosures with Wire Managers

Material	Where Used	Screen Type	Sized For	Mount Type	Handedness
PET	L-Wrap Partial Modesty on WS	Enclosure	L-Wrap for Benching HAT	Under Surface Mount	Left or Right

PET BENCHING HAT L-WRAP ENCLOSURES WITH WIRE MANAGERS

H	W	D	Left Hand	Right Hand	List
			Model Number	Model Number	
24	24	24	Y-5M8K2L242424B	Y-5M8K2R242424B	961
24	30	24	Y-5M8K2L242430B	Y-5M8K2R242430B	1,003
24	36	24	Y-5M8K2L242436B	Y-5M8K2R242436B	1,046
24	42	24	Y-5M8K2L242442B	Y-5M8K2R242442B	1,087
24	48	24	Y-5M8K2L242448B	Y-5M8K2R242448B	1,128
24	54	24	Y-5M8K2L242454B	Y-5M8K2R242454B	1,169
24	60	24	Y-5M8K2L242460B	Y-5M8K2R242460B	1,210
24	66	24	Y-5M8K2L242466B	Y-5M8K2R242466B	1,253
24	24	30	Y-5M8K2L243024B	Y-5M8K2R243024B	1,003
24	30	30	Y-5M8K2L243030B	Y-5M8K2R243030B	1,046
24	36	30	Y-5M8K2L243036B	Y-5M8K2R243036B	1,087
24	42	30	Y-5M8K2L243042B	Y-5M8K2R243042B	1,128
24	48	30	Y-5M8K2L243048B	Y-5M8K2R243048B	1,169
24	54	30	Y-5M8K2L243054B	Y-5M8K2R243054B	1,210
24	60	30	Y-5M8K2L243060B	Y-5M8K2R243060B	1,253

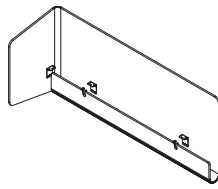

Left Hand

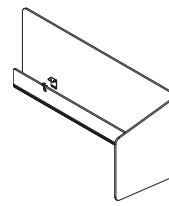

Right Hand

Specify

- Paint Selection
- Color Selection for PET - Lite Grey, Medium Grey, Tan or Vibrant Blue

Notes

- Specify based on table that enclosure is paired with.
- PET screen inserts are 1/2" (12mm) thick.
- 12" wide wings get one bracket, 18" wide and over wings get two brackets.
- 3/8" gap allows for installation of clamp-on monitors and accessories.
- Unhooks from worksurface for easy access to wire management. Access from user side.
- Height listed above is above surface height. For additional dimensions see product detail pages.

PET Benching HAT L-Wrap Enclosures with Wire Managers

Material	Where Used	Screen Type	Sized For	Mount Type	Handedness
PET	L-Wrap Partial Modesty on WS	Enclosure	L-Wrap for Benching HAT	Under Surface Mount	Left or Right

PET BENCHING HAT L-WRAP ENCLOSURES WITH WIRE MANAGERS

H	W	D	Left Hand	Right Hand	List
			Model Number	Model Number	
28	24	12	Y-5M8K2L281224B	Y-5M8K2R281224B	909
28	30	12	Y-5M8K2L281230B	Y-5M8K2R281230B	954
28	36	12	Y-5M8K2L281236B	Y-5M8K2R281236B	1,001
28	42	12	Y-5M8K2L281242B	Y-5M8K2R281242B	1,047
28	48	12	Y-5M8K2L281248B	Y-5M8K2R281248B	1,093
28	54	12	Y-5M8K2L281254B	Y-5M8K2R281254B	1,140
28	60	12	Y-5M8K2L281260B	Y-5M8K2R281260B	1,184
28	66	12	Y-5M8K2L281266B	Y-5M8K2R281266B	1,234
28	72	12	Y-5M8K2L281272B	Y-5M8K2R281272B	1,280
28	78	12	Y-5M8K2L281278B	Y-5M8K2R281278B	1,327
28	24	18	Y-5M8K2L281824B	Y-5M8K2R281824B	954
28	30	18	Y-5M8K2L281830B	Y-5M8K2R281830B	1,001
28	36	18	Y-5M8K2L281836B	Y-5M8K2R281836B	1,047
28	42	18	Y-5M8K2L281842B	Y-5M8K2R281842B	1,093
28	48	18	Y-5M8K2L281848B	Y-5M8K2R281848B	1,140
28	54	18	Y-5M8K2L281854B	Y-5M8K2R281854B	1,184
28	60	18	Y-5M8K2L281860B	Y-5M8K2R281860B	1,234
28	66	18	Y-5M8K2L281866B	Y-5M8K2R281866B	1,280
28	72	18	Y-5M8K2L281872B	Y-5M8K2R281872B	1,327

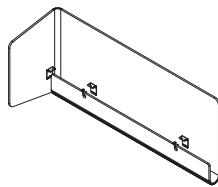

Left Hand

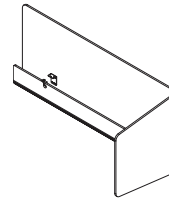

Right Hand

Specify

- Paint Selection
- Color Selection for PET - Lite Grey, Medium Grey, Tan or Vibrant Blue

Notes

- Specify based on table that enclosure is paired with.
- PET screen inserts are 1/2" (12mm) thick.
- 12" wide wings get one bracket, 18" wide and over wings get two brackets.
- 3/8" gap allows for installation of clamp-on monitors and accessories.
- Unhooks from worksurface for easy access to wire management. Access from user side.
- Height listed above is above surface height. For additional dimensions see product detail pages.

PET Benching HAT L-Wrap Enclosures with Wire Managers

Material	Where Used	Screen Type	Sized For	Mount Type	Handedness
PET	L-Wrap Partial Modesty on WS	Enclosure	L-Wrap for Benching HAT	Under Surface Mount	Left or Right

PET BENCHING HAT L-WRAP ENCLOSURES WITH WIRE MANAGERS

H	W	D	Left Hand	Right Hand	List
			Model Number	Model Number	
28	24	24	Y-5M8K2L282424B	Y-5M8K2R282424B	1,001
28	30	24	Y-5M8K2L282430B	Y-5M8K2R282430B	1,047
28	36	24	Y-5M8K2L282436B	Y-5M8K2R282436B	1,093
28	42	24	Y-5M8K2L282442B	Y-5M8K2R282442B	1,140
28	48	24	Y-5M8K2L282448B	Y-5M8K2R282448B	1,184
28	54	24	Y-5M8K2L282454B	Y-5M8K2R282454B	1,234
28	60	24	Y-5M8K2L282460B	Y-5M8K2R282460B	1,280
28	66	24	Y-5M8K2L282466B	Y-5M8K2R282466B	1,327
28	24	30	Y-5M8K2L283024B	Y-5M8K2R283024B	1,047
28	30	30	Y-5M8K2L283030B	Y-5M8K2R283030B	1,093
28	36	30	Y-5M8K2L283036B	Y-5M8K2R283036B	1,140
28	42	30	Y-5M8K2L283042B	Y-5M8K2R283042B	1,184
28	48	30	Y-5M8K2L283048B	Y-5M8K2R283048B	1,234
28	54	30	Y-5M8K2L283054B	Y-5M8K2R283054B	1,280
28	60	30	Y-5M8K2L283060B	Y-5M8K2R283060B	1,327

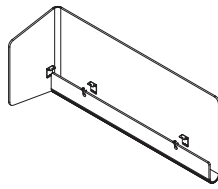

Left Hand

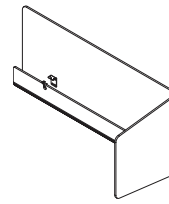

Right Hand

Specify

- Paint Selection
- Color Selection for PET - Lite Grey, Medium Grey, Tan or Vibrant Blue

Notes

- Specify based on table that enclosure is paired with.
- PET screen inserts are 1/2" (12mm) thick.
- 12" wide wings get one bracket, 18" wide and over wings get two brackets.
- 3/8" gap allows for installation of clamp-on monitors and accessories.
- Unhooks from worksurface for easy access to wire management. Access from user side.
- Height listed above is above surface height. For additional dimensions see product detail pages.

U-Wrap Enclosures with Wire Managers

PET Nominal = Actual Size U-Wrap Enclosures with Wire Managers

Material	Where Used	Screen Type	Sized For	Mount Type
PET	U-Wrap Partial Modesty on WS	Enclosure w/ Wire Manager	Nominal = Actual Size	Under Surface Mount

PET NOMINAL = ACTUAL SIZE U-WRAP ENCLOSURES WITH WIRE MANAGERS

H	W	D	PET Pieces	Model Number	List
3	42	12	1	Y-5Q8Q2U031242B	768
3	48	12	1	Y-5Q8Q2U031248B	788
3	54	12	1	Y-5Q8Q2U031254B	806
3	60	12	1	Y-5Q8Q2U031260B	825
3	66	12	1	Y-5Q8Q2U031266B	843
3	72	12	2	Y-5Q8Q2U031272B	860
3	78	12	2	Y-5Q8Q2U031278B	880
3	84	12	2	Y-5Q8Q2U031284B	936
3	42	18	1	Y-5Q8Q2U031842B	788
3	48	18	1	Y-5Q8Q2U031848B	806
3	54	18	1	Y-5Q8Q2U031854B	825
3	60	18	2	Y-5Q8Q2U031860B	843
3	66	18	2	Y-5Q8Q2U031866B	860
3	72	18	2	Y-5Q8Q2U031872B	880
3	78	18	2	Y-5Q8Q2U031878B	954
3	84	18	2	Y-5Q8Q2U031884B	972

PET NOMINAL = ACTUAL SIZE U-WRAP ENCLOSURES WITH WIRE MANAGERS

H	W	D	PET Pieces	Model Number	List
3	42	24	1	Y-5Q8Q2U032442B	806
3	48	24	2	Y-5Q8Q2U032448B	825
3	54	24	2	Y-5Q8Q2U032454B	843
3	60	24	2	Y-5Q8Q2U032460B	860
3	66	24	2	Y-5Q8Q2U032466B	880
3	72	24	2	Y-5Q8Q2U032472B	972
3	78	24	2	Y-5Q8Q2U032478B	991
3	84	24	2	Y-5Q8Q2U032484B	1,010
3	42	30	2	Y-5Q8Q2U033042B	825
3	48	30	2	Y-5Q8Q2U033048B	843
3	54	30	2	Y-5Q8Q2U033054B	860
3	60	30	2	Y-5Q8Q2U033060B	880
3	66	30	2	Y-5Q8Q2U033066B	991
3	72	30	2	Y-5Q8Q2U033072B	1,010
3	78	30	2	Y-5Q8Q2U033078B	1,029
3	84	30	2	Y-5Q8Q2U033084B	1,047

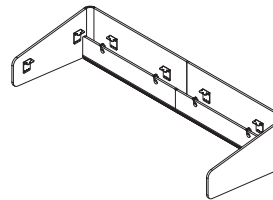
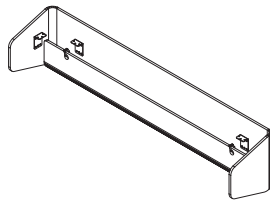

Specify

- Paint Selection
- Color Selection for PET - Lite Grey, Medium Grey, Tan or Vibrant Blue

Notes

- PET U-Wrap Screens are designed to mount to AIS worksurfaces. Specify based on nominal size for the desired system. Order screens that correspond to worksurface width and depth.
- PET screen inserts are 1/2" (12mm) thick.
- U-Wrap screens typically constructed with 2 pieces of PET, some smaller sizes are constructed from 1 piece when possible. See PET pieces column above for reference. See PET pieces column above for reference.
- 3/8" gap allows for installation of clamp-on monitors and accessories.
- Unhooks from worksurface for easy access to wire management. Access from user side.
- Height listed above is above surface height. For additional dimensions see product detail pages.

PET Nominal = Actual Size U-Wrap Enclosures with Wire Managers

Material	Where Used	Screen Type	Sized For	Mount Type
PET	U-Wrap Partial Modesty on WS	Enclosure w/ Wire Manager	Nominal = Actual Size	Under Surface Mount

PET NOMINAL = ACTUAL SIZE U-WRAP ENCLOSURES WITH WIRE MANAGERS

H	W	D	PET Pieces	Model Number	List
12	42	12	1	Y-5Q8Q2U121242B	801
12	48	12	1	Y-5Q8Q2U121248B	820
12	54	12	1	Y-5Q8Q2U121254B	839
12	60	12	1	Y-5Q8Q2U121260B	858
12	66	12	1	Y-5Q8Q2U121266B	877
12	72	12	2	Y-5Q8Q2U121272B	897
12	78	12	2	Y-5Q8Q2U121278B	916
12	84	12	2	Y-5Q8Q2U121284B	976
12	42	18	1	Y-5Q8Q2U121842B	820
12	48	18	1	Y-5Q8Q2U121848B	839
12	54	18	1	Y-5Q8Q2U121854B	858
12	60	18	2	Y-5Q8Q2U121860B	877
12	66	18	2	Y-5Q8Q2U121866B	897
12	72	18	2	Y-5Q8Q2U121872B	916
12	78	18	2	Y-5Q8Q2U121878B	994
12	84	18	2	Y-5Q8Q2U121884B	1,015

PET NOMINAL = ACTUAL SIZE U-WRAP ENCLOSURES WITH WIRE MANAGERS

H	W	D	PET Pieces	Model Number	List
12	42	24	1	Y-5Q8Q2U122442B	839
12	48	24	2	Y-5Q8Q2U122448B	858
12	54	24	2	Y-5Q8Q2U122454B	877
12	60	24	2	Y-5Q8Q2U122460B	897
12	66	24	2	Y-5Q8Q2U122466B	916
12	72	24	2	Y-5Q8Q2U122472B	1,015
12	78	24	2	Y-5Q8Q2U122478B	1,032
12	84	24	2	Y-5Q8Q2U122484B	1,051
12	42	30	2	Y-5Q8Q2U123042B	858
12	48	30	2	Y-5Q8Q2U123048B	877
12	54	30	2	Y-5Q8Q2U123054B	897
12	60	30	2	Y-5Q8Q2U123060B	916
12	66	30	2	Y-5Q8Q2U123066B	1,032
12	72	30	2	Y-5Q8Q2U123072B	1,051
12	78	30	2	Y-5Q8Q2U123078B	1,071
12	84	30	2	Y-5Q8Q2U123084B	1,090

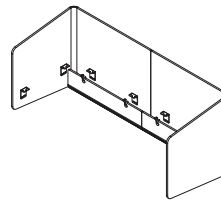
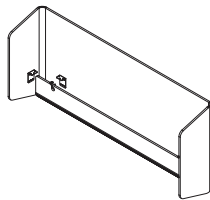

Specify

- Paint Selection
- Color Selection for PET - Lite Grey, Medium Grey, Tan or Vibrant Blue

Notes

- PET U-Wrap Screens are designed to mount to AIS worksurfaces. Specify based on nominal size for the desired system. Order screens that correspond to worksurface width and depth.
- PET screen inserts are 1/2" (12mm) thick.
- U-Wrap screens typically constructed with 2 pieces of PET, some smaller sizes are constructed from 1 piece when possible. See PET pieces column above for reference. See PET pieces column above for reference.
- 3/8" gap allows for installation of clamp-on monitors and accessories.
- Unhooks from worksurface for easy access to wire management. Access from user side.
- Height listed above is above surface height. For additional dimensions see product detail pages.

PET Nominal = Actual Size U-Wrap Enclosures with Wire Managers

Material	Where Used	Screen Type	Sized For	Mount Type
PET	U-Wrap Partial Modesty on WS	Enclosure w/ Wire Manager	Nominal = Actual Size	Under Surface Mount

PET NOMINAL = ACTUAL SIZE U-WRAP ENCLOSURES WITH WIRE MANAGERS

H	W	D	PET Pieces	Model Number	List
16	42	12	1	Y-5Q8Q2U161242B	833
16	48	12	1	Y-5Q8Q2U161248B	855
16	54	12	1	Y-5Q8Q2U161254B	877
16	60	12	1	Y-5Q8Q2U161260B	900
16	66	12	1	Y-5Q8Q2U161266B	924
16	72	12	2	Y-5Q8Q2U161272B	948
16	78	12	2	Y-5Q8Q2U161278B	968
16	84	12	2	Y-5Q8Q2U161284B	1,037
16	42	18	1	Y-5Q8Q2U161842B	855
16	48	18	1	Y-5Q8Q2U161848B	877
16	54	18	1	Y-5Q8Q2U161854B	900
16	60	18	2	Y-5Q8Q2U161860B	924
16	66	18	2	Y-5Q8Q2U161866B	948
16	72	18	2	Y-5Q8Q2U161872B	968
16	78	18	2	Y-5Q8Q2U161878B	1,060
16	84	18	2	Y-5Q8Q2U161884B	1,085

PET NOMINAL = ACTUAL SIZE U-WRAP ENCLOSURES WITH WIRE MANAGERS

H	W	D	PET Pieces	Model Number	List
16	42	24	1	Y-5Q8Q2U162442B	877
16	48	24	2	Y-5Q8Q2U162448B	900
16	54	24	2	Y-5Q8Q2U162454B	924
16	60	24	2	Y-5Q8Q2U162460B	948
16	66	24	2	Y-5Q8Q2U162466B	968
16	72	24	2	Y-5Q8Q2U162472B	1,085
16	78	24	2	Y-5Q8Q2U162478B	1,107
16	84	24	2	Y-5Q8Q2U162484B	1,129
16	42	30	2	Y-5Q8Q2U163042B	900
16	48	30	2	Y-5Q8Q2U163048B	924
16	54	30	2	Y-5Q8Q2U163054B	948
16	60	30	2	Y-5Q8Q2U163060B	968
16	66	30	2	Y-5Q8Q2U163066B	1,107
16	72	30	2	Y-5Q8Q2U163072B	1,129
16	78	30	2	Y-5Q8Q2U163078B	1,152
16	84	30	2	Y-5Q8Q2U163084B	1,173

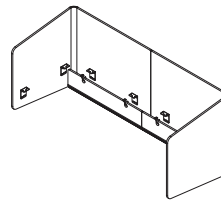
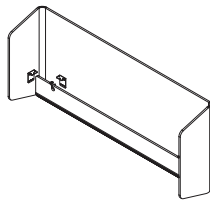

Specify

- Paint Selection
- Color Selection for PET - Lite Grey, Medium Grey, Tan or Vibrant Blue

Notes

- PET U-Wrap Screens are designed to mount to AIS worksurfaces. Specify based on nominal size for the desired system. Order screens that correspond to worksurface width and depth.
- PET screen inserts are 1/2" (12mm) thick.
- U-Wrap screens typically constructed with 2 pieces of PET, some smaller sizes are constructed from 1 piece when possible. See PET pieces column above for reference. See PET pieces column above for reference.
- 3/8" gap allows for installation of clamp-on monitors and accessories.
- Unhooks from worksurface for easy access to wire management. Access from user side.
- Height listed above is above surface height. For additional dimensions see product detail pages.

PET Nominal = Actual Size U-Wrap Enclosures with Wire Managers

Material	Where Used	Screen Type	Sized For	Mount Type
PET	U-Wrap Partial Modesty on WS	Enclosure w/ Wire Manager	Nominal = Actual Size	Under Surface Mount

PET NOMINAL = ACTUAL SIZE U-WRAP ENCLOSURES WITH WIRE MANAGERS

H	W	D	PET Pieces	Model Number	List
20	42	12	1	Y-5Q8Q2U201242B	1,032
20	48	12	1	Y-5Q8Q2U201248B	1,070
20	54	12	1	Y-5Q8Q2U201254B	1,107
20	60	12	1	Y-5Q8Q2U201260B	1,141
20	66	12	1	Y-5Q8Q2U201266B	1,179
20	72	12	2	Y-5Q8Q2U201272B	1,217
20	78	12	2	Y-5Q8Q2U201278B	1,253
20	84	12	2	Y-5Q8Q2U201284B	1,289
20	42	18	1	Y-5Q8Q2U201842B	1,107
20	48	18	1	Y-5Q8Q2U201848B	1,141
20	54	18	1	Y-5Q8Q2U201854B	1,179
20	60	18	2	Y-5Q8Q2U201860B	1,217
20	66	18	2	Y-5Q8Q2U201866B	1,253
20	72	18	2	Y-5Q8Q2U201872B	1,289
20	78	18	2	Y-5Q8Q2U201878B	1,327
20	84	18	2	Y-5Q8Q2U201884B	1,363

PET NOMINAL = ACTUAL SIZE U-WRAP ENCLOSURES WITH WIRE MANAGERS

H	W	D	PET Pieces	Model Number	List
20	42	24	1	Y-5Q8Q2U202442B	1,179
20	48	24	2	Y-5Q8Q2U202448B	1,217
20	54	24	2	Y-5Q8Q2U202454B	1,253
20	60	24	2	Y-5Q8Q2U202460B	1,289
20	66	24	2	Y-5Q8Q2U202466B	1,327
20	72	24	2	Y-5Q8Q2U202472B	1,363
20	78	24	2	Y-5Q8Q2U202478B	1,402
20	84	24	2	Y-5Q8Q2U202484B	1,438
20	42	30	2	Y-5Q8Q2U203042B	1,253
20	48	30	2	Y-5Q8Q2U203048B	1,289
20	54	30	2	Y-5Q8Q2U203054B	1,327
20	60	30	2	Y-5Q8Q2U203060B	1,363
20	66	30	2	Y-5Q8Q2U203066B	1,402
20	72	30	2	Y-5Q8Q2U203072B	1,438
20	78	30	2	Y-5Q8Q2U203078B	1,475
20	84	30	2	Y-5Q8Q2U203084B	1,511

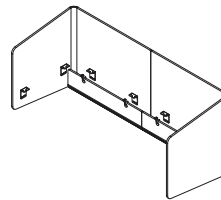
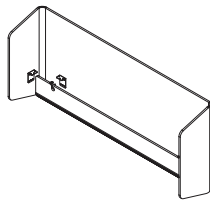

Specify

- Paint Selection
- Color Selection for PET - Lite Grey, Medium Grey, Tan or Vibrant Blue

Notes

- PET U-Wrap Screens are designed to mount to AIS worksurfaces. Specify based on nominal size for the desired system. Order screens that correspond to worksurface width and depth.
- PET screen inserts are 1/2" (12mm) thick.
- U-Wrap screens typically constructed with 2 pieces of PET, some smaller sizes are constructed from 1 piece when possible. See PET pieces column above for reference. See PET pieces column above for reference.
- 3/8" gap allows for installation of clamp-on monitors and accessories.
- Unhooks from worksurface for easy access to wire management. Access from user side.
- Height listed above is above surface height. For additional dimensions see product detail pages.

PET Nominal = Actual Size U-Wrap Enclosures with Wire Managers

Material	Where Used	Screen Type	Sized For	Mount Type
PET	U-Wrap Partial Modesty on WS	Enclosure w/ Wire Manager	Nominal = Actual Size	Under Surface Mount

PET NOMINAL = ACTUAL SIZE U-WRAP ENCLOSURES WITH WIRE MANAGERS

H	W	D	PET Pieces	Model Number	List
24	42	12	1	Y-5Q8Q2U241242B	1,003
24	48	12	1	Y-5Q8Q2U241248B	1,046
24	54	12	1	Y-5Q8Q2U241254B	1,087
24	60	12	1	Y-5Q8Q2U241260B	1,128
24	66	12	1	Y-5Q8Q2U241266B	1,169
24	72	12	2	Y-5Q8Q2U241272B	1,210
24	78	12	2	Y-5Q8Q2U241278B	1,253
24	84	12	2	Y-5Q8Q2U241284B	1,379
24	42	18	1	Y-5Q8Q2U241842B	1,046
24	48	18	1	Y-5Q8Q2U241848B	1,087
24	54	18	1	Y-5Q8Q2U241854B	1,128
24	60	18	2	Y-5Q8Q2U241860B	1,169
24	66	18	2	Y-5Q8Q2U241866B	1,210
24	72	18	2	Y-5Q8Q2U241872B	1,253
24	78	18	2	Y-5Q8Q2U241878B	1,420
24	84	18	2	Y-5Q8Q2U241884B	1,461

PET NOMINAL = ACTUAL SIZE U-WRAP ENCLOSURES WITH WIRE MANAGERS

H	W	D	PET Pieces	Model Number	List
24	42	24	1	Y-5Q8Q2U242442B	1,087
24	48	24	2	Y-5Q8Q2U242448B	1,128
24	54	24	2	Y-5Q8Q2U242454B	1,169
24	60	24	2	Y-5Q8Q2U242460B	1,210
24	66	24	2	Y-5Q8Q2U242466B	1,253
24	72	24	2	Y-5Q8Q2U242472B	1,461
24	78	24	2	Y-5Q8Q2U242478B	1,503
24	84	24	2	Y-5Q8Q2U242484B	1,546
24	42	30	2	Y-5Q8Q2U243042B	1,128
24	48	30	2	Y-5Q8Q2U243048B	1,169
24	54	30	2	Y-5Q8Q2U243054B	1,210
24	60	30	2	Y-5Q8Q2U243060B	1,253
24	66	30	2	Y-5Q8Q2U243066B	1,503
24	72	30	2	Y-5Q8Q2U243072B	1,546
24	78	30	2	Y-5Q8Q2U243078B	1,587
24	84	30	2	Y-5Q8Q2U243084B	1,629

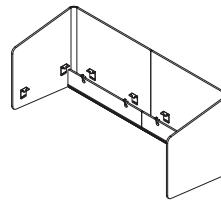
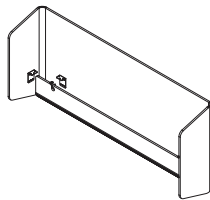

Specify

- Paint Selection
- Color Selection for PET - Lite Grey, Medium Grey, Tan or Vibrant Blue

Notes

- PET U-Wrap Screens are designed to mount to AIS worksurfaces. Specify based on nominal size for the desired system. Order screens that correspond to worksurface width and depth.
- PET screen inserts are 1/2" (12mm) thick.
- U-Wrap screens typically constructed with 2 pieces of PET, some smaller sizes are constructed from 1 piece when possible. See PET pieces column above for reference. See PET pieces column above for reference.
- 3/8" gap allows for installation of clamp-on monitors and accessories.
- Unhooks from worksurface for easy access to wire management. Access from user side.
- Height listed above is above surface height. For additional dimensions see product detail pages.

PET Nominal = Actual Size U-Wrap Enclosures with Wire Managers

Material	Where Used	Screen Type	Sized For	Mount Type
PET	U-Wrap Partial Modesty on WS	Enclosure w/ Wire Manager	Nominal = Actual Size	Under Surface Mount

PET NOMINAL = ACTUAL SIZE U-WRAP ENCLOSURES WITH WIRE MANAGERS

H	W	D	PET Pieces	Model Number	List
28	42	12	1	Y-5Q8Q2U281242B	1,047
28	48	12	1	Y-5Q8Q2U281248B	1,093
28	54	12	1	Y-5Q8Q2U281254B	1,140
28	60	12	1	Y-5Q8Q2U281260B	1,184
28	66	12	1	Y-5Q8Q2U281266B	1,234
28	72	12	2	Y-5Q8Q2U281272B	1,280
28	78	12	2	Y-5Q8Q2U281278B	1,327
28	84	12	2	Y-5Q8Q2U281284B	1,466
28	42	18	1	Y-5Q8Q2U281842B	1,093
28	48	18	1	Y-5Q8Q2U281848B	1,140
28	54	18	1	Y-5Q8Q2U281854B	1,184
28	60	18	2	Y-5Q8Q2U281860B	1,234
28	66	18	2	Y-5Q8Q2U281866B	1,280
28	72	18	2	Y-5Q8Q2U281872B	1,327
28	78	18	2	Y-5Q8Q2U281878B	1,512
28	84	18	2	Y-5Q8Q2U281884B	1,561

PET NOMINAL = ACTUAL SIZE U-WRAP ENCLOSURES WITH WIRE MANAGERS

H	W	D	PET Pieces	Model Number	List
28	42	24	1	Y-5Q8Q2U282442B	1,140
28	48	24	2	Y-5Q8Q2U282448B	1,184
28	54	24	2	Y-5Q8Q2U282454B	1,234
28	60	24	2	Y-5Q8Q2U282460B	1,280
28	66	24	2	Y-5Q8Q2U282466B	1,327
28	72	24	2	Y-5Q8Q2U282472B	1,561
28	78	24	2	Y-5Q8Q2U282478B	1,606
28	84	24	2	Y-5Q8Q2U282484B	1,654
28	42	30	2	Y-5Q8Q2U283042B	1,184
28	48	30	2	Y-5Q8Q2U283048B	1,234
28	54	30	2	Y-5Q8Q2U283054B	1,280
28	60	30	2	Y-5Q8Q2U283060B	1,327
28	66	30	2	Y-5Q8Q2U283066B	1,606
28	72	30	2	Y-5Q8Q2U283072B	1,654
28	78	30	2	Y-5Q8Q2U283078B	1,700
28	84	30	2	Y-5Q8Q2U283084B	1,746

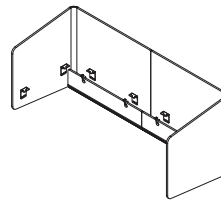
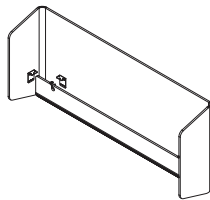

Specify

- Paint Selection
- Color Selection for PET - Lite Grey, Medium Grey, Tan or Vibrant Blue

Notes

- PET U-Wrap Screens are designed to mount to AIS worksurfaces. Specify based on nominal size for the desired system. Order screens that correspond to worksurface width and depth.
- PET screen inserts are 1/2" (12mm) thick.
- U-Wrap screens typically constructed with 2 pieces of PET, some smaller sizes are constructed from 1 piece when possible. See PET pieces column above for reference. See PET pieces column above for reference.
- 3/8" gap allows for installation of clamp-on monitors and accessories.
- Unhooks from worksurface for easy access to wire management. Access from user side.
- Height listed above is above surface height. For additional dimensions see product detail pages.

PET Day-to-Day & Calibrate HAT U-Wrap Enclosures with Wire Managers

Material	Where Used	Screen Type	Sized For	Mount Type
PET	U-Wrap Partial Modesty on WS	Enclosure w/ Wire Manager	Day-to-Day & Calibrate HAT	Under Surface Mount

PET DAY-TO-DAY & CALIBRATE U-WRAP ENCLOSURES WITH WIRE MANAGERS

H	W	D	PET Pieces	Model Number	List
3	42	12	1	Y-5Q8N2U031242B	768
3	48	12	1	Y-5Q8N2U031248B	788
3	54	12	1	Y-5Q8N2U031254B	806
3	60	12	1	Y-5Q8N2U031260B	825
3	66	12	1	Y-5Q8N2U031266B	843
3	72	12	2	Y-5Q8N2U031272B	860
3	78	12	2	Y-5Q8N2U031278B	880
3	84	12	2	Y-5Q8N2U031284B	936
3	42	18	1	Y-5Q8N2U031842B	788
3	48	18	1	Y-5Q8N2U031848B	806
3	54	18	1	Y-5Q8N2U031854B	825
3	60	18	2	Y-5Q8N2U031860B	843
3	66	18	2	Y-5Q8N2U031866B	860
3	72	18	2	Y-5Q8N2U031872B	880
3	78	18	2	Y-5Q8N2U031878B	954
3	84	18	2	Y-5Q8N2U031884B	972

PET DAY-TO-DAY & CALIBRATE U-WRAP ENCLOSURES WITH WIRE MANAGERS

H	W	D	PET Pieces	Model Number	List
3	42	24	1	Y-5Q8N2U032442B	806
3	48	24	2	Y-5Q8N2U032448B	825
3	54	24	2	Y-5Q8N2U032454B	843
3	60	24	2	Y-5Q8N2U032460B	860
3	66	24	2	Y-5Q8N2U032466B	880
3	72	24	2	Y-5Q8N2U032472B	972
3	78	24	2	Y-5Q8N2U032478B	991
3	84	24	2	Y-5Q8N2U032484B	1,010
3	42	30	2	Y-5Q8N2U033042B	825
3	48	30	2	Y-5Q8N2U033048B	843
3	54	30	2	Y-5Q8N2U033054B	860
3	60	30	2	Y-5Q8N2U033060B	880
3	66	30	2	Y-5Q8N2U033066B	991
3	72	30	2	Y-5Q8N2U033072B	1,010
3	78	30	2	Y-5Q8N2U033078B	1,029
3	84	30	2	Y-5Q8N2U033084B	1,047

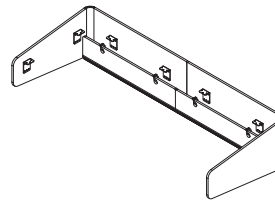
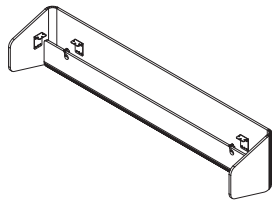

Specify

- Paint Selection
- Color Selection for PET - Lite Grey, Medium Grey, Tan or Vibrant Blue

Notes

- PET U-Wrap Screens are designed to mount to AIS worksurfaces. Specify based on nominal size for the desired system. Order screens that correspond to worksurface width and depth.
- PET screen inserts are 1/2" (12mm) thick.
- U-Wrap screens typically constructed with 2 pieces of PET, some smaller sizes are constructed from 1 piece when possible. See PET pieces column above for reference. See PET pieces column above for reference.
- 3/8" gap allows for installation of clamp-on monitors and accessories.
- Unhooks from worksurface for easy access to wire management. Access from user side.
- Height listed above is above surface height. For additional dimensions see product detail pages.

PET Day-to-Day & Calibrate HAT U-Wrap Enclosures with Wire Managers

Material	Where Used	Screen Type	Sized For	Mount Type
PET	U-Wrap Partial Modesty on WS	Enclosure w/ Wire Manager	Day-to-Day & Calibrate HAT	Under Surface Mount

PET DAY-TO-DAY & CALIBRATE U-WRAP ENCLOSURES WITH WIRE MANAGERS

H	W	D	PET Pieces	Model Number	List
12	42	12	1	Y-5Q8N2U121242B	801
12	48	12	1	Y-5Q8N2U121248B	820
12	54	12	1	Y-5Q8N2U121254B	839
12	60	12	1	Y-5Q8N2U121260B	858
12	66	12	1	Y-5Q8N2U121266B	877
12	72	12	2	Y-5Q8N2U121272B	897
12	78	12	2	Y-5Q8N2U121278B	916
12	84	12	2	Y-5Q8N2U121284B	976
12	42	18	1	Y-5Q8N2U121842B	820
12	48	18	1	Y-5Q8N2U121848B	839
12	54	18	1	Y-5Q8N2U121854B	858
12	60	18	2	Y-5Q8N2U121860B	877
12	66	18	2	Y-5Q8N2U121866B	897
12	72	18	2	Y-5Q8N2U121872B	916
12	78	18	2	Y-5Q8N2U121878B	994
12	84	18	2	Y-5Q8N2U121884B	1,015

PET DAY-TO-DAY & CALIBRATE U-WRAP ENCLOSURES WITH WIRE MANAGERS

H	W	D	PET Pieces	Model Number	List
12	42	24	1	Y-5Q8N2U122442B	839
12	48	24	2	Y-5Q8N2U122448B	858
12	54	24	2	Y-5Q8N2U122454B	877
12	60	24	2	Y-5Q8N2U122460B	897
12	66	24	2	Y-5Q8N2U122466B	916
12	72	24	2	Y-5Q8N2U122472B	1,015
12	78	24	2	Y-5Q8N2U122478B	1,032
12	84	24	2	Y-5Q8N2U122484B	1,051
12	42	30	2	Y-5Q8N2U123042B	858
12	48	30	2	Y-5Q8N2U123048B	877
12	54	30	2	Y-5Q8N2U123054B	897
12	60	30	2	Y-5Q8N2U123060B	916
12	66	30	2	Y-5Q8N2U123066B	1,032
12	72	30	2	Y-5Q8N2U123072B	1,051
12	78	30	2	Y-5Q8N2U123078B	1,071
12	84	30	2	Y-5Q8N2U123084B	1,090

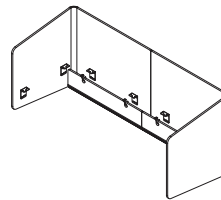
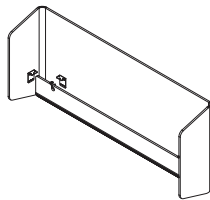

Specify

- Paint Selection
- Color Selection for PET - Lite Grey, Medium Grey, Tan or Vibrant Blue

Notes

- PET U-Wrap Screens are designed to mount to AIS worksurfaces. Specify based on nominal size for the desired system. Order screens that correspond to worksurface width and depth.
- PET screen inserts are 1/2" (12mm) thick.
- U-Wrap screens typically constructed with 2 pieces of PET, some smaller sizes are constructed from 1 piece when possible. See PET pieces column above for reference. See PET pieces column above for reference.
- 3/8" gap allows for installation of clamp-on monitors and accessories.
- Unhooks from worksurface for easy access to wire management. Access from user side.
- Height listed above is above surface height. For additional dimensions see product detail pages.

PET Day-to-Day & Calibrate HAT U-Wrap Enclosures with Wire Managers

Material	Where Used	Screen Type	Sized For	Mount Type
PET	U-Wrap Partial Modesty on WS	Enclosure w/ Wire Manager	Day-to-Day & Calibrate HAT	Under Surface Mount

PET DAY-TO-DAY & CALIBRATE U-WRAP ENCLOSURES WITH WIRE MANAGERS

H	W	D	PET Pieces	Model Number	List
16	42	12	1	Y-5Q8N2U161242B	833
16	48	12	1	Y-5Q8N2U161248B	855
16	54	12	1	Y-5Q8N2U161254B	877
16	60	12	1	Y-5Q8N2U161260B	900
16	66	12	1	Y-5Q8N2U161266B	924
16	72	12	2	Y-5Q8N2U161272B	948
16	78	12	2	Y-5Q8N2U161278B	968
16	84	12	2	Y-5Q8N2U161284B	1,037
16	42	18	1	Y-5Q8N2U161842B	855
16	48	18	1	Y-5Q8N2U161848B	877
16	54	18	1	Y-5Q8N2U161854B	900
16	60	18	2	Y-5Q8N2U161860B	924
16	66	18	2	Y-5Q8N2U161866B	948
16	72	18	2	Y-5Q8N2U161872B	968
16	78	18	2	Y-5Q8N2U161878B	1,060
16	84	18	2	Y-5Q8N2U161884B	1,085

PET DAY-TO-DAY & CALIBRATE U-WRAP ENCLOSURES WITH WIRE MANAGERS

H	W	D	PET Pieces	Model Number	List
16	42	24	1	Y-5Q8N2U162442B	877
16	48	24	2	Y-5Q8N2U162448B	900
16	54	24	2	Y-5Q8N2U162454B	924
16	60	24	2	Y-5Q8N2U162460B	948
16	66	24	2	Y-5Q8N2U162466B	968
16	72	24	2	Y-5Q8N2U162472B	1,085
16	78	24	2	Y-5Q8N2U162478B	1,107
16	84	24	2	Y-5Q8N2U162484B	1,129
16	42	30	2	Y-5Q8N2U163042B	900
16	48	30	2	Y-5Q8N2U163048B	924
16	54	30	2	Y-5Q8N2U163054B	948
16	60	30	2	Y-5Q8N2U163060B	968
16	66	30	2	Y-5Q8N2U163066B	1,107
16	72	30	2	Y-5Q8N2U163072B	1,129
16	78	30	2	Y-5Q8N2U163078B	1,152
16	84	30	2	Y-5Q8N2U163084B	1,173

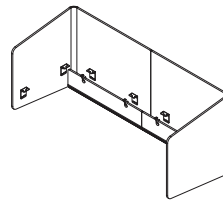
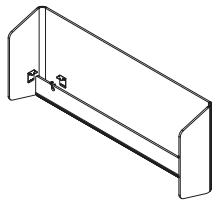

Specify

- Paint Selection
- Color Selection for PET - Lite Grey, Medium Grey, Tan or Vibrant Blue

Notes

- PET U-Wrap Screens are designed to mount to AIS worksurfaces. Specify based on nominal size for the desired system. Order screens that correspond to worksurface width and depth.
- PET screen inserts are 1/2" (12mm) thick.
- U-Wrap screens typically constructed with 2 pieces of PET, some smaller sizes are constructed from 1 piece when possible. See PET pieces column above for reference. See PET pieces column above for reference.
- 3/8" gap allows for installation of clamp-on monitors and accessories.
- Unhooks from worksurface for easy access to wire management. Access from user side.
- Height listed above is above surface height. For additional dimensions see product detail pages.

PET Day-to-Day & Calibrate HAT U-Wrap Enclosures with Wire Managers

Material	Where Used	Screen Type	Sized For	Mount Type
PET	U-Wrap Partial Modesty on WS	Enclosure w/ Wire Manager	Day-to-Day & Calibrate HAT	Under Surface Mount

PET DAY-TO-DAY & CALIBRATE U-WRAP ENCLOSURES WITH WIRE MANAGERS

H	W	D	PET Pieces	Model Number	List
20	42	12	1	Y-5Q8N2U201242B	1,032
20	48	12	1	Y-5Q8N2U201248B	1,070
20	54	12	1	Y-5Q8N2U201254B	1,107
20	60	12	1	Y-5Q8N2U201260B	1,141
20	66	12	1	Y-5Q8N2U201266B	1,179
20	72	12	2	Y-5Q8N2U201272B	1,217
20	78	12	2	Y-5Q8N2U201278B	1,253
20	84	12	2	Y-5Q8N2U201284B	1,289
20	42	18	1	Y-5Q8N2U201842B	1,107
20	48	18	1	Y-5Q8N2U201848B	1,141
20	54	18	1	Y-5Q8N2U201854B	1,179
20	60	18	2	Y-5Q8N2U201860B	1,217
20	66	18	2	Y-5Q8N2U201866B	1,253
20	72	18	2	Y-5Q8N2U201872B	1,289
20	78	18	2	Y-5Q8N2U201878B	1,327
20	84	18	2	Y-5Q8N2U201884B	1,363

PET DAY-TO-DAY & CALIBRATE U-WRAP ENCLOSURES WITH WIRE MANAGERS

H	W	D	PET Pieces	Model Number	List
20	42	24	1	Y-5Q8N2U202442B	1,179
20	48	24	2	Y-5Q8N2U202448B	1,217
20	54	24	2	Y-5Q8N2U202454B	1,253
20	60	24	2	Y-5Q8N2U202460B	1,289
20	66	24	2	Y-5Q8N2U202466B	1,327
20	72	24	2	Y-5Q8N2U202472B	1,363
20	78	24	2	Y-5Q8N2U202478B	1,402
20	84	24	2	Y-5Q8N2U202484B	1,438
20	42	30	2	Y-5Q8N2U203042B	1,253
20	48	30	2	Y-5Q8N2U203048B	1,289
20	54	30	2	Y-5Q8N2U203054B	1,327
20	60	30	2	Y-5Q8N2U203060B	1,363
20	66	30	2	Y-5Q8N2U203066B	1,402
20	72	30	2	Y-5Q8N2U203072B	1,438
20	78	30	2	Y-5Q8N2U203078B	1,475
20	84	30	2	Y-5Q8N2U203084B	1,511

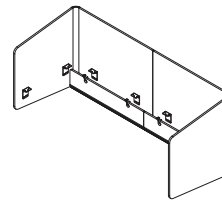
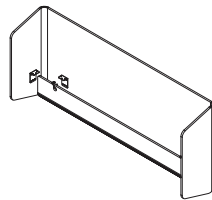

Specify

- Paint Selection
- Color Selection for PET - Lite Grey, Medium Grey, Tan or Vibrant Blue

Notes

- PET U-Wrap Screens are designed to mount to AIS worksurfaces. Specify based on nominal size for the desired system. Order screens that correspond to worksurface width and depth.
- PET screen inserts are 1/2" (12mm) thick.
- U-Wrap screens typically constructed with 2 pieces of PET, some smaller sizes are constructed from 1 piece when possible. See PET pieces column above for reference. See PET pieces column above for reference.
- 3/8" gap allows for installation of clamp-on monitors and accessories.
- Unhooks from worksurface for easy access to wire management. Access from user side.
- Height listed above is above surface height. For additional dimensions see product detail pages.

PET Day-to-Day & Calibrate HAT U-Wrap Enclosures with Wire Managers

Material	Where Used	Screen Type	Sized For	Mount Type
PET	U-Wrap Partial Modesty on WS	Enclosure w/ Wire Manager	Day-to-Day & Calibrate HAT	Under Surface Mount

PET DAY-TO-DAY & CALIBRATE U-WRAP ENCLOSURES WITH WIRE MANAGERS

H	W	D	PET Pieces	Model Number	List
24	42	12	1	Y-5Q8N2U241242B	1,003
24	48	12	1	Y-5Q8N2U241248B	1,046
24	54	12	1	Y-5Q8N2U241254B	1,087
24	60	12	1	Y-5Q8N2U241260B	1,128
24	66	12	1	Y-5Q8N2U241266B	1,169
24	72	12	2	Y-5Q8N2U241272B	1,210
24	78	12	2	Y-5Q8N2U241278B	1,253
24	84	12	2	Y-5Q8N2U241284B	1,379
24	42	18	1	Y-5Q8N2U241842B	1,046
24	48	18	1	Y-5Q8N2U241848B	1,087
24	54	18	1	Y-5Q8N2U241854B	1,128
24	60	18	2	Y-5Q8N2U241860B	1,169
24	66	18	2	Y-5Q8N2U241866B	1,210
24	72	18	2	Y-5Q8N2U241872B	1,253
24	78	18	2	Y-5Q8N2U241878B	1,420
24	84	18	2	Y-5Q8N2U241884B	1,461

PET DAY-TO-DAY & CALIBRATE U-WRAP ENCLOSURES WITH WIRE MANAGERS

H	W	D	PET Pieces	Model Number	List
24	42	24	1	Y-5Q8N2U242442B	1,087
24	48	24	2	Y-5Q8N2U242448B	1,128
24	54	24	2	Y-5Q8N2U242454B	1,169
24	60	24	2	Y-5Q8N2U242460B	1,210
24	66	24	2	Y-5Q8N2U242466B	1,253
24	72	24	2	Y-5Q8N2U242472B	1,461
24	78	24	2	Y-5Q8N2U242478B	1,503
24	84	24	2	Y-5Q8N2U242484B	1,546
24	42	30	2	Y-5Q8N2U243042B	1,128
24	48	30	2	Y-5Q8N2U243048B	1,169
24	54	30	2	Y-5Q8N2U243054B	1,210
24	60	30	2	Y-5Q8N2U243060B	1,253
24	66	30	2	Y-5Q8N2U243066B	1,503
24	72	30	2	Y-5Q8N2U243072B	1,546
24	78	30	2	Y-5Q8N2U243078B	1,587
24	84	30	2	Y-5Q8N2U243084B	1,629

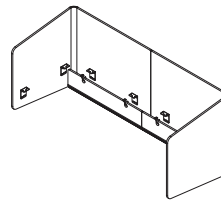
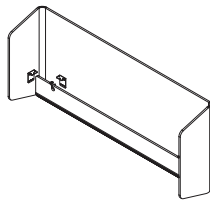

Specify

- Paint Selection
- Color Selection for PET - Lite Grey, Medium Grey, Tan or Vibrant Blue

Notes

- PET U-Wrap Screens are designed to mount to AIS worksurfaces. Specify based on nominal size for the desired system. Order screens that correspond to worksurface width and depth.
- PET screen inserts are 1/2" (12mm) thick.
- U-Wrap screens typically constructed with 2 pieces of PET, some smaller sizes are constructed from 1 piece when possible. See PET pieces column above for reference. See PET pieces column above for reference.
- 3/8" gap allows for installation of clamp-on monitors and accessories.
- Unhooks from worksurface for easy access to wire management. Access from user side.
- Height listed above is above surface height. For additional dimensions see product detail pages.

PET Day-to-Day & Calibrate HAT U-Wrap Enclosures with Wire Managers

Material	Where Used	Screen Type	Sized For	Mount Type
PET	U-Wrap Partial Modesty on WS	Enclosure w/ Wire Manager	Day-to-Day & Calibrate HAT	Under Surface Mount

PET DAY-TO-DAY & CALIBRATE U-WRAP ENCLOSURES WITH WIRE MANAGERS

H	W	D	PET Pieces	Model Number	List
28	42	12	1	Y-5Q8N2U281242B	1,047
28	48	12	1	Y-5Q8N2U281248B	1,093
28	54	12	1	Y-5Q8N2U281254B	1,140
28	60	12	1	Y-5Q8N2U281260B	1,184
28	66	12	1	Y-5Q8N2U281266B	1,234
28	72	12	2	Y-5Q8N2U281272B	1,280
28	78	12	2	Y-5Q8N2U281278B	1,327
28	84	12	2	Y-5Q8N2U281284B	1,466
28	42	18	1	Y-5Q8N2U281842B	1,093
28	48	18	1	Y-5Q8N2U281848B	1,140
28	54	18	1	Y-5Q8N2U281854B	1,184
28	60	18	2	Y-5Q8N2U281860B	1,234
28	66	18	2	Y-5Q8N2U281866B	1,280
28	72	18	2	Y-5Q8N2U281872B	1,327
28	78	18	2	Y-5Q8N2U281878B	1,512
28	84	18	2	Y-5Q8N2U281884B	1,561

PET DAY-TO-DAY & CALIBRATE U-WRAP ENCLOSURES WITH WIRE MANAGERS

H	W	D	PET Pieces	Model Number	List
28	42	24	1	Y-5Q8N2U282442B	1,140
28	48	24	2	Y-5Q8N2U282448B	1,184
28	54	24	2	Y-5Q8N2U282454B	1,234
28	60	24	2	Y-5Q8N2U282460B	1,280
28	66	24	2	Y-5Q8N2U282466B	1,327
28	72	24	2	Y-5Q8N2U282472B	1,561
28	78	24	2	Y-5Q8N2U282478B	1,606
28	84	24	2	Y-5Q8N2U282484B	1,654
28	42	30	2	Y-5Q8N2U283042B	1,184
28	48	30	2	Y-5Q8N2U283048B	1,234
28	54	30	2	Y-5Q8N2U283054B	1,280
28	60	30	2	Y-5Q8N2U283060B	1,327
28	66	30	2	Y-5Q8N2U283066B	1,606
28	72	30	2	Y-5Q8N2U283072B	1,654
28	78	30	2	Y-5Q8N2U283078B	1,700
28	84	30	2	Y-5Q8N2U283084B	1,746

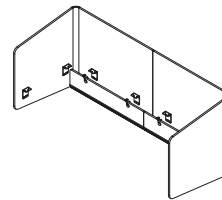
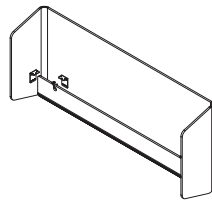

Specify

- Paint Selection
- Color Selection for PET - Lite Grey, Medium Grey, Tan or Vibrant Blue

Notes

- PET U-Wrap Screens are designed to mount to AIS worksurfaces. Specify based on nominal size for the desired system. Order screens that correspond to worksurface width and depth.
- PET screen inserts are 1/2" (12mm) thick.
- U-Wrap screens typically constructed with 2 pieces of PET, some smaller sizes are constructed from 1 piece when possible. See PET pieces column above for reference. See PET pieces column above for reference.
- 3/8" gap allows for installation of clamp-on monitors and accessories.
- Unhooks from worksurface for easy access to wire management. Access from user side.
- Height listed above is above surface height. For additional dimensions see product detail pages.

PET Benching HAT U-Wrap Enclosures with Wire Managers

Material	Where Used	Screen Type	Sized For	Mount Type
PET	U-Wrap Partial Modesty on WS	Enclosure w/ Wire Manager	Benching HAT	Under Surface Mount

PET BENCHING HAT U-WRAP ENCLOSURES WITH WIRE MANAGERS

H	W	D	PET Pieces	Model Number	List
3	42	12	1	Y-5Q8P2U031242B	768
3	48	12	1	Y-5Q8P2U031248B	788
3	54	12	1	Y-5Q8P2U031254B	806
3	60	12	1	Y-5Q8P2U031260B	825
3	66	12	1	Y-5Q8P2U031266B	843
3	72	12	2	Y-5Q8P2U031272B	860
3	78	12	2	Y-5Q8P2U031278B	880
3	84	12	2	Y-5Q8P2U031284B	936
3	42	18	1	Y-5Q8P2U031842B	788
3	48	18	1	Y-5Q8P2U031848B	806
3	54	18	1	Y-5Q8P2U031854B	825
3	60	18	2	Y-5Q8P2U031860B	843
3	66	18	2	Y-5Q8P2U031866B	860
3	72	18	2	Y-5Q8P2U031872B	880
3	78	18	2	Y-5Q8P2U031878B	954
3	84	18	2	Y-5Q8P2U031884B	972

PET BENCHING HAT U-WRAP ENCLOSURES WITH WIRE MANAGERS

H	W	D	PET Pieces	Model Number	List
3	42	24	1	Y-5Q8P2U032442B	806
3	48	24	2	Y-5Q8P2U032448B	825
3	54	24	2	Y-5Q8P2U032454B	843
3	60	24	2	Y-5Q8P2U032460B	860
3	66	24	2	Y-5Q8P2U032466B	880
3	72	24	2	Y-5Q8P2U032472B	972
3	78	24	2	Y-5Q8P2U032478B	991
3	84	24	2	Y-5Q8P2U032484B	1,010
3	42	30	2	Y-5Q8P2U033042B	825
3	48	30	2	Y-5Q8P2U033048B	843
3	54	30	2	Y-5Q8P2U033054B	860
3	60	30	2	Y-5Q8P2U033060B	880
3	66	30	2	Y-5Q8P2U033066B	991
3	72	30	2	Y-5Q8P2U033072B	1,010
3	78	30	2	Y-5Q8P2U033078B	1,029
3	84	30	2	Y-5Q8P2U033084B	1,047

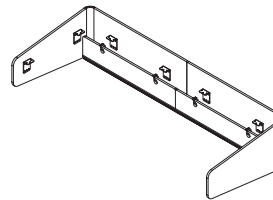
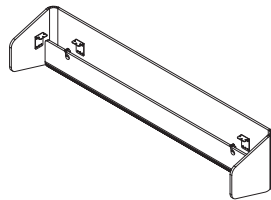

Specify

- Paint Selection
- Color Selection for PET - Lite Grey, Medium Grey, Tan or Vibrant Blue

Notes

- PET U-Wrap Screens are designed to mount to AIS worksurfaces. Specify based on nominal size for the desired system. Order screens that correspond to worksurface width and depth.
- PET screen inserts are 1/2" (12mm) thick.
- U-Wrap screens typically constructed with 2 pieces of PET, some smaller sizes are constructed from 1 piece when possible. See PET pieces column above for reference. See PET pieces column above for reference.
- 3/8" gap allows for installation of clamp-on monitors and accessories.
- Unhooks from worksurface for easy access to wire management. Access from user side.
- Height listed above is above surface height. For additional dimensions see product detail pages.

PET Benching HAT U-Wrap Enclosures with Wire Managers

Material	Where Used	Screen Type	Sized For	Mount Type
PET	U-Wrap Partial Modesty on WS	Enclosure w/ Wire Manager	Benching HAT	Under Surface Mount

PET BENCHING HAT U-WRAP ENCLOSURES WITH WIRE MANAGERS

H	W	D	PET Pieces	Model Number	List
12	42	12	1	Y-5Q8P2U121242B	801
12	48	12	1	Y-5Q8P2U121248B	820
12	54	12	1	Y-5Q8P2U121254B	839
12	60	12	1	Y-5Q8P2U121260B	858
12	66	12	1	Y-5Q8P2U121266B	877
12	72	12	2	Y-5Q8P2U121272B	897
12	78	12	2	Y-5Q8P2U121278B	916
12	84	12	2	Y-5Q8P2U121284B	976
12	42	18	1	Y-5Q8P2U121842B	820
12	48	18	1	Y-5Q8P2U121848B	839
12	54	18	1	Y-5Q8P2U121854B	858
12	60	18	2	Y-5Q8P2U121860B	877
12	66	18	2	Y-5Q8P2U121866B	897
12	72	18	2	Y-5Q8P2U121872B	916
12	78	18	2	Y-5Q8P2U121878B	994
12	84	18	2	Y-5Q8P2U121884B	1,015

PET BENCHING HAT U-WRAP ENCLOSURES WITH WIRE MANAGERS

H	W	D	PET Pieces	Model Number	List
12	42	24	1	Y-5Q8P2U122442B	839
12	48	24	2	Y-5Q8P2U122448B	858
12	54	24	2	Y-5Q8P2U122454B	877
12	60	24	2	Y-5Q8P2U122460B	897
12	66	24	2	Y-5Q8P2U122466B	916
12	72	24	2	Y-5Q8P2U122472B	1,015
12	78	24	2	Y-5Q8P2U122478B	1,032
12	84	24	2	Y-5Q8P2U122484B	1,051
12	42	30	2	Y-5Q8P2U123042B	858
12	48	30	2	Y-5Q8P2U123048B	877
12	54	30	2	Y-5Q8P2U123054B	897
12	60	30	2	Y-5Q8P2U123060B	916
12	66	30	2	Y-5Q8P2U123066B	1,032
12	72	30	2	Y-5Q8P2U123072B	1,051
12	78	30	2	Y-5Q8P2U123078B	1,071
12	84	30	2	Y-5Q8P2U123084B	1,090

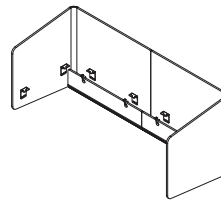
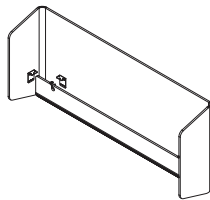

Specify

- Paint Selection
- Color Selection for PET - Lite Grey, Medium Grey, Tan or Vibrant Blue

Notes

- PET U-Wrap Screens are designed to mount to AIS worksurfaces. Specify based on nominal size for the desired system. Order screens that correspond to worksurface width and depth.
- PET screen inserts are 1/2" (12mm) thick.
- U-Wrap screens typically constructed with 2 pieces of PET, some smaller sizes are constructed from 1 piece when possible. See PET pieces column above for reference. See PET pieces column above for reference.
- 3/8" gap allows for installation of clamp-on monitors and accessories.
- Unhooks from worksurface for easy access to wire management. Access from user side.
- Height listed above is above surface height. For additional dimensions see product detail pages.

PET Benching HAT U-Wrap Enclosures with Wire Managers

Material	Where Used	Screen Type	Sized For	Mount Type
PET	U-Wrap Partial Modesty on WS	Enclosure w/ Wire Manager	Benching HAT	Under Surface Mount

PET BENCHING HAT U-WRAP ENCLOSURES WITH WIRE MANAGERS

H	W	D	PET Pieces	Model Number	List
16	42	12	1	Y-5Q8P2U161242B	833
16	48	12	1	Y-5Q8P2U161248B	855
16	54	12	1	Y-5Q8P2U161254B	877
16	60	12	1	Y-5Q8P2U161260B	900
16	66	12	1	Y-5Q8P2U161266B	924
16	72	12	2	Y-5Q8P2U161272B	948
16	78	12	2	Y-5Q8P2U161278B	968
16	84	12	2	Y-5Q8P2U161284B	1,037
16	42	18	1	Y-5Q8P2U161842B	855
16	48	18	1	Y-5Q8P2U161848B	877
16	54	18	1	Y-5Q8P2U161854B	900
16	60	18	2	Y-5Q8P2U161860B	924
16	66	18	2	Y-5Q8P2U161866B	948
16	72	18	2	Y-5Q8P2U161872B	968
16	78	18	2	Y-5Q8P2U161878B	1,060
16	84	18	2	Y-5Q8P2U161884B	1,085

PET BENCHING HAT U-WRAP ENCLOSURES WITH WIRE MANAGERS

H	W	D	PET Pieces	Model Number	List
16	42	24	1	Y-5Q8P2U162442B	877
16	48	24	2	Y-5Q8P2U162448B	900
16	54	24	2	Y-5Q8P2U162454B	924
16	60	24	2	Y-5Q8P2U162460B	948
16	66	24	2	Y-5Q8P2U162466B	968
16	72	24	2	Y-5Q8P2U162472B	1,085
16	78	24	2	Y-5Q8P2U162478B	1,107
16	84	24	2	Y-5Q8P2U162484B	1,129
16	42	30	2	Y-5Q8P2U163042B	900
16	48	30	2	Y-5Q8P2U163048B	924
16	54	30	2	Y-5Q8P2U163054B	948
16	60	30	2	Y-5Q8P2U163060B	968
16	66	30	2	Y-5Q8P2U163066B	1,107
16	72	30	2	Y-5Q8P2U163072B	1,129
16	78	30	2	Y-5Q8P2U163078B	1,152
16	84	30	2	Y-5Q8P2U163084B	1,173

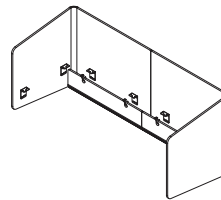
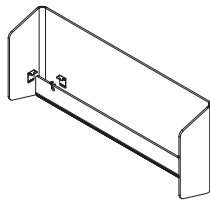

Specify

- Paint Selection
- Color Selection for PET - Lite Grey, Medium Grey, Tan or Vibrant Blue

Notes

- PET U-Wrap Screens are designed to mount to AIS worksurfaces. Specify based on nominal size for the desired system. Order screens that correspond to worksurface width and depth.
- PET screen inserts are 1/2" (12mm) thick.
- U-Wrap screens typically constructed with 2 pieces of PET, some smaller sizes are constructed from 1 piece when possible. See PET pieces column above for reference. See PET pieces column above for reference.
- 3/8" gap allows for installation of clamp-on monitors and accessories.
- Unhooks from worksurface for easy access to wire management. Access from user side.
- Height listed above is above surface height. For additional dimensions see product detail pages.

PET Benching HAT U-Wrap Enclosures with Wire Managers

Material	Where Used	Screen Type	Sized For	Mount Type
PET	U-Wrap Partial Modesty on WS	Enclosure w/ Wire Manager	Benching HAT	Under Surface Mount

PET BENCHING HAT U-WRAP ENCLOSURES WITH WIRE MANAGERS

H	W	D	PET Pieces	Model Number	List
20	42	12	1	Y-5Q8P2U201242B	1,032
20	48	12	1	Y-5Q8P2U201248B	1,070
20	54	12	1	Y-5Q8P2U201254B	1,107
20	60	12	1	Y-5Q8P2U201260B	1,141
20	66	12	1	Y-5Q8P2U201266B	1,179
20	72	12	2	Y-5Q8P2U201272B	1,217
20	78	12	2	Y-5Q8P2U201278B	1,253
20	84	12	2	Y-5Q8P2U201284B	1,289
20	42	18	1	Y-5Q8P2U201842B	1,107
20	48	18	1	Y-5Q8P2U201848B	1,141
20	54	18	1	Y-5Q8P2U201854B	1,179
20	60	18	2	Y-5Q8P2U201860B	1,217
20	66	18	2	Y-5Q8P2U201866B	1,253
20	72	18	2	Y-5Q8P2U201872B	1,289
20	78	18	2	Y-5Q8P2U201878B	1,327
20	84	18	2	Y-5Q8P2U201884B	1,363

PET BENCHING HAT U-WRAP ENCLOSURES WITH WIRE MANAGERS

H	W	D	PET Pieces	Model Number	List
20	42	24	1	Y-5Q8P2U202442B	1,179
20	48	24	2	Y-5Q8P2U202448B	1,217
20	54	24	2	Y-5Q8P2U202454B	1,253
20	60	24	2	Y-5Q8P2U202460B	1,289
20	66	24	2	Y-5Q8P2U202466B	1,327
20	72	24	2	Y-5Q8P2U202472B	1,363
20	78	24	2	Y-5Q8P2U202478B	1,402
20	84	24	2	Y-5Q8P2U202484B	1,438
20	42	30	2	Y-5Q8P2U203042B	1,253
20	48	30	2	Y-5Q8P2U203048B	1,289
20	54	30	2	Y-5Q8P2U203054B	1,327
20	60	30	2	Y-5Q8P2U203060B	1,363
20	66	30	2	Y-5Q8P2U203066B	1,402
20	72	30	2	Y-5Q8P2U203072B	1,438
20	78	30	2	Y-5Q8P2U203078B	1,475
20	84	30	2	Y-5Q8P2U203084B	1,511

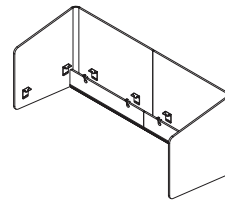
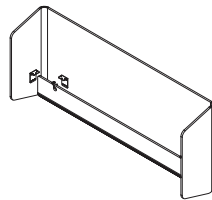

Specify

- Paint Selection
- Color Selection for PET - Lite Grey, Medium Grey, Tan or Vibrant Blue

Notes

- PET U-Wrap Screens are designed to mount to AIS worksurfaces. Specify based on nominal size for the desired system. Order screens that correspond to worksurface width and depth.
- PET screen inserts are 1/2" (12mm) thick.
- U-Wrap screens typically constructed with 2 pieces of PET, some smaller sizes are constructed from 1 piece when possible. See PET pieces column above for reference. See PET pieces column above for reference.
- 3/8" gap allows for installation of clamp-on monitors and accessories.
- Unhooks from worksurface for easy access to wire management. Access from user side.
- Height listed above is above surface height. For additional dimensions see product detail pages.

PET Benching HAT U-Wrap Enclosures with Wire Managers

Material	Where Used	Screen Type	Sized For	Mount Type
PET	U-Wrap Partial Modesty on WS	Enclosure w/ Wire Manager	Benching HAT	Under Surface Mount

PET BENCHING HAT U-WRAP ENCLOSURES WITH WIRE MANAGERS

H	W	D	PET Pieces	Model Number	List
24	42	12	1	Y-5Q8P2U241242B	1,003
24	48	12	1	Y-5Q8P2U241248B	1,046
24	54	12	1	Y-5Q8P2U241254B	1,087
24	60	12	1	Y-5Q8P2U241260B	1,128
24	66	12	1	Y-5Q8P2U241266B	1,169
24	72	12	2	Y-5Q8P2U241272B	1,210
24	78	12	2	Y-5Q8P2U241278B	1,253
24	84	12	2	Y-5Q8P2U241284B	1,379
24	42	18	1	Y-5Q8P2U241842B	1,046
24	48	18	1	Y-5Q8P2U241848B	1,087
24	54	18	1	Y-5Q8P2U241854B	1,128
24	60	18	2	Y-5Q8P2U241860B	1,169
24	66	18	2	Y-5Q8P2U241866B	1,210
24	72	18	2	Y-5Q8P2U241872B	1,253
24	78	18	2	Y-5Q8P2U241878B	1,420
24	84	18	2	Y-5Q8P2U241884B	1,461

PET BENCHING HAT U-WRAP ENCLOSURES WITH WIRE MANAGERS

H	W	D	PET Pieces	Model Number	List
24	42	24	1	Y-5Q8P2U242442B	1,087
24	48	24	2	Y-5Q8P2U242448B	1,128
24	54	24	2	Y-5Q8P2U242454B	1,169
24	60	24	2	Y-5Q8P2U242460B	1,210
24	66	24	2	Y-5Q8P2U242466B	1,253
24	72	24	2	Y-5Q8P2U242472B	1,461
24	78	24	2	Y-5Q8P2U242478B	1,503
24	84	24	2	Y-5Q8P2U242484B	1,546
24	42	30	2	Y-5Q8P2U243042B	1,128
24	48	30	2	Y-5Q8P2U243048B	1,169
24	54	30	2	Y-5Q8P2U243054B	1,210
24	60	30	2	Y-5Q8P2U243060B	1,253
24	66	30	2	Y-5Q8P2U243066B	1,503
24	72	30	2	Y-5Q8P2U243072B	1,546
24	78	30	2	Y-5Q8P2U243078B	1,587
24	84	30	2	Y-5Q8P2U243084B	1,629

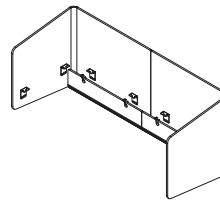
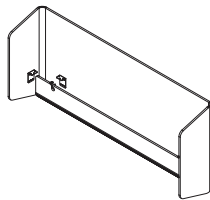

Specify

- Paint Selection
- Color Selection for PET - Lite Grey, Medium Grey, Tan or Vibrant Blue

Notes

- PET U-Wrap Screens are designed to mount to AIS worksurfaces. Specify based on nominal size for the desired system. Order screens that correspond to worksurface width and depth.
- PET screen inserts are 1/2" (12mm) thick.
- U-Wrap screens typically constructed with 2 pieces of PET, some smaller sizes are constructed from 1 piece when possible. See PET pieces column above for reference. See PET pieces column above for reference.
- 3/8" gap allows for installation of clamp-on monitors and accessories.
- Unhooks from worksurface for easy access to wire management. Access from user side.
- Height listed above is above surface height. For additional dimensions see product detail pages.

PET Benching HAT U-Wrap Enclosures with Wire Managers

Material	Where Used	Screen Type	Sized For	Mount Type
PET	U-Wrap Partial Modesty on WS	Enclosure w/ Wire Manager	Benching HAT	Under Surface Mount

PET BENCHING HAT U-WRAP ENCLOSURES WITH WIRE MANAGERS

H	W	D	PET Pieces	Model Number	List
28	42	12	1	Y-5Q8P2U281242B	1,047
28	48	12	1	Y-5Q8P2U281248B	1,093
28	54	12	1	Y-5Q8P2U281254B	1,140
28	60	12	1	Y-5Q8P2U281260B	1,184
28	66	12	1	Y-5Q8P2U281266B	1,234
28	72	12	2	Y-5Q8P2U281272B	1,280
28	78	12	2	Y-5Q8P2U281278B	1,327
28	84	12	2	Y-5Q8P2U281284B	1,466
28	42	18	1	Y-5Q8P2U281842B	1,093
28	48	18	1	Y-5Q8P2U281848B	1,140
28	54	18	1	Y-5Q8P2U281854B	1,184
28	60	18	2	Y-5Q8P2U281860B	1,234
28	66	18	2	Y-5Q8P2U281866B	1,280
28	72	18	2	Y-5Q8P2U281872B	1,327
28	78	18	2	Y-5Q8P2U281878B	1,512
28	84	18	2	Y-5Q8P2U281884B	1,561

PET BENCHING HAT U-WRAP ENCLOSURES WITH WIRE MANAGERS

H	W	D	PET Pieces	Model Number	List
28	42	24	1	Y-5Q8P2U282442B	1,140
28	48	24	2	Y-5Q8P2U282448B	1,184
28	54	24	2	Y-5Q8P2U282454B	1,234
28	60	24	2	Y-5Q8P2U282460B	1,280
28	66	24	2	Y-5Q8P2U282466B	1,327
28	72	24	2	Y-5Q8P2U282472B	1,561
28	78	24	2	Y-5Q8P2U282478B	1,606
28	84	24	2	Y-5Q8P2U282484B	1,654
28	42	30	2	Y-5Q8P2U283042B	1,184
28	48	30	2	Y-5Q8P2U283048B	1,234
28	54	30	2	Y-5Q8P2U283054B	1,280
28	60	30	2	Y-5Q8P2U283060B	1,327
28	66	30	2	Y-5Q8P2U283066B	1,606
28	72	30	2	Y-5Q8P2U283072B	1,654
28	78	30	2	Y-5Q8P2U283078B	1,700
28	84	30	2	Y-5Q8P2U283084B	1,746

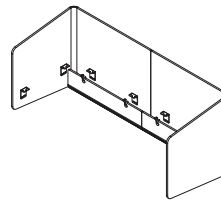
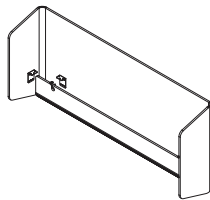

Specify

- Paint Selection
- Color Selection for PET - Lite Grey, Medium Grey, Tan or Vibrant Blue

Notes

- PET U-Wrap Screens are designed to mount to AIS worksurfaces. Specify based on nominal size for the desired system. Order screens that correspond to worksurface width and depth.
- PET screen inserts are 1/2" (12mm) thick.
- U-Wrap screens typically constructed with 2 pieces of PET, some smaller sizes are constructed from 1 piece when possible. See PET pieces column above for reference. See PET pieces column above for reference.
- 3/8" gap allows for installation of clamp-on monitors and accessories.
- Unhooks from worksurface for easy access to wire management. Access from user side.
- Height listed above is above surface height. For additional dimensions see product detail pages.

PET Screens with Wire Managers

PET Nominal = Actual Size Screens with Wire Managers

Material	Where Used	Screen Type	Sized For	Mount Type
PET	Partial Modesty on WS	Screen w/ Wire Manager	Nominal = Actual Size	Under Surface Mount

PET NOMINAL = ACTUAL SIZE SCREENS WITH WIRE MANAGERS

H	W	Model Number	List
3	42	Y-5S7A2U0342B	609
3	48	Y-5S7A2U0348B	629
3	54	Y-5S7A2U0354B	652
3	60	Y-5S7A2U0360B	672
3	66	Y-5S7A2U0366B	693
3	72	Y-5S7A2U0372B	713
3	78	Y-5S7A2U0378B	736
3	84	Y-5S7A2U0384B	765
12	42	Y-5S7A2U1242B	634
12	48	Y-5S7A2U1248B	655
12	54	Y-5S7A2U1254B	678
12	60	Y-5S7A2U1260B	699
12	66	Y-5S7A2U1266B	722
12	72	Y-5S7A2U1272B	744
12	78	Y-5S7A2U1278B	766
12	84	Y-5S7A2U1284B	796
16	42	Y-5S7A2U1642B	661
16	48	Y-5S7A2U1648B	683
16	54	Y-5S7A2U1654B	706
16	60	Y-5S7A2U1660B	728
16	66	Y-5S7A2U1666B	752
16	72	Y-5S7A2U1672B	775
16	78	Y-5S7A2U1678B	798
16	84	Y-5S7A2U1684B	830

PET NOMINAL = ACTUAL SIZE SCREENS WITH WIRE MANAGERS

H	W	Model Number	List
20	42	Y-5S7A2U2042B	682
20	48	Y-5S7A2U2048B	710
20	54	Y-5S7A2U2054B	738
20	60	Y-5S7A2U2060B	767
20	66	Y-5S7A2U2066B	796
20	72	Y-5S7A2U2072B	825
20	78	Y-5S7A2U2078B	854
20	84	Y-5S7A2U2084B	887
24	42	Y-5S7A2U2442B	710
24	48	Y-5S7A2U2448B	739
24	54	Y-5S7A2U2454B	768
24	60	Y-5S7A2U2460B	799
24	66	Y-5S7A2U2466B	830
24	72	Y-5S7A2U2472B	858
24	78	Y-5S7A2U2478B	888
24	84	Y-5S7A2U2484B	925
28	42	Y-5S7A2U2842B	735
28	48	Y-5S7A2U2848B	767
28	54	Y-5S7A2U2854B	801
28	60	Y-5S7A2U2860B	835
28	66	Y-5S7A2U2866B	869
28	72	Y-5S7A2U2872B	900
28	78	Y-5S7A2U2878B	935
28	84	Y-5S7A2U2884B	970

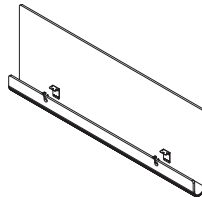

Specify

Notes

- Paint Selection
- Color Selection for PET - Lite Grey, Medium Grey, Tan or Vibrant Blue

- PET Screens are designed to mount to AIS worksurfaces. Specify based on system it is paired with.
- PET screen inserts are 1/2" (12mm) thick.
- 3/8" gap allows for installation of clamp-on monitors and accessories.
- Unhooks from worksurface for easy access to wire management. Access from user side.

PET Day-to-Day, Calibrate & Benching HAT Screens with Wire Managers

Material	Where Used	Screen Type	Sized For	Mount Type
PET	Partial Modesty on WS	Screen w/ Wire Manager	Day-to-Day, Calibrate & Benching HAT Width	Under Surface Mount

PET DAY-TO-DAY, CALIBRATE & BENCHING HAT SCREENS WITH WIRE MANAGERS

H	W	Model Number	List
3	42	Y-5S7G2U0342B	609
3	48	Y-5S7G2U0348B	629
3	54	Y-5S7G2U0354B	652
3	60	Y-5S7G2U0360B	672
3	66	Y-5S7G2U0366B	693
3	72	Y-5S7G2U0372B	713
3	78	Y-5S7G2U0378B	736
3	84	Y-5S7G2U0384B	765
12	42	Y-5S7G2U1242B	634
12	48	Y-5S7G2U1248B	655
12	54	Y-5S7G2U1254B	678
12	60	Y-5S7G2U1260B	699
12	66	Y-5S7G2U1266B	722
12	72	Y-5S7G2U1272B	744
12	78	Y-5S7G2U1278B	766
12	84	Y-5S7G2U1284B	796
16	42	Y-5S7G2U1642B	661
16	48	Y-5S7G2U1648B	683
16	54	Y-5S7G2U1654B	706
16	60	Y-5S7G2U1660B	728
16	66	Y-5S7G2U1666B	752
16	72	Y-5S7G2U1672B	775
16	78	Y-5S7G2U1678B	798
16	84	Y-5S7G2U1684B	830

PET DAY-TO-DAY, CALIBRATE & BENCHING HAT SCREENS WITH WIRE MANAGERS

H	W	Model Number	List
20	42	Y-5S7G2U2042B	682
20	48	Y-5S7G2U2048B	710
20	54	Y-5S7G2U2054B	738
20	60	Y-5S7G2U2060B	767
20	66	Y-5S7G2U2066B	796
20	72	Y-5S7G2U2072B	825
20	78	Y-5S7G2U2078B	854
20	84	Y-5S7G2U2084B	887
24	42	Y-5S7G2U2442B	710
24	48	Y-5S7G2U2448B	739
24	54	Y-5S7G2U2454B	768
24	60	Y-5S7G2U2460B	799
24	66	Y-5S7G2U2466B	830
24	72	Y-5S7G2U2472B	858
24	78	Y-5S7G2U2478B	888
24	84	Y-5S7G2U2484B	925
28	42	Y-5S7G2U2842B	735
28	48	Y-5S7G2U2848B	767
28	54	Y-5S7G2U2854B	801
28	60	Y-5S7G2U2860B	835
28	66	Y-5S7G2U2866B	869
28	72	Y-5S7G2U2872B	900
28	78	Y-5S7G2U2878B	935
28	84	Y-5S7G2U2884B	970

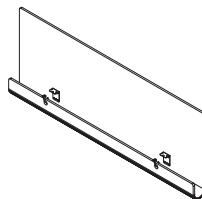

Specify

- Paint Selection
- Color Selection for PET - Lite Grey, Medium Grey, Tan or Vibrant Blue

Notes

- PET Screens are designed to mount to AIS worksurfaces. Specify based on system it is paired with.
- PET screen inserts are 1/2" (12mm) thick.
- 3/8" gap allows for installation of clamp-on monitors and accessories.
- Unhooks from worksurface for easy access to wire management. Access from user side.



National Showrooms:

Leominster

AIS Headquarters
25 Tucker Drive
Leominster, MA 01453

Chicago

The Merchandise Mart
Suite 1086
Chicago, Illinois 60654

New York

AIS New York
257 Park Avenue South
New York, New York 10010

Washington, D.C.

AIS Washington, D.C.
1501 M St, NW, STE 230
Washington, D.C. 20005

GSA Sales

GSA Contract 47QSM20D08Q4
Multiple Award Schedule (MAS)
Large Category: Furniture & Furnishings
Subcategories: Office Furniture, Packaged
Office Furniture and Furniture Services

For additional information on AIS:

Dealer Showrooms, Representative
Directory, Project Case Studies, Online
Catalog & Product Showcase
Visit: www.ais-inc.com