

POWERBEAM POWERBENCH

March 2023 Price List

AIS

PRODUCT INFORMATION

PowerBeam Statement of Line 4
 PowerBeam Finish Options 6
 PowerBeam Typicals 9
 PowerBeam Product Details 13
 PowerBench Typicals 17
 PowerBench Product Details 19

SPINE BEAM KITS

Non-Powered and Single Sided Powered Spine Beam Kits 28
 Powered and Chicago Powered Spine Beam Kits 29

LEGS

Legs for 21" High Spine Beams 30
 Legs for 25" High Spine Beams 31
 Legs for 29" High Spine Beams 32

SPINE BEAM CONNECTORS

Endcaps, Supports, Flush Mount Connection Kits and Wall Anchor Brackets. 33
 90° and 120° Connection Kits 34

GALLERY PANELS

Product Details 35
 Laminate Gallery Panels – Beam Mount, Single End 37
 Laminate Gallery Panels – Beam Mount, Double End 45
 Laminate Gallery Panels – Beam Mount for Wing, Single End 51
 Laminate Gallery Panels – Mid Mount End 57
 Laminate Gallery Panels – Mid Mount End for Wing 65
 Laminate Gallery Panels – Beam Mount Single Spine 71
 Laminate Gallery Panels – Beam Mount Double Spine 79
 Laminate Gallery Panels – Beam Mount Single Spine for Wing 85
 Laminate Gallery Panels – Mid Mount Spine 91
 Laminate Gallery Panels – Mid Mount Spine for Wing 99
 Laminate Gallery Wing Panels 105
 Wall Mounted Gallery Panels 106
 Wall Mounted Gallery Panel for Wings 109

SPINE SCREENS

Glass 1/4" Universal Spine Insert Screens 110
 Glass 3/8" Universal Spine Insert Screens 111
 Lexan 1/4" Universal Spine Insert Screens 112
 PET Universal Spine Insert Screens 113

ELECTRICAL AND DATA

Duplex Outlets 115
 Data Plate Kits 117
 Electrical Jumpers 118
 Base In-Feeds, Ceiling In-Feeds, Undermount and End Mount Poles 119
 Pole Extenders, Power Cord Trays and Cable Management Strips 120

POWERBENCH

PowerBench HAT Enclosed Bases 121
PowerBench HAT Worksurfaces 122

ACCESSORIES

Plug-In Power Solutions 123
Monitor Arms 125
Wire Managers and Anti-Fatigue Mats 126
Powerbeam Mini Shelf and Bag Hook 127

WARRANTY & TERMS AND CONDITIONS

For Warranty & Terms and Conditions please visit:
https://www.ais-inc.com/files/Terms_and_Conditions.pdf

Note: Please see Screens Price Lists for PowerBeam specific screens.

Legs, Spine Beam Kits, Spine Beam Connectors and Spine Beam End Panels

SPINE BEAM KITS

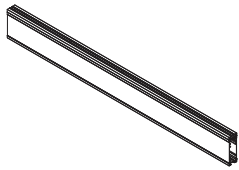

Non-Powered Spine Beam Kits
36" - 96 Wide

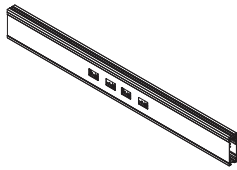

Single Sided Powered Spine Beam Kits
36" - 96 Wide

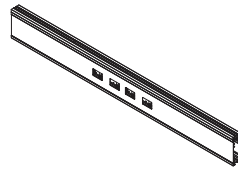

Powered Spine Beam Kits
36" - 96 Wide

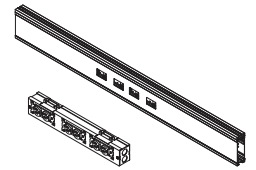

Chicago Powered Spine Beam Kits
36" - 96 Wide

LEGS FOR SPINE BEAMS

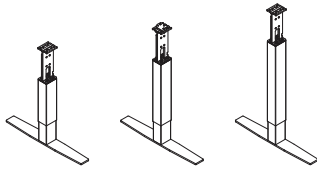

T-Legs
For 21", 25" or 29" High Spine Beams

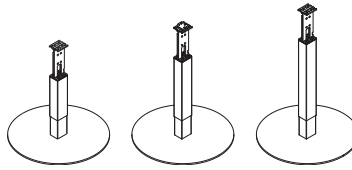

Disc Legs
For 21", 25" or 29" High Spine Beams

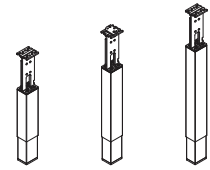

Post Legs
For 21", 25" or 29" High Spine Beams

SPINE BEAM CONNECTORS

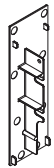

Endcap

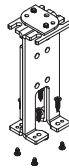

Vertical Support for Storage

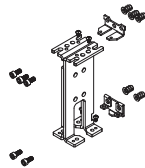

Flush Mount Connection Kit

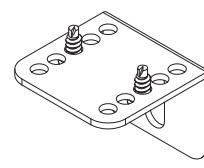

Beam Wall Anchor Bracket

DAY-TO-DAY EXTENDED GALLERY PANELS

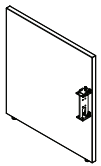

Beam Mount Laminate Gallery Panels

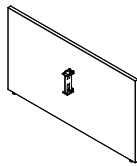

Beam Mount, Double Laminate Gallery Panels

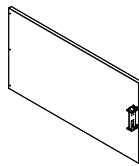

Beam Mount for Wing Laminate Gallery Panels

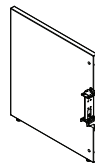

Mid Mount Laminate Gallery Panels

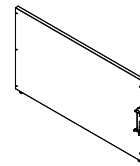

Mid Mount End for Wing Laminate Gallery Panels

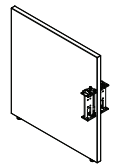

Beam Mount Spine Laminate Gallery Panels

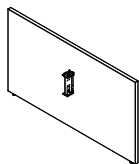

Beam Mount Spine, Double Laminate Gallery Panels

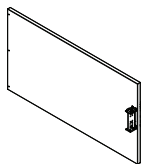

Beam Mount End for Wing Laminate Gallery Panels

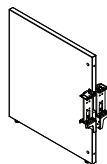

Mid Mount Spine Laminate Gallery Panels

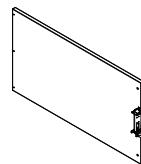

Mid Mount Spine for Wing Laminate Gallery Panels



Laminate Gallery Wing Panels

Spine Screens, Electrical and Data, and Benching Tables

ELECTRICAL AND DATA

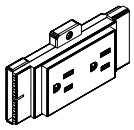

Duplex Outlet

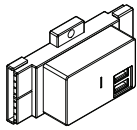

USB Outlet

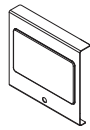

Powerbeam Outlet Cover

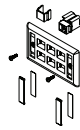

Data Plate Kits

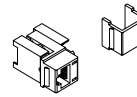

Data Plate Kit

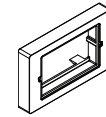

Single Gang Plate Adapter



Electrical Jumper



Ceiling In-Feed

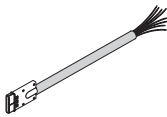

Side-Mounted Base In-Feed



Undermount Poles
For 21", 25" or 29" High



End Mount Poles
For 21", 25" or 29" High

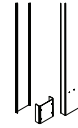

Power/Data Pole Extender



Cord Trays



Cable Management Strip

BENCHING TABLES

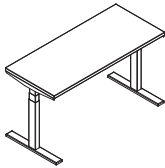

Day-to-Day Rectangular Benching Tables with Height Adjustable Bases

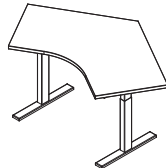

Day-to-Day 120° Corner Benching Tables with Height Adjustable Bases

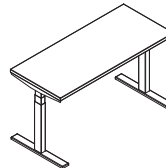

E Series Rectangular Benching Tables with Height Adjustable Bases

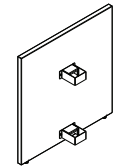

End Panels for Day-to-Day and E Series Benching Tables with Height Adjustable Bases

POWERBENCH

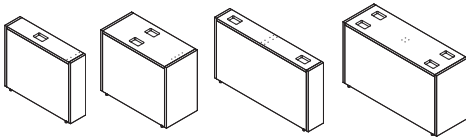

PowerBench HAT Laminate Enclosed Bases
Single End, Single Shared, Double End or Double Shared

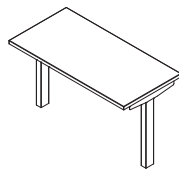

PowerBench HAT Benching Depth Worksurfaces
22 or 28" Deep

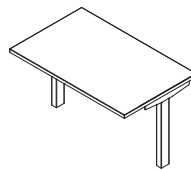

PowerBench HAT Standard Depth Worksurfaces
23 or 29" Deep

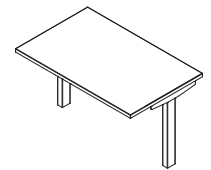
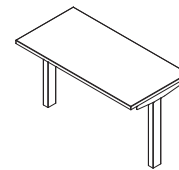

ACCESSORIES

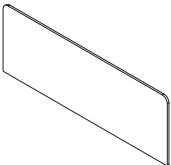

Universal Spine Insert Screen
Glass, Lexan or PET
Glass Shown

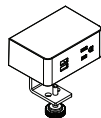

Ashley Uno (Clamp Mount)

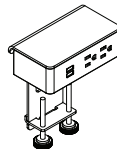

Ashley Duo (Clamp Mount)

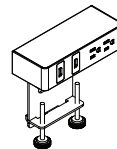

Ashley 202 (Clamp Mount)

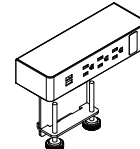

Ashley Trio (Clamp Mount)

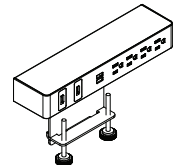

Ashley Quad (Clamp Mount)

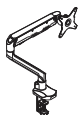

Monitor Arms

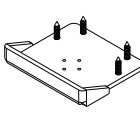

Knife Edge Wedge Bracket

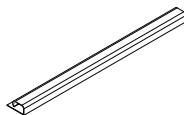
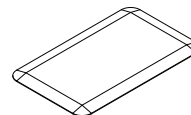

Table Wire Manager



Wire Managers



Anti-Fatigue Mats

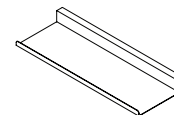

Powerbeam Mini Shelf

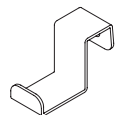

Powerbeam Bag Hook

Tackboard Fabric Options

VERTICAL SURFACE FABRICS

Name	Grade
Amaze	A
Avenue	A
Cape Cod	A
Engage	A
Mirador	A
New England	A
Rainfall	A
Simplicity	A
Theory	A
Twizzle	A
Lido	B
Marin	B
Nature	B
Off the Grid	B
Purpose	B
Spinel	B
Sprite	B

Note: 66" & 72" wide screens – if applying directional fabrics they will need to be railroaded for application. If using a COM fabric that is 54" wide, any screen over 48" wide would need to have the fabric railroaded as well.

C.O.M. Fabric Policy

- It is mandatory that you work directly with your AIS Customer Service Representative for all COM related testing and orders. They will provide all necessary forms to you, as well as work with you with regard to sending in correct yardage and where to send it, along with necessary RA# or #s. Please note an RA must be submitted along with the fabric for testing, as well as an RA created for an actual order.
- **Please Note:** A three to five yard sample is required for testing and approval for use on all monolithic panel systems. A one yard sample is required for testing and approval on Divi Insert Tiles, Matrix Tiles, flipper doors and tackboards. We may be able to test upholstery fabrics with a swatch, your Customer Service Representative will advise based on the fabric being tested; otherwise a 1 yard sample must be submitted for testing. Results take 48 - 72 hours.
- Customer Service must be advised as to the width of the fabric rolls being supplied (54"W or 60"W). Customer Service must also be advised if the fabric has a backer.
- Yardage required for the job must be calculated by an AIS Customer Service Rep.
- Once AIS has approved the COM fabric, a fabric sample needs to be marked by the dealer with "Front", "Top", and "Bottom", to be sure fabric is applied correctly. The fabric sample then needs to be attached to a COM Fabric Dealer Form and forwarded to AIS Customer Service. [The COM Fabric Dealer Form may be downloaded or printed here.](#)
- Fabrics may be discontinued or obsolete without notice.
- Contact AIS Customer Service with any questions regarding fabric availability.
- All directional fabric will be railroaded.

PowerBeam Paint, Edgeband and Tempered Glass Options

POWERBEAM PAINT OPTIONS

Name	Color Code	Grade
Black	BK	A
Chalk	CK	A
Dark Tone	DT	A
Grey Value 1	GV1	A
Innertone	HT	A
Light Tone	LT	A
Medium Tone	MT	A
Metallic Silver	MS	A
Satin White	SW	A
Warm Brown	WB	A
Champagne Metallic	CHM	B
Dark Grey Metallic	DGM	B
Flint Grey Metallic	FGM	B
Light Grey	LG	B
Tan Value 1	TV1	B
Antique Gold	AG	C
Graphite Sky	GS	C
Burnt Orange	BO	C
Brown	BR	C
Steel Blue	SB	C
Baltic Blue	BB	C
Ruby Red	RR	C
Kelly Green	KG	C

Custom Paints

- Minimum order size for any custom color is \$75,000 list. Extended lead-time will apply.
- Any color not shown on Quick Ship, Standard Grade A, B or C will be considered custom.
- A \$450 net paint match fee will be assessed following receipt of (2) 5"x5" samples of paint being matched.
- Minimum order size for any custom color is \$75,000.00 list. Extended lead-time will apply.
- Additionally, Grade C paint up-charges will be applied to all applicable products on the order.
- **Important Custom Paint Note:** Most paint match pricing can be covered by the Grade C up-charge in the catalog, however the final pricing can only be determined after the paint is matched and a product list is provided to AIS customer service. An additional fee may apply based on job size and paint color.

TEMPERED GLASS OPTIONS

Name	3/8" Thick Frameless Glass
Bronze Tint	Y
Clear	Y
Frosted	Y
Grey Tint	Y

All glass is tempered. The etched side of Frosted and Aquis is only on one side of a screen, the opposite side is smooth. Please see specific price list pages on each type of glass for list pricing and up-charges.

EDGEBOARD OPTIONS

Name	Color Code	Grade
Absolute Acajou	AA	A
Aimtoo Savatre	AS	A
Black	BK	A
Brazilwood	BZ	A
Chalk	CK	A
Corporate Walnut	CT	A
Dark Rum Cherry	DR	A
Dark Tone	DT	A
Field Elm	FE	A
Grand Cherry	GC	A
Grey Elm	GE	A
Grey Value 1	GV1	A
Landmark	LM	A
Leave Likatre	LV	A
Light Tone	LT	A
Linen	LN	A
Looks Likatre	LK	A
Maritime Dune	MD	A
Medium Tone	MT	A
Midwest Maple	MM	A
Neo Walnut	NW	A
Phantom Ecrú	PE	A
Phantom Pearl	PP	A
Satin White / True White	SW / TW	A
Storm	ST	A
Summer Drops	SD	A
Trytoo Savatre	TS	A
White Chocolate	WC	A

Custom Edgeband Options

- A \$450 net edge match fee will be assessed to custom match non-standard edgeband.
- Minimum order size for any custom color is \$75,000.00 list. Extended lead-time will apply.

PowerBeam Worksurface Laminate Options

WORKSURFACE LAMINATE OPTIONS	
Name	Grade
Absolute Acajou*	A
Aimtoo Savatre*	A
Black*	A
Brazilwood*	A
Chalk*	A
Corporate Walnut*	A
Dark Rum Cherry*	A
Field Elm	A
Grand Cherry*	A
Grey Elm	A
Landmark	A
Leave Likatre*	A
Linen	A
Looks Likatre*	A
Maritime Dune*	A
Midwest Maple*	A
Neo Walnut	A
Phantom Ecru	A
Phantom Pearl	A
Storm*	A
Summer Drops*	A
True White*	A
Trytoo Savatre*	A
White Chocolate*	A
Asian Night	B
Asian Sand	B
Beige Granite	B
Colombian Walnut	B

WORKSURFACE LAMINATE OPTIONS	
Name	Grade
Fonthill Pear	B
Grey Mesh	B
Gridlock in L.A.	B
Madagascar	B
Mahogany Clove	B
Monticello Maple	B
Nightfall	B
Paris White Potteryware	B
Pewter Mesh	B
Recon Oak	B
Shadow	B
Sunset	B
Titanium EV	B
Tungsten EV	B
White Spektrum	B
Windswept Poweter	B
Yorkshire Cherry	B
Ebony	C
Bright White (Writable Surface)	C
Pecan Woodline	C
Strand Burnt	C
Strand Wedge	C
Strand Wheat	C
Twill Earthen	C
Twill Graphite	C
Twill Sarum	C
Warm White	C

*Indicates a Grade A finish that can be used on Casegood body/case/door/drawer.

Typical 1

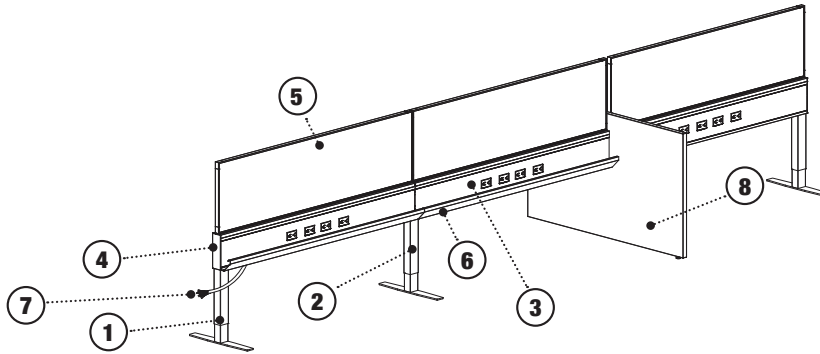

Description	Model Number	Quantity	Notes
1. T-Legs for 25" High Spine Beams	T-BTLEG2518	2x	Used at end of beam.
2. T-Legs for 25" High Spine Beams	T-BTLEG2518	1x	Shared between two Beam sections.
3. 60" Wide Powered Spine Beam	T-BP60	1x	Outlets ordered separately.
4. Beam Endcap	T-BREC	2x	Order separately. Not needed with end panels.
5. 16" High x 60" Wide Tackable or Whiteboard Fixed Height Screen	O-SSH1660	2x	16" high screen on 25" high Beam = 42" horizon.
6. 60" Wide Power Cord Tray	T-BPCT60	2x	Order separately.
7. Side Mount Base In-feed	E-UN8W4BIFS	1x	Order undermount pole separately if desired.
8. 48" Wide x 29" High Laminate Gallery Panel for 25" High Mounts	T-BLGP294825	1x	Shared between two Beam sections.

Typical 2

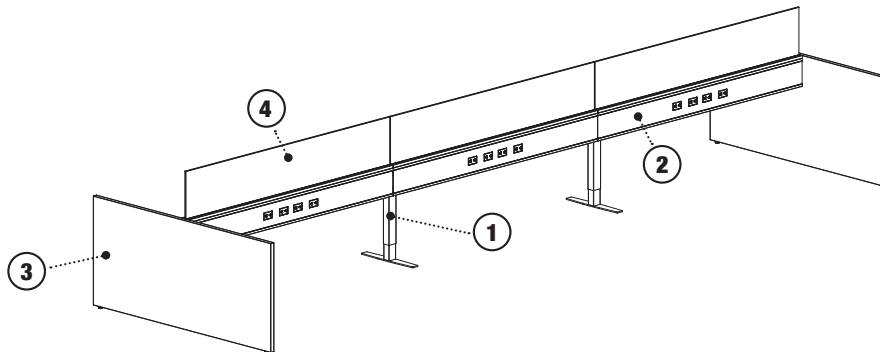

Description	Model Number	Quantity	Notes
1. T-Legs for 29" High Spine Beams	T-BTLEG2918	2x	Shared between two Beam sections.
2. 60" Wide Powered Spine Beam	T-BP60	3x	Outlets ordered separately.
3. 60" Wide x 29" High Double End Panel for 29" High Beam Mount	T-BLEP2960	2x	Endcaps not required when using end panels.
4. 12" High x 60" Wide Fixed Height Glass Spine Screen	O-SGH1260	3x	Glass can only be used on Beams that are attached to end panels, storage elements or 2, 3, or 4-way connections.

PowerBeam Typicals

Typical 3

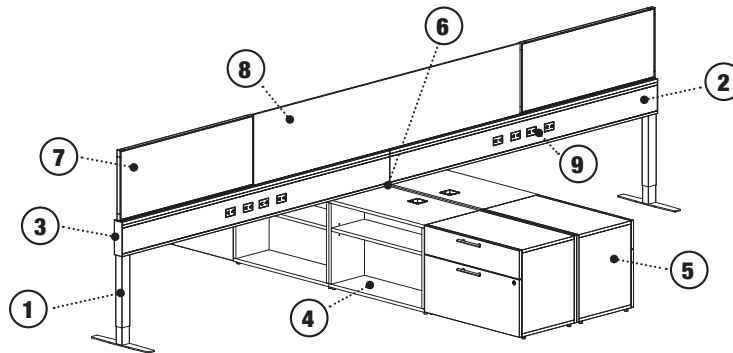

Description	Model Number	Quantity	Notes
1. T-Legs for 29" High Spine Beams	T-BTLEG2918	2x	Used at end of beam.
2. 72" Wide Powered Spine Beam	T-BP72	2x	Outlets ordered separately.
3. Beam Endcap	T-BREC	2x	Order separately. Not needed with end panels.
4. 18" Deep x 30" Wide x 21" High Calibrate HAT Base with Bookcase	X-HBBC3018	4x	From Calibrate line. Must support end of beam.
5. 30" Wide x 18" Deep x 21" High Calibrate BF Lateral	X-PLAT2D3018	4x	From Calibrate line.
6. Vertical Support for Storage Mounted Beam	T-BVS	1x	Specified when a leg support is replaced by storage element.
7. 16" High x 36" Wide Tackable or Whiteboard Fixed Height Screen	O-SSH1636	2x	16" high screen on 29" high Beam = 46" horizon.
8. 16" High x 72" Wide Fixed Height Glass	O-SGH1672	1x	Glass can only be used on Beams that are attached to end panels, storage elements or 2, 3, or 4-way connections.

Typical 4

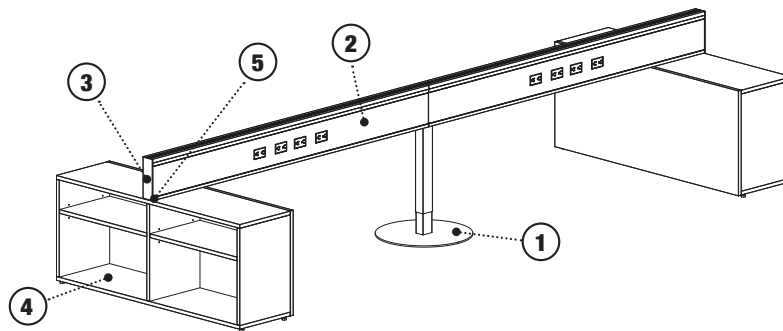

Description	Model Number	Quantity	Notes
1. Disc Leg for 29" High Spine Beams	T-BDLEG2918	1x	Shared between two Beam sections.
2. 60" Wide Powered Spine Beam	T-BP60	2x	Outlets ordered separately.
3. Beam Endcap	T-BREC	2x	Order separately. Not needed with end panels.
4. 14" Deep x 48" Wide x 21" High Calibrate Bookcase	X-BC204814	2x	From Calibrate line.
5. Vertical Support for Storage Mounted Beam	T-BVS	2x	Specified when a leg support is replaced by storage element.

Typical 5

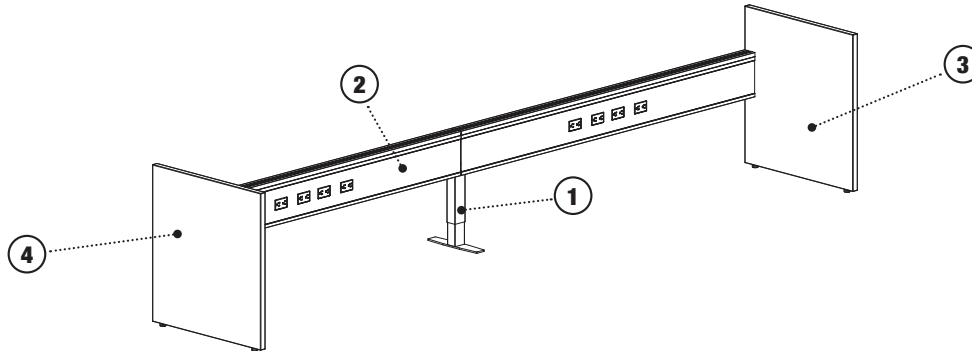

Description	Model Number	Quantity	Notes
1. T-Legs for 25" High Spine Beams	T-BTLEG2518	1x	Shared between two Beam sections.
2. 60" Wide Powered Spine Beam	T-BP60	2x	Outlets ordered separately.
3. 30" Deep x 29" High Right End Panel for 25" High Beam Mount	T-BLEP292425R	1x	Endcaps not required when using end panels.
4. 30" Deep x 29" High Left End Panel for 25" High Beam Mount	T-BLEP292425L	1x	Endcaps not required when using end panels.

Typical 6

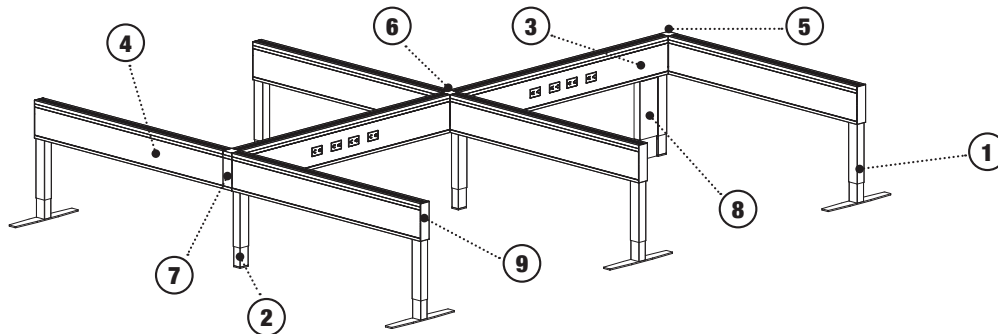

Description	Model Number	Quantity	Note
1. T-Legs for 25" High Spine Beams	T-BTLEG25	5x	Used at end of beam.
2. Post Legs for 25" High Spine Beams	T-BPLEG25	3x	Used only when connected to a 2, 3 or 4-way 90 or 120 degree connector.
3. 48" Wide Powered Spine Beam	T-BP48	2x	Outlets ordered separately.
4. 48" Wide Non-Powered Spine Beam	T-BNP48	5x	Used for running data or electrical pass-through cables, attaching accessories or screens.
5. 2-Way 90° Connection Kit	T-B2W90C	1x	Specify when attaching 2-beams together at 90 degree angles. Specify leg support separately.
6. 4-Way 90° Connection Kit	T-B4W90C	1x	Specify when attaching 4-beams together at 90 degree angles. Specify leg support separately.
7. 3-Way 90° Connection Kit	T-B3W90C	1x	Specify when attaching 3-beams together at 90 degree angles. Specify leg support separately.
8. Undermount Pole for 25" High Spine Beams	T-BUMP25	1x	Pole can be mounted at either end of any beam section.
9. Beam Endcap	T-BREC	5x	Order separately. Not needed with end panels.

PowerBeam Typical

Typical 7

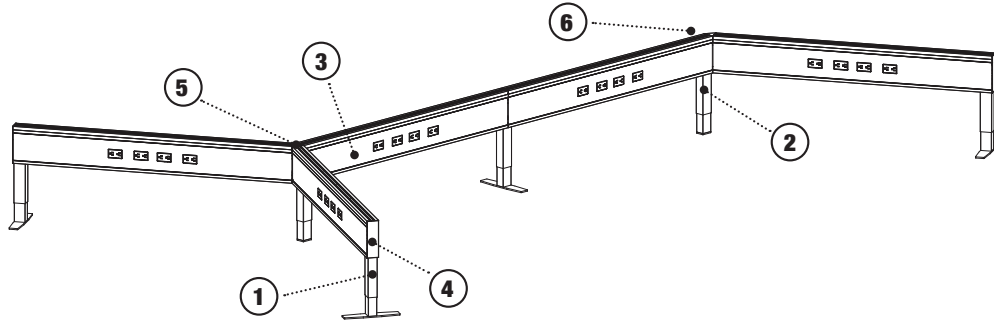

Description	Model Number	Quantity	Notes
1. T-Legs for 21" High Spine Beams	T-BTLEG2112	4x	Used at end of beam.
2. Post Legs for 21" High Spine Beams	T-BPLEG21	2x	Used only when connected to a 2, 3 or 4-way 90 or 120 degree connector.
3. 60" Wide Powered Spine Beam	T-BP60	5x	Outlets ordered separately.
4. Beam Endcap	T-BREC	3x	Ordered separately. Not needed with end panels.
5. 3-Way 120° Connection Kit	T-B3W120C	1x	Specify when attaching 3-beams together at 120 degree angles. Specify leg support separately.
6. 2-Way 120° Connection Kit	T-B2W120C	1x	Specify when attaching 2-beams together at 120 degree angles. Specify leg support separately.

PowerBeam Product Details

Beam Cable Capacity

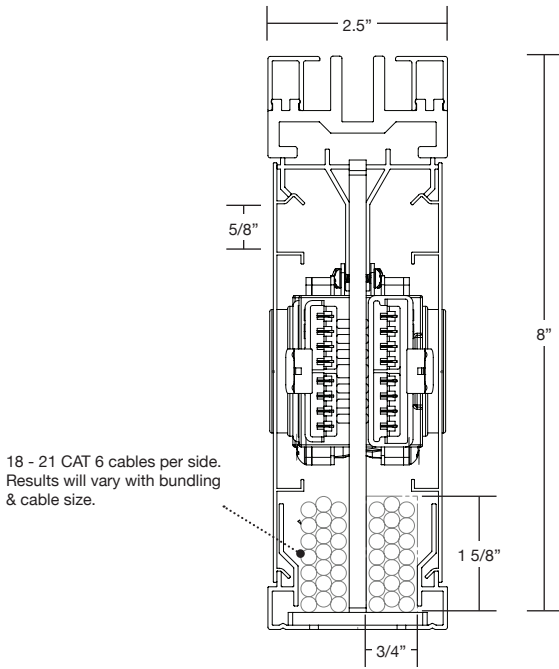

Beam Infeed Opening Details

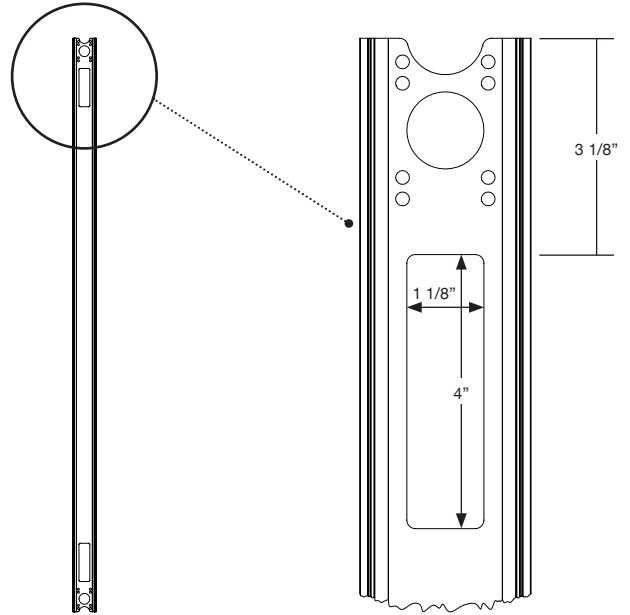

Infeed opening at bottom of beam.

Power Cord Tray Details

Note: optional power tray ordered separately.

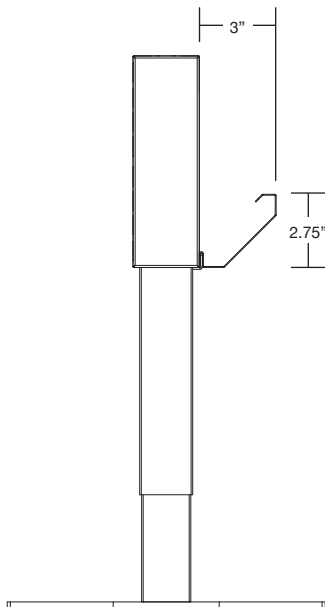

PowerBeam Product Details

Day-to-Day Benching Height Adjustable Table Heights and Depths

E Series Benching Height Adjustable Table Heights and Depths

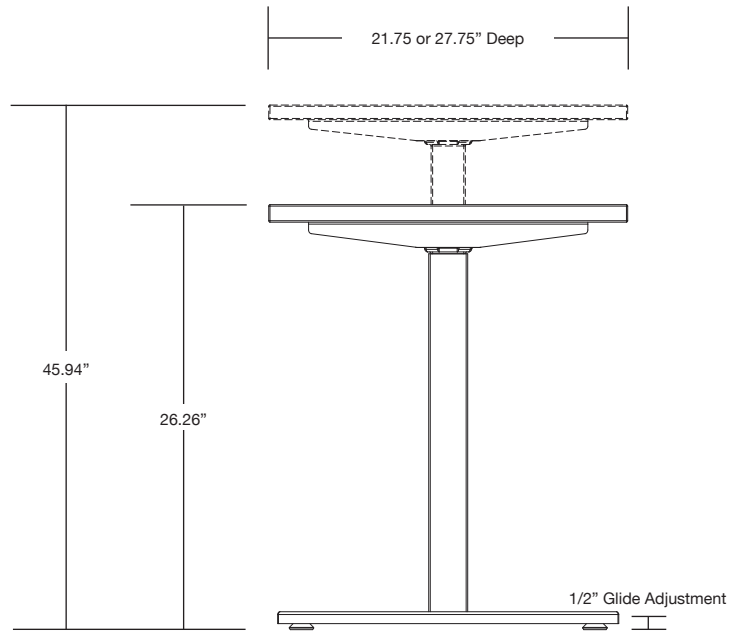
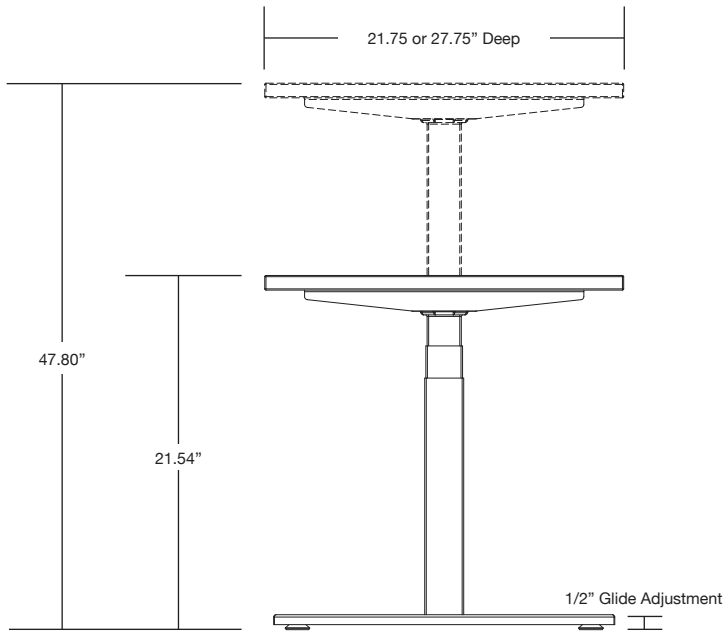

Beam Heights

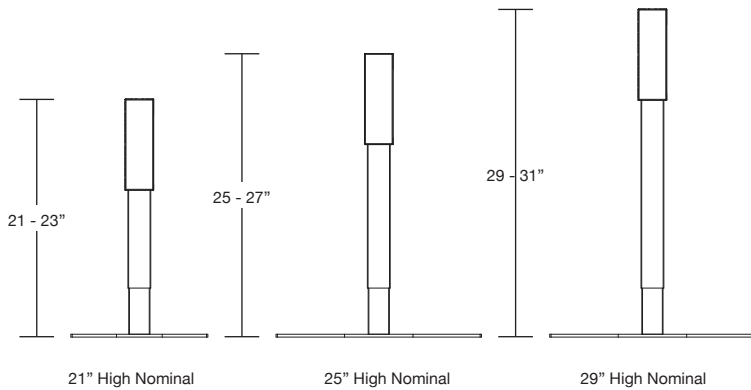

Beam Details

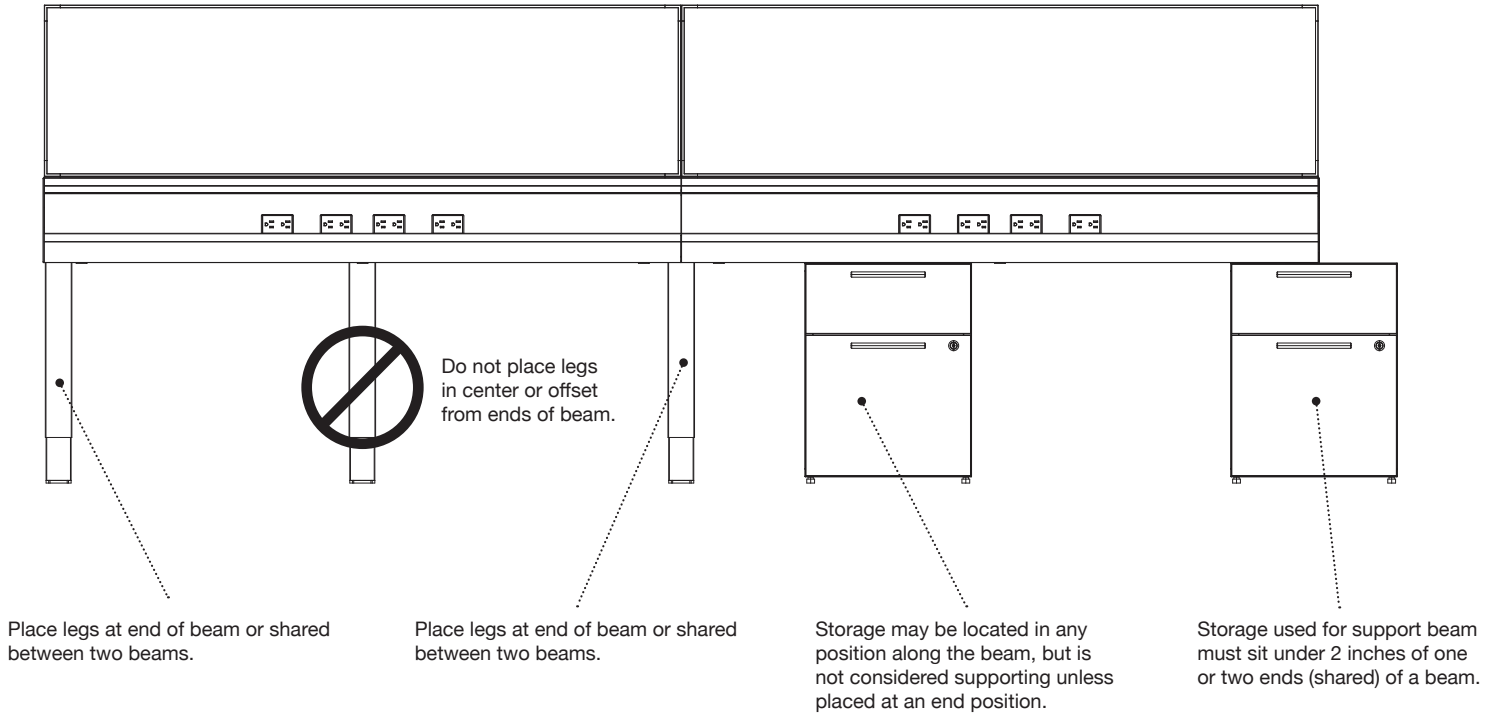

Beam Infeed to Outlet Calculation

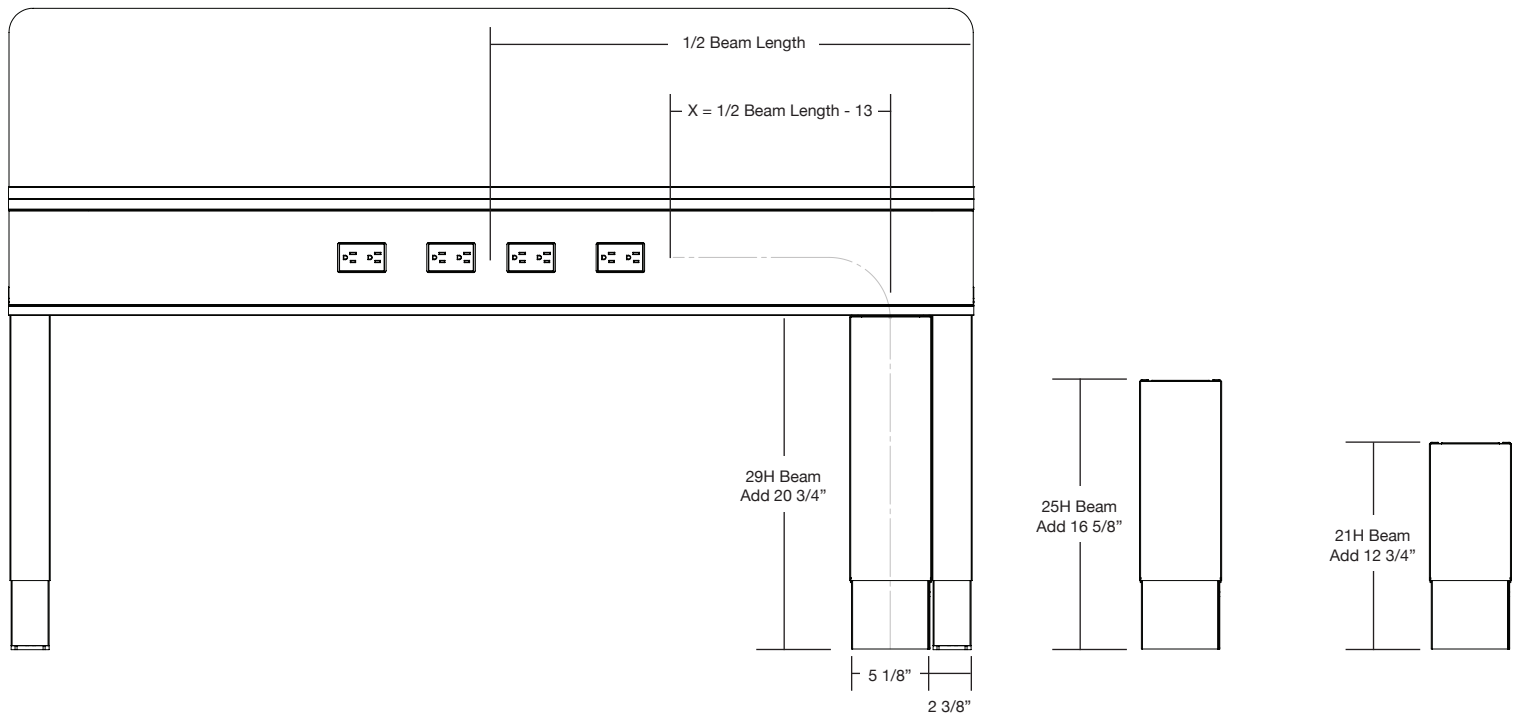

PowerBeam Product Details

Rectangular Benching Table Grommet Options

Option	Location	List
A	No Grommets	-
B	Location 1	+38
C	Location 2	+38
D	Location 3	+38
E	Locations 2 and 3	+76
F	Locations 1, 2 and 3	+114
G	Locations 1 and 2	+76
H	Locations 1 and 3	+76

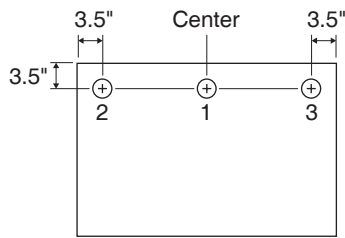

120 Corner Benching Table Grommet Options

Option	Location	List
A	No Grommets	-
B	Location 1 (Default)	-
C	Location 1 and 2	+38
D	Location 1 and 3	+38
E	Locations 1, 2 and 3	+76

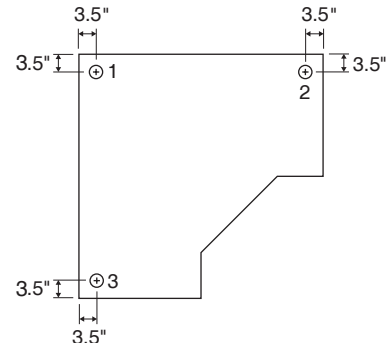

PowerBench Typical

PowerBench Typical 1

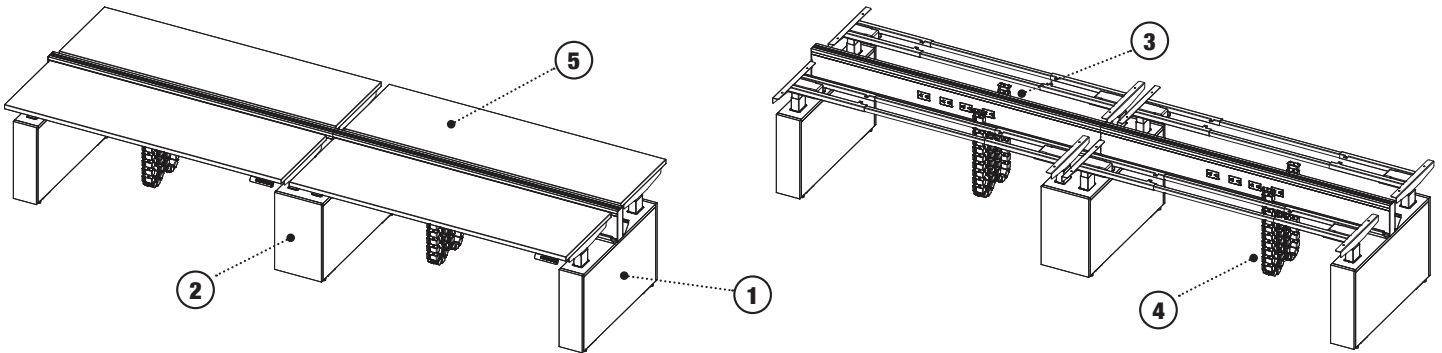

Description	Model Number	Quantity	Notes
1. PowerBench HAT Enclosed Base 36D Double End	T-BBHB36DE	2x	End bases can be used at end of run or in middle of run.
2. PowerBench HAT Enclosed Base 36D Double Shared	T-BBHB36DS	1x	Shared bases are used only in between two benches.
3. PowerBeam Powered Spine Kit 72W	T-BP72	1x	Available with single or double sided power.
4. Desking Vertical Wire Manager	T-TVWM40	4x	Optional
5. PowerBench HAT 2-Leg Square Edge 24D x 72W	PB-2H2472	4x	Order HAT that matches spine nominal width.

PowerBench Typical 2

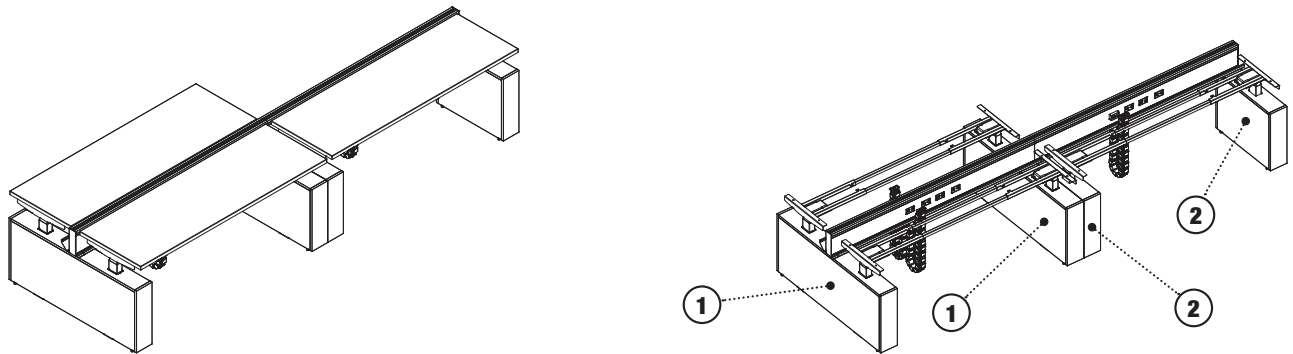

Description	Model Number	Quantity	Notes
1. PowerBench HAT Enclosed Base 48D Double End	T-BBHB48DE	2x	End bases should be used when transitioning from double benches to single benches.
2. PowerBench HAT Enclosed Base 24D Single End	T-BBHB24SE	1x	End bases should be used when transitioning from double benches to single benches.

PowerBench Typicals

PowerBench Typical 3

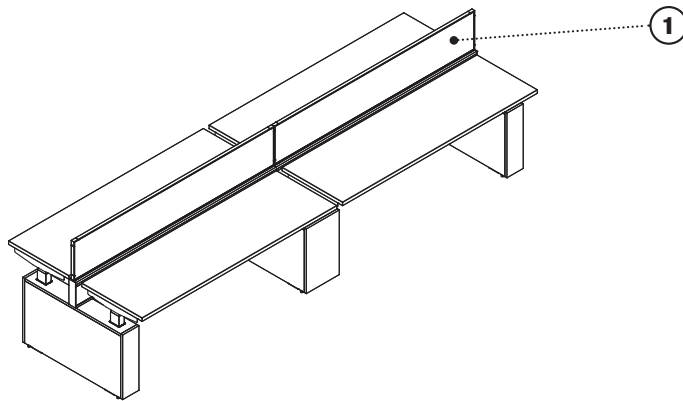

Description	Model Number	Quantity	Notes
1. Slimline Scrn, Uni Spine, FVWL, Dim A, SpnMntUni, 12H x 72W	O-SSH1272	2	For Fixed height screens for PowerBench, choose: Where Used = "Universal Spine" Sized For = "Nominal/Actual" Mount Type = "Universal Spine"

PowerBench Typical 4

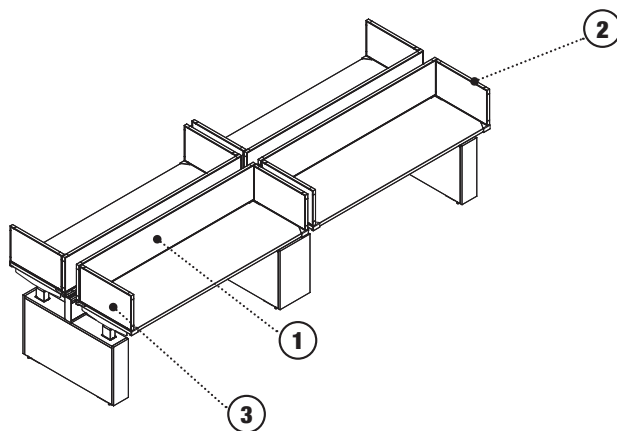

Description	Model Number	Quantity	Notes
1. Slimline Scrn, Frnt-Rr, FVWL, Dim G, UMnt, Uni, 12H x 72W	T-SWMM1272	4	For Height Adjustable Screens on PowerBench back edge, choose: Where Used = "Front/Rear on Worksurface" Sized For = "Day to Day and Calibrate Widths" Mount Type = "Undersurface Mount"
2. Slimline Scrn, Terri, FVWL, Dim D, UMnt, RH, 12H x 24W	T-TSHR1224	4	For Height Adjustable Screens used at side of worksurface choose: Where Used = "Territory on Worksurface" Sized For = "Day to Day and Calibrate Hat Depths" Mount Type = "Undersurface Mount" Handedness = "Right Hand"
3. Slimline Scrn, Terri, FVWL, Dim D, UMnt, LH, 12H x 24W	T-TSHL1224	4	For Height Adjustable Screens used at side of worksurface choose: Where Used = "Territory on Worksurface" Sized For = "Day to Day and Calibrate Hat Depths" Mount Type = "Undersurface Mount" Handedness = "Left Hand"

PowerBench HAT Enclosed Single Bases with HAT Surface Dimensions

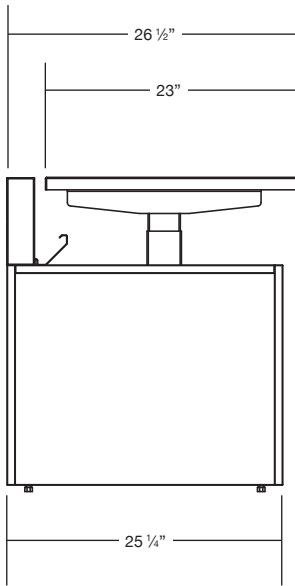

PowerBench
24D Single Sided Enclosed Base
with 24D PowerBench HAT

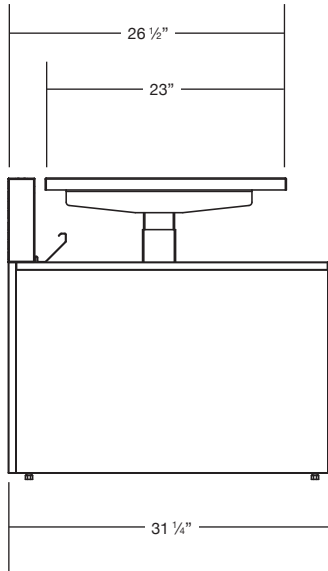

PowerBench
30D Single Sided Enclosed Base
with 24D PowerBench HAT

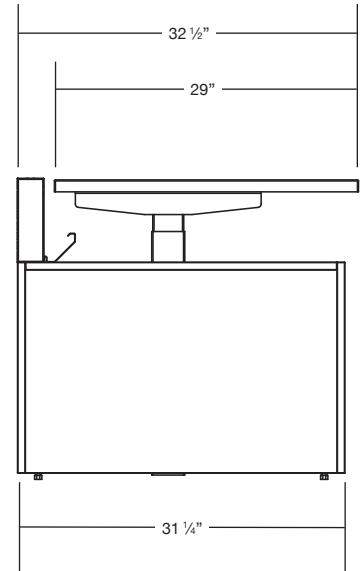

PowerBench
30D Single Sided Enclosed Base
with 30D PowerBench HAT

Important: 30D HAT Surfaces cannot be used with 24D Bases.

PowerBench Product Details

PowerBench HAT Enclosed Double Bases with HAT Surface Dimensions

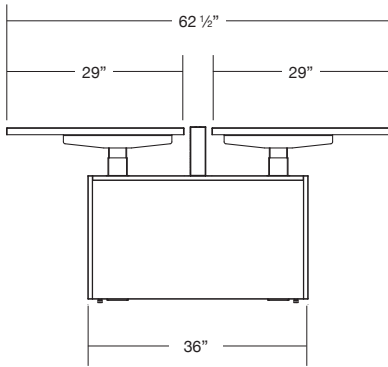

PowerBench
36D Double Enclosed Base with
30D PowerBench HATs

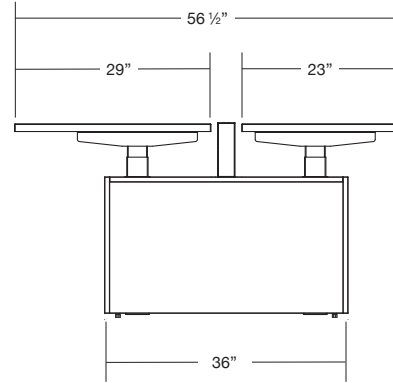

PowerBench
36D Double Enclosed Base
with (1) 30D PowerBench HAT and
(1) 24D PowerBench HAT

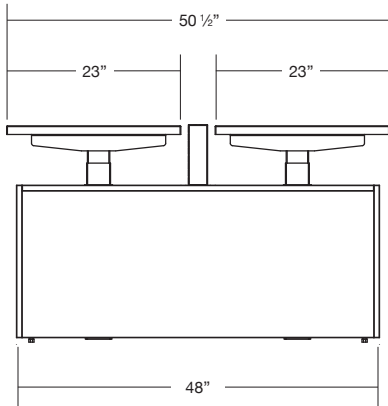

PowerBench
48D Double Enclosed Base with
24D PowerBench HATs

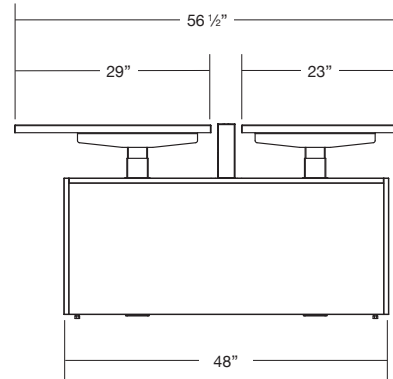

PowerBench
48D Double Enclosed Base
with (1) 30D PowerBench HAT and
(1) 24D PowerBench HAT

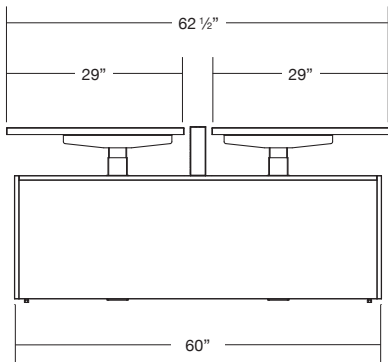

PowerBench
60D Double Enclosed Base with
30D PowerBench HATs

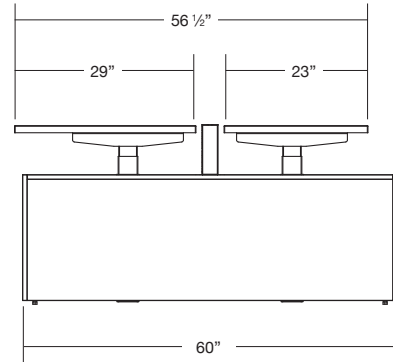

PowerBench
60D Double Enclosed Base
with (1) 30D PowerBench HAT and
(1) 24D PowerBench HAT

PowerBench Grommet Details

Option	Location	List
A	No Grommets	-
B	Location 1	+38
C	Location 2	+38
D	Location 3	+38
E	Locations 2 and 3	+76
F	Locations 1, 2 and 3	+114
G	Locations 1 and 2	+76
H	Locations 1 and 3	+76

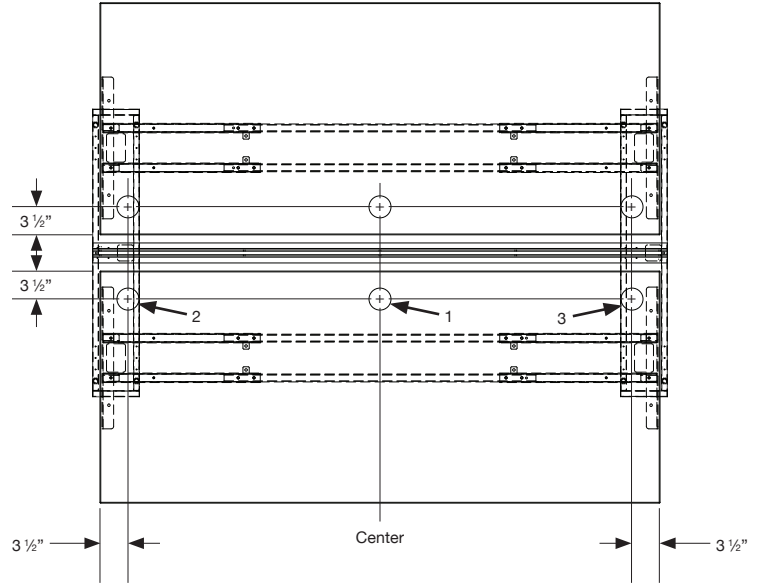

PowerBench Product Details

Powerbench Enclosed Base Power and Data Access Holes

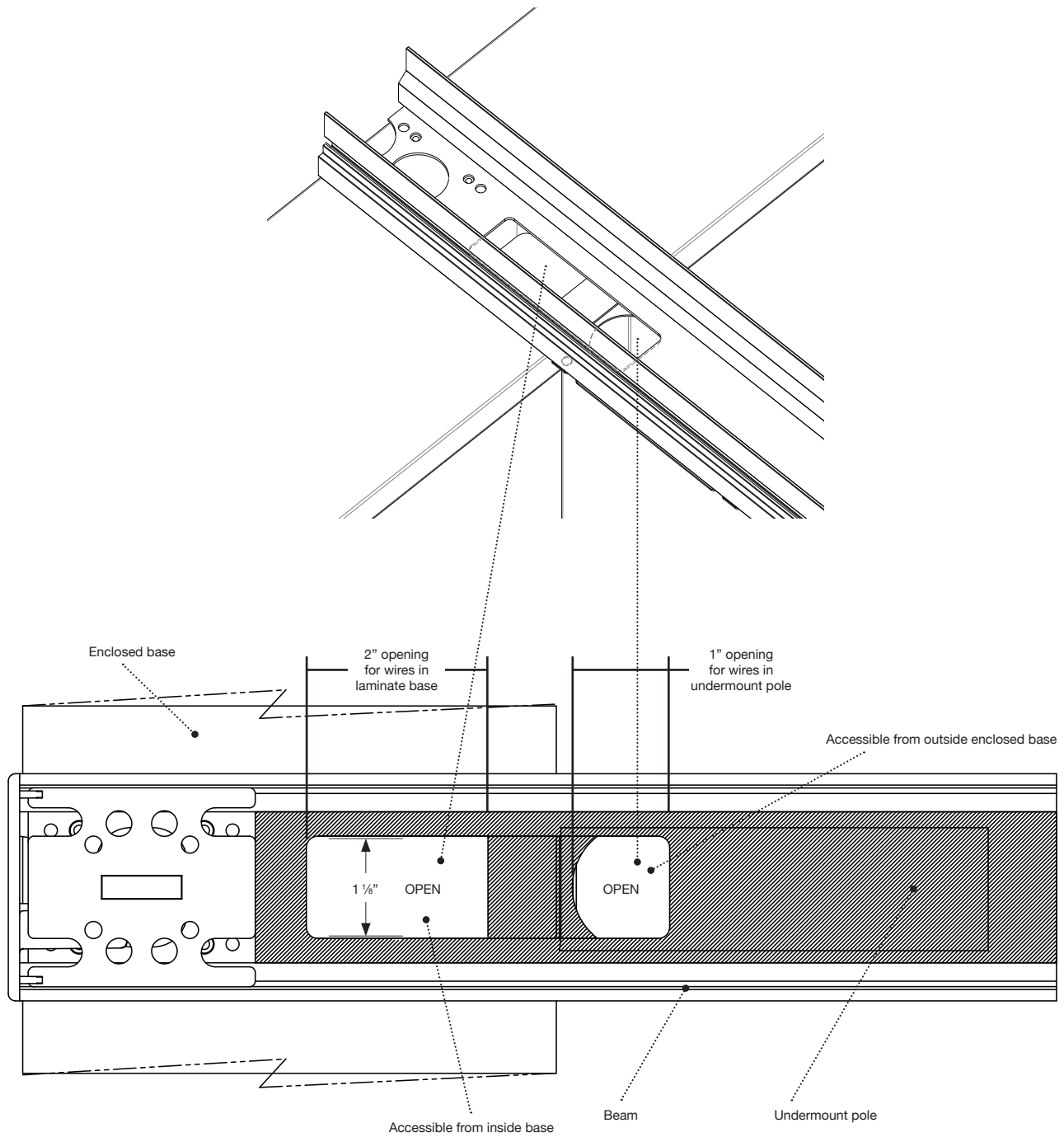

PowerBench Product Details

PowerBench Infeed Details

Base feed entry using Powerbeam Undermount Pole

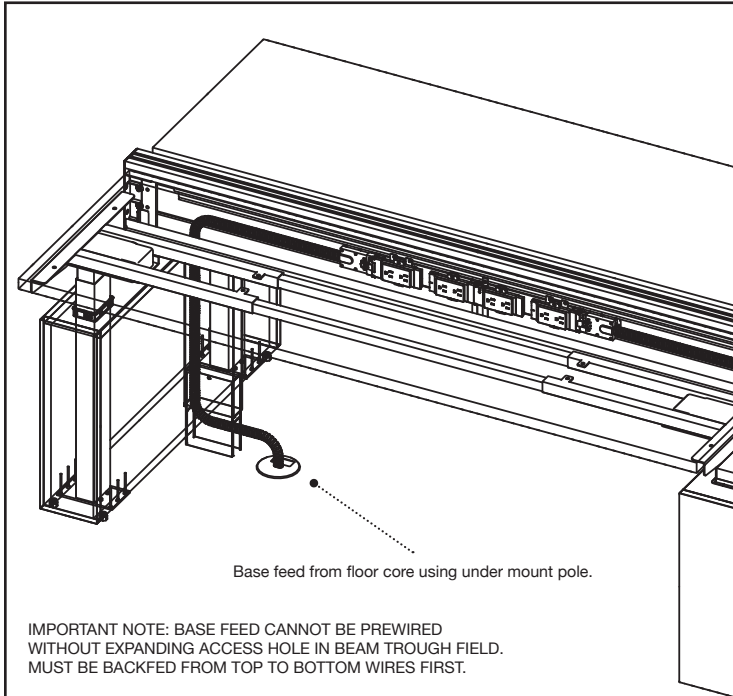

Base Infeed without using Undermount Pole

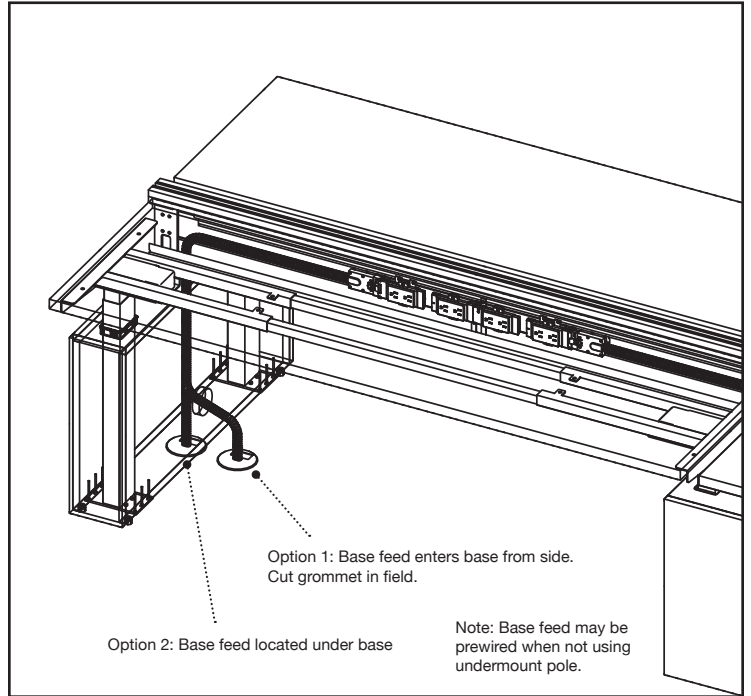

Ceiling Infeed

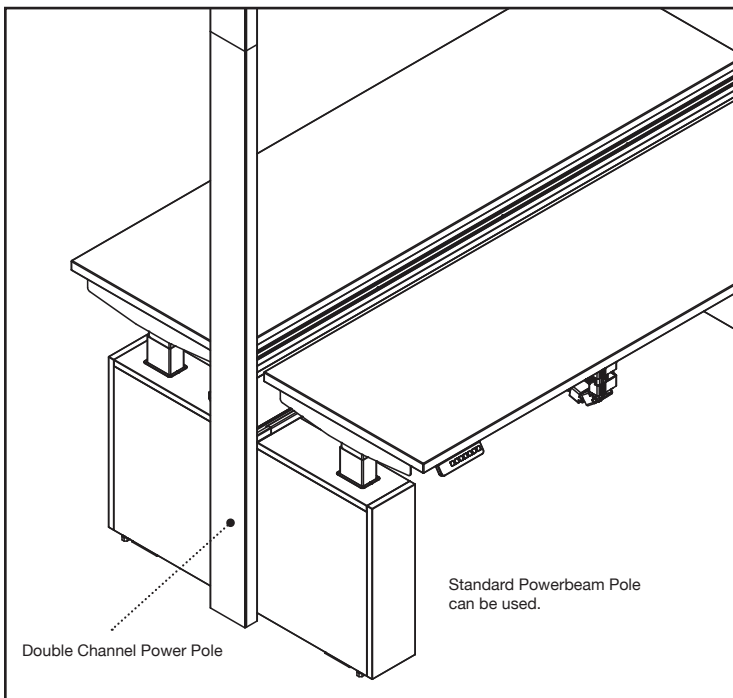

Shared Cabinet Feed Details

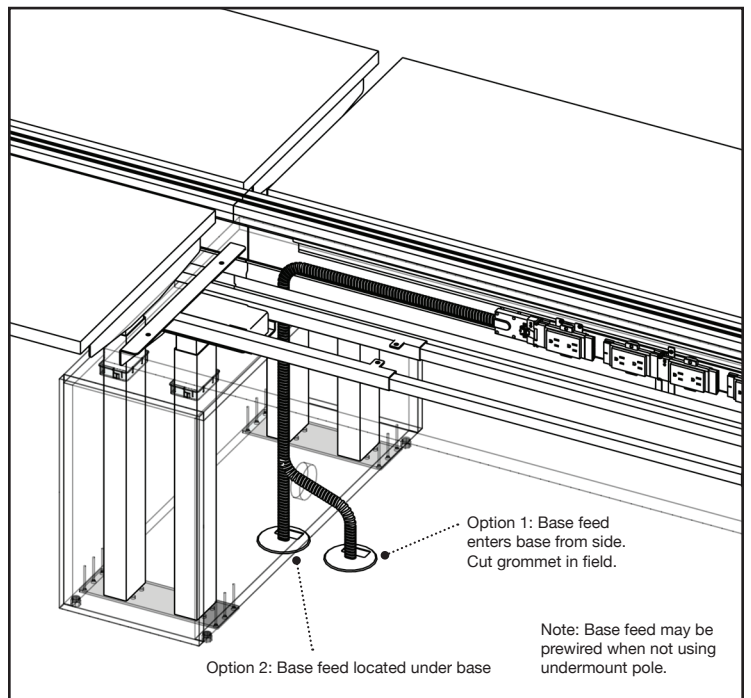

PowerBench Product Details

PowerBench Front Elevation Details

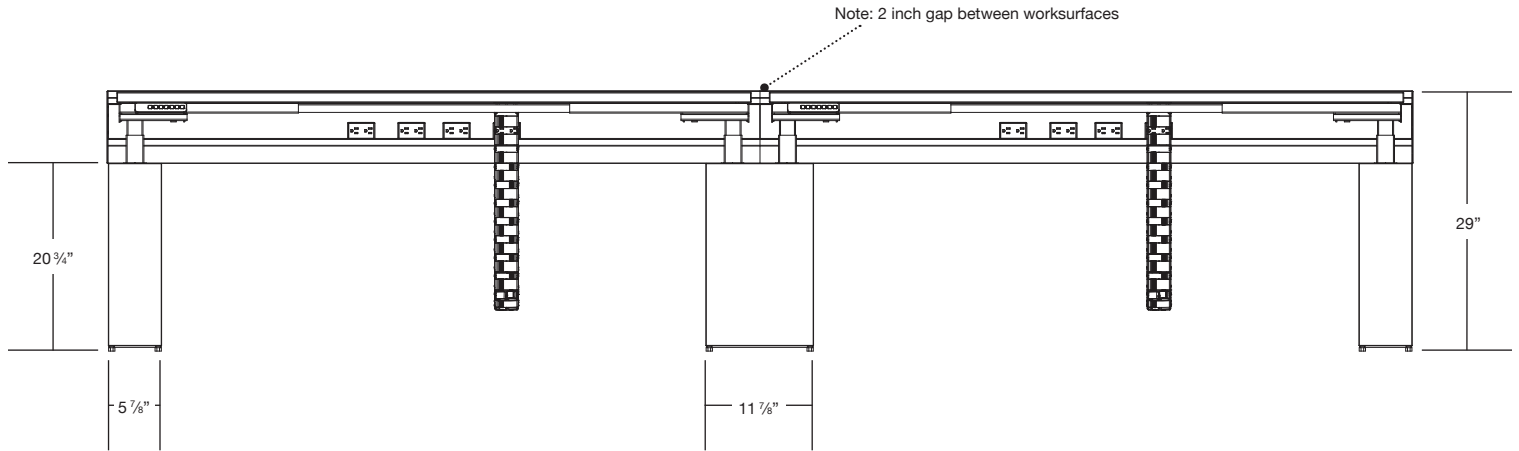

Powerbench Surface Clearance and User Power Cord Tray Details

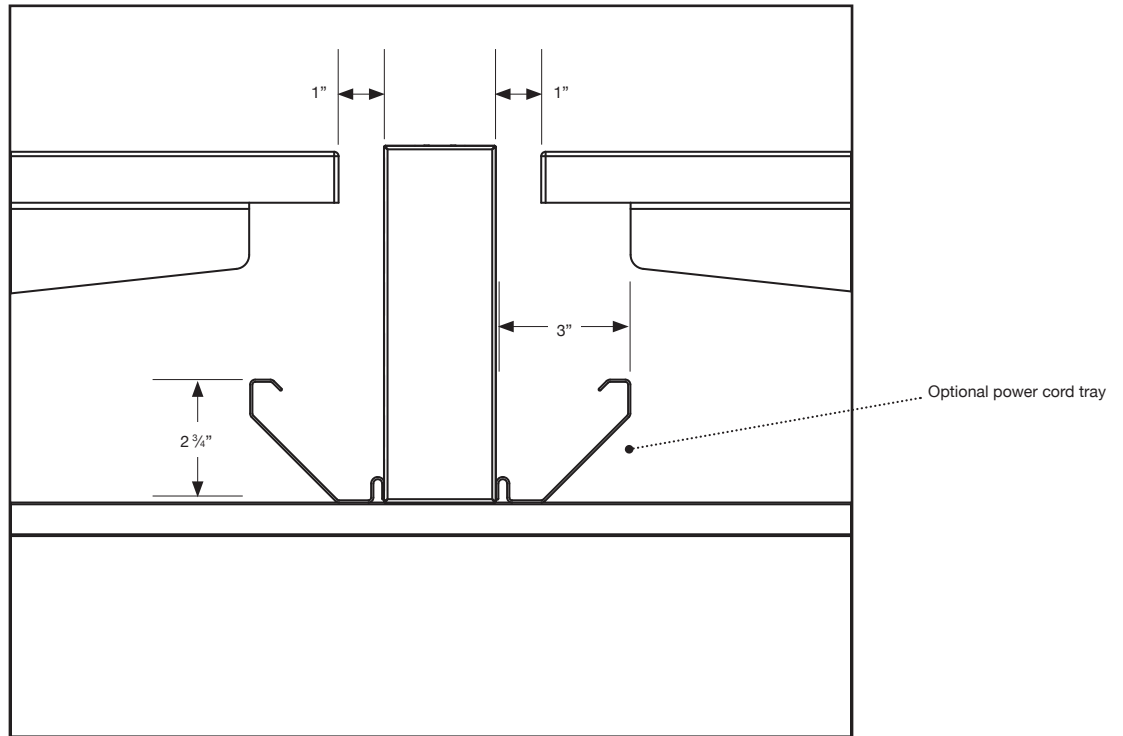

Powerbench Monitor Arm and Clamp Power Mounting Details

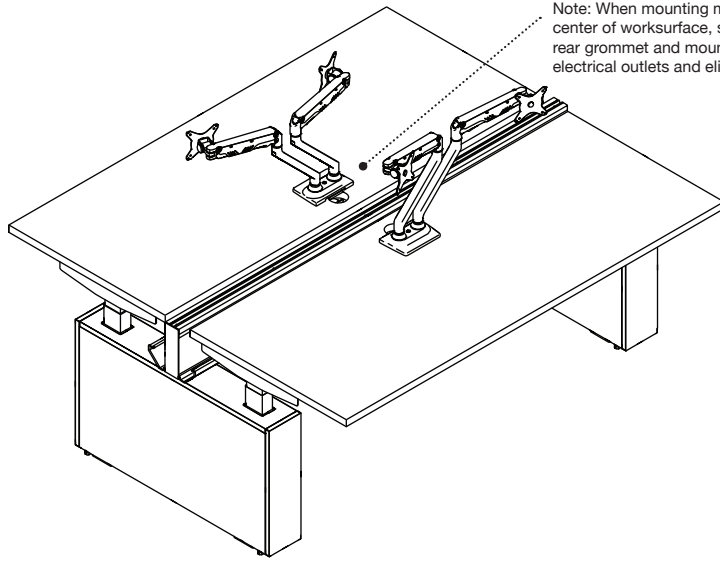

Note: When mounting monitor arms or clamp on power units in center of worksurface, specify grommet option B with a center rear grommet and mount in grommet hole to sit forward of electrical outlets and eliminate interference with plugs and cords.

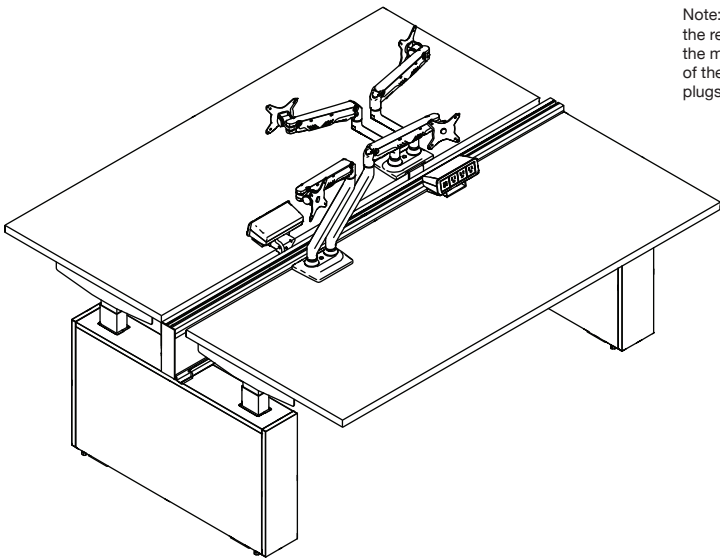

Note: When clamping monitor arms onto the rear edge of the worksurface, install the monitor arm base to left or right side of the outlets to avoid interference with plugs when lowering the unit.

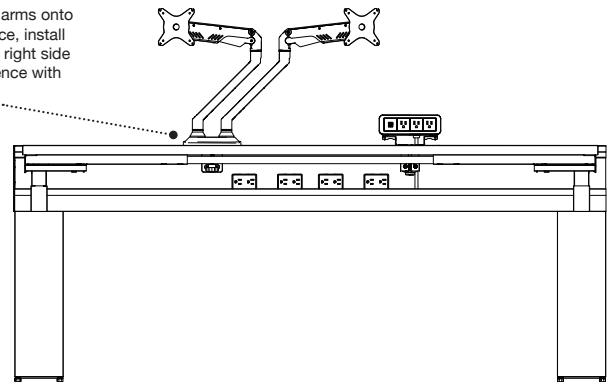

PowerBench Product Details

PowerBench Storage Location Details

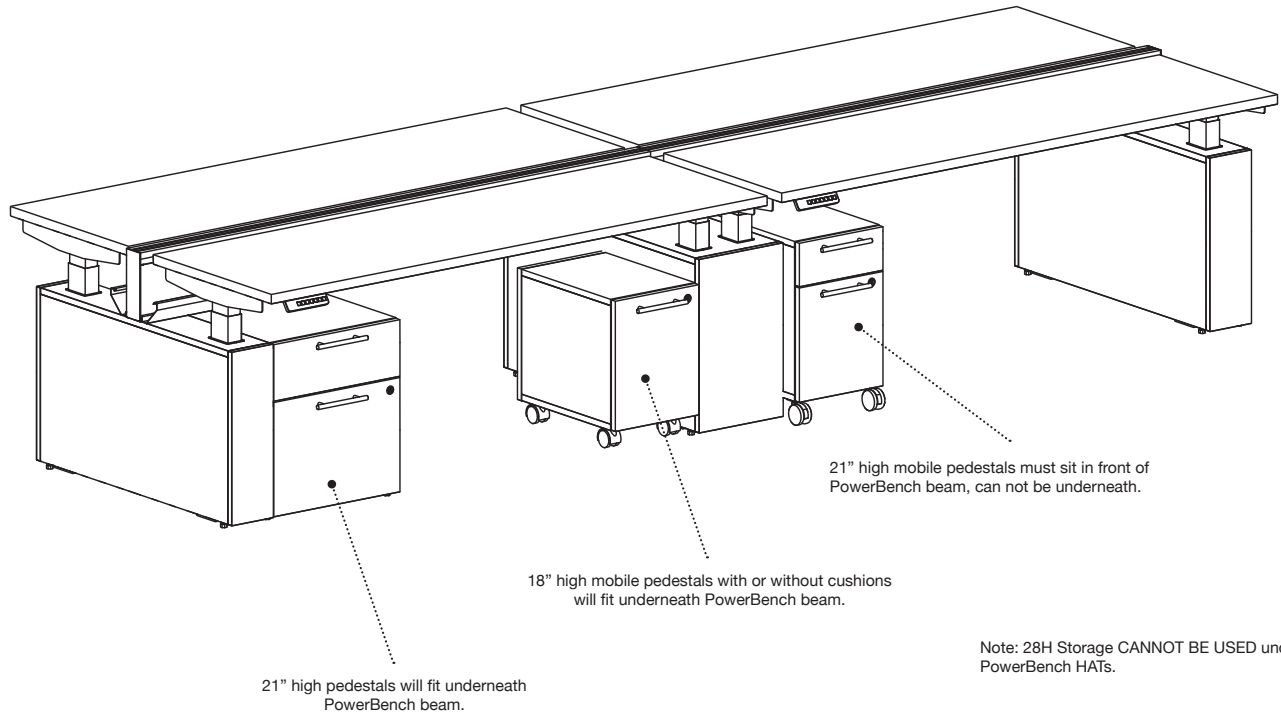

PowerBench Gallery Panel Details

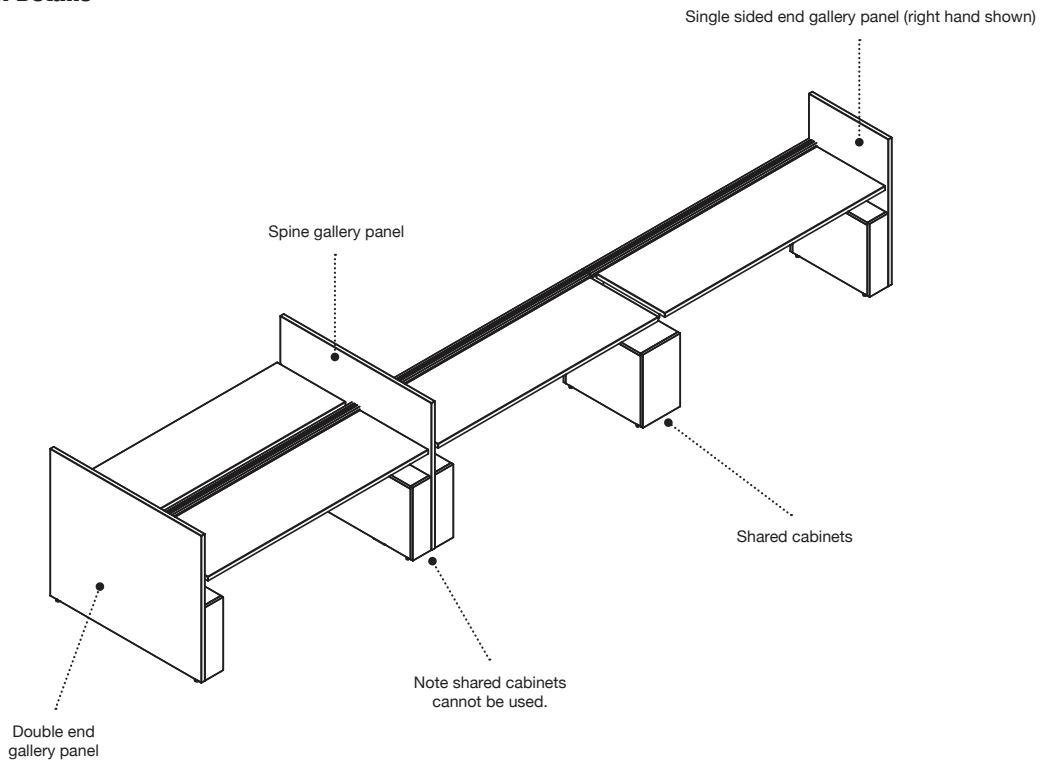

PowerBench with PET Wire Managers Details

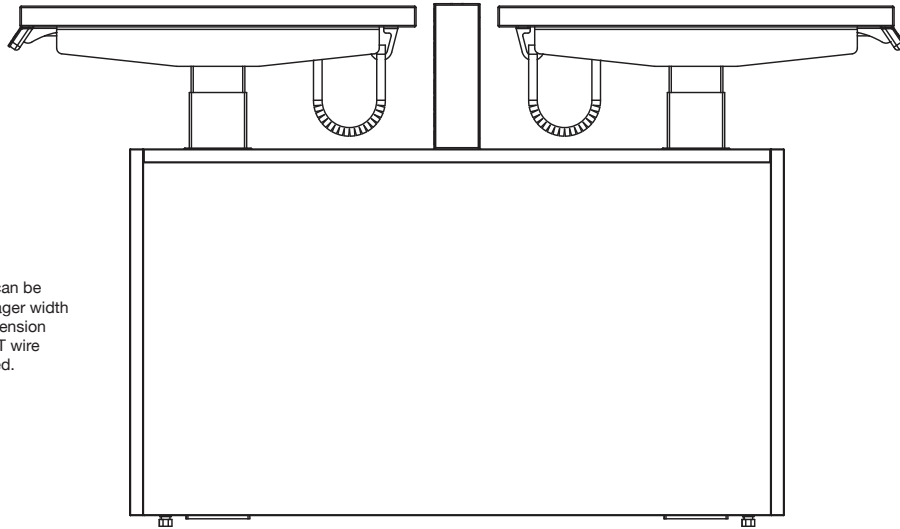

Note: PET Under Mount Wire Managers can be used on Powerbench provided wire manager width is 12 inches less than bench nominal dimension (i.e. use 48w on 60w bench). All other PET wire managers or Enclosures CANNOT be used.

PowerBench with PET Wire Managers Details

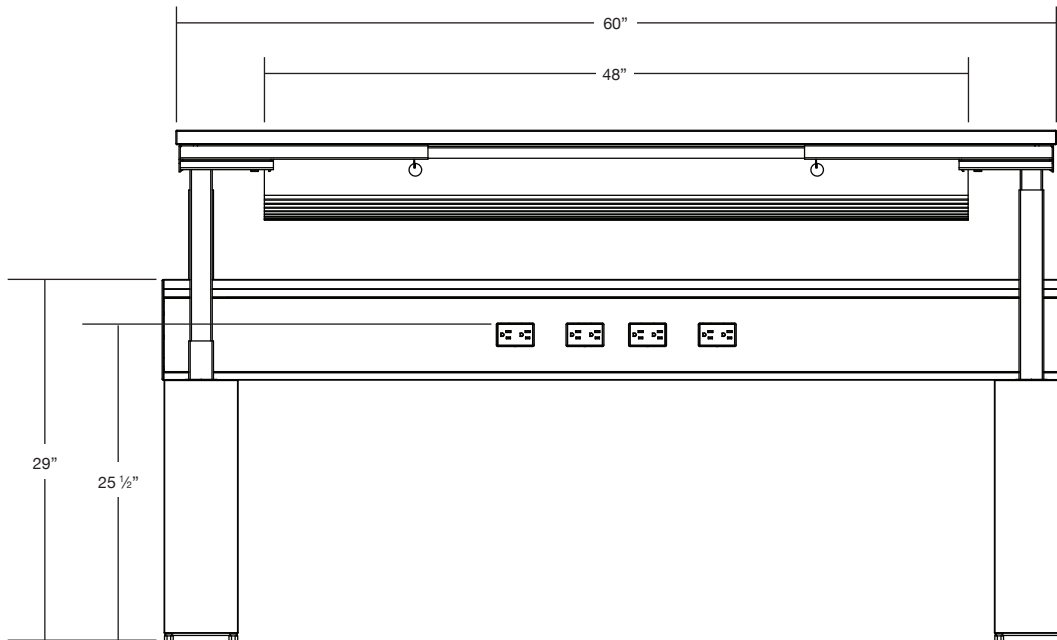

Non-Powered and Single Sided Powered Spine Beam Kits

NON-POWERED SPINE BEAM KITS

W	Model Number	List	Grade C Paint
36	T-BNP36	680	+10
42	T-BNP42	734	+10
48	T-BNP48	786	+10
54	T-BNP54	922	+10
60	T-BNP60	958	+10
66	T-BNP66	1,051	+10
72	T-BNP72	1,128	+10
78	T-BNP78	1,242	+10
84	T-BNP84	1,341	+10
90	T-BNP90	1,414	+10
96	T-BNP96	1,525	+10

SINGLE SIDED POWERED SPINE BEAM KITS

W	Model Number	List	Grade C Paint
36	T-BPSS36	1,176	+10
42	T-BPSS42	1,230	+10
48	T-BPSS48	1,280	+10
54	T-BPSS54	1,419	+10
60	T-BPSS60	1,454	+10
66	T-BPSS66	1,546	+10
72	T-BPSS72	1,623	+10
78	T-BPSS78	1,737	+10
84	T-BPSS84	1,835	+10
90	T-BPSS90	1,935	+10
96	T-BPSS96	2,020	+10

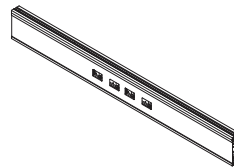
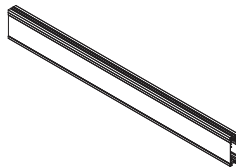

Front View

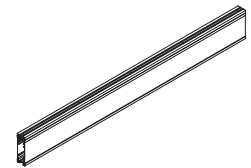

Back View

Specify

- Paint Selection

Notes

- Spine beam kits are structural raceways with front removable covers and internal cable management trough, and can be supported by legs, end panels or 21h Calibrate storage elements.
- Spine beams can be ordered with or without multi-circuit powerways, or with junction box for hardwiring.
- Beams with powerways can accommodate up to 8 duplex outlets, 4 locations per each side of beam.
- Beams have electrical and data access holes in bottom at each end of beam for feeding electrical and data cables into the trough. See electrical section for wiring schematics.
- Duplex outlet locations can also accommodate a single gang data device plate (in lieu of a duplex outlet) with the use of an adapter (E-DJA).
- Spine beams can accommodate tackable or whiteboard screens as well as glass screens.
- Standard NEMA outlets.
- Outlets sold separately.
- Decorative outlets cannot be used.

Powered and Chicago Powered Spine Beam Kits

POWERED SPINE BEAM KITS

W	Model Number	List	Grade C Paint
36	T-BP36	1,176	+10
42	T-BP42	1,230	+10
48	T-BP48	1,280	+10
54	T-BP54	1,419	+10
60	T-BP60	1,454	+10
66	T-BP66	1,546	+10
72	T-BP72	1,623	+10
78	T-BP78	1,737	+10
84	T-BP84	1,835	+10
90	T-BP90	1,935	+10
96	T-BP96	2,020	+10

CHICAGO POWERED SPINE BEAM KITS

W	Model Number	List	Grade C Paint
36	T-BPC36	1,176	+10
42	T-BPC42	1,230	+10
48	T-BPC48	1,280	+10
54	T-BPC54	1,419	+10
60	T-BPC60	1,454	+10
66	T-BPC66	1,546	+10
72	T-BPC72	1,623	+10
78	T-BPC78	1,737	+10
84	T-BPC84	1,835	+10
90	T-BPC90	1,935	+10
96	T-BPC96	2,020	+10

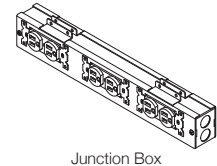
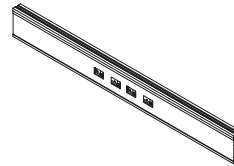
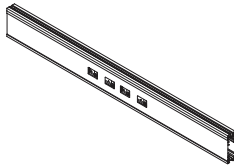

Junction Box

Specify

- Paint Selection

Notes

- Spine beam kits are structural raceways with front removable covers and internal cable management trough, and can be supported by legs, end panels or 21h Calibrate storage elements.
- Spine beams can be ordered with or without multi-circuit powerways, or with junction box for hardwiring.
- Beams with powerways can accommodate up to 8 duplex outlets, 4 locations per each side of beam.
- Beams have electrical and data access holes in bottom at each end of beam for feeding electrical and data cables into the trough. See electrical section for wiring schematics.
- Duplex outlet locations can also accommodate a single gang data device plate (in lieu of a duplex outlet) with the use of an adapter (E-DJA).
- Spine beams can accommodate tackable or whiteboard screens as well as glass screens.
- Junction box allows for two single gang outlets per side.
- Junction boxes do not include electrical connectors.
- Boxes are UL listed.
- Boxes have standard 0.875" knockouts for electrical connectors.
- Junction boxes can be used with either 15 amp or 20 amp single gang outlets.
- Standard NEMA outlets.
- Outlets sold separately.
- Decorative outlets cannot be used.

Legs for 21" High Spine Beams

T-LEGS FOR 21 HIGH SPINE BEAMS

D	Model Number	List	Grade C Paint
12	T-BTLEG2112	320	+25
18	T-BTLEG2118	332	+25

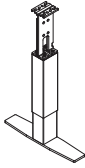

12" Deep

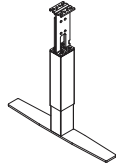

18" Deep

DISC LEGS FOR 21 HIGH SPINE BEAMS

Diameter	Model Number	List	Grade C Paint
12	T-BDLEG2112	414	+25
18	T-BDLEG2118	507	+25

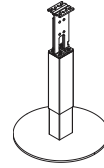

12" Diameter

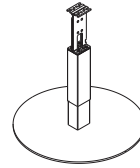

18" Diameter

POST LEGS FOR 21 HIGH SPINE BEAMS

Model Number	List	Grade C Paint
T-BPLEG21	296	+25



Specify

- Paint Selection

Notes

- Legs are used to support Spine Beam at end of beam length or shared at seam between two beam sections.
- Legs cannot be placed in "middle" of beam.
- Legs "telescope" 2-inches for leveling spine beam from end to end, and can be adjusted for front to back leveling as well.
- Heights indicate nominal height to top of beam.
- Base of leg is 1/4 high and can sit under table feet or any storage elements.

Legs for 25" High Spine Beams

T-LEGS FOR 25 HIGH SPINE BEAMS

D	Model Number	List	Grade C Paint
18	T-BTLEG2518	370	+25

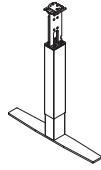

DISC LEGS FOR 25 HIGH SPINE BEAMS

Diameter	Model Number	List	Grade C Paint
18	T-BDLEG2518	545	+25

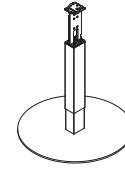

POST LEGS FOR 25 HIGH SPINE BEAMS

Model Number	List	Grade C Paint
T-BPLEG25	334	+25



Specify

- Paint Selection

Notes

- Legs are used to support Spine Beam at end of beam length or shared at seam between two beam sections.
- Legs cannot be placed in "middle" of beam.
- Legs "telescope" 2-inches for leveling spine beam from end to end, and can be adjusted for front to back leveling as well.
- Heights indicate nominal height to top of beam.
- Base of leg is 1/4 high and can sit under table feet or any storage elements.

Legs for 29" High Spine Beams

T-LEGS FOR 29 HIGH SPINE BEAMS

H	Model Number	List	Grade C Paint
18	T-BTLEG2918	370	+25

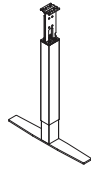

DISC LEGS FOR 29 HIGH SPINE BEAMS

H	Model Number	List	Grade C Paint
18	T-BDLEG2918	545	+25

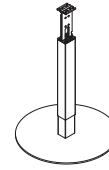

POST LEGS FOR 29 HIGH SPINE BEAMS

Model Number	List	Grade C Paint
T-BPLEG29	334	+25



Specify

- Paint Selection

Notes

- Legs are used to support Spine Beam at end of beam length or shared at seam between two beam sections.
- Legs cannot be placed in "middle" of beam.
- Legs "telescope" 2-inches for leveling spine beam from end to end, and can be adjusted for front to back leveling as well.
- Heights indicate nominal height to top of beam.
- Base of leg is 1/4 high and can sit under table feet or any storage elements.

Endcaps, Supports, Flush Mount Connection Kits and Wall Anchor Brackets

ENDCAP

Model Number	List	Grade C Paint
T-BREC	53	+10

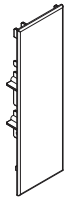

Front Side

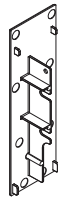

Back Side

Specify

- Paint Selection

Notes

- Endcaps are required to cap the end of a spine beam section at the end of a cluster.
- Endcaps are not needed when end panels are used.

VERTICAL SUPPORT FOR STORAGE MOUNTING

Model Number	List
T-BVS	143

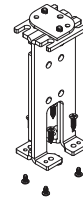

Specify

Notes

- Order this support when mounting the end of a spine beam on top of 21h Calibrate storage elements.
- This connector can be used shared between two beam sections as long as both sections are sitting on top of a storage element.

FLUSH MOUNT CONNECTION KIT

Model Number	List
T-BVSFLUSH	249

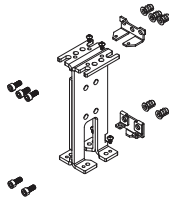

Specify

Notes

- Order this connector when mounting a beam section flush against the side of a storage element.

BEAM WALL ANCHOR BRACKET

Model Number	List
T-BWAB	107

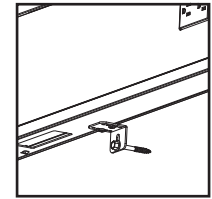
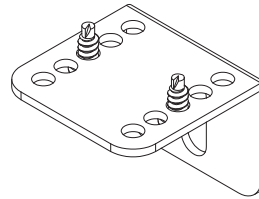

Specify

- Paint Selection (Grade C +10)

Notes

- Wall Anchors are sold in pairs. Install 2 anchors for each Beam section.
- The Wall Anchor is used to provide additional stability where the Beam is stationed directly against a wall.
- The Wall Anchor is to be used in addition to post legs, and does not replace them.
- The Wall Anchor must be installed to a wall stud or other structural component of the wall. It is the responsibility of the installer to determine a suitable screw for the substrate that it will attach to.

90° and 120° Connection Kits

90° CONNECTION KITS

Connection Type	Model Number	List	Grade C Paint
2-Way	T-B2W90C	238	+10
3-Way	T-B3W90C	238	+10
4-Way	T-B4W90C	238	+10

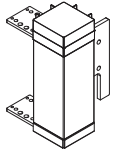

2-Way Connection Kit

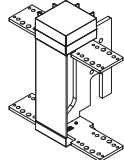

3-Way Connection Kit

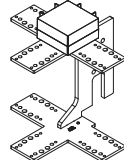

4-Way Connection Kit

120° CONNECTION KITS

Connection Type	Model Number	List	Grade C Paint
2-Way	T-B2W120C	238	+10
3-Way	T-B3W120C	238	+10

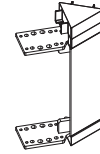

2-Way Connection Kit

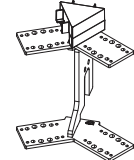

3-Way Connection Kit

Specify **Notes**

- Paint Selection
- 90 degree connection kits join beam sections at 90 degree angles for 2, 3 or 4 beam sections.
- Note: All spine beams must be supported by at least one leg per connection.

Specify **Notes**

- Paint Selection
- 120 degree connection kits join beam sections at 120 degree angles for 2 or 3 beam sections.
- Note: All spine beams must be supported by at least one leg per connection.

SINGLE END MOUNTING HEIGHT 21", 25" & 29" GRAIN DIRECTIONS												
HEIGHT	WIDTH											
	24	30	36	42	48	54	60	66	72	78	84	90
29	Vert./Horz.	Vert./Horz.	Vert./Horz.	Vert./Horz.	Vert./Horz.	Vert./Horz.	Horizontal	Horizontal	Horizontal	Horizontal	Horizontal	Horizontal
42	Vert./Horz.	Vert./Horz.	Vert./Horz.	Vert./Horz.	Vert./Horz.	Vert./Horz.	Horizontal	Horizontal	Horizontal	Horizontal	Horizontal	Horizontal
46	Vert./Horz.	Vert./Horz.	Vert./Horz.	Vert./Horz.	Vert./Horz.	Vert./Horz.	Horizontal	Horizontal	Horizontal	Horizontal	Horizontal	Horizontal
50	Vert./Horz.	Vert./Horz.	Vert./Horz.	Vert./Horz.	Vert./Horz.	Vert./Horz.	Horizontal	Horizontal	Horizontal	Horizontal	Horizontal	Horizontal
58	Vert./Horz.	Vert./Horz.	Vert./Horz.	Vert./Horz.	Vert./Horz.	Vert./Horz.	Horizontal	Horizontal	Horizontal	Horizontal	Horizontal	Horizontal

DOUBLE END MOUNTING HEIGHT 21", 25" & 29" GRAIN DIRECTIONS								
HEIGHT	WIDTH							
	48	54	60	66	72	78	84	90
29	Vert./Horz.	Vert./Horz.	Horizontal	Horizontal	Horizontal	Horizontal	Horizontal	Horizontal
42	Vert./Horz.	Vert./Horz.	Horizontal	Horizontal	Horizontal	Horizontal	Horizontal	Horizontal
46	Vert./Horz.	Vert./Horz.	Horizontal	Horizontal	Horizontal	Horizontal	Horizontal	Horizontal
50	Vert./Horz.	Vert./Horz.	Horizontal	Horizontal	Horizontal	Horizontal	Horizontal	Horizontal
58	Vert./Horz.	Vert./Horz.	Horizontal	Horizontal	Horizontal	Horizontal	Horizontal	Horizontal

MID MOUNT MOUNTING HEIGHT 21", 25" & 29" GRAIN DIRECTIONS												
HEIGHT	WIDTH											
	24	30	36	42	48	54	60	66	72	78	84	90
29	Vert./Horz.	Vert./Horz.	Vert./Horz.	Vert./Horz.	Vert./Horz.	Vert./Horz.	Horizontal	Horizontal	Horizontal	Horizontal	Horizontal	Horizontal
42	Vert./Horz.	Vert./Horz.	Vert./Horz.	Vert./Horz.	Vert./Horz.	Vert./Horz.	Horizontal	Horizontal	Horizontal	Horizontal	Horizontal	Horizontal
46	Vert./Horz.	Vert./Horz.	Vert./Horz.	Vert./Horz.	Vert./Horz.	Vert./Horz.	Horizontal	Horizontal	Horizontal	Horizontal	Horizontal	Horizontal
50	Vert./Horz.	Vert./Horz.	Vert./Horz.	Vert./Horz.	Vert./Horz.	Vert./Horz.	Horizontal	Horizontal	Horizontal	Horizontal	Horizontal	Horizontal
58	Vert./Horz.	Vert./Horz.	Vert./Horz.	Vert./Horz.	Vert./Horz.	Vert./Horz.	Horizontal	Horizontal	Horizontal	Horizontal	Horizontal	Horizontal

WING PANEL LEFT AND RIGHT GRAIN DIRECTIONS		
HEIGHT	WIDTH	
	24	30
29	Vert./Horz.	Vert./Horz.
42	Vert./Horz.	Vert./Horz.
46	Vert./Horz.	Vert./Horz.
50	Vertical	Vertical
58	Vertical	Vertical

Note: 58" high panels with 21" Beam mounting height are not available.

Product Details

Gallery Panel Examples

Single End

24" - 90" Wide*
Left or Right

*Over 66" Wide needs support

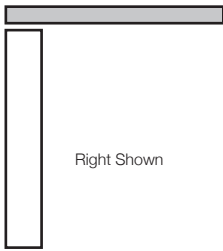

Double End

48" - 90" Wide

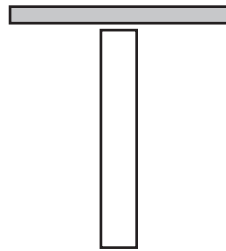

Single End for Wing

48" - 90" Wide
Left or Right

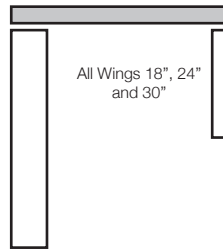

Mid Mount End

24" - 90" Wide*
Left or Right

*Over 66" Wide needs support

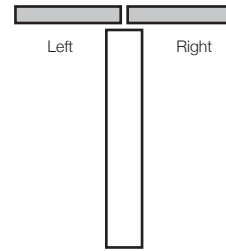

Mid Mount End for Wing

48" - 90" Wide
Left or Right

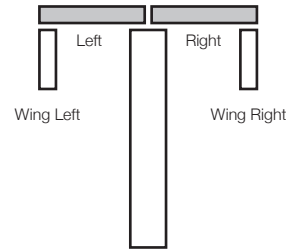

Single Spine

24" - 90" Wide*
Non-Handed

*Over 66" Wide needs support

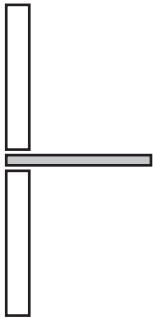

Double Spine

48" - 90" Wide
Non-Handed

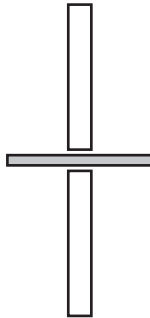

Single Spine for Wing

48" - 90" Wide
Left or Right

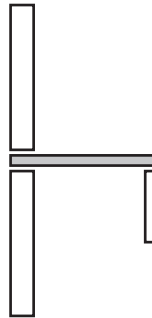

Mid Mount Spine

24" - 90" Wide*
Non-Handed

*Over 66" Wide needs support

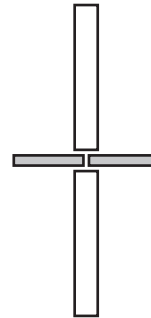

Mid Mount Spine for Wing

60" - 90" Wide
Left or Right

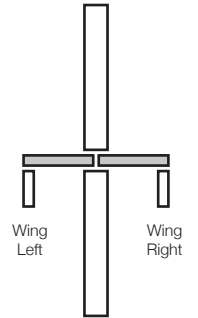

Laminate Gallery Panels – Beam Mount, Single End

21" BEAM MOUNT, HORIZONTAL GRAIN PATTERN – SINGLE END

H	W	Left	Right	List
		Model Number	Model Number	
29	24	T-SLEP292421L	T-SLEP292421R	585
29	30	T-SLEP293021L	T-SLEP293021R	614
29	36	T-SLEP293621L	T-SLEP293621R	631
29	42	T-SLEP294221L	T-SLEP294221R	644
29	48	T-SLEP294821L	T-SLEP294821R	654
29	54	T-SLEP295421L	T-SLEP295421R	664
29	60	T-SLEP296021L	T-SLEP296021R	785
29	66	T-SLEP296621L	T-SLEP296621R	825
29	72	T-SLEP297221L	T-SLEP297221R	879
29	78	T-SLEP297821L	T-SLEP297821R	931
29	84	T-SLEP298421L	T-SLEP298421R	984
29	90	T-SLEP299021L	T-SLEP299021R	1,037
42	24	T-SLEP422421L	T-SLEP422421R	629
42	30	T-SLEP423021L	T-SLEP423021R	678
42	36	T-SLEP423621L	T-SLEP423621R	721
42	42	T-SLEP424221L	T-SLEP424221R	762
42	48	T-SLEP424821L	T-SLEP424821R	806
42	54	T-SLEP425421L	T-SLEP425421R	847
42	60	T-SLEP426021L	T-SLEP426021R	957
42	66	T-SLEP426621L	T-SLEP426621R	1,029
42	72	T-SLEP427221L	T-SLEP427221R	1,058
42	78	T-SLEP427821L	T-SLEP427821R	1,110
42	84	T-SLEP428421L	T-SLEP428421R	1,151
42	90	T-SLEP429021L	T-SLEP429021R	1,192

21" BEAM MOUNT, HORIZONTAL GRAIN PATTERN – SINGLE END

H	W	Left	Right	List
		Model Number	Model Number	
46	24	T-SLEP462421L	T-SLEP462421R	651
46	30	T-SLEP463021L	T-SLEP463021R	710
46	36	T-SLEP463621L	T-SLEP463621R	765
46	42	T-SLEP464221L	T-SLEP464221R	821
46	48	T-SLEP464821L	T-SLEP464821R	881
46	54	T-SLEP465421L	T-SLEP465421R	940
46	60	T-SLEP466021L	T-SLEP466021R	1,044
46	66	T-SLEP466621L	T-SLEP466621R	1,128
46	72	T-SLEP467221L	T-SLEP467221R	1,158
46	78	T-SLEP467821L	T-SLEP467821R	1,199
46	84	T-SLEP468421L	T-SLEP468421R	1,234
46	90	T-SLEP469021L	T-SLEP469021R	1,268
50	24	T-SLEP502421L	T-SLEP502421R	672
50	30	T-SLEP503021L	T-SLEP503021R	741
50	36	T-SLEP503621L	T-SLEP503621R	809
50	42	T-SLEP504221L	T-SLEP504221R	881
50	48	T-SLEP504821L	T-SLEP504821R	955
50	54	T-SLEP505421L	T-SLEP505421R	1,032
50	60	T-SLEP506021L	T-SLEP506021R	1,131
50	66	T-SLEP506621L	T-SLEP506621R	1,228
50	72	T-SLEP507221L	T-SLEP507221R	1,259
50	78	T-SLEP507821L	T-SLEP507821R	1,288
50	84	T-SLEP508421L	T-SLEP508421R	1,317
50	90	T-SLEP509021L	T-SLEP509021R	1,345

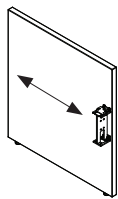

Left Hand Shown

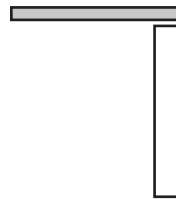

Left Hand Shown

Specify

- Laminate with matching edge

Notes

- Cannot be used freestanding, must be attached to a Beam.
- PowerBeam gallery panels are ordered specific to Beam height.
- Gallery panels add 1 1/8" between or at the end of Beam sections.
- Any gallery panel that extends more than 60" from the Beam must be tied to storage or similar support.

Laminate Gallery Panels – Beam Mount, Single End

25" BEAM MOUNT, HORIZONTAL GRAIN PATTERN – SINGLE END

H	W	Left	Right	List
		Model Number	Model Number	
29	24	T-SLEP292425L	T-SLEP292425R	585
29	30	T-SLEP293025L	T-SLEP293025R	614
29	36	T-SLEP293625L	T-SLEP293625R	631
29	42	T-SLEP294225L	T-SLEP294225R	644
29	48	T-SLEP294825L	T-SLEP294825R	654
29	54	T-SLEP295425L	T-SLEP295425R	664
29	60	T-SLEP296025L	T-SLEP296025R	785
29	66	T-SLEP296625L	T-SLEP296625R	825
29	72	T-SLEP297225L	T-SLEP297225R	879
29	78	T-SLEP297825L	T-SLEP297825R	931
29	84	T-SLEP298425L	T-SLEP298425R	984
29	90	T-SLEP299025L	T-SLEP299025R	1,037
42	24	T-SLEP422425L	T-SLEP422425R	629
42	30	T-SLEP423025L	T-SLEP423025R	678
42	36	T-SLEP423625L	T-SLEP423625R	721
42	42	T-SLEP424225L	T-SLEP424225R	762
42	48	T-SLEP424825L	T-SLEP424825R	806
42	54	T-SLEP425425L	T-SLEP425425R	847
42	60	T-SLEP426025L	T-SLEP426025R	957
42	66	T-SLEP426625L	T-SLEP426625R	1,029
42	72	T-SLEP427225L	T-SLEP427225R	1,058
42	78	T-SLEP427825L	T-SLEP427825R	1,110
42	84	T-SLEP428425L	T-SLEP428425R	1,151
42	90	T-SLEP429025L	T-SLEP429025R	1,192

25" BEAM MOUNT, HORIZONTAL GRAIN PATTERN – SINGLE END

H	W	Left	Right	List
		Model Number	Model Number	
46	24	T-SLEP462425L	T-SLEP462425R	651
46	30	T-SLEP463025L	T-SLEP463025R	710
46	36	T-SLEP463625L	T-SLEP463625R	765
46	42	T-SLEP464225L	T-SLEP464225R	821
46	48	T-SLEP464825L	T-SLEP464825R	881
46	54	T-SLEP465425L	T-SLEP465425R	940
46	60	T-SLEP466025L	T-SLEP466025R	1,044
46	66	T-SLEP466625L	T-SLEP466625R	1,128
46	72	T-SLEP467225L	T-SLEP467225R	1,158
46	78	T-SLEP467825L	T-SLEP467825R	1,199
46	84	T-SLEP468425L	T-SLEP468425R	1,234
46	90	T-SLEP469025L	T-SLEP469025R	1,268
50	24	T-SLEP502425L	T-SLEP502425R	672
50	30	T-SLEP503025L	T-SLEP503025R	741
50	36	T-SLEP503625L	T-SLEP503625R	809
50	42	T-SLEP504225L	T-SLEP504225R	881
50	48	T-SLEP504825L	T-SLEP504825R	955
50	54	T-SLEP505425L	T-SLEP505425R	1,032
50	60	T-SLEP506025L	T-SLEP506025R	1,131
50	66	T-SLEP506625L	T-SLEP506625R	1,228
50	72	T-SLEP507225L	T-SLEP507225R	1,259
50	78	T-SLEP507825L	T-SLEP507825R	1,288
50	84	T-SLEP508425L	T-SLEP508425R	1,317
50	90	T-SLEP509025L	T-SLEP509025R	1,345

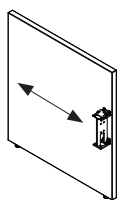

Left Hand Shown

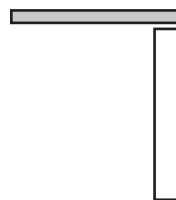

Left Hand Shown

Specify

• Laminate with matching edge

Notes

- Cannot be used freestanding, must be attached to a Beam.
- PowerBeam gallery panels are ordered specific to Beam height.
- Gallery panels add 1 1/8" between or at the end of Beam sections.
- Any gallery panel that extends more than 60" from the Beam must be tied to storage or similar support.

Laminate Gallery Panels – Beam Mount, Single End

25" BEAM MOUNT, HORIZONTAL GRAIN PATTERN – SINGLE END

H	W	Left	Right	List
		Model Number	Model Number	
58	24	T-SLEP582425L	T-SLEP582425R	749
58	30	T-SLEP583025L	T-SLEP583025R	821
58	36	T-SLEP583625L	T-SLEP583625R	886
58	42	T-SLEP584225L	T-SLEP584225R	954
58	48	T-SLEP584825L	T-SLEP584825R	1,007
58	54	T-SLEP585425L	T-SLEP585425R	1,060
58	60	T-SLEP586025L	T-SLEP586025R	1,155
58	66	T-SLEP586625L	T-SLEP586625R	1,250
58	72	T-SLEP587225L	T-SLEP587225R	1,344
58	78	T-SLEP587825L	T-SLEP587825R	1,438
58	84	T-SLEP588425L	T-SLEP588425R	1,533
58	90	T-SLEP589025L	T-SLEP589025R	1,628

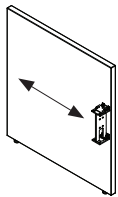

Left Hand Shown

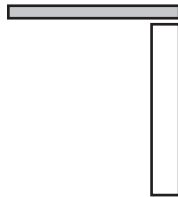

Left Hand Shown

Specify

- Laminate with matching edge

Notes

- Cannot be used freestanding, must be attached to a Beam.
- PowerBeam gallery panels are ordered specific to Beam height.
- Gallery panels add 1 1/8" between or at the end of Beam sections.
- Any gallery panel that extends more than 60" from the Beam must be tied to storage or similar support.

Laminate Gallery Panels – Beam Mount, Single End

29" BEAM MOUNT, HORIZONTAL GRAIN PATTERN – SINGLE END

H	W	Left	Right	List
		Model Number	Model Number	
29	24	T-SLEP292429L	T-SLEP292429R	585
29	30	T-SLEP293029L	T-SLEP293029R	614
29	36	T-SLEP293629L	T-SLEP293629R	631
29	42	T-SLEP294229L	T-SLEP294229R	644
29	48	T-SLEP294829L	T-SLEP294829R	654
29	54	T-SLEP295429L	T-SLEP295429R	664
29	60	T-SLEP296029L	T-SLEP296029R	785
29	66	T-SLEP296629L	T-SLEP296629R	825
29	72	T-SLEP297229L	T-SLEP297229R	879
29	78	T-SLEP297829L	T-SLEP297829R	931
29	84	T-SLEP298429L	T-SLEP298429R	984
29	90	T-SLEP299029L	T-SLEP299029R	1,037
42	24	T-SLEP422429L	T-SLEP422429R	629
42	30	T-SLEP423029L	T-SLEP423029R	678
42	36	T-SLEP423629L	T-SLEP423629R	721
42	42	T-SLEP424229L	T-SLEP424229R	762
42	48	T-SLEP424829L	T-SLEP424829R	806
42	54	T-SLEP425429L	T-SLEP425429R	847
42	60	T-SLEP426029L	T-SLEP426029R	957
42	66	T-SLEP426629L	T-SLEP426629R	1,029
42	72	T-SLEP427229L	T-SLEP427229R	1,058
42	78	T-SLEP427829L	T-SLEP427829R	1,110
42	84	T-SLEP428429L	T-SLEP428429R	1,151
42	90	T-SLEP429029L	T-SLEP429029R	1,192

29" BEAM MOUNT, HORIZONTAL GRAIN PATTERN

H	W	Left	Right	List
		Model Number	Model Number	
46	24	T-SLEP462429L	T-SLEP462429R	651
46	30	T-SLEP463029L	T-SLEP463029R	710
46	36	T-SLEP463629L	T-SLEP463629R	765
46	42	T-SLEP464229L	T-SLEP464229R	821
46	48	T-SLEP464829L	T-SLEP464829R	881
46	54	T-SLEP465429L	T-SLEP465429R	940
46	60	T-SLEP466029L	T-SLEP466029R	1,044
46	66	T-SLEP466629L	T-SLEP466629R	1,128
46	72	T-SLEP467229L	T-SLEP467229R	1,158
46	78	T-SLEP467829L	T-SLEP467829R	1,199
46	84	T-SLEP468429L	T-SLEP468429R	1,234
46	90	T-SLEP469029L	T-SLEP469029R	1,268
50	24	T-SLEP502429L	T-SLEP502429R	672
50	30	T-SLEP503029L	T-SLEP503029R	741
50	36	T-SLEP503629L	T-SLEP503629R	809
50	42	T-SLEP504229L	T-SLEP504229R	881
50	48	T-SLEP504829L	T-SLEP504829R	955
50	54	T-SLEP505429L	T-SLEP505429R	1,032
50	60	T-SLEP506029L	T-SLEP506029R	1,131
50	66	T-SLEP506629L	T-SLEP506629R	1,228
50	72	T-SLEP507229L	T-SLEP507229R	1,259
50	78	T-SLEP507829L	T-SLEP507829R	1,288
50	84	T-SLEP508429L	T-SLEP508429R	1,317
50	90	T-SLEP509029L	T-SLEP509029R	1,345

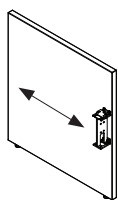

Left Hand Shown

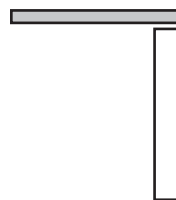

Left Hand Shown

Specify

- Laminate with matching edge

Notes

- Cannot be used freestanding, must be attached to a Beam.
- PowerBeam gallery panels are ordered specific to Beam height.
- Gallery panels add 1 1/8" between or at the end of Beam sections.
- Any gallery panel that extends more than 60" from the Beam must be tied to storage or similar support.

Laminate Gallery Panels – Beam Mount, Single End

29" BEAM MOUNT, HORIZONTAL GRAIN PATTERN – SINGLE END

H	W	Left	Right	List
		Model Number	Model Number	
58	24	T-SLEP582429L	T-SLEP582429R	749
58	30	T-SLEP583029L	T-SLEP583029R	821
58	36	T-SLEP583629L	T-SLEP583629R	886
58	42	T-SLEP584229L	T-SLEP584229R	954
58	48	T-SLEP584829L	T-SLEP584829R	1,007
58	54	T-SLEP585429L	T-SLEP585429R	1,060
58	60	T-SLEP586029L	T-SLEP586029R	1,155
58	66	T-SLEP586629L	T-SLEP586629R	1,250
58	72	T-SLEP587229L	T-SLEP587229R	1,344
58	78	T-SLEP587829L	T-SLEP587829R	1,438
58	84	T-SLEP588429L	T-SLEP588429R	1,533
58	90	T-SLEP589029L	T-SLEP589029R	1,628

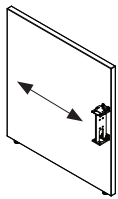

Left Hand Shown

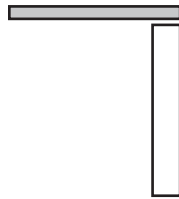

Left Hand Shown

Specify

- Laminate with matching edge

Notes

- Cannot be used freestanding, must be attached to a Beam.
- PowerBeam gallery panels are ordered specific to Beam height.
- Gallery panels add 1 1/8" between or at the end of Beam sections.
- Any gallery panel that extends more than 60" from the Beam must be tied to storage or similar support.

Laminate Gallery Panels – Beam Mount, Single End

21" BEAM MOUNT, VERTICAL GRAIN PATTERN – SINGLE END				
		Left	Right	
H	W	Model Number	Model Number	List
29	24	T-SLEP292421LV	T-SLEP292421RV	585
29	30	T-SLEP293021LV	T-SLEP293021RV	614
29	36	T-SLEP293621LV	T-SLEP293621RV	631
29	42	T-SLEP294221LV	T-SLEP294221RV	644
29	48	T-SLEP294821LV	T-SLEP294821RV	654
29	54	T-SLEP295421LV	T-SLEP295421RV	664
42	24	T-SLEP422421LV	T-SLEP422421RV	629
42	30	T-SLEP423021LV	T-SLEP423021RV	678
42	36	T-SLEP423621LV	T-SLEP423621RV	721
42	42	T-SLEP424221LV	T-SLEP424221RV	762
42	48	T-SLEP424821LV	T-SLEP424821RV	806
42	54	T-SLEP425421LV	T-SLEP425421RV	847

21" BEAM MOUNT, VERTICAL GRAIN PATTERN – SINGLE END				
		Left	Right	
H	W	Model Number	Model Number	List
46	24	T-SLEP462421LV	T-SLEP462421RV	651
46	30	T-SLEP463021LV	T-SLEP463021RV	710
46	36	T-SLEP463621LV	T-SLEP463621RV	765
46	42	T-SLEP464221LV	T-SLEP464221RV	821
46	48	T-SLEP464821LV	T-SLEP464821RV	881
46	54	T-SLEP465421LV	T-SLEP465421RV	940
50	24	T-SLEP502421LV	T-SLEP502421RV	672
50	30	T-SLEP503021LV	T-SLEP503021RV	741
50	36	T-SLEP503621LV	T-SLEP503621RV	809
50	42	T-SLEP504221LV	T-SLEP504221RV	881
50	48	T-SLEP504821LV	T-SLEP504821RV	955
50	54	T-SLEP505421LV	T-SLEP505421RV	1,032

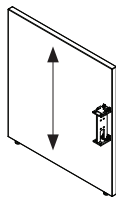

Left Hand Shown

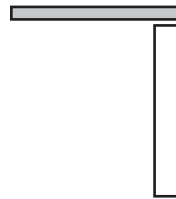

Left Hand Shown

Specify

- Laminate with matching edge

Notes

- Cannot be used freestanding, must be attached to a Beam.
- PowerBeam gallery panels are ordered specific to Beam height.
- Gallery panels add 1 1/8" between or at the end of Beam sections.

Laminate Gallery Panels – Beam Mount, Single End

25" BEAM MOUNT, VERTICAL GRAIN PATTERN – SINGLE END				
		Left	Right	
H	W	Model Number	Model Number	List
29	24	T-SLEP292425LV	T-SLEP292425RV	585
29	30	T-SLEP293025LV	T-SLEP293025RV	614
29	36	T-SLEP293625LV	T-SLEP293625RV	631
29	42	T-SLEP294225LV	T-SLEP294225RV	644
29	48	T-SLEP294825LV	T-SLEP294825RV	654
29	54	T-SLEP295425LV	T-SLEP295425RV	664
42	24	T-SLEP422425LV	T-SLEP422425RV	629
42	30	T-SLEP423025LV	T-SLEP423025RV	678
42	36	T-SLEP423625LV	T-SLEP423625RV	721
42	42	T-SLEP424225LV	T-SLEP424225RV	762
42	48	T-SLEP424825LV	T-SLEP424825RV	806
42	54	T-SLEP425425LV	T-SLEP425425RV	847
46	24	T-SLEP462425LV	T-SLEP462425RV	651
46	30	T-SLEP463025LV	T-SLEP463025RV	710
46	36	T-SLEP463625LV	T-SLEP463625RV	765
46	42	T-SLEP464225LV	T-SLEP464225RV	821
46	48	T-SLEP464825LV	T-SLEP464825RV	881
46	54	T-SLEP465425LV	T-SLEP465425RV	940

25" BEAM MOUNT, VERTICAL GRAIN PATTERN – SINGLE END				
		Left	Right	
H	W	Model Number	Model Number	List
50	24	T-SLEP502425LV	T-SLEP502425RV	672
50	30	T-SLEP503025LV	T-SLEP503025RV	741
50	36	T-SLEP503625LV	T-SLEP503625RV	809
50	42	T-SLEP504225LV	T-SLEP504225RV	881
50	48	T-SLEP504825LV	T-SLEP504825RV	955
50	54	T-SLEP505425LV	T-SLEP505425RV	1,032
58	24	T-SLEP582425LV	T-SLEP582425RV	749
58	30	T-SLEP583025LV	T-SLEP583025RV	821
58	36	T-SLEP583625LV	T-SLEP583625RV	886
58	42	T-SLEP584225LV	T-SLEP584225RV	954
58	48	T-SLEP584825LV	T-SLEP584825RV	1,007
58	54	T-SLEP585425LV	T-SLEP585425RV	1,060

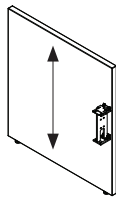

Left Hand Shown

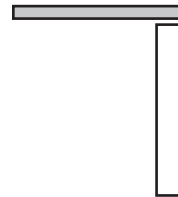

Left Hand Shown

Specify

- Laminate with matching edge

Notes

- Cannot be used freestanding, must be attached to a Beam.
- PowerBeam gallery panels are ordered specific to Beam height.
- Gallery panels add 1 1/8" between or at the end of Beam sections.

Laminate Gallery Panels – Beam Mount, Single End

29" BEAM MOUNT, VERTICAL GRAIN PATTERN – SINGLE END				
		Left	Right	
H	W	Model Number	Model Number	List
29	24	T-SLEP292429LV	T-SLEP292429RV	585
29	30	T-SLEP293029LV	T-SLEP293029RV	614
29	36	T-SLEP293629LV	T-SLEP293629RV	631
29	42	T-SLEP294229LV	T-SLEP294229RV	644
29	48	T-SLEP294829LV	T-SLEP294829RV	654
29	54	T-SLEP295429LV	T-SLEP295429RV	664
42	24	T-SLEP422429LV	T-SLEP422429RV	629
42	30	T-SLEP423029LV	T-SLEP423029RV	678
42	36	T-SLEP423629LV	T-SLEP423629RV	721
42	42	T-SLEP424229LV	T-SLEP424229RV	762
42	48	T-SLEP424829LV	T-SLEP424829RV	806
42	54	T-SLEP425429LV	T-SLEP425429RV	847
46	24	T-SLEP462429LV	T-SLEP462429RV	651
46	30	T-SLEP463029LV	T-SLEP463029RV	710
46	36	T-SLEP463629LV	T-SLEP463629RV	765
46	42	T-SLEP464229LV	T-SLEP464229RV	821
46	48	T-SLEP464829LV	T-SLEP464829RV	881
46	54	T-SLEP465429LV	T-SLEP465429RV	940

29" BEAM MOUNT, VERTICAL GRAIN PATTERN – SINGLE END				
		Left	Right	
H	W	Model Number	Model Number	List
50	24	T-SLEP502429LV	T-SLEP502429RV	672
50	30	T-SLEP503029LV	T-SLEP503029RV	741
50	36	T-SLEP503629LV	T-SLEP503629RV	809
50	42	T-SLEP504229LV	T-SLEP504229RV	881
50	48	T-SLEP504829LV	T-SLEP504829RV	955
50	54	T-SLEP505429LV	T-SLEP505429RV	1,032
58	24	T-SLEP582429LV	T-SLEP582429RV	749
58	30	T-SLEP583029LV	T-SLEP583029RV	821
58	36	T-SLEP583629LV	T-SLEP583629RV	886
58	42	T-SLEP584229LV	T-SLEP584229RV	954
58	48	T-SLEP584829LV	T-SLEP584829RV	1,007
58	54	T-SLEP585429LV	T-SLEP585429RV	1,060

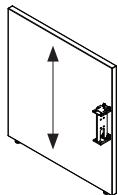

Left Hand Shown

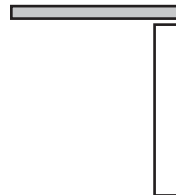

Left Hand Shown

Specify

- Laminate with matching edge

Notes

- Cannot be used freestanding, must be attached to a Beam.
- PowerBeam gallery panels are ordered specific to Beam height.
- Gallery panels add 1 1/8" between or at the end of Beam sections.

Laminate Gallery Panels – Beam Mount, Double End

21" BEAM MOUNT, HORIZONTAL GRAIN PATTERN – DOUBLE END

H	W	Model Number	List
29	48	T-SLEP294821	654
29	54	T-SLEP295421	664
29	60	T-SLEP296021	785
29	66	T-SLEP296621	825
29	72	T-SLEP297221	879
29	78	T-SLEP297821	931
29	84	T-SLEP298421	984
29	90	T-SLEP299021	1,037
42	48	T-SLEP424821	806
42	54	T-SLEP425421	847
42	60	T-SLEP426021	957
42	66	T-SLEP426621	1,029
42	72	T-SLEP427221	1,069
42	78	T-SLEP427821	1,110
42	84	T-SLEP428421	1,151
42	90	T-SLEP429021	1,192

21" BEAM MOUNT, HORIZONTAL GRAIN PATTERN – DOUBLE END

H	W	Model Number	List
46	48	T-SLEP464821	881
46	54	T-SLEP465421	940
46	60	T-SLEP466021	1,044
46	66	T-SLEP466621	1,128
46	72	T-SLEP467221	1,164
46	78	T-SLEP467821	1,199
46	84	T-SLEP468421	1,234
46	90	T-SLEP469021	1,268
50	48	T-SLEP504821	955
50	54	T-SLEP505421	1,032
50	60	T-SLEP506021	1,131
50	66	T-SLEP506621	1,228
50	72	T-SLEP507221	1,259
50	78	T-SLEP507821	1,288
50	84	T-SLEP508421	1,317
50	90	T-SLEP509021	1,345

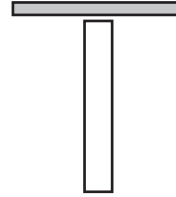
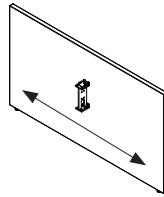

Specify

Notes

• Laminate with matching edge

- Cannot be used freestanding, must be attached to a Beam.
- PowerBeam gallery panels are ordered specific to Beam height.
- Gallery panels add 1 1/8" between or at the end of Beam sections.
- Any gallery panel that extends more than 60" from the Beam must be tied to storage or similar support.

Laminate Gallery Panels – Beam Mount, Double End

25" BEAM MOUNT, HORIZONTAL GRAIN PATTERN – DOUBLE END

H	W	Model Number	List
29	48	T-SLEP294825	654
29	54	T-SLEP295425	664
29	60	T-SLEP296025	785
29	66	T-SLEP296625	825
29	72	T-SLEP297225	879
29	78	T-SLEP297825	931
29	84	T-SLEP298425	984
29	90	T-SLEP299025	1,037
42	48	T-SLEP424825	806
42	54	T-SLEP425425	847
42	60	T-SLEP426025	957
42	66	T-SLEP426625	1,029
42	72	T-SLEP427225	1,069
42	78	T-SLEP427825	1,110
42	84	T-SLEP428425	1,151
42	90	T-SLEP429025	1,192
46	48	T-SLEP464825	881
46	54	T-SLEP465425	940
46	60	T-SLEP466025	1,044
46	66	T-SLEP466625	1,128
46	72	T-SLEP467225	1,164
46	78	T-SLEP467825	1,199
46	84	T-SLEP468425	1,234
46	90	T-SLEP469025	1,268

25" BEAM MOUNT, HORIZONTAL GRAIN PATTERN – DOUBLE END

H	W	Model Number	List
50	48	T-SLEP504825	955
50	54	T-SLEP505425	1,032
50	60	T-SLEP506025	1,131
50	66	T-SLEP506625	1,228
50	72	T-SLEP507225	1,259
50	78	T-SLEP507825	1,288
50	84	T-SLEP508425	1,317
50	90	T-SLEP509025	1,345
58	48	T-SLEP584825	1,007
58	54	T-SLEP585425	1,060
58	60	T-SLEP586025	1,155
58	66	T-SLEP586625	1,250
58	72	T-SLEP587225	1,344
58	78	T-SLEP587825	1,438
58	84	T-SLEP588425	1,533
58	90	T-SLEP589025	1,628

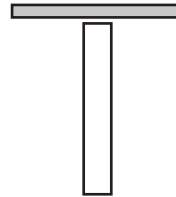
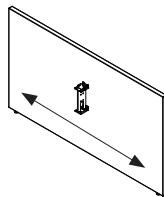

Specify

- Laminate with matching edge

Notes

- Cannot be used freestanding, must be attached to a Beam.
- PowerBeam gallery panels are ordered specific to Beam height.
- Gallery panels add 1 1/8" between or at the end of Beam sections.
- Any gallery panel that extends more than 60" from the Beam must be tied to storage or similar support.

Laminate Gallery Panels – Beam Mount, Double End

29" BEAM MOUNT, HORIZONTAL GRAIN PATTERN – DOUBLE END

H	W	Model Number	List
29	48	T-SLEP294829	654
29	54	T-SLEP295429	664
29	60	T-SLEP296029	785
29	66	T-SLEP296629	825
29	72	T-SLEP297229	879
29	78	T-SLEP297829	931
29	84	T-SLEP298429	984
29	90	T-SLEP299029	1,037
42	48	T-SLEP424829	806
42	54	T-SLEP425429	847
42	60	T-SLEP426029	957
42	66	T-SLEP426629	1,029
42	72	T-SLEP427229	1,069
42	78	T-SLEP427829	1,110
42	84	T-SLEP428429	1,151
42	90	T-SLEP429029	1,192
46	48	T-SLEP464829	881
46	54	T-SLEP465429	940
46	60	T-SLEP466029	1,044
46	66	T-SLEP466629	1,128
46	72	T-SLEP467229	1,164
46	78	T-SLEP467829	1,199
46	84	T-SLEP468429	1,234
46	90	T-SLEP469029	1,268

29" BEAM MOUNT, HORIZONTAL GRAIN PATTERN – DOUBLE END

H	W	Model Number	List
50	48	T-SLEP504829	955
50	54	T-SLEP505429	1,032
50	60	T-SLEP506029	1,131
50	66	T-SLEP506629	1,228
50	72	T-SLEP507229	1,259
50	78	T-SLEP507829	1,288
50	84	T-SLEP508429	1,317
50	90	T-SLEP509029	1,345
58	48	T-SLEP584829	1,007
58	54	T-SLEP585429	1,060
58	60	T-SLEP586029	1,155
58	66	T-SLEP586629	1,250
58	72	T-SLEP587229	1,344
58	78	T-SLEP587829	1,438
58	84	T-SLEP588429	1,533
58	90	T-SLEP589029	1,628

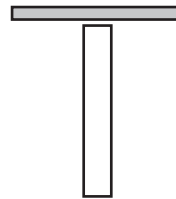
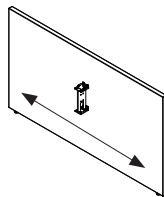

Specify

- Laminate with matching edge

Notes

- Cannot be used freestanding, must be attached to a Beam.
- PowerBeam gallery panels are ordered specific to Beam height.
- Gallery panels add 1 1/8" between or at the end of Beam sections.
- Any gallery panel that extends more than 60" from the Beam must be tied to storage or similar support.

Laminate Gallery Panels – Beam Mount, Double End

21" BEAM MOUNT, VERTICAL GRAIN PATTERN – DOUBLE END

H	W	Model Number	List
29	48	T-SLEP294821V	654
29	54	T-SLEP295421V	664
42	48	T-SLEP424821V	806
42	54	T-SLEP425421V	847
46	48	T-SLEP464821V	881
46	54	T-SLEP465421V	940
50	48	T-SLEP504821V	955
50	54	T-SLEP505421V	1,032

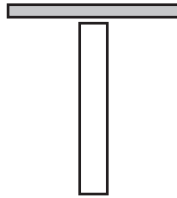
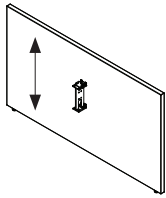

Specify

- Laminate with matching edge

Notes

- Cannot be used freestanding, must be attached to a Beam.
- PowerBeam gallery panels are ordered specific to Beam height.
- Gallery panels add 1 1/8" between or at the end of Beam sections.

Laminate Gallery Panels – Beam Mount, Double End

25" BEAM MOUNT, VERTICAL GRAIN PATTERN – DOUBLE END

H	W	Model Number	List
29	48	T-SLEP294825V	654
29	54	T-SLEP295425V	664
42	48	T-SLEP424825V	806
42	54	T-SLEP425425V	847
46	48	T-SLEP464825V	881
46	54	T-SLEP465425V	940
50	48	T-SLEP504825V	955
50	54	T-SLEP505425V	1,032
58	48	T-SLEP584825V	1,007
58	54	T-SLEP585425V	1,060

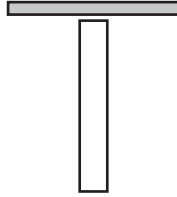
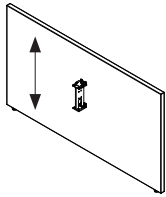

Specify

- Laminate with matching edge

Notes

- Cannot be used freestanding, must be attached to a Beam.
- PowerBeam gallery panels are ordered specific to Beam height.
- Gallery panels add 1 1/8" between or at the end of Beam sections.

Laminate Gallery Panels – Beam Mount, Double End

29" BEAM MOUNT, VERTICAL GRAIN PATTERN – DOUBLE END

H	W	Model Number	List
29	48	T-SLEP294829V	654
29	54	T-SLEP295429V	664
42	48	T-SLEP424829V	806
42	54	T-SLEP425429V	847
46	48	T-SLEP464829V	881
46	54	T-SLEP465429V	940
50	48	T-SLEP504829V	955
50	54	T-SLEP505429V	1,032
58	48	T-SLEP584829V	1,007
58	54	T-SLEP585429V	1,060

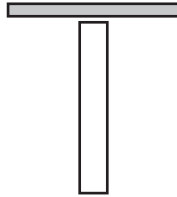
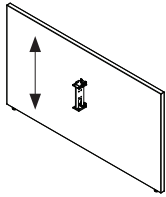

Specify

- Laminate with matching edge

Notes

- Cannot be used freestanding, must be attached to a Beam.
- PowerBeam gallery panels are ordered specific to Beam height.
- Gallery panels add 1 1/8" between or at the end of Beam sections.

Laminate Gallery Panels – Beam Mount for Wing, Single End

21" BEAM MOUNT FOR WING, HORIZONTAL GRAIN PATTERN – SINGLE END

H	W	Left	Right	List
		Model Number	Model Number	
29	48	T-SLPW294821L	T-SLPW294821R	687
29	54	T-SLPW295421L	T-SLPW295421R	696
29	60	T-SLPW296021L	T-SLPW296021R	818
29	66	T-SLPW296621L	T-SLPW296621R	858
29	72	T-SLPW297221L	T-SLPW297221R	912
29	78	T-SLPW297821L	T-SLPW297821R	965
29	84	T-SLPW298421L	T-SLPW298421R	1,018
29	90	T-SLPW299021L	T-SLPW299021R	1,071
42	48	T-SLPW424821L	T-SLPW424821R	839
42	54	T-SLPW425421L	T-SLPW425421R	880
42	60	T-SLPW426021L	T-SLPW426021R	990
42	66	T-SLPW426621L	T-SLPW426621R	1,060
42	72	T-SLPW427221L	T-SLPW427221R	1,101
42	78	T-SLPW427821L	T-SLPW427821R	1,142
42	84	T-SLPW428421L	T-SLPW428421R	1,184
42	90	T-SLPW429021L	T-SLPW429021R	1,225

21" BEAM MOUNT FOR WING, HORIZONTAL GRAIN PATTERN – SINGLE END

H	W	Left	Right	List
		Model Number	Model Number	
46	48	T-SLPW464821L	T-SLPW464821R	913
46	54	T-SLPW465421L	T-SLPW465421R	972
46	60	T-SLPW466021L	T-SLPW466021R	1,077
46	66	T-SLPW466621L	T-SLPW466621R	1,161
46	72	T-SLPW467221L	T-SLPW467221R	1,196
46	78	T-SLPW467821L	T-SLPW467821R	1,232
46	84	T-SLPW468421L	T-SLPW468421R	1,266
46	90	T-SLPW469021L	T-SLPW469021R	1,302
50	48	T-SLPW504821L	T-SLPW504821R	989
50	54	T-SLPW505421L	T-SLPW505421R	1,065
50	60	T-SLPW506021L	T-SLPW506021R	1,164
50	66	T-SLPW506621L	T-SLPW506621R	1,262
50	72	T-SLPW507221L	T-SLPW507221R	1,292
50	78	T-SLPW507821L	T-SLPW507821R	1,320
50	84	T-SLPW508421L	T-SLPW508421R	1,349
50	90	T-SLPW509021L	T-SLPW509021R	1,377

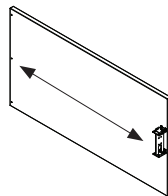

Left Hand Shown

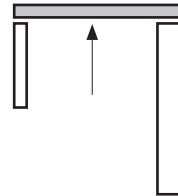

Left Hand Shown

Specify

- Laminate with matching edge

Notes

- Cannot be used freestanding, must be attached to a Beam.
- PowerBeam gallery panels are ordered specific to Beam height.
- Gallery panels add 1 1/8" between or at the end of Beam sections.
- Any gallery panel that extends more than 60" from the Beam must be tied to storage or similar support.

Laminate Gallery Panels – Beam Mount for Wing, Single End

25" BEAM MOUNT FOR WING, HORIZONTAL GRAIN PATTERN – SINGLE END

H	W	Left	Right	List
		Model Number	Model Number	
29	48	T-SLPW294825L	T-SLPW294825R	687
29	54	T-SLPW295425L	T-SLPW295425R	696
29	60	T-SLPW296025L	T-SLPW296025R	818
29	66	T-SLPW296625L	T-SLPW296625R	858
29	72	T-SLPW297225L	T-SLPW297225R	912
29	78	T-SLPW297825L	T-SLPW297825R	965
29	84	T-SLPW298425L	T-SLPW298425R	1,018
29	90	T-SLPW299025L	T-SLPW299025R	1,071
42	48	T-SLPW424825L	T-SLPW424825R	839
42	54	T-SLPW425425L	T-SLPW425425R	880
42	60	T-SLPW426025L	T-SLPW426025R	990
42	66	T-SLPW426625L	T-SLPW426625R	1,060
42	72	T-SLPW427225L	T-SLPW427225R	1,101
42	78	T-SLPW427825L	T-SLPW427825R	1,142
42	84	T-SLPW428425L	T-SLPW428425R	1,184
42	90	T-SLPW429025L	T-SLPW429025R	1,225
46	48	T-SLPW464825L	T-SLPW464825R	913
46	54	T-SLPW465425L	T-SLPW465425R	972
46	60	T-SLPW466025L	T-SLPW466025R	1,077
46	66	T-SLPW466625L	T-SLPW466625R	1,161
46	72	T-SLPW467225L	T-SLPW467225R	1,196
46	78	T-SLPW467825L	T-SLPW467825R	1,232
46	84	T-SLPW468425L	T-SLPW468425R	1,266
46	90	T-SLPW469025L	T-SLPW469025R	1,302

25" BEAM MOUNT FOR WING, HORIZONTAL GRAIN PATTERN – SINGLE END

H	W	Left	Right	List
		Model Number	Model Number	
50	48	T-SLPW504825L	T-SLPW504825R	989
50	54	T-SLPW505425L	T-SLPW505425R	1,065
50	60	T-SLPW506025L	T-SLPW506025R	1,164
50	66	T-SLPW506625L	T-SLPW506625R	1,262
50	72	T-SLPW507225L	T-SLPW507225R	1,292
50	78	T-SLPW507825L	T-SLPW507825R	1,320
50	84	T-SLPW508425L	T-SLPW508425R	1,349
50	90	T-SLPW509025L	T-SLPW509025R	1,377
58	48	T-SLPW584825L	T-SLPW584825R	1,041
58	54	T-SLPW585425L	T-SLPW585425R	1,093
58	60	T-SLPW586025L	T-SLPW586025R	1,188
58	66	T-SLPW586625L	T-SLPW586625R	1,282
58	72	T-SLPW587225L	T-SLPW587225R	1,376
58	78	T-SLPW587825L	T-SLPW587825R	1,471
58	84	T-SLPW588425L	T-SLPW588425R	1,566
58	90	T-SLPW589025L	T-SLPW589025R	1,660

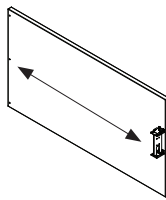

Left Hand Shown

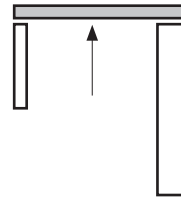

Left Hand Shown

Specify

- Laminate with matching edge

Notes

- Cannot be used freestanding, must be attached to a Beam.
- PowerBeam gallery panels are ordered specific to Beam height.
- Gallery panels add 1 1/8" between or at the end of Beam sections.
- Any gallery panel that extends more than 60" from the Beam must be tied to storage or similar support.

Laminate Gallery Panels – Beam Mount for Wing, Single End

29" BEAM MOUNT FOR WING, HORIZONTAL GRAIN PATTERN – SINGLE END

H	W	Left	Right	List
		Model Number	Model Number	
29	48	T-SLPW294829L	T-SLPW294829R	687
29	54	T-SLPW295429L	T-SLPW295429R	696
29	60	T-SLPW296029L	T-SLPW296029R	818
29	66	T-SLPW296629L	T-SLPW296629R	858
29	72	T-SLPW297229L	T-SLPW297229R	912
29	78	T-SLPW297829L	T-SLPW297829R	965
29	84	T-SLPW298429L	T-SLPW298429R	1,018
29	90	T-SLPW299029L	T-SLPW299029R	1,071
42	48	T-SLPW424829L	T-SLPW424829R	839
42	54	T-SLPW425429L	T-SLPW425429R	880
42	60	T-SLPW426029L	T-SLPW426029R	990
42	66	T-SLPW426629L	T-SLPW426629R	1,060
42	72	T-SLPW427229L	T-SLPW427229R	1,101
42	78	T-SLPW427829L	T-SLPW427829R	1,142
42	84	T-SLPW428429L	T-SLPW428429R	1,184
42	90	T-SLPW429029L	T-SLPW429029R	1,225
46	48	T-SLPW464829L	T-SLPW464829R	913
46	54	T-SLPW465429L	T-SLPW465429R	972
46	60	T-SLPW466029L	T-SLPW466029R	1,077
46	66	T-SLPW466629L	T-SLPW466629R	1,161
46	72	T-SLPW467229L	T-SLPW467229R	1,196
46	78	T-SLPW467829L	T-SLPW467829R	1,232
46	84	T-SLPW468429L	T-SLPW468429R	1,266
46	90	T-SLPW469029L	T-SLPW469029R	1,302

29" BEAM MOUNT FOR WING, HORIZONTAL GRAIN PATTERN – SINGLE END

H	W	Left	Right	List
		Model Number	Model Number	
50	48	T-SLPW504829L	T-SLPW504829R	989
50	54	T-SLPW505429L	T-SLPW505429R	1,065
50	60	T-SLPW506029L	T-SLPW506029R	1,164
50	66	T-SLPW506629L	T-SLPW506629R	1,262
50	72	T-SLPW507229L	T-SLPW507229R	1,292
50	78	T-SLPW507829L	T-SLPW507829R	1,320
50	84	T-SLPW508429L	T-SLPW508429R	1,349
50	90	T-SLPW509029L	T-SLPW509029R	1,377
58	48	T-SLPW584829L	T-SLPW584829R	1,041
58	54	T-SLPW585429L	T-SLPW585429R	1,093
58	60	T-SLPW586029L	T-SLPW586029R	1,188
58	66	T-SLPW586629L	T-SLPW586629R	1,282
58	72	T-SLPW587229L	T-SLPW587229R	1,376
58	78	T-SLPW587829L	T-SLPW587829R	1,471
58	84	T-SLPW588429L	T-SLPW588429R	1,566
58	90	T-SLPW589029L	T-SLPW589029R	1,660

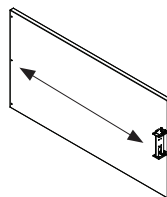

Left Hand Shown

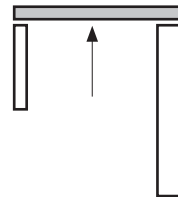

Left Hand Shown

Specify

- Laminate with matching edge

Notes

- Cannot be used freestanding, must be attached to a Beam.
- PowerBeam gallery panels are ordered specific to Beam height.
- Gallery panels add 1 1/8" between or at the end of Beam sections.
- Any gallery panel that extends more than 60" from the Beam must be tied to storage or similar support.

Laminate Gallery Panels – Beam Mount for Wing, Single End

21" BEAM MOUNT FOR WING, VERTICAL GRAIN PATTERN – SINGLE END

H	W	Left	Right	List
		Model Number	Model Number	
29	48	T-SLPW294821LV	T-SLPW294821RV	687
29	54	T-SLPW295421LV	T-SLPW295421RV	696
42	48	T-SLPW424821LV	T-SLPW424821RV	839
42	54	T-SLPW425421LV	T-SLPW425421RV	880
46	48	T-SLPW464821LV	T-SLPW464821RV	913
46	54	T-SLPW465421LV	T-SLPW465421RV	972
50	48	T-SLPW504821LV	T-SLPW504821RV	989
50	54	T-SLPW505421LV	T-SLPW505421RV	1,065

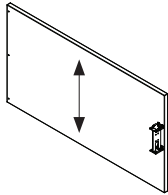

Left Hand Shown

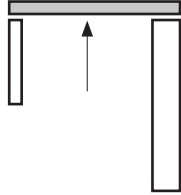

Left Hand Shown

Specify

- Laminate with matching edge

Notes

- Cannot be used freestanding, must be attached to a Beam.
- PowerBeam gallery panels are ordered specific to Beam height.
- Gallery panels add 1 1/8" between or at the end of Beam sections.

Laminate Gallery Panels – Beam Mount for Wing, Single End

25" BEAM MOUNT FOR WING, VERTICAL GRAIN PATTERN – SINGLE END

H	W	Left	Right	List
		Model Number	Model Number	
29	48	T-SLPW294825LV	T-SLPW294825RV	687
29	54	T-SLPW295425LV	T-SLPW295425RV	696
42	48	T-SLPW424825LV	T-SLPW424825RV	839
42	54	T-SLPW425425LV	T-SLPW425425RV	880
46	48	T-SLPW464825LV	T-SLPW464825RV	913
46	54	T-SLPW465425LV	T-SLPW465425RV	972
50	48	T-SLPW504825LV	T-SLPW504825RV	989
50	54	T-SLPW505425LV	T-SLPW505425RV	1,065
58	48	T-SLPW584825LV	T-SLPW584825RV	1,041
58	54	T-SLPW585425LV	T-SLPW585425RV	1,093

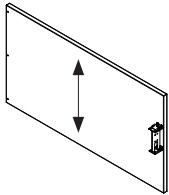

Left Hand Shown

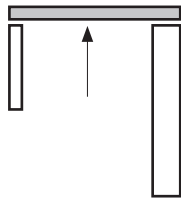

Left Hand Shown

Specify

- Laminate with matching edge

Notes

- Cannot be used freestanding, must be attached to a Beam.
- PowerBeam gallery panels are ordered specific to Beam height.
- Gallery panels add 1 1/8" between or at the end of Beam sections.

Laminate Gallery Panels – Beam Mount for Wing, Single End

29" BEAM MOUNT FOR WING, VERTICAL GRAIN PATTERN – SINGLE END

H	W	Left	Right	List
		Model Number	Model Number	
29	48	T-SLPW294829LV	T-SLPW294829RV	687
29	54	T-SLPW295429LV	T-SLPW295429RV	696
42	48	T-SLPW424829LV	T-SLPW424829RV	839
42	54	T-SLPW425429LV	T-SLPW425429RV	880
46	48	T-SLPW464829LV	T-SLPW464829RV	913
46	54	T-SLPW465429LV	T-SLPW465429RV	972
50	48	T-SLPW504829LV	T-SLPW504829RV	989
50	54	T-SLPW505429LV	T-SLPW505429RV	1,065
58	48	T-SLPW584829LV	T-SLPW584829RV	1,041
58	54	T-SLPW585429LV	T-SLPW585429RV	1,093

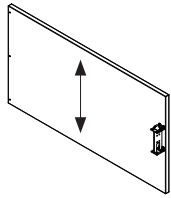

Left Hand Shown

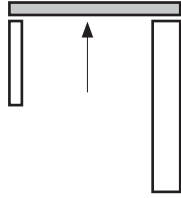

Left Hand Shown

Specify

- Laminate with matching edge

Notes

- Cannot be used freestanding, must be attached to a Beam.
- PowerBeam gallery panels are ordered specific to Beam height.
- Gallery panels add 1 1/8" between or at the end of Beam sections.

Laminate Gallery Panels – Mid Mount End

21" MID MOUNT END, HORIZONTAL GRAIN PATTERN

H	W	21" MID MOUNT END, HORIZONTAL GRAIN PATTERN		List
		Left	Right	
		Model Number	Model Number	
29	24	T-SLM292421L	T-SLM292421R	585
29	30	T-SLM293021L	T-SLM293021R	614
29	36	T-SLM293621L	T-SLM293621R	631
29	42	T-SLM294221L	T-SLM294221R	644
29	48	T-SLM294821L	T-SLM294821R	654
29	54	T-SLM295421L	T-SLM295421R	664
29	60	T-SLM296021L	T-SLM296021R	785
29	66	T-SLM296621L	T-SLM296621R	825
29	72	T-SLM297221L	T-SLM297221R	879
29	78	T-SLM297821L	T-SLM297821R	931
29	84	T-SLM298421L	T-SLM298421R	984
29	90	T-SLM299021L	T-SLM299021R	1,037
42	24	T-SLM422421L	T-SLM422421R	629
42	30	T-SLM423021L	T-SLM423021R	678
42	36	T-SLM423621L	T-SLM423621R	721
42	42	T-SLM424221L	T-SLM424221R	762
42	48	T-SLM424821L	T-SLM424821R	806
42	54	T-SLM425421L	T-SLM425421R	847
42	60	T-SLM426021L	T-SLM426021R	957
42	66	T-SLM426621L	T-SLM426621R	1,029
42	72	T-SLM427221L	T-SLM427221R	1,069
42	78	T-SLM427821L	T-SLM427821R	1,110
42	84	T-SLM428421L	T-SLM428421R	1,151
42	90	T-SLM429021L	T-SLM429021R	1,192

21" MID MOUNT END, HORIZONTAL GRAIN PATTERN

H	W	21" MID MOUNT END, HORIZONTAL GRAIN PATTERN		List
		Left	Right	
		Model Number	Model Number	
46	24	T-SLM462421L	T-SLM462421R	628
46	30	T-SLM463021L	T-SLM463021R	678
46	36	T-SLM463621L	T-SLM463621R	721
46	42	T-SLM464221L	T-SLM464221R	763
46	48	T-SLM464821L	T-SLM464821R	805
46	54	T-SLM465421L	T-SLM465421R	847
46	60	T-SLM466021L	T-SLM466021R	958
46	66	T-SLM466621L	T-SLM466621R	1,026
46	72	T-SLM467221L	T-SLM467221R	1,102
46	78	T-SLM467821L	T-SLM467821R	1,178
46	84	T-SLM468421L	T-SLM468421R	1,252
46	90	T-SLM469021L	T-SLM469021R	1,328
50	24	T-SLM502421L	T-SLM502421R	672
50	30	T-SLM503021L	T-SLM503021R	741
50	36	T-SLM503621L	T-SLM503621R	809
50	42	T-SLM504221L	T-SLM504221R	881
50	48	T-SLM504821L	T-SLM504821R	955
50	54	T-SLM505421L	T-SLM505421R	1,032
50	60	T-SLM506021L	T-SLM506021R	1,131
50	66	T-SLM506621L	T-SLM506621R	1,228
50	72	T-SLM507221L	T-SLM507221R	1,327
50	78	T-SLM507821L	T-SLM507821R	1,424
50	84	T-SLM508421L	T-SLM508421R	1,521
50	90	T-SLM509021L	T-SLM509021R	1,618

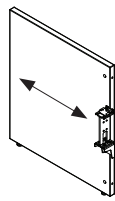

Left Hand Shown

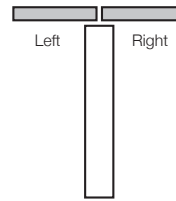

Specify

- Select paint
- Laminate with matching edge

Notes

- Cannot be used freestanding, must be attached to a Beam.
- PowerBeam gallery panels are ordered specific to Beam height.
- Gallery panels add 1 1/8" between or at the end of Beam sections.
- Any gallery panel that extends more than 60" from the Beam must be tied to storage or similar support.

Laminate Gallery Panels – Mid Mount End

25" MID MOUNT END, HORIZONTAL GRAIN PATTERN

H	W	Left	Right	List
		Model Number	Model Number	
29	24	T-SLM292425L	T-SLM292425R	585
29	30	T-SLM293025L	T-SLM293025R	614
29	36	T-SLM293625L	T-SLM293625R	631
29	42	T-SLM294225L	T-SLM294225R	644
29	48	T-SLM294825L	T-SLM294825R	654
29	54	T-SLM295425L	T-SLM295425R	664
29	60	T-SLM296025L	T-SLM296025R	785
29	66	T-SLM296625L	T-SLM296625R	825
29	72	T-SLM297225L	T-SLM297225R	879
29	78	T-SLM297825L	T-SLM297825R	931
29	84	T-SLM298425L	T-SLM298425R	984
29	90	T-SLM299025L	T-SLM299025R	1,037
42	24	T-SLM422425L	T-SLM422425R	629
42	30	T-SLM423025L	T-SLM423025R	678
42	36	T-SLM423625L	T-SLM423625R	721
42	42	T-SLM424225L	T-SLM424225R	762
42	48	T-SLM424825L	T-SLM424825R	806
42	54	T-SLM425425L	T-SLM425425R	847
42	60	T-SLM426025L	T-SLM426025R	957
42	66	T-SLM426625L	T-SLM426625R	1,029
42	72	T-SLM427225L	T-SLM427225R	1,069
42	78	T-SLM427825L	T-SLM427825R	1,110
42	84	T-SLM428425L	T-SLM428425R	1,151
42	90	T-SLM429025L	T-SLM429025R	1,192

25" MID MOUNT END, HORIZONTAL GRAIN PATTERN

H	W	Left	Right	List
		Model Number	Model Number	
46	24	T-SLM462425L	T-SLM462425R	628
46	30	T-SLM463025L	T-SLM463025R	678
46	36	T-SLM463625L	T-SLM463625R	721
46	42	T-SLM464225L	T-SLM464225R	763
46	48	T-SLM464825L	T-SLM464825R	805
46	54	T-SLM465425L	T-SLM465425R	847
46	60	T-SLM466025L	T-SLM466025R	958
46	66	T-SLM466625L	T-SLM466625R	1,026
46	72	T-SLM467225L	T-SLM467225R	1,102
46	78	T-SLM467825L	T-SLM467825R	1,178
46	84	T-SLM468425L	T-SLM468425R	1,252
46	90	T-SLM469025L	T-SLM469025R	1,328
50	24	T-SLM502425L	T-SLM502425R	672
50	30	T-SLM503025L	T-SLM503025R	741
50	36	T-SLM503625L	T-SLM503625R	809
50	42	T-SLM504225L	T-SLM504225R	881
50	48	T-SLM504825L	T-SLM504825R	955
50	54	T-SLM505425L	T-SLM505425R	1,032
50	60	T-SLM506025L	T-SLM506025R	1,131
50	66	T-SLM506625L	T-SLM506625R	1,228
50	72	T-SLM507225L	T-SLM507225R	1,327
50	78	T-SLM507825L	T-SLM507825R	1,424
50	84	T-SLM508425L	T-SLM508425R	1,521
50	90	T-SLM509025L	T-SLM509025R	1,618

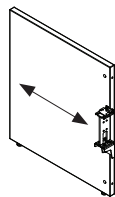

Left Hand Shown

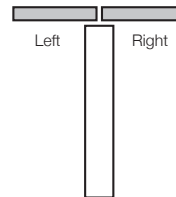

Specify

- Select paint
- Laminate with matching edge

Notes

- Cannot be used freestanding, must be attached to a Beam.
- PowerBeam gallery panels are ordered specific to Beam height.
- Gallery panels add 1 1/8" between or at the end of Beam sections.
- Any gallery panel that extends more than 60" from the Beam must be tied to storage or similar support.

Laminate Gallery Panels – Mid Mount End

25" MID MOUNT END, HORIZONTAL GRAIN PATTERN

H	W	Left	Right	List
		Model Number	Model Number	
58	24	T-SLM582425L	T-SLM582425R	749
58	30	T-SLM583025L	T-SLM583025R	821
58	36	T-SLM583625L	T-SLM583625R	886
58	42	T-SLM584225L	T-SLM584225R	954
58	48	T-SLM584825L	T-SLM584825R	1,007
58	54	T-SLM585425L	T-SLM585425R	1,060
58	60	T-SLM586025L	T-SLM586025R	1,155
58	66	T-SLM586625L	T-SLM586625R	1,250
58	72	T-SLM587225L	T-SLM587225R	1,345
58	78	T-SLM587825L	T-SLM587825R	1,440
58	84	T-SLM588425L	T-SLM588425R	1,535
58	90	T-SLM589025L	T-SLM589025R	1,630

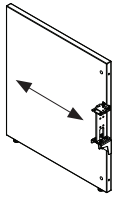

Left Hand Shown

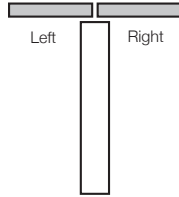

Specify

- Select paint
- Laminate with matching edge

Notes

- Cannot be used freestanding, must be attached to a Beam.
- PowerBeam gallery panels are ordered specific to Beam height.
- Gallery panels add 1 1/8" between or at the end of Beam sections.
- Any gallery panel that extends more than 60" from the Beam must be tied to storage or similar support.

Laminate Gallery Panels – Mid Mount End

29" MID MOUNT END, HORIZONTAL GRAIN PATTERN					29" MID MOUNT END, HORIZONTAL GRAIN PATTERN				
		Left	Right				Left	Right	
H	W	Model Number	Model Number	List	H	W	Model Number	Model Number	List
29	24	T-SLM292429L	T-SLM292429R	585	46	24	T-SLM462429L	T-SLM462429R	628
29	30	T-SLM293029L	T-SLM293029R	614	46	30	T-SLM463029L	T-SLM463029R	678
29	36	T-SLM293629L	T-SLM293629R	631	46	36	T-SLM463629L	T-SLM463629R	721
29	42	T-SLM294229L	T-SLM294229R	644	46	42	T-SLM464229L	T-SLM464229R	763
29	48	T-SLM294829L	T-SLM294829R	654	46	48	T-SLM464829L	T-SLM464829R	805
29	54	T-SLM295429L	T-SLM295429R	664	46	54	T-SLM465429L	T-SLM465429R	847
29	60	T-SLM296029L	T-SLM296029R	785	46	60	T-SLM466029L	T-SLM466029R	958
29	66	T-SLM296629L	T-SLM296629R	825	46	66	T-SLM466629L	T-SLM466629R	1,026
29	72	T-SLM297229L	T-SLM297229R	879	46	72	T-SLM467229L	T-SLM467229R	1,102
29	78	T-SLM297829L	T-SLM297829R	931	46	78	T-SLM467829L	T-SLM467829R	1,178
29	84	T-SLM298429L	T-SLM298429R	984	46	84	T-SLM468429L	T-SLM468429R	1,252
29	90	T-SLM299029L	T-SLM299029R	1,037	46	90	T-SLM469029L	T-SLM469029R	1,328
42	24	T-SLM422429L	T-SLM422429R	629	50	24	T-SLM502429L	T-SLM502429R	672
42	30	T-SLM423029L	T-SLM423029R	678	50	30	T-SLM503029L	T-SLM503029R	741
42	36	T-SLM423629L	T-SLM423629R	721	50	36	T-SLM503629L	T-SLM503629R	809
42	42	T-SLM424229L	T-SLM424229R	762	50	42	T-SLM504229L	T-SLM504229R	881
42	48	T-SLM424829L	T-SLM424829R	806	50	48	T-SLM504829L	T-SLM504829R	955
42	54	T-SLM425429L	T-SLM425429R	847	50	54	T-SLM505429L	T-SLM505429R	1,032
42	60	T-SLM426029L	T-SLM426029R	957	50	60	T-SLM506029L	T-SLM506029R	1,131
42	66	T-SLM426629L	T-SLM426629R	1,029	50	66	T-SLM506629L	T-SLM506629R	1,228
42	72	T-SLM427229L	T-SLM427229R	1,069	50	72	T-SLM507229L	T-SLM507229R	1,327
42	78	T-SLM427829L	T-SLM427829R	1,110	50	78	T-SLM507829L	T-SLM507829R	1,424
42	84	T-SLM428429L	T-SLM428429R	1,151	50	84	T-SLM508429L	T-SLM508429R	1,521
42	90	T-SLM429029L	T-SLM429029R	1,192	50	90	T-SLM509029L	T-SLM509029R	1,618

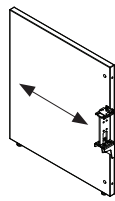

Left Hand Shown

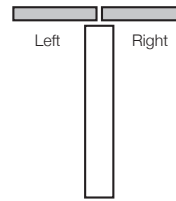

Specify

- Select paint
- Laminate with matching edge

Notes

- Cannot be used freestanding, must be attached to a Beam.
- PowerBeam gallery panels are ordered specific to Beam height.
- Gallery panels add 1 1/8" between or at the end of Beam sections.
- Any gallery panel that extends more than 60" from the Beam must be tied to storage or similar support.

Laminate Gallery Panels – Mid Mount End

29" MID MOUNT END, HORIZONTAL GRAIN PATTERN

H	W	Left	Right	List
		Model Number	Model Number	
58	24	T-SLM582429L	T-SLM582429R	749
58	30	T-SLM583029L	T-SLM583029R	821
58	36	T-SLM583629L	T-SLM583629R	886
58	42	T-SLM584229L	T-SLM584229R	954
58	48	T-SLM584829L	T-SLM584829R	1,007
58	54	T-SLM585429L	T-SLM585429R	1,060
58	60	T-SLM586029L	T-SLM586029R	1,155
58	66	T-SLM586629L	T-SLM586629R	1,250
58	72	T-SLM587229L	T-SLM587229R	1,345
58	78	T-SLM587829L	T-SLM587829R	1,440
58	84	T-SLM588429L	T-SLM588429R	1,535
58	90	T-SLM589029L	T-SLM589029R	1,630

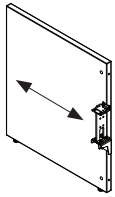

Left Hand Shown

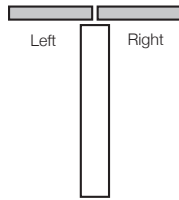

Specify

- Select paint
- Laminate with matching edge

Notes

- Cannot be used freestanding, must be attached to a Beam.
- PowerBeam gallery panels are ordered specific to Beam height.
- Gallery panels add 1 1/8" between or at the end of Beam sections.
- Any gallery panel that extends more than 60" from the Beam must be tied to storage or similar support.

Laminate Gallery Panels – Mid Mount End

21" MID MOUNT END, VERTICAL GRAIN PATTERN				
		Left	Right	
H	W	Model Number	Model Number	List
29	24	T-SLM292421LV	T-SLM292421RV	585
29	30	T-SLM293021LV	T-SLM293021RV	614
29	36	T-SLM293621LV	T-SLM293621RV	631
29	42	T-SLM294221LV	T-SLM294221RV	644
29	48	T-SLM294821LV	T-SLM294821RV	654
29	54	T-SLM295421LV	T-SLM295421RV	664
42	24	T-SLM422421LV	T-SLM422421RV	629
42	30	T-SLM423021LV	T-SLM423021RV	678
42	36	T-SLM423621LV	T-SLM423621RV	721
42	42	T-SLM424221LV	T-SLM424221RV	762
42	48	T-SLM424821LV	T-SLM424821RV	806
42	54	T-SLM425421LV	T-SLM425421RV	847

21" MID MOUNT END, VERTICAL GRAIN PATTERN				
		Left	Right	
H	W	Model Number	Model Number	List
46	24	T-SLM462421LV	T-SLM462421RV	651
46	30	T-SLM463021LV	T-SLM463021RV	710
46	36	T-SLM463621LV	T-SLM463621RV	765
46	42	T-SLM464221LV	T-SLM464221RV	821
46	48	T-SLM464821LV	T-SLM464821RV	881
46	54	T-SLM465421LV	T-SLM465421RV	940
50	24	T-SLM502421LV	T-SLM502421RV	672
50	30	T-SLM503021LV	T-SLM503021RV	741
50	36	T-SLM503621LV	T-SLM503621RV	809
50	42	T-SLM504221LV	T-SLM504221RV	881
50	48	T-SLM504821LV	T-SLM504821RV	955
50	54	T-SLM505421LV	T-SLM505421RV	1,032

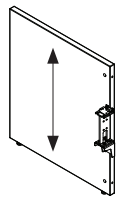

Left Hand Shown

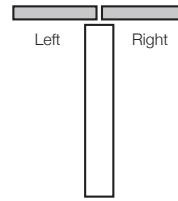

Specify

- Select paint
- Laminate with matching edge

Notes

- Cannot be used freestanding, must be attached to a Beam.
- PowerBeam gallery panels are ordered specific to Beam height.
- Gallery panels add 1 1/8" between or at the end of Beam sections.

Laminate Gallery Panels – Mid Mount End

25" MID MOUNT END, VERTICAL GRAIN PATTERN				
		Left	Right	
H	W	Model Number	Model Number	List
29	24	T-SLM292425LV	T-SLM292425RV	585
29	30	T-SLM293025LV	T-SLM293025RV	614
29	36	T-SLM293625LV	T-SLM293625RV	631
29	42	T-SLM294225LV	T-SLM294225RV	644
29	48	T-SLM294825LV	T-SLM294825RV	654
29	54	T-SLM295425LV	T-SLM295425RV	664
42	24	T-SLM422425LV	T-SLM422425RV	629
42	30	T-SLM423025LV	T-SLM423025RV	678
42	36	T-SLM423625LV	T-SLM423625RV	721
42	42	T-SLM424225LV	T-SLM424225RV	762
42	48	T-SLM424825LV	T-SLM424825RV	806
42	54	T-SLM425425LV	T-SLM425425RV	847
46	24	T-SLM462425LV	T-SLM462425RV	651
46	30	T-SLM463025LV	T-SLM463025RV	710
46	36	T-SLM463625LV	T-SLM463625RV	765
46	42	T-SLM464225LV	T-SLM464225RV	821
46	48	T-SLM464825LV	T-SLM464825RV	881
46	54	T-SLM465425LV	T-SLM465425RV	940

25" MID MOUNT END, VERTICAL GRAIN PATTERN				
		Left	Right	
H	W	Model Number	Model Number	List
50	24	T-SLM502425LV	T-SLM502425RV	672
50	30	T-SLM503025LV	T-SLM503025RV	741
50	36	T-SLM503625LV	T-SLM503625RV	809
50	42	T-SLM504225LV	T-SLM504225RV	881
50	48	T-SLM504825LV	T-SLM504825RV	955
50	54	T-SLM505425LV	T-SLM505425RV	1,032
58	24	T-SLM582425LV	T-SLM582425RV	749
58	30	T-SLM583025LV	T-SLM583025RV	821
58	36	T-SLM583625LV	T-SLM583625RV	886
58	42	T-SLM584225LV	T-SLM584225RV	954
58	48	T-SLM584825LV	T-SLM584825RV	1,007
58	54	T-SLM585425LV	T-SLM585425RV	1,060

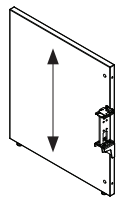

Left Hand Shown

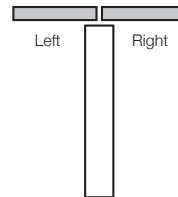

Specify

- Select paint
- Laminate with matching edge

Notes

- Cannot be used freestanding, must be attached to a Beam.
- PowerBeam gallery panels are ordered specific to Beam height.
- Gallery panels add 1 1/8" between or at the end of Beam sections.

Laminate Gallery Panels – Mid Mount End

29" MID MOUNT END, VERTICAL GRAIN PATTERN				
		Left	Right	
H	W	Model Number	Model Number	List
29	24	T-SLM292429LV	T-SLM292429RV	585
29	30	T-SLM293029LV	T-SLM293029RV	614
29	36	T-SLM293629LV	T-SLM293629RV	631
29	42	T-SLM294229LV	T-SLM294229RV	644
29	48	T-SLM294829LV	T-SLM294829RV	654
29	54	T-SLM295429LV	T-SLM295429RV	664
42	24	T-SLM422429LV	T-SLM422429RV	629
42	30	T-SLM423029LV	T-SLM423029RV	678
42	36	T-SLM423629LV	T-SLM423629RV	721
42	42	T-SLM424229LV	T-SLM424229RV	762
42	48	T-SLM424829LV	T-SLM424829RV	806
42	54	T-SLM425429LV	T-SLM425429RV	847
46	24	T-SLM462429LV	T-SLM462429RV	651
46	30	T-SLM463029LV	T-SLM463029RV	710
46	36	T-SLM463629LV	T-SLM463629RV	765
46	42	T-SLM464229LV	T-SLM464229RV	821
46	48	T-SLM464829LV	T-SLM464829RV	881
46	54	T-SLM465429LV	T-SLM465429RV	940

29" MID MOUNT END, VERTICAL GRAIN PATTERN				
		Left	Right	
H	W	Model Number	Model Number	List
50	24	T-SLM502429LV	T-SLM502429RV	672
50	30	T-SLM503029LV	T-SLM503029RV	741
50	36	T-SLM503629LV	T-SLM503629RV	809
50	42	T-SLM504229LV	T-SLM504229RV	881
50	48	T-SLM504829LV	T-SLM504829RV	955
50	54	T-SLM505429LV	T-SLM505429RV	1,032
58	24	T-SLM582429LV	T-SLM582429RV	749
58	30	T-SLM583029LV	T-SLM583029RV	821
58	36	T-SLM583629LV	T-SLM583629RV	886
58	42	T-SLM584229LV	T-SLM584229RV	954
58	48	T-SLM584829LV	T-SLM584829RV	1,007
58	54	T-SLM585429LV	T-SLM585429RV	1,060

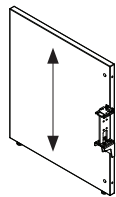

Left Hand Shown

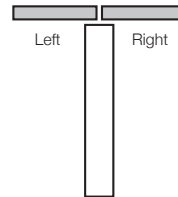

Specify

- Select paint
- Laminate with matching edge

Notes

- Cannot be used freestanding, must be attached to a Beam.
- PowerBeam gallery panels are ordered specific to Beam height.
- Gallery panels add 1 1/8" between or at the end of Beam sections.

Laminate Gallery Panels – Mid Mount End for Wing

21" MID MOUNT END FOR WING, HORIZONTAL GRAIN PATTERN

H	W	Left	Right	List
		Model Number	Model Number	
29	48	T-SLMW294821L	T-SLMW294821R	687
29	54	T-SLMW295421L	T-SLMW295421R	696
29	60	T-SLMW296021L	T-SLMW296021R	818
29	66	T-SLMW296621L	T-SLMW296621R	858
29	72	T-SLMW297221L	T-SLMW297221R	912
29	78	T-SLMW297821L	T-SLMW297821R	965
29	84	T-SLMW298421L	T-SLMW298421R	1,018
29	90	T-SLMW299021L	T-SLMW299021R	1,071
42	48	T-SLMW424821L	T-SLMW424821R	839
42	54	T-SLMW425421L	T-SLMW425421R	880
42	60	T-SLMW426021L	T-SLMW426021R	990
42	66	T-SLMW426621L	T-SLMW426621R	1,060
42	72	T-SLMW427221L	T-SLMW427221R	1,101
42	78	T-SLMW427821L	T-SLMW427821R	1,142
42	84	T-SLMW428421L	T-SLMW428421R	1,184
42	90	T-SLMW429021L	T-SLMW429021R	1,225

21" MID MOUNT END FOR WING, HORIZONTAL GRAIN PATTERN

H	W	Left	Right	List
		Model Number	Model Number	
46	48	T-SLMW464821L	T-SLMW464821R	913
46	54	T-SLMW465421L	T-SLMW465421R	971
46	60	T-SLMW466021L	T-SLMW466021R	1,077
46	66	T-SLMW466621L	T-SLMW466621R	1,161
46	72	T-SLMW467221L	T-SLMW467221R	1,196
46	78	T-SLMW467821L	T-SLMW467821R	1,232
46	84	T-SLMW468421L	T-SLMW468421R	1,266
46	90	T-SLMW469021L	T-SLMW469021R	1,302
50	48	T-SLMW504821L	T-SLMW504821R	989
50	54	T-SLMW505421L	T-SLMW505421R	1,064
50	60	T-SLMW506021L	T-SLMW506021R	1,164
50	66	T-SLMW506621L	T-SLMW506621R	1,262
50	72	T-SLMW507221L	T-SLMW507221R	1,292
50	78	T-SLMW507821L	T-SLMW507821R	1,320
50	84	T-SLMW508421L	T-SLMW508421R	1,349
50	90	T-SLMW509021L	T-SLMW509021R	1,377

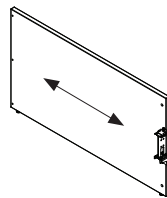

Left Hand Shown

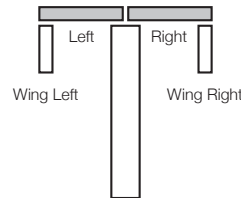

Specify

- Select paint
- Laminate with matching edge

Notes

- Cannot be used freestanding, must be attached to a Beam.
- PowerBeam gallery panels are ordered specific to Beam height.
- Gallery panels add 1 1/8" between or at the end of Beam sections.
- Any gallery panel that extends more than 60" from the Beam must be tied to storage or similar support.

Laminate Gallery Panels – Mid Mount End for Wing

25" MID MOUNT END FOR WING, HORIZONTAL GRAIN PATTERN

H	W	Left	Right	List
		Model Number	Model Number	
29	48	T-SLMW294825L	T-SLMW294825R	687
29	54	T-SLMW295425L	T-SLMW295425R	696
29	60	T-SLMW296025L	T-SLMW296025R	818
29	66	T-SLMW296625L	T-SLMW296625R	858
29	72	T-SLMW297225L	T-SLMW297225R	912
29	78	T-SLMW297825L	T-SLMW297825R	965
29	84	T-SLMW298425L	T-SLMW298425R	1,018
29	90	T-SLMW299025L	T-SLMW299025R	1,071
42	48	T-SLMW424825L	T-SLMW424825R	839
42	54	T-SLMW425425L	T-SLMW425425R	880
42	60	T-SLMW426025L	T-SLMW426025R	990
42	66	T-SLMW426625L	T-SLMW426625R	1,060
42	72	T-SLMW427225L	T-SLMW427225R	1,101
42	78	T-SLMW427825L	T-SLMW427825R	1,142
42	84	T-SLMW428425L	T-SLMW428425R	1,184
42	90	T-SLMW429025L	T-SLMW429025R	1,225
46	48	T-SLMW464825L	T-SLMW464825R	913
46	54	T-SLMW465425L	T-SLMW465425R	971
46	60	T-SLMW466025L	T-SLMW466025R	1,077
46	66	T-SLMW466625L	T-SLMW466625R	1,161
46	72	T-SLMW467225L	T-SLMW467225R	1,196
46	78	T-SLMW467825L	T-SLMW467825R	1,232
46	84	T-SLMW468425L	T-SLMW468425R	1,266
46	90	T-SLMW469025L	T-SLMW469025R	1,302

25" MID MOUNT END FOR WING, HORIZONTAL GRAIN PATTERN

H	W	Left	Right	List
		Model Number	Model Number	
50	48	T-SLMW504825L	T-SLMW504825R	989
50	54	T-SLMW505425L	T-SLMW505425R	1,064
50	60	T-SLMW506025L	T-SLMW506025R	1,164
50	66	T-SLMW506625L	T-SLMW506625R	1,262
50	72	T-SLMW507225L	T-SLMW507225R	1,292
50	78	T-SLMW507825L	T-SLMW507825R	1,320
50	84	T-SLMW508425L	T-SLMW508425R	1,349
50	90	T-SLMW509025L	T-SLMW509025R	1,377
58	48	T-SLMW584825L	T-SLMW584825R	1,041
58	54	T-SLMW585425L	T-SLMW585425R	1,093
58	60	T-SLMW586025L	T-SLMW586025R	1,188
58	66	T-SLMW586625L	T-SLMW586625R	1,282
58	72	T-SLMW587225L	T-SLMW587225R	1,376
58	78	T-SLMW587825L	T-SLMW587825R	1,471
58	84	T-SLMW588425L	T-SLMW588425R	1,566
58	90	T-SLMW589025L	T-SLMW589025R	1,660

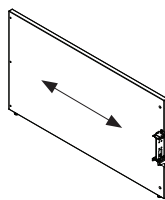

Left Hand Shown

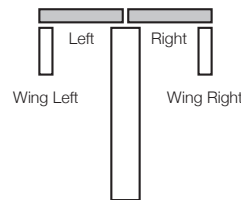

Specify

- Select paint
- Laminate with matching edge

Notes

- Cannot be used freestanding, must be attached to a Beam.
- PowerBeam gallery panels are ordered specific to Beam height.
- Gallery panels add 1 1/8" between or at the end of Beam sections.
- Any gallery panel that extends more than 60" from the Beam must be tied to storage or similar support.

Laminate Gallery Panels – Mid Mount End for Wing

29" MID MOUNT END FOR WING, HORIZONTAL GRAIN PATTERN

H	W	Left	Right	List
		Model Number	Model Number	
29	48	T-SLMW294829L	T-SLMW294829R	687
29	54	T-SLMW295429L	T-SLMW295429R	696
29	60	T-SLMW296029L	T-SLMW296029R	818
29	66	T-SLMW296629L	T-SLMW296629R	858
29	72	T-SLMW297229L	T-SLMW297229R	912
29	78	T-SLMW297829L	T-SLMW297829R	965
29	84	T-SLMW298429L	T-SLMW298429R	1,018
29	90	T-SLMW299029L	T-SLMW299029R	1,071
42	48	T-SLMW424829L	T-SLMW424829R	839
42	54	T-SLMW425429L	T-SLMW425429R	880
42	60	T-SLMW426029L	T-SLMW426029R	990
42	66	T-SLMW426629L	T-SLMW426629R	1,060
42	72	T-SLMW427229L	T-SLMW427229R	1,101
42	78	T-SLMW427829L	T-SLMW427829R	1,142
42	84	T-SLMW428429L	T-SLMW428429R	1,184
42	90	T-SLMW429029L	T-SLMW429029R	1,225
46	48	T-SLMW464829L	T-SLMW464829R	913
46	54	T-SLMW465429L	T-SLMW465429R	971
46	60	T-SLMW466029L	T-SLMW466029R	1,077
46	66	T-SLMW466629L	T-SLMW466629R	1,161
46	72	T-SLMW467229L	T-SLMW467229R	1,196
46	78	T-SLMW467829L	T-SLMW467829R	1,232
46	84	T-SLMW468429L	T-SLMW468429R	1,266
46	90	T-SLMW469029L	T-SLMW469029R	1,302

29" MID MOUNT END FOR WING, HORIZONTAL GRAIN PATTERN

H	W	Left	Right	List
		Model Number	Model Number	
50	48	T-SLMW504829L	T-SLMW504829R	989
50	54	T-SLMW505429L	T-SLMW505429R	1,064
50	60	T-SLMW506029L	T-SLMW506029R	1,164
50	66	T-SLMW506629L	T-SLMW506629R	1,262
50	72	T-SLMW507229L	T-SLMW507229R	1,292
50	78	T-SLMW507829L	T-SLMW507829R	1,320
50	84	T-SLMW508429L	T-SLMW508429R	1,349
50	90	T-SLMW509029L	T-SLMW509029R	1,377
58	48	T-SLMW584829L	T-SLMW584829R	1,041
58	54	T-SLMW585429L	T-SLMW585429R	1,093
58	60	T-SLMW586029L	T-SLMW586029R	1,188
58	66	T-SLMW586629L	T-SLMW586629R	1,282
58	72	T-SLMW587229L	T-SLMW587229R	1,376
58	78	T-SLMW587829L	T-SLMW587829R	1,471
58	84	T-SLMW588429L	T-SLMW588429R	1,566
58	90	T-SLMW589029L	T-SLMW589029R	1,660

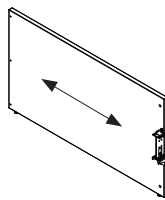

Left Hand Shown

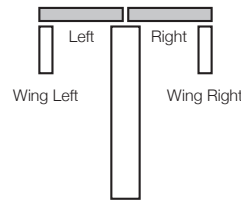

Specify

- Select paint
- Laminate with matching edge

Notes

- Cannot be used freestanding, must be attached to a Beam.
- PowerBeam gallery panels are ordered specific to Beam height.
- Gallery panels add 1 1/8" between or at the end of Beam sections.
- Any gallery panel that extends more than 60" from the Beam must be tied to storage or similar support.

Laminate Gallery Panels – Mid Mount End for Wing

21" MID MOUNT END FOR WING, VERTICAL GRAIN PATTERN

H	W	Left	Right	List
		Model Number	Model Number	
29	48	T-SLMW294821LV	T-SLMW294821RV	687
29	54	T-SLMW295421LV	T-SLMW295421RV	696
42	48	T-SLMW424821LV	T-SLMW424821RV	839
42	54	T-SLMW425421LV	T-SLMW425421RV	880
46	48	T-SLMW464821LV	T-SLMW464821RV	913
46	54	T-SLMW465421LV	T-SLMW465421RV	971
50	48	T-SLMW504821LV	T-SLMW504821RV	989
50	54	T-SLMW505421LV	T-SLMW505421RV	1,064

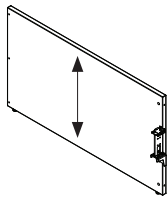

Left Hand Shown

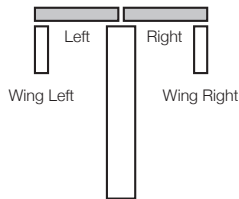

Specify

- Select paint
- Laminate with matching edge

Notes

- Cannot be used freestanding, must be attached to a Beam.
- PowerBeam gallery panels are ordered specific to Beam height.
- Gallery panels add 1 1/8" between or at the end of Beam sections.

Laminate Gallery Panels – Mid Mount End for Wing

25" MID MOUNT END FOR WING, VERTICAL GRAIN PATTERN

H	W	Left	Right	List
		Model Number	Model Number	
29	48	T-SLMW294825LV	T-SLMW294825RV	687
29	54	T-SLMW295425LV	T-SLMW295425RV	696
42	48	T-SLMW424825LV	T-SLMW424825RV	839
42	54	T-SLMW425425LV	T-SLMW425425RV	880
46	48	T-SLMW464825LV	T-SLMW464825RV	913
46	54	T-SLMW465425LV	T-SLMW465425RV	971
50	48	T-SLMW504825LV	T-SLMW504825RV	989
50	54	T-SLMW505425LV	T-SLMW505425RV	1,064
58	48	T-SLMW584825LV	T-SLMW584825RV	1,041
58	54	T-SLMW585425LV	T-SLMW585425RV	1,093

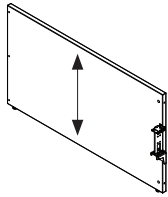

Left Hand Shown

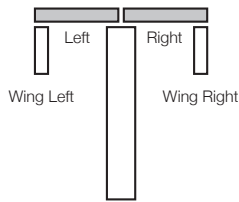

Specify

- Select paint
- Laminate with matching edge

Notes

- Cannot be used freestanding, must be attached to a Beam.
- PowerBeam gallery panels are ordered specific to Beam height.
- Gallery panels add 1 1/8" between or at the end of Beam sections.

Laminate Gallery Panels – Mid Mount End for Wing

29" MID MOUNT END FOR WING, VERTICAL GRAIN PATTERN

H	W	Left	Right	List
		Model Number	Model Number	
29	48	T-SLMW294829LV	T-SLMW294829RV	687
29	54	T-SLMW295429LV	T-SLMW295429RV	696
42	48	T-SLMW424829LV	T-SLMW424829RV	839
42	54	T-SLMW425429LV	T-SLMW425429RV	880
46	48	T-SLMW464829LV	T-SLMW464829RV	913
46	54	T-SLMW465429LV	T-SLMW465429RV	971
50	48	T-SLMW504829LV	T-SLMW504829RV	989
50	54	T-SLMW505429LV	T-SLMW505429RV	1,064
58	48	T-SLMW584829LV	T-SLMW584829RV	1,041
58	54	T-SLMW585429LV	T-SLMW585429RV	1,093

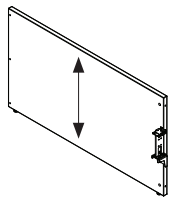

Left Hand Shown

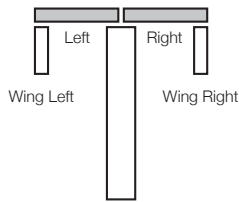

Specify

- Select paint
- Laminate with matching edge

Notes

- Cannot be used freestanding, must be attached to a Beam.
- PowerBeam gallery panels are ordered specific to Beam height.
- Gallery panels add 1 1/8" between or at the end of Beam sections.

Laminate Gallery Panels – Beam Mount Single Spine

21" BEAM MOUNT SINGLE SPINE, HORIZONTAL GRAIN PATTERN

H	W	Model Number	List
29	24	T-SLGP292421	585
29	30	T-SLGP293021	614
29	36	T-SLGP293621	631
29	42	T-SLGP294221	644
29	48	T-SLGP294821	654
29	54	T-SLGP295421	664
29	60	T-SLGP296021	785
29	66	T-SLGP296621	825
29	72	T-SLGP297221	879
29	78	T-SLGP297821	931
29	84	T-SLGP298421	984
29	90	T-SLGP299021	1,037
42	24	T-SLGP422421	629
42	30	T-SLGP423021	678
42	36	T-SLGP423621	721
42	42	T-SLGP424221	762
42	48	T-SLGP424821	806
42	54	T-SLGP425421	847
42	60	T-SLGP426021	957
42	66	T-SLGP426621	1,029
42	72	T-SLGP427221	1,069
42	78	T-SLGP427821	1,110
42	84	T-SLGP428421	1,151
42	90	T-SLGP429021	1,192

21" BEAM MOUNT SINGLE SPINE, HORIZONTAL GRAIN PATTERN

H	W	Model Number	List
46	24	T-SLGP462421	651
46	30	T-SLGP463021	710
46	36	T-SLGP463621	765
46	42	T-SLGP464221	821
46	48	T-SLGP464821	881
46	54	T-SLGP465421	940
46	60	T-SLGP466021	1,044
46	66	T-SLGP466621	1,128
46	72	T-SLGP467221	1,164
46	78	T-SLGP467821	1,199
46	84	T-SLGP468421	1,234
46	90	T-SLGP469021	1,268
50	24	T-SLGP502421	672
50	30	T-SLGP503021	741
50	36	T-SLGP503621	809
50	42	T-SLGP504221	881
50	48	T-SLGP504821	955
50	54	T-SLGP505421	1,032
50	60	T-SLGP506021	1,131
50	66	T-SLGP506621	1,228
50	72	T-SLGP507221	1,259
50	78	T-SLGP507821	1,288
50	84	T-SLGP508421	1,317
50	90	T-SLGP509021	1,345

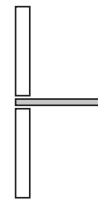
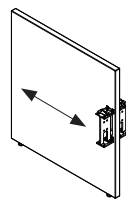

Specify

Notes

- Laminate with matching edge
- Cannot be used freestanding, must be attached to a Beam.
- PowerBeam gallery panels are ordered specific to Beam height.
- Gallery panels add 1 1/8" between or at the end of Beam sections.
- Any gallery panel that extends more than 60" from the Beam must be tied to storage or similar support.

Laminate Gallery Panels – Beam Mount Single Spine

25" BEAM MOUNT SINGLE SPINE, HORIZONTAL GRAIN PATTERN

H	W	Model Number	List
29	24	T-SLGP292425	585
29	30	T-SLGP293025	614
29	36	T-SLGP293625	631
29	42	T-SLGP294225	644
29	48	T-SLGP294825	654
29	54	T-SLGP295425	664
29	60	T-SLGP296025	785
29	66	T-SLGP296625	825
29	72	T-SLGP297225	879
29	78	T-SLGP297825	931
29	84	T-SLGP298425	984
29	90	T-SLGP299025	1,037
42	24	T-SLGP422425	629
42	30	T-SLGP423025	678
42	36	T-SLGP423625	721
42	42	T-SLGP424225	762
42	48	T-SLGP424825	806
42	54	T-SLGP425425	847
42	60	T-SLGP426025	957
42	66	T-SLGP426625	1,029
42	72	T-SLGP427225	1,069
42	78	T-SLGP427825	1,110
42	84	T-SLGP428425	1,151
42	90	T-SLGP429025	1,192

25" BEAM MOUNT SINGLE SPINE, HORIZONTAL GRAIN PATTERN

H	W	Model Number	List
46	24	T-SLGP462425	651
46	30	T-SLGP463025	710
46	36	T-SLGP463625	765
46	42	T-SLGP464225	821
46	48	T-SLGP464825	881
46	54	T-SLGP465425	940
46	60	T-SLGP466025	1,044
46	66	T-SLGP466625	1,128
46	72	T-SLGP467225	1,164
46	78	T-SLGP467825	1,199
46	84	T-SLGP468425	1,234
46	90	T-SLGP469025	1,268
50	24	T-SLGP502425	672
50	30	T-SLGP503025	741
50	36	T-SLGP503625	809
50	42	T-SLGP504225	881
50	48	T-SLGP504825	955
50	54	T-SLGP505425	1,032
50	60	T-SLGP506025	1,131
50	66	T-SLGP506625	1,228
50	72	T-SLGP507225	1,259
50	78	T-SLGP507825	1,288
50	84	T-SLGP508425	1,317
50	90	T-SLGP509025	1,345

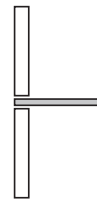
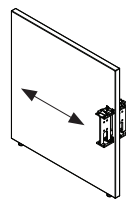

Specify

- Laminate with matching edge

Notes

- Cannot be used freestanding, must be attached to a Beam.
- PowerBeam gallery panels are ordered specific to Beam height.
- Gallery panels add 1 1/8" between or at the end of Beam sections.
- Any gallery panel that extends more than 60" from the Beam must be tied to storage or similar support.

Laminate Gallery Panels – Beam Mount Single Spine

25" BEAM MOUNT SINGLE SPINE, HORIZONTAL GRAIN PATTERN

H	W	Model Number	List
58	24	T-SLGP582425	749
58	30	T-SLGP583025	821
58	36	T-SLGP583625	886
58	42	T-SLGP584225	954
58	48	T-SLGP584825	1,007
58	54	T-SLGP585425	1,060
58	60	T-SLGP586025	1,155
58	66	T-SLGP586625	1,250
58	72	T-SLGP587225	1,344
58	78	T-SLGP587825	1,438
58	84	T-SLGP588425	1,533
58	90	T-SLGP589025	1,628

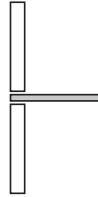
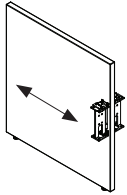

Specify

- Laminate with matching edge

Notes

- Cannot be used freestanding, must be attached to a Beam.
- PowerBeam gallery panels are ordered specific to Beam height.
- Gallery panels add 1 1/8" between or at the end of Beam sections.
- Any gallery panel that extends more than 60" from the Beam must be tied to storage or similar support.

Laminate Gallery Panels – Beam Mount Single Spine

29" BEAM MOUNT SINGLE SPINE, HORIZONTAL GRAIN PATTERN

H	W	Model Number	List
29	24	T-SLGP292429	585
29	30	T-SLGP293029	614
29	36	T-SLGP293629	631
29	42	T-SLGP294229	644
29	48	T-SLGP294829	654
29	54	T-SLGP295429	664
29	60	T-SLGP296029	785
29	66	T-SLGP296629	825
29	72	T-SLGP297229	879
29	78	T-SLGP297829	931
29	84	T-SLGP298429	984
29	90	T-SLGP299029	1,037
42	24	T-SLGP422429	629
42	30	T-SLGP423029	678
42	36	T-SLGP423629	721
42	42	T-SLGP424229	762
42	48	T-SLGP424829	806
42	54	T-SLGP425429	847
42	60	T-SLGP426029	957
42	66	T-SLGP426629	1,029
42	72	T-SLGP427229	1,069
42	78	T-SLGP427829	1,110
42	84	T-SLGP428429	1,151
42	90	T-SLGP429029	1,192

29" BEAM MOUNT SINGLE SPINE, HORIZONTAL GRAIN PATTERN

H	W	Model Number	List
46	24	T-SLGP462429	651
46	30	T-SLGP463029	710
46	36	T-SLGP463629	765
46	42	T-SLGP464229	821
46	48	T-SLGP464829	881
46	54	T-SLGP465429	940
46	60	T-SLGP466029	1,044
46	66	T-SLGP466629	1,128
46	72	T-SLGP467229	1,164
46	78	T-SLGP467829	1,199
46	84	T-SLGP468429	1,234
46	90	T-SLGP469029	1,268
50	24	T-SLGP502429	672
50	30	T-SLGP503029	741
50	36	T-SLGP503629	809
50	42	T-SLGP504229	881
50	48	T-SLGP504829	955
50	54	T-SLGP505429	1,032
50	60	T-SLGP506029	1,131
50	66	T-SLGP506629	1,228
50	72	T-SLGP507229	1,259
50	78	T-SLGP507829	1,288
50	84	T-SLGP508429	1,317
50	90	T-SLGP509029	1,345

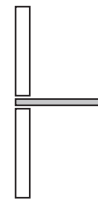
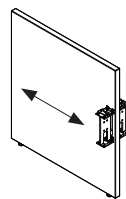

Specify

- Laminate with matching edge

Notes

- Cannot be used freestanding, must be attached to a Beam.
- PowerBeam gallery panels are ordered specific to Beam height.
- Gallery panels add 1 1/8" between or at the end of Beam sections.
- Any gallery panel that extends more than 60" from the Beam must be tied to storage or similar support.

Laminate Gallery Panels – Beam Mount Single Spine

29" BEAM MOUNT SINGLE SPINE, HORIZONTAL GRAIN PATTERN

H	W	Model Number	List
58	24	T-SLGP582429	749
58	30	T-SLGP583029	821
58	36	T-SLGP583629	886
58	42	T-SLGP584229	954
58	48	T-SLGP584829	1,007
58	54	T-SLGP585429	1,060
58	60	T-SLGP586029	1,155
58	66	T-SLGP586629	1,250
58	72	T-SLGP587229	1,344
58	78	T-SLGP587829	1,438
58	84	T-SLGP588429	1,533
58	90	T-SLGP589029	1,628

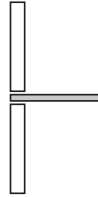
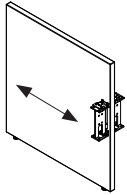

Specify

- Laminate with matching edge

Notes

- Cannot be used freestanding, must be attached to a Beam.
- PowerBeam gallery panels are ordered specific to Beam height.
- Gallery panels add 1 1/8" between or at the end of Beam sections.
- Any gallery panel that extends more than 60" from the Beam must be tied to storage or similar support.

Laminate Gallery Panels – Beam Mount Single Spine

21" BEAM MOUNT SINGLE SPINE, VERTICAL GRAIN PATTERN

H	W	Model Number	List
29	24	T-SLGP292421V	585
29	30	T-SLGP293021V	614
29	36	T-SLGP293621V	631
29	42	T-SLGP294221V	644
29	48	T-SLGP294821V	654
29	54	T-SLGP295421V	664
42	24	T-SLGP422421V	629
42	30	T-SLGP423021V	678
42	36	T-SLGP423621V	721
42	42	T-SLGP424221V	762
42	48	T-SLGP424821V	806
42	54	T-SLGP425421V	847

21" BEAM MOUNT SINGLE SPINE, VERTICAL GRAIN PATTERN

H	W	Model Number	List
46	24	T-SLGP462421V	651
46	30	T-SLGP463021V	710
46	36	T-SLGP463621V	765
46	42	T-SLGP464221V	821
46	48	T-SLGP464821V	881
46	54	T-SLGP465421V	940
50	24	T-SLGP502421V	672
50	30	T-SLGP503021V	741
50	36	T-SLGP503621V	809
50	42	T-SLGP504221V	881
50	48	T-SLGP504821V	955
50	54	T-SLGP505421V	1,032

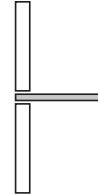
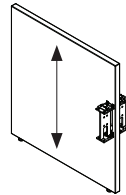

Specify

Notes

• Laminate with matching edge

- Cannot be used freestanding, must be attached to a Beam.
- PowerBeam gallery panels are ordered specific to Beam height.
- Gallery panels add 1 1/8" between or at the end of Beam sections.

Laminate Gallery Panels – Beam Mount Single Spine

25" BEAM MOUNT SINGLE SPINE, VERTICAL GRAIN PATTERN

H	W	Model Number	List
29	24	T-SLGP292425V	585
29	30	T-SLGP293025V	614
29	36	T-SLGP293625V	631
29	42	T-SLGP294225V	644
29	48	T-SLGP294825V	654
29	54	T-SLGP295425V	664
42	24	T-SLGP422425V	629
42	30	T-SLGP423025V	678
42	36	T-SLGP423625V	721
42	42	T-SLGP424225V	762
42	48	T-SLGP424825V	806
42	54	T-SLGP425425V	847
46	24	T-SLGP462425V	651
46	30	T-SLGP463025V	710
46	36	T-SLGP463625V	765
46	42	T-SLGP464225V	821
46	48	T-SLGP464825V	881
46	54	T-SLGP465425V	940

25" BEAM MOUNT SINGLE SPINE, VERTICAL GRAIN PATTERN

H	W	Model Number	List
50	24	T-SLGP502425V	672
50	30	T-SLGP503025V	741
50	36	T-SLGP503625V	809
50	42	T-SLGP504225V	881
50	48	T-SLGP504825V	955
50	54	T-SLGP505425V	1,032
58	24	T-SLGP582425V	749
58	30	T-SLGP583025V	821
58	36	T-SLGP583625V	886
58	42	T-SLGP584225V	954
58	48	T-SLGP584825V	1,007
58	54	T-SLGP585425V	1,060

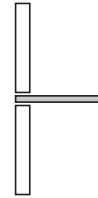
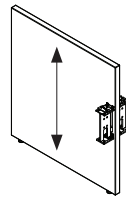

Specify

- Laminate with matching edge

Notes

- Cannot be used freestanding, must be attached to a Beam.
- PowerBeam gallery panels are ordered specific to Beam height.
- Gallery panels add 1 1/8" between or at the end of Beam sections.

Laminate Gallery Panels – Beam Mount Single Spine

29" BEAM MOUNT SINGLE SPINE, VERTICAL GRAIN PATTERN

H	W	Model Number	List
29	24	T-SLGP292429V	585
29	30	T-SLGP293029V	614
29	36	T-SLGP293629V	631
29	42	T-SLGP294229V	644
29	48	T-SLGP294829V	654
29	54	T-SLGP295429V	664
42	24	T-SLGP422429V	629
42	30	T-SLGP423029V	678
42	36	T-SLGP423629V	721
42	42	T-SLGP424229V	762
42	48	T-SLGP424829V	806
42	54	T-SLGP425429V	847
46	24	T-SLGP462429V	651
46	30	T-SLGP463029V	710
46	36	T-SLGP463629V	765
46	42	T-SLGP464229V	821
46	48	T-SLGP464829V	881
46	54	T-SLGP465429V	940

29" BEAM MOUNT SINGLE SPINE, VERTICAL GRAIN PATTERN

H	W	Model Number	List
50	24	T-SLGP502429V	672
50	30	T-SLGP503029V	741
50	36	T-SLGP503629V	809
50	42	T-SLGP504229V	881
50	48	T-SLGP504829V	955
50	54	T-SLGP505429V	1,032
58	24	T-SLGP582429V	749
58	30	T-SLGP583029V	821
58	36	T-SLGP583629V	886
58	42	T-SLGP584229V	954
58	48	T-SLGP584829V	1,007
58	54	T-SLGP585429V	1,060

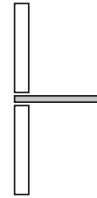
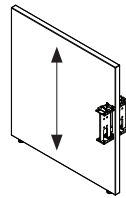

Specify

- Laminate with matching edge

Notes

- Cannot be used freestanding, must be attached to a Beam.
- PowerBeam gallery panels are ordered specific to Beam height.
- Gallery panels add 1 1/8" between or at the end of Beam sections.

Laminate Gallery Panels – Beam Mount Double Spine

21" BEAM MOUNT DOUBLE SPINE, HORIZONTAL GRAIN PATTERN

H	W	Model Number	List
29	48	T-SLGPD294821	687
29	54	T-SLGPD295421	696
29	60	T-SLGPD296021	818
29	66	T-SLGPD296621	858
29	72	T-SLGPD297221	912
29	78	T-SLGPD297821	965
29	84	T-SLGPD298421	1,018
29	90	T-SLGPD299021	1,071
42	48	T-SLGPD424821	839
42	54	T-SLGPD425421	880
42	60	T-SLGPD426021	990
42	66	T-SLGPD426621	1,060
42	72	T-SLGPD427221	1,101
42	78	T-SLGPD427821	1,142
42	84	T-SLGPD428421	1,184
42	90	T-SLGPD429021	1,225

21" BEAM MOUNT DOUBLE SPINE, HORIZONTAL GRAIN PATTERN

H	W	Model Number	List
46	48	T-SLGPD464821	913
46	54	T-SLGPD465421	971
46	60	T-SLGPD466021	1,077
46	66	T-SLGPD466621	1,161
46	72	T-SLGPD467221	1,196
46	78	T-SLGPD467821	1,232
46	84	T-SLGPD468421	1,266
46	90	T-SLGPD469021	1,302
50	48	T-SLGPD504821	989
50	54	T-SLGPD505421	1,064
50	60	T-SLGPD506021	1,164
50	66	T-SLGPD506621	1,262
50	72	T-SLGPD507221	1,292
50	78	T-SLGPD507821	1,320
50	84	T-SLGPD508421	1,349
50	90	T-SLGPD509021	1,377

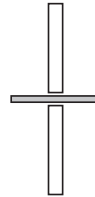
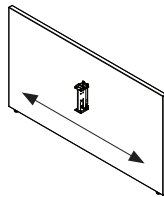

Specify

- Laminate with matching edge

Notes

- Cannot be used freestanding, must be attached to a Beam.
- PowerBeam gallery panels are ordered specific to Beam height.
- Gallery panels add 1 1/8" between or at the end of Beam sections.
- Any gallery panel that extends more than 60" from the Beam must be tied to storage or similar support.

Laminate Gallery Panels – Beam Mount Double Spine

25" BEAM MOUNT DOUBLE SPINE, HORIZONTAL GRAIN PATTERN

H	W	Model Number	List
29	48	T-SLGPD294825	687
29	54	T-SLGPD295425	696
29	60	T-SLGPD296025	818
29	66	T-SLGPD296625	858
29	72	T-SLGPD297225	912
29	78	T-SLGPD297825	965
29	84	T-SLGPD298425	1,018
29	90	T-SLGPD299025	1,071
42	48	T-SLGPD424825	839
42	54	T-SLGPD425425	880
42	60	T-SLGPD426025	990
42	66	T-SLGPD426625	1,060
42	72	T-SLGPD427225	1,101
42	78	T-SLGPD427825	1,142
42	84	T-SLGPD428425	1,184
42	90	T-SLGPD429025	1,225
46	48	T-SLGPD464825	913
46	54	T-SLGPD465425	971
46	60	T-SLGPD466025	1,077
46	66	T-SLGPD466625	1,161
46	72	T-SLGPD467225	1,196
46	78	T-SLGPD467825	1,232
46	84	T-SLGPD468425	1,266
46	90	T-SLGPD469025	1,302

25" BEAM MOUNT DOUBLE SPINE, HORIZONTAL GRAIN PATTERN

H	W	Model Number	List
50	48	T-SLGPD504825	989
50	54	T-SLGPD505425	1,064
50	60	T-SLGPD506025	1,164
50	66	T-SLGPD506625	1,262
50	72	T-SLGPD507225	1,292
50	78	T-SLGPD507825	1,320
50	84	T-SLGPD508425	1,349
50	90	T-SLGPD509025	1,377
58	48	T-SLGPD584825	1,041
58	54	T-SLGPD585425	1,093
58	60	T-SLGPD586025	1,188
58	66	T-SLGPD586625	1,282
58	72	T-SLGPD587225	1,376
58	78	T-SLGPD587825	1,471
58	84	T-SLGPD588425	1,566
58	90	T-SLGPD589025	1,660

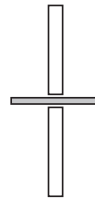
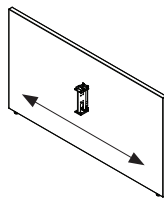

Specify

- Laminate with matching edge

Notes

- Cannot be used freestanding, must be attached to a Beam.
- PowerBeam gallery panels are ordered specific to Beam height.
- Gallery panels add 1 1/8" between or at the end of Beam sections.
- Any gallery panel that extends more than 60" from the Beam must be tied to storage or similar support.

Laminate Gallery Panels – Beam Mount Double Spine

29" BEAM MOUNT DOUBLE SPINE, HORIZONTAL GRAIN PATTERN

H	W	Model Number	List
29	48	T-SLGPD294829	687
29	54	T-SLGPD295429	696
29	60	T-SLGPD296029	818
29	66	T-SLGPD296629	858
29	72	T-SLGPD297229	912
29	78	T-SLGPD297829	965
29	84	T-SLGPD298429	1,018
29	90	T-SLGPD299029	1,071
42	48	T-SLGPD424829	839
42	54	T-SLGPD425429	880
42	60	T-SLGPD426029	990
42	66	T-SLGPD426629	1,060
42	72	T-SLGPD427229	1,101
42	78	T-SLGPD427829	1,142
42	84	T-SLGPD428429	1,184
42	90	T-SLGPD429029	1,225
46	48	T-SLGPD464829	913
46	54	T-SLGPD465429	971
46	60	T-SLGPD466029	1,077
46	66	T-SLGPD466629	1,161
46	72	T-SLGPD467229	1,196
46	78	T-SLGPD467829	1,232
46	84	T-SLGPD468429	1,266
46	90	T-SLGPD469029	1,302

29" BEAM MOUNT DOUBLE SPINE, HORIZONTAL GRAIN PATTERN

H	W	Model Number	List
50	48	T-SLGPD504829	989
50	54	T-SLGPD505429	1,064
50	60	T-SLGPD506029	1,164
50	66	T-SLGPD506629	1,262
50	72	T-SLGPD507229	1,292
50	78	T-SLGPD507829	1,320
50	84	T-SLGPD508429	1,349
50	90	T-SLGPD509029	1,377
58	48	T-SLGPD584829	1,041
58	54	T-SLGPD585429	1,093
58	60	T-SLGPD586029	1,188
58	66	T-SLGPD586629	1,282
58	72	T-SLGPD587229	1,376
58	78	T-SLGPD587829	1,471
58	84	T-SLGPD588429	1,566
58	90	T-SLGPD589029	1,660

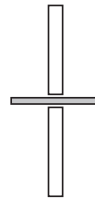
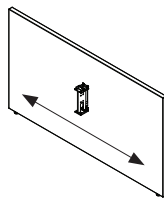

Specify

- Laminate with matching edge

Notes

- Cannot be used freestanding, must be attached to a Beam.
- PowerBeam gallery panels are ordered specific to Beam height.
- Gallery panels add 1 1/8" between or at the end of Beam sections.
- Any gallery panel that extends more than 60" from the Beam must be tied to storage or similar support.

Laminate Gallery Panels – Beam Mount Double Spine

21" BEAM MOUNT DOUBLE SPINE, VERTICAL GRAIN PATTERN

H	W	Model Number	List
29	48	T-SLGPD294821V	687
29	54	T-SLGPD295421V	696
42	48	T-SLGPD424821V	839
42	54	T-SLGPD425421V	880
46	48	T-SLGPD464821V	913
46	54	T-SLGPD465421V	971
50	48	T-SLGPD504821V	989
50	54	T-SLGPD505421V	1,064

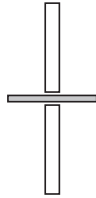
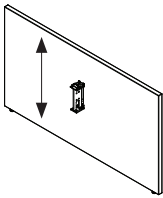

Specify

- Laminate with matching edge

Notes

- Cannot be used freestanding, must be attached to a Beam.
- PowerBeam gallery panels are ordered specific to Beam height.
- Gallery panels add 1 1/8" between or at the end of Beam sections.

Laminate Gallery Panels – Beam Mount Double Spine

25" BEAM MOUNT DOUBLE SPINE, VERTICAL GRAIN PATTERN

H	W	Model Number	List
29	48	T-SLGPD294825V	687
29	54	T-SLGPD295425V	696
42	48	T-SLGPD424825V	839
42	54	T-SLGPD425425V	880
46	48	T-SLGPD464825V	913
46	54	T-SLGPD465425V	971
50	48	T-SLGPD504825V	989
50	54	T-SLGPD505425V	1,064
58	48	T-SLGPD584825V	1,041
58	54	T-SLGPD585425V	1,093

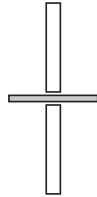
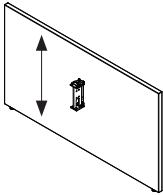

Specify

- Laminate with matching edge

Notes

- Cannot be used freestanding, must be attached to a Beam.
- PowerBeam gallery panels are ordered specific to Beam height.
- Gallery panels add 1 1/8" between or at the end of Beam sections.

Laminate Gallery Panels – Beam Mount Double Spine

29" BEAM MOUNT DOUBLE SPINE, VERTICAL GRAIN PATTERN

H	W	Model Number	List
29	48	T-SLGPD294829V	687
29	54	T-SLGPD295429V	696
42	48	T-SLGPD424829V	839
42	54	T-SLGPD425429V	880
46	48	T-SLGPD464829V	913
46	54	T-SLGPD465429V	971
50	48	T-SLGPD504829V	989
50	54	T-SLGPD505429V	1,064
58	48	T-SLGPD584829V	1,041
58	54	T-SLGPD585429V	1,093

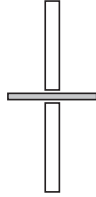
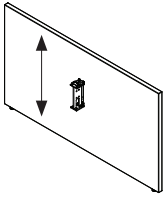

Specify

- Laminate with matching edge

Notes

- Cannot be used freestanding, must be attached to a Beam.
- PowerBeam gallery panels are ordered specific to Beam height.
- Gallery panels add 1 1/8" between or at the end of Beam sections.

Laminate Gallery Panels – Beam Mount Single Spine for Wing

21" BEAM MOUNT SINGLE SPINE FOR WING, HORIZONTAL GRAIN PATTERN				
H	W	Left	Right	List
		Model Number	Model Number	
29	48	T-SGPW294821L	T-SGPW294821R	720
29	54	T-SGPW295421L	T-SGPW295421R	728
29	60	T-SGPW296021L	T-SGPW296021R	850
29	66	T-SGPW296621L	T-SGPW296621R	890
29	72	T-SGPW297221L	T-SGPW297221R	943
29	78	T-SGPW297821L	T-SGPW297821R	997
29	84	T-SGPW298421L	T-SGPW298421R	1,049
29	90	T-SGPW299021L	T-SGPW299021R	1,103
42	48	T-SGPW424821L	T-SGPW424821R	871
42	54	T-SGPW425421L	T-SGPW425421R	913
42	60	T-SGPW426021L	T-SGPW426021R	1,022
42	66	T-SGPW426621L	T-SGPW426621R	1,093
42	72	T-SGPW427221L	T-SGPW427221R	1,133
42	78	T-SGPW427821L	T-SGPW427821R	1,176
42	84	T-SGPW428421L	T-SGPW428421R	1,215
42	90	T-SGPW429021L	T-SGPW429021R	1,258

21" BEAM MOUNT SINGLE SPINE FOR WING, HORIZONTAL GRAIN PATTERN				
H	W	Left	Right	List
		Model Number	Model Number	
46	48	T-SGPW464821L	T-SGPW464821R	947
46	54	T-SGPW465421L	T-SGPW465421R	1,005
46	60	T-SGPW466021L	T-SGPW466021R	1,110
46	66	T-SGPW466621L	T-SGPW466621R	1,194
46	72	T-SGPW467221L	T-SGPW467221R	1,228
46	78	T-SGPW467821L	T-SGPW467821R	1,264
46	84	T-SGPW468421L	T-SGPW468421R	1,299
46	90	T-SGPW469021L	T-SGPW469021R	1,334
50	48	T-SGPW504821L	T-SGPW504821R	1,021
50	54	T-SGPW505421L	T-SGPW505421R	1,097
50	60	T-SGPW506021L	T-SGPW506021R	1,197
50	66	T-SGPW506621L	T-SGPW506621R	1,294
50	72	T-SGPW507221L	T-SGPW507221R	1,323
50	78	T-SGPW507821L	T-SGPW507821R	1,354
50	84	T-SGPW508421L	T-SGPW508421R	1,382
50	90	T-SGPW509021L	T-SGPW509021R	1,411

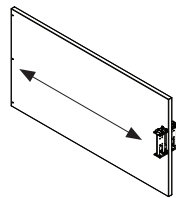

Left Hand Shown

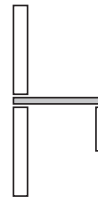

Specify

- Laminate with matching edge

Notes

- Cannot be used freestanding, must be attached to a Beam.
- PowerBeam gallery panels are ordered specific to Beam height.
- Gallery panels add 1 1/8" between or at the end of Beam sections.
- Any gallery panel that extends more than 60" from the Beam must be tied to storage or similar support.

Laminate Gallery Panels – Beam Mount Single Spine for Wing

25" BEAM MOUNT SINGLE SPINE FOR WING, HORIZONTAL GRAIN PATTERN				
H	W	Left	Right	List
		Model Number	Model Number	
29	48	T-SGPW294825L	T-SGPW294825R	720
29	54	T-SGPW295425L	T-SGPW295425R	728
29	60	T-SGPW296025L	T-SGPW296025R	850
29	66	T-SGPW296625L	T-SGPW296625R	890
29	72	T-SGPW297225L	T-SGPW297225R	943
29	78	T-SGPW297825L	T-SGPW297825R	997
29	84	T-SGPW298425L	T-SGPW298425R	1,049
29	90	T-SGPW299025L	T-SGPW299025R	1,103
42	48	T-SGPW424825L	T-SGPW424825R	871
42	54	T-SGPW425425L	T-SGPW425425R	913
42	60	T-SGPW426025L	T-SGPW426025R	1,022
42	66	T-SGPW426625L	T-SGPW426625R	1,093
42	72	T-SGPW427225L	T-SGPW427225R	1,133
42	78	T-SGPW427825L	T-SGPW427825R	1,176
42	84	T-SGPW428425L	T-SGPW428425R	1,215
42	90	T-SGPW429025L	T-SGPW429025R	1,258
46	48	T-SGPW464825L	T-SGPW464825R	947
46	54	T-SGPW465425L	T-SGPW465425R	1,005
46	60	T-SGPW466025L	T-SGPW466025R	1,110
46	66	T-SGPW466625L	T-SGPW466625R	1,194
46	72	T-SGPW467225L	T-SGPW467225R	1,228
46	78	T-SGPW467825L	T-SGPW467825R	1,264
46	84	T-SGPW468425L	T-SGPW468425R	1,299
46	90	T-SGPW469025L	T-SGPW469025R	1,334

25" BEAM MOUNT SINGLE SPINE FOR WING, HORIZONTAL GRAIN PATTERN				
H	W	Left	Right	List
		Model Number	Model Number	
50	48	T-SGPW504825L	T-SGPW504825R	1,021
50	54	T-SGPW505425L	T-SGPW505425R	1,097
50	60	T-SGPW506025L	T-SGPW506025R	1,197
50	66	T-SGPW506625L	T-SGPW506625R	1,294
50	72	T-SGPW507225L	T-SGPW507225R	1,323
50	78	T-SGPW507825L	T-SGPW507825R	1,354
50	84	T-SGPW508425L	T-SGPW508425R	1,382
50	90	T-SGPW509025L	T-SGPW509025R	1,411
58	48	T-SGPW584825L	T-SGPW584825R	1,072
58	54	T-SGPW585425L	T-SGPW585425R	1,126
58	60	T-SGPW586025L	T-SGPW586025R	1,221
58	66	T-SGPW586625L	T-SGPW586625R	1,316
58	72	T-SGPW587225L	T-SGPW587225R	1,410
58	78	T-SGPW587825L	T-SGPW587825R	1,504
58	84	T-SGPW588425L	T-SGPW588425R	1,599
58	90	T-SGPW589025L	T-SGPW589025R	1,694

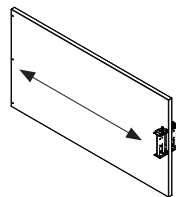

Left Hand Shown



Specify

- Laminate with matching edge

Notes

- Cannot be used freestanding, must be attached to a Beam.
- PowerBeam gallery panels are ordered specific to Beam height.
- Gallery panels add 1 1/8" between or at the end of Beam sections.
- Any gallery panel that extends more than 60" from the Beam must be tied to storage or similar support.

Laminate Gallery Panels – Beam Mount Single Spine for Wing

29" BEAM MOUNT SINGLE SPINE FOR WING, HORIZONTAL GRAIN PATTERN				
H	W	Left	Right	List
		Model Number	Model Number	
29	48	T-SGPW294829L	T-SGPW294829R	720
29	54	T-SGPW295429L	T-SGPW295429R	728
29	60	T-SGPW296029L	T-SGPW296029R	850
29	66	T-SGPW296629L	T-SGPW296629R	890
29	72	T-SGPW297229L	T-SGPW297229R	943
29	78	T-SGPW297829L	T-SGPW297829R	997
29	84	T-SGPW298429L	T-SGPW298429R	1,049
29	90	T-SGPW299029L	T-SGPW299029R	1,103
42	48	T-SGPW424829L	T-SGPW424829R	871
42	54	T-SGPW425429L	T-SGPW425429R	913
42	60	T-SGPW426029L	T-SGPW426029R	1,022
42	66	T-SGPW426629L	T-SGPW426629R	1,093
42	72	T-SGPW427229L	T-SGPW427229R	1,133
42	78	T-SGPW427829L	T-SGPW427829R	1,176
42	84	T-SGPW428429L	T-SGPW428429R	1,215
42	90	T-SGPW429029L	T-SGPW429029R	1,258
46	48	T-SGPW464829L	T-SGPW464829R	947
46	54	T-SGPW465429L	T-SGPW465429R	1,005
46	60	T-SGPW466029L	T-SGPW466029R	1,110
46	66	T-SGPW466629L	T-SGPW466629R	1,194
46	72	T-SGPW467229L	T-SGPW467229R	1,228
46	78	T-SGPW467829L	T-SGPW467829R	1,264
46	84	T-SGPW468429L	T-SGPW468429R	1,299
46	90	T-SGPW469029L	T-SGPW469029R	1,334

29" BEAM MOUNT SINGLE SPINE FOR WING, HORIZONTAL GRAIN PATTERN				
H	W	Left	Right	List
		Model Number	Model Number	
50	48	T-SGPW504829L	T-SGPW504829R	1,021
50	54	T-SGPW505429L	T-SGPW505429R	1,097
50	60	T-SGPW506029L	T-SGPW506029R	1,197
50	66	T-SGPW506629L	T-SGPW506629R	1,294
50	72	T-SGPW507229L	T-SGPW507229R	1,323
50	78	T-SGPW507829L	T-SGPW507829R	1,354
50	84	T-SGPW508429L	T-SGPW508429R	1,382
50	90	T-SGPW509029L	T-SGPW509029R	1,411
58	48	T-SGPW584829L	T-SGPW584829R	1,072
58	54	T-SGPW585429L	T-SGPW585429R	1,126
58	60	T-SGPW586029L	T-SGPW586029R	1,221
58	66	T-SGPW586629L	T-SGPW586629R	1,316
58	72	T-SGPW587229L	T-SGPW587229R	1,410
58	78	T-SGPW587829L	T-SGPW587829R	1,504
58	84	T-SGPW588429L	T-SGPW588429R	1,599
58	90	T-SGPW589029L	T-SGPW589029R	1,694

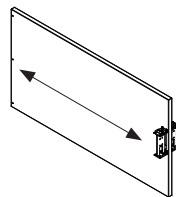

Left Hand Shown

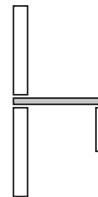

Specify

- Laminate with matching edge

Notes

- Cannot be used freestanding, must be attached to a Beam.
- PowerBeam gallery panels are ordered specific to Beam height.
- Gallery panels add 1 1/8" between or at the end of Beam sections.
- Any gallery panel that extends more than 60" from the Beam must be tied to storage or similar support.

Laminate Gallery Panels – Beam Mount Single Spine for Wing

**21" BEAM MOUNT SINGLE SPINE FOR WING,
VERTICAL GRAIN PATTERN**

H	W	Left	Right	List
		Model Number	Model Number	
29	48	T-SGPW294821LV	T-SGPW294821RV	720
29	54	T-SGPW295421LV	T-SGPW295421RV	728
42	48	T-SGPW424821LV	T-SGPW424821RV	871
42	54	T-SGPW425421LV	T-SGPW425421RV	913
46	48	T-SGPW464821LV	T-SGPW464821RV	947
46	54	T-SGPW465421LV	T-SGPW465421RV	1,005
50	48	T-SGPW504821LV	T-SGPW504821RV	1,021
50	54	T-SGPW505421LV	T-SGPW505421RV	1,097

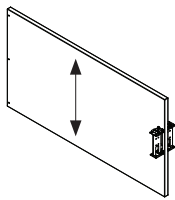

Left Hand Shown

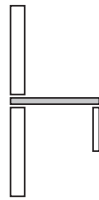

Specify

- Laminate with matching edge

Notes

- Cannot be used freestanding, must be attached to a Beam.
- PowerBeam gallery panels are ordered specific to Beam height.
- Gallery panels add 1 1/8" between or at the end of Beam sections.

Laminate Gallery Panels – Beam Mount Single Spine for Wing

**25" BEAM MOUNT SINGLE SPINE FOR WING,
VERTICAL GRAIN PATTERN**

H	W	Left	Right	List
		Model Number	Model Number	
29	48	T-SGPW294825LV	T-SGPW294825RV	720
29	54	T-SGPW295425LV	T-SGPW295425RV	728
42	48	T-SGPW424825LV	T-SGPW424825RV	871
42	54	T-SGPW425425LV	T-SGPW425425RV	913
46	48	T-SGPW464825LV	T-SGPW464825RV	947
46	54	T-SGPW465425LV	T-SGPW465425RV	1,005
50	48	T-SGPW504825LV	T-SGPW504825RV	1,021
50	54	T-SGPW505425LV	T-SGPW505425RV	1,097
58	48	T-SGPW584825LV	T-SGPW584825RV	1,072
58	54	T-SGPW585425LV	T-SGPW585425RV	1,126

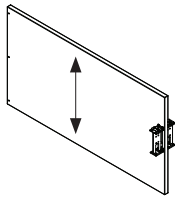

Left Hand Shown

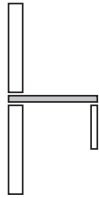

Specify

- Laminate with matching edge

Notes

- Cannot be used freestanding, must be attached to a Beam.
- PowerBeam gallery panels are ordered specific to Beam height.
- Gallery panels add 1 1/8" between or at the end of Beam sections.

Laminate Gallery Panels – Beam Mount Single Spine for Wing

**29" BEAM MOUNT SINGLE SPINE FOR WING,
VERTICAL GRAIN PATTERN**

H	W	Left	Right	List
		Model Number	Model Number	
29	48	T-SGPW294829LV	T-SGPW294829RV	720
29	54	T-SGPW295429LV	T-SGPW295429RV	728
42	48	T-SGPW424829LV	T-SGPW424829RV	871
42	54	T-SGPW425429LV	T-SGPW425429RV	913
46	48	T-SGPW464829LV	T-SGPW464829RV	947
46	54	T-SGPW465429LV	T-SGPW465429RV	1,005
50	48	T-SGPW504829LV	T-SGPW504829RV	1,021
50	54	T-SGPW505429LV	T-SGPW505429RV	1,097
58	48	T-SGPW584829LV	T-SGPW584829RV	1,072
58	54	T-SGPW585429LV	T-SGPW585429RV	1,126

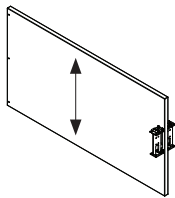

Left Hand Shown

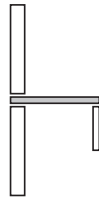

Specify

- Laminate with matching edge

Notes

- Cannot be used freestanding, must be attached to a Beam.
- PowerBeam gallery panels are ordered specific to Beam height.
- Gallery panels add 1 1/8" between or at the end of Beam sections.

Laminate Gallery Panels – Mid Mount Spine

21" MID MOUNT SPINE, HORIZONTAL GRAIN PATTERN

H	W	Left	Right	List
		Model Number	Model Number	
29	24	T-SLMS292421L	T-SLMS292421R	617
29	30	T-SLMS293021L	T-SLMS293021R	645
29	36	T-SLMS293621L	T-SLMS293621R	665
29	42	T-SLMS294221L	T-SLMS294221R	678
29	48	T-SLMS294821L	T-SLMS294821R	687
29	54	T-SLMS295421L	T-SLMS295421R	696
29	60	T-SLMS296021L	T-SLMS296021R	818
29	66	T-SLMS296621L	T-SLMS296621R	858
29	72	T-SLMS297221L	T-SLMS297221R	912
29	78	T-SLMS297821L	T-SLMS297821R	965
29	84	T-SLMS298421L	T-SLMS298421R	1,018
29	90	T-SLMS299021L	T-SLMS299021R	1,071
42	24	T-SLMS422421L	T-SLMS422421R	663
42	30	T-SLMS423021L	T-SLMS423021R	710
42	36	T-SLMS423621L	T-SLMS423621R	753
42	42	T-SLMS424221L	T-SLMS424221R	795
42	48	T-SLMS424821L	T-SLMS424821R	839
42	54	T-SLMS425421L	T-SLMS425421R	880
42	60	T-SLMS426021L	T-SLMS426021R	990
42	66	T-SLMS426621L	T-SLMS426621R	1,060
42	72	T-SLMS427221L	T-SLMS427221R	1,101
42	78	T-SLMS427821L	T-SLMS427821R	1,142
42	84	T-SLMS428421L	T-SLMS428421R	1,184
42	90	T-SLMS429021L	T-SLMS429021R	1,225

21" MID MOUNT SPINE, HORIZONTAL GRAIN PATTERN

H	W	Left	Right	List
		Model Number	Model Number	
46	24	T-SLMS462421L	T-SLMS462421R	684
46	30	T-SLMS463021L	T-SLMS463021R	741
46	36	T-SLMS463621L	T-SLMS463621R	798
46	42	T-SLMS464221L	T-SLMS464221R	855
46	48	T-SLMS464821L	T-SLMS464821R	913
46	54	T-SLMS465421L	T-SLMS465421R	971
46	60	T-SLMS466021L	T-SLMS466021R	1,077
46	66	T-SLMS466621L	T-SLMS466621R	1,161
46	72	T-SLMS467221L	T-SLMS467221R	1,196
46	78	T-SLMS467821L	T-SLMS467821R	1,232
46	84	T-SLMS468421L	T-SLMS468421R	1,266
46	90	T-SLMS469021L	T-SLMS469021R	1,302
50	24	T-SLMS502421L	T-SLMS502421R	705
50	30	T-SLMS503021L	T-SLMS503021R	774
50	36	T-SLMS503621L	T-SLMS503621R	842
50	42	T-SLMS504221L	T-SLMS504221R	914
50	48	T-SLMS504821L	T-SLMS504821R	989
50	54	T-SLMS505421L	T-SLMS505421R	1,064
50	60	T-SLMS506021L	T-SLMS506021R	1,164
50	66	T-SLMS506621L	T-SLMS506621R	1,262
50	72	T-SLMS507221L	T-SLMS507221R	1,292
50	78	T-SLMS507821L	T-SLMS507821R	1,320
50	84	T-SLMS508421L	T-SLMS508421R	1,349
50	90	T-SLMS509021L	T-SLMS509021R	1,377

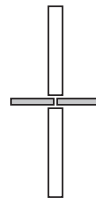
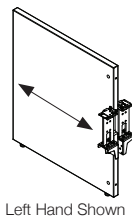

Specify

- Select paint
- Laminate with matching edge

Notes

- Cannot be used freestanding, must be attached to a Beam.
- PowerBeam gallery panels are ordered specific to Beam height.
- Gallery panels add 1 1/8" between or at the end of Beam sections.
- Any gallery panel that extends more than 60" from the Beam must be tied to storage or similar support.

Laminate Gallery Panels – Mid Mount Spine

25" MID MOUNT SPINE, HORIZONTAL GRAIN PATTERN

H	W	Left	Right	List
		Model Number	Model Number	
29	24	T-SLMS292425L	T-SLMS292425R	617
29	30	T-SLMS293025L	T-SLMS293025R	645
29	36	T-SLMS293625L	T-SLMS293625R	665
29	42	T-SLMS294225L	T-SLMS294225R	678
29	48	T-SLMS294825L	T-SLMS294825R	687
29	54	T-SLMS295425L	T-SLMS295425R	696
29	60	T-SLMS296025L	T-SLMS296025R	818
29	66	T-SLMS296625L	T-SLMS296625R	858
29	72	T-SLMS297225L	T-SLMS297225R	912
29	78	T-SLMS297825L	T-SLMS297825R	965
29	84	T-SLMS298425L	T-SLMS298425R	1,018
29	90	T-SLMS299025L	T-SLMS299025R	1,071
42	24	T-SLMS422425L	T-SLMS422425R	663
42	30	T-SLMS423025L	T-SLMS423025R	710
42	36	T-SLMS423625L	T-SLMS423625R	753
42	42	T-SLMS424225L	T-SLMS424225R	795
42	48	T-SLMS424825L	T-SLMS424825R	839
42	54	T-SLMS425425L	T-SLMS425425R	880
42	60	T-SLMS426025L	T-SLMS426025R	990
42	66	T-SLMS426625L	T-SLMS426625R	1,060
42	72	T-SLMS427225L	T-SLMS427225R	1,101
42	78	T-SLMS427825L	T-SLMS427825R	1,142
42	84	T-SLMS428425L	T-SLMS428425R	1,184
42	90	T-SLMS429025L	T-SLMS429025R	1,225

25" MID MOUNT SPINE, HORIZONTAL GRAIN PATTERN

H	W	Left	Right	List
		Model Number	Model Number	
46	24	T-SLMS462425L	T-SLMS462425R	684
46	30	T-SLMS463025L	T-SLMS463025R	741
46	36	T-SLMS463625L	T-SLMS463625R	798
46	42	T-SLMS464225L	T-SLMS464225R	855
46	48	T-SLMS464825L	T-SLMS464825R	913
46	54	T-SLMS465425L	T-SLMS465425R	971
46	60	T-SLMS466025L	T-SLMS466025R	1,077
46	66	T-SLMS466625L	T-SLMS466625R	1,161
46	72	T-SLMS467225L	T-SLMS467225R	1,196
46	78	T-SLMS467825L	T-SLMS467825R	1,232
46	84	T-SLMS468425L	T-SLMS468425R	1,266
46	90	T-SLMS469025L	T-SLMS469025R	1,302
50	24	T-SLMS502425L	T-SLMS502425R	705
50	30	T-SLMS503025L	T-SLMS503025R	774
50	36	T-SLMS503625L	T-SLMS503625R	842
50	42	T-SLMS504225L	T-SLMS504225R	914
50	48	T-SLMS504825L	T-SLMS504825R	989
50	54	T-SLMS505425L	T-SLMS505425R	1,064
50	60	T-SLMS506025L	T-SLMS506025R	1,164
50	66	T-SLMS506625L	T-SLMS506625R	1,262
50	72	T-SLMS507225L	T-SLMS507225R	1,292
50	78	T-SLMS507825L	T-SLMS507825R	1,320
50	84	T-SLMS508425L	T-SLMS508425R	1,349
50	90	T-SLMS509025L	T-SLMS509025R	1,377

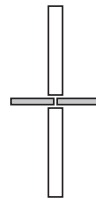
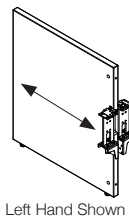

Specify

- Select paint
- Laminate with matching edge

Notes

- Cannot be used freestanding, must be attached to a Beam.
- PowerBeam gallery panels are ordered specific to Beam height.
- Gallery panels add 1 1/8" between or at the end of Beam sections.
- Any gallery panel that extends more than 60" from the Beam must be tied to storage or similar support.

Laminate Gallery Panels – Mid Mount Spine

25" MID MOUNT SPINE, HORIZONTAL GRAIN PATTERN

H	W	Left	Right	List
		Model Number	Model Number	
58	24	T-SLMS582425L	T-SLMS582425R	782
58	30	T-SLMS583025L	T-SLMS583025R	854
58	36	T-SLMS583625L	T-SLMS583625R	917
58	42	T-SLMS584225L	T-SLMS584225R	988
58	48	T-SLMS584825L	T-SLMS584825R	1,041
58	54	T-SLMS585425L	T-SLMS585425R	1,093
58	60	T-SLMS586025L	T-SLMS586025R	1,188
58	66	T-SLMS586625L	T-SLMS586625R	1,282
58	72	T-SLMS587225L	T-SLMS587225R	1,376
58	78	T-SLMS587825L	T-SLMS587825R	1,471
58	84	T-SLMS588425L	T-SLMS588425R	1,566
58	90	T-SLMS589025L	T-SLMS589025R	1,660

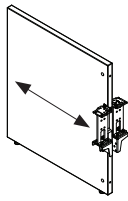

Left Hand Shown

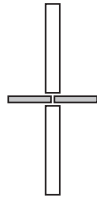

Specify

- Select paint
- Laminate with matching edge

Notes

- Cannot be used freestanding, must be attached to a Beam.
- PowerBeam gallery panels are ordered specific to Beam height.
- Gallery panels add 1 1/8" between or at the end of Beam sections.
- Any gallery panel that extends more than 60" from the Beam must be tied to storage or similar support.

Laminate Gallery Panels – Mid Mount Spine

29" MID MOUNT SPINE, HORIZONTAL GRAIN PATTERN

H	W	Left	Right	List
		Model Number	Model Number	
29	24	T-SLMS292429L	T-SLMS292429R	617
29	30	T-SLMS293029L	T-SLMS293029R	645
29	36	T-SLMS293629L	T-SLMS293629R	665
29	42	T-SLMS294229L	T-SLMS294229R	678
29	48	T-SLMS294829L	T-SLMS294829R	687
29	54	T-SLMS295429L	T-SLMS295429R	696
29	60	T-SLMS296029L	T-SLMS296029R	818
29	66	T-SLMS296629L	T-SLMS296629R	858
29	72	T-SLMS297229L	T-SLMS297229R	912
29	78	T-SLMS297829L	T-SLMS297829R	965
29	84	T-SLMS298429L	T-SLMS298429R	1,018
29	90	T-SLMS299029L	T-SLMS299029R	1,071
42	24	T-SLMS422429L	T-SLMS422429R	663
42	30	T-SLMS423029L	T-SLMS423029R	710
42	36	T-SLMS423629L	T-SLMS423629R	753
42	42	T-SLMS424229L	T-SLMS424229R	795
42	48	T-SLMS424829L	T-SLMS424829R	839
42	54	T-SLMS425429L	T-SLMS425429R	880
42	60	T-SLMS426029L	T-SLMS426029R	990
42	66	T-SLMS426629L	T-SLMS426629R	1,060
42	72	T-SLMS427229L	T-SLMS427229R	1,101
42	78	T-SLMS427829L	T-SLMS427829R	1,142
42	84	T-SLMS428429L	T-SLMS428429R	1,184
42	90	T-SLMS429029L	T-SLMS429029R	1,225

29" MID MOUNT SPINE, HORIZONTAL GRAIN PATTERN

H	W	Left	Right	List
		Model Number	Model Number	
46	24	T-SLMS462429L	T-SLMS462429R	684
46	30	T-SLMS463029L	T-SLMS463029R	741
46	36	T-SLMS463629L	T-SLMS463629R	798
46	42	T-SLMS464229L	T-SLMS464229R	855
46	48	T-SLMS464829L	T-SLMS464829R	913
46	54	T-SLMS465429L	T-SLMS465429R	971
46	60	T-SLMS466029L	T-SLMS466029R	1,077
46	66	T-SLMS466629L	T-SLMS466629R	1,161
46	72	T-SLMS467229L	T-SLMS467229R	1,196
46	78	T-SLMS467829L	T-SLMS467829R	1,232
46	84	T-SLMS468429L	T-SLMS468429R	1,266
46	90	T-SLMS469029L	T-SLMS469029R	1,302
50	24	T-SLMS502429L	T-SLMS502429R	705
50	30	T-SLMS503029L	T-SLMS503029R	774
50	36	T-SLMS503629L	T-SLMS503629R	842
50	42	T-SLMS504229L	T-SLMS504229R	914
50	48	T-SLMS504829L	T-SLMS504829R	989
50	54	T-SLMS505429L	T-SLMS505429R	1,064
50	60	T-SLMS506029L	T-SLMS506029R	1,164
50	66	T-SLMS506629L	T-SLMS506629R	1,262
50	72	T-SLMS507229L	T-SLMS507229R	1,292
50	78	T-SLMS507829L	T-SLMS507829R	1,320
50	84	T-SLMS508429L	T-SLMS508429R	1,349
50	90	T-SLMS509029L	T-SLMS509029R	1,377

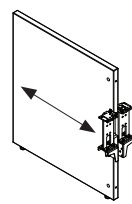

Left Hand Shown

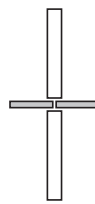

Specify

- Select paint
- Laminate with matching edge

Notes

- Cannot be used freestanding, must be attached to a Beam.
- PowerBeam gallery panels are ordered specific to Beam height.
- Gallery panels add 1 1/8" between or at the end of Beam sections.
- Any gallery panel that extends more than 60" from the Beam must be tied to storage or similar support.

Laminate Gallery Panels – Mid Mount Spine

29" MID MOUNT SPINE, HORIZONTAL GRAIN PATTERN

H	W	Left	Right	List
		Model Number	Model Number	
58	24	T-SLMS582429L	T-SLMS582429R	782
58	30	T-SLMS583029L	T-SLMS583029R	854
58	36	T-SLMS583629L	T-SLMS583629R	917
58	42	T-SLMS584229L	T-SLMS584229R	988
58	48	T-SLMS584829L	T-SLMS584829R	1,041
58	54	T-SLMS585429L	T-SLMS585429R	1,093
58	60	T-SLMS586029L	T-SLMS586029R	1,188
58	66	T-SLMS586629L	T-SLMS586629R	1,282
58	72	T-SLMS587229L	T-SLMS587229R	1,376
58	78	T-SLMS587829L	T-SLMS587829R	1,471
58	84	T-SLMS588429L	T-SLMS588429R	1,566
58	90	T-SLMS589029L	T-SLMS589029R	1,660

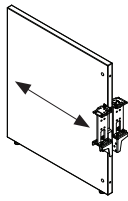

Left Hand Shown

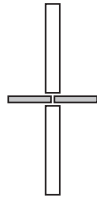

Specify

- Select paint
- Laminate with matching edge

Notes

- Cannot be used freestanding, must be attached to a Beam.
- PowerBeam gallery panels are ordered specific to Beam height.
- Gallery panels add 1 1/8" between or at the end of Beam sections.
- Any gallery panel that extends more than 60" from the Beam must be tied to storage or similar support.

Laminate Gallery Panels – Mid Mount Spine

21" MID MOUNT SPINE, VERTICAL GRAIN PATTERN				
		Left	Right	
H	W	Model Number	Model Number	List
29	24	T-SLMS292421LV	T-SLMS292421RV	617
29	30	T-SLMS293021LV	T-SLMS293021RV	645
29	36	T-SLMS293621LV	T-SLMS293621RV	665
29	42	T-SLMS294221LV	T-SLMS294221RV	678
29	48	T-SLMS294821LV	T-SLMS294821RV	687
29	54	T-SLMS295421LV	T-SLMS295421RV	696
42	24	T-SLMS422421LV	T-SLMS422421RV	663
42	30	T-SLMS423021LV	T-SLMS423021RV	710
42	36	T-SLMS423621LV	T-SLMS423621RV	753
42	42	T-SLMS424221LV	T-SLMS424221RV	795
42	48	T-SLMS424821LV	T-SLMS424821RV	839
42	54	T-SLMS425421LV	T-SLMS425421RV	880

21" MID MOUNT SPINE, VERTICAL GRAIN PATTERN				
		Left	Right	
H	W	Model Number	Model Number	List
46	24	T-SLMS462421LV	T-SLMS462421RV	684
46	30	T-SLMS463021LV	T-SLMS463021RV	741
46	36	T-SLMS463621LV	T-SLMS463621RV	798
46	42	T-SLMS464221LV	T-SLMS464221RV	855
46	48	T-SLMS464821LV	T-SLMS464821RV	913
46	54	T-SLMS465421LV	T-SLMS465421RV	971
50	24	T-SLMS502421LV	T-SLMS502421RV	705
50	30	T-SLMS503021LV	T-SLMS503021RV	774
50	36	T-SLMS503621LV	T-SLMS503621RV	842
50	42	T-SLMS504221LV	T-SLMS504221RV	914
50	48	T-SLMS504821LV	T-SLMS504821RV	989
50	54	T-SLMS505421LV	T-SLMS505421RV	1,064

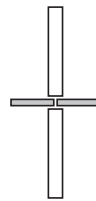
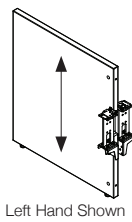

Specify

- Select paint
- Laminate with matching edge

Notes

- Cannot be used freestanding, must be attached to a Beam.
- PowerBeam gallery panels are ordered specific to Beam height.
- Gallery panels add 1 1/8" between or at the end of Beam sections.

Laminate Gallery Panels – Mid Mount Spine

25" MID MOUNT SPINE, VERTICAL GRAIN PATTERN				
		Left	Right	
H	W	Model Number	Model Number	List
29	24	T-SLMS292425LV	T-SLMS292425RV	617
29	30	T-SLMS293025LV	T-SLMS293025RV	645
29	36	T-SLMS293625LV	T-SLMS293625RV	665
29	42	T-SLMS294225LV	T-SLMS294225RV	678
29	48	T-SLMS294825LV	T-SLMS294825RV	687
29	54	T-SLMS295425LV	T-SLMS295425RV	696
42	24	T-SLMS422425LV	T-SLMS422425RV	663
42	30	T-SLMS423025LV	T-SLMS423025RV	710
42	36	T-SLMS423625LV	T-SLMS423625RV	753
42	42	T-SLMS424225LV	T-SLMS424225RV	795
42	48	T-SLMS424825LV	T-SLMS424825RV	839
42	54	T-SLMS425425LV	T-SLMS425425RV	880
46	24	T-SLMS462425LV	T-SLMS462425RV	684
46	30	T-SLMS463025LV	T-SLMS463025RV	741
46	36	T-SLMS463625LV	T-SLMS463625RV	798
46	42	T-SLMS464225LV	T-SLMS464225RV	855
46	48	T-SLMS464825LV	T-SLMS464825RV	913
46	54	T-SLMS465425LV	T-SLMS465425RV	971

25" MID MOUNT SPINE, VERTICAL GRAIN PATTERN				
		Left	Right	
H	W	Model Number	Model Number	List
50	24	T-SLMS502425LV	T-SLMS502425RV	705
50	30	T-SLMS503025LV	T-SLMS503025RV	774
50	36	T-SLMS503625LV	T-SLMS503625RV	842
50	42	T-SLMS504225LV	T-SLMS504225RV	914
50	48	T-SLMS504825LV	T-SLMS504825RV	989
50	54	T-SLMS505425LV	T-SLMS505425RV	1,064
58	24	T-SLMS582425LV	T-SLMS582425RV	782
58	30	T-SLMS583025LV	T-SLMS583025RV	854
58	36	T-SLMS583625LV	T-SLMS583625RV	917
58	42	T-SLMS584225LV	T-SLMS584225RV	988
58	48	T-SLMS584825LV	T-SLMS584825RV	1,041
58	54	T-SLMS585425LV	T-SLMS585425RV	1,093

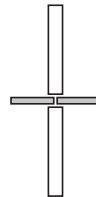
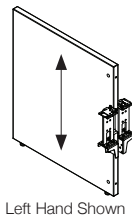

Specify

- Select paint
- Laminate with matching edge

Notes

- Cannot be used freestanding, must be attached to a Beam.
- PowerBeam gallery panels are ordered specific to Beam height.
- Gallery panels add 1 1/8" between or at the end of Beam sections.

Laminate Gallery Panels – Mid Mount Spine

29" MID MOUNT SPINE, VERTICAL GRAIN PATTERN				
		Left	Right	
H	W	Model Number	Model Number	List
29	24	T-SLMS292429LV	T-SLMS292429RV	617
29	30	T-SLMS293029LV	T-SLMS293029RV	645
29	36	T-SLMS293629LV	T-SLMS293629RV	665
29	42	T-SLMS294229LV	T-SLMS294229RV	678
29	48	T-SLMS294829LV	T-SLMS294829RV	687
29	54	T-SLMS295429LV	T-SLMS295429RV	696
42	24	T-SLMS422429LV	T-SLMS422429RV	663
42	30	T-SLMS423029LV	T-SLMS423029RV	710
42	36	T-SLMS423629LV	T-SLMS423629RV	753
42	42	T-SLMS424229LV	T-SLMS424229RV	795
42	48	T-SLMS424829LV	T-SLMS424829RV	839
42	54	T-SLMS425429LV	T-SLMS425429RV	880
46	24	T-SLMS462429LV	T-SLMS462429RV	684
46	30	T-SLMS463029LV	T-SLMS463029RV	741
46	36	T-SLMS463629LV	T-SLMS463629RV	798
46	42	T-SLMS464229LV	T-SLMS464229RV	855
46	48	T-SLMS464829LV	T-SLMS464829RV	913
46	54	T-SLMS465429LV	T-SLMS465429RV	971

29" MID MOUNT SPINE, VERTICAL GRAIN PATTERN				
		Left	Right	
H	W	Model Number	Model Number	List
50	24	T-SLMS502429LV	T-SLMS502429RV	705
50	30	T-SLMS503029LV	T-SLMS503029RV	774
50	36	T-SLMS503629LV	T-SLMS503629RV	842
50	42	T-SLMS504229LV	T-SLMS504229RV	914
50	48	T-SLMS504829LV	T-SLMS504829RV	989
50	54	T-SLMS505429LV	T-SLMS505429RV	1,064
58	24	T-SLMS582429LV	T-SLMS582429RV	782
58	30	T-SLMS583029LV	T-SLMS583029RV	854
58	36	T-SLMS583629LV	T-SLMS583629RV	917
58	42	T-SLMS584229LV	T-SLMS584229RV	988
58	48	T-SLMS584829LV	T-SLMS584829RV	1,041
58	54	T-SLMS585429LV	T-SLMS585429RV	1,093

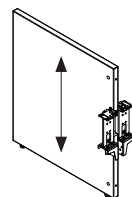

Left Hand Shown

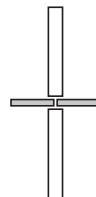

Specify

- Select paint
- Laminate with matching edge

Notes

- Cannot be used freestanding, must be attached to a Beam.
- PowerBeam gallery panels are ordered specific to Beam height.
- Gallery panels add 1 1/8" between or at the end of Beam sections.

Laminate Gallery Panels – Mid Mount Spine for Wing

21" MID MOUNT SPINE FOR WING, HORIZONTAL GRAIN PATTERN

H	W	Left	Right	List
		Model Number	Model Number	
29	48	T-SMWS294821L	T-SMWS294821R	687
29	54	T-SMWS295421L	T-SMWS295421R	696
29	60	T-SMWS296021L	T-SMWS296021R	818
29	66	T-SMWS296621L	T-SMWS296621R	858
29	72	T-SMWS297221L	T-SMWS297221R	912
29	78	T-SMWS297821L	T-SMWS297821R	965
29	84	T-SMWS298421L	T-SMWS298421R	1,018
29	90	T-SMWS299021L	T-SMWS299021R	1,071
42	48	T-SMWS424821L	T-SMWS424821R	839
42	54	T-SMWS425421L	T-SMWS425421R	880
42	60	T-SMWS426021L	T-SMWS426021R	990
42	66	T-SMWS426621L	T-SMWS426621R	1,060
42	72	T-SMWS427221L	T-SMWS427221R	1,101
42	78	T-SMWS427821L	T-SMWS427821R	1,142
42	84	T-SMWS428421L	T-SMWS428421R	1,184
42	90	T-SMWS429021L	T-SMWS429021R	1,225

21" MID MOUNT SPINE FOR WING, HORIZONTAL GRAIN PATTERN

H	W	Left	Right	List
		Model Number	Model Number	
46	48	T-SMWS464821L	T-SMWS464821R	929
46	54	T-SMWS465421L	T-SMWS465421R	989
46	60	T-SMWS466021L	T-SMWS466021R	1,093
46	66	T-SMWS466621L	T-SMWS466621R	1,178
46	72	T-SMWS467221L	T-SMWS467221R	1,212
46	78	T-SMWS467821L	T-SMWS467821R	1,248
46	84	T-SMWS468421L	T-SMWS468421R	1,282
46	90	T-SMWS469021L	T-SMWS469021R	1,318
50	48	T-SMWS504821L	T-SMWS504821R	1,021
50	54	T-SMWS505421L	T-SMWS505421R	1,097
50	60	T-SMWS506021L	T-SMWS506021R	1,197
50	66	T-SMWS506621L	T-SMWS506621R	1,294
50	72	T-SMWS507221L	T-SMWS507221R	1,323
50	78	T-SMWS507821L	T-SMWS507821R	1,354
50	84	T-SMWS508421L	T-SMWS508421R	1,382
50	90	T-SMWS509021L	T-SMWS509021R	1,411

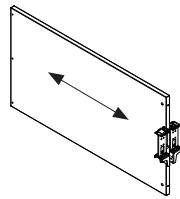

Left Hand Shown

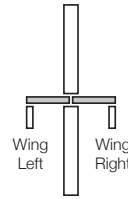

Specify

- Select paint
- Laminate with matching edge

Notes

- Cannot be used freestanding, must be attached to a Beam.
- PowerBeam gallery panels are ordered specific to Beam height.
- Gallery panels add 1 1/8" between or at the end of Beam sections.
- Any gallery panel that extends more than 60" from the Beam must be tied to storage or similar support.

Laminate Gallery Panels – Mid Mount Spine for Wing

25" MID MOUNT SPINE FOR WING, HORIZONTAL GRAIN PATTERN

H	W	Left	Right	List
		Model Number	Model Number	
29	48	T-SMWS294825L	T-SMWS294825R	687
29	54	T-SMWS295425L	T-SMWS295425R	696
29	60	T-SMWS296025L	T-SMWS296025R	818
29	66	T-SMWS296625L	T-SMWS296625R	858
29	72	T-SMWS297225L	T-SMWS297225R	912
29	78	T-SMWS297825L	T-SMWS297825R	965
29	84	T-SMWS298425L	T-SMWS298425R	1,018
29	90	T-SMWS299025L	T-SMWS299025R	1,071
42	48	T-SMWS424825L	T-SMWS424825R	839
42	54	T-SMWS425425L	T-SMWS425425R	880
42	60	T-SMWS426025L	T-SMWS426025R	990
42	66	T-SMWS426625L	T-SMWS426625R	1,060
42	72	T-SMWS427225L	T-SMWS427225R	1,101
42	78	T-SMWS427825L	T-SMWS427825R	1,142
42	84	T-SMWS428425L	T-SMWS428425R	1,184
42	90	T-SMWS429025L	T-SMWS429025R	1,225
46	48	T-SMWS464825L	T-SMWS464825R	929
46	54	T-SMWS465425L	T-SMWS465425R	989
46	60	T-SMWS466025L	T-SMWS466025R	1,093
46	66	T-SMWS466625L	T-SMWS466625R	1,178
46	72	T-SMWS467225L	T-SMWS467225R	1,212
46	78	T-SMWS467825L	T-SMWS467825R	1,248
46	84	T-SMWS468425L	T-SMWS468425R	1,282
46	90	T-SMWS469025L	T-SMWS469025R	1,318

25" MID MOUNT SPINE FOR WING, HORIZONTAL GRAIN PATTERN

H	W	Left	Right	List
		Model Number	Model Number	
50	48	T-SMWS504825L	T-SMWS504825R	1,021
50	54	T-SMWS505425L	T-SMWS505425R	1,097
50	60	T-SMWS506025L	T-SMWS506025R	1,197
50	66	T-SMWS506625L	T-SMWS506625R	1,294
50	72	T-SMWS507225L	T-SMWS507225R	1,323
50	78	T-SMWS507825L	T-SMWS507825R	1,354
50	84	T-SMWS508425L	T-SMWS508425R	1,382
50	90	T-SMWS509025L	T-SMWS509025R	1,411
58	48	T-SMWS584825L	T-SMWS584825R	1,072
58	54	T-SMWS585425L	T-SMWS585425R	1,126
58	60	T-SMWS586025L	T-SMWS586025R	1,221
58	66	T-SMWS586625L	T-SMWS586625R	1,316
58	72	T-SMWS587225L	T-SMWS587225R	1,410
58	78	T-SMWS587825L	T-SMWS587825R	1,504
58	84	T-SMWS588425L	T-SMWS588425R	1,599
58	90	T-SMWS589025L	T-SMWS589025R	1,694

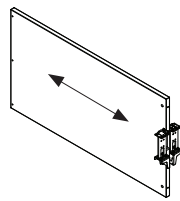

Left Hand Shown

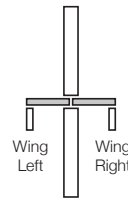

Specify

- Select paint
- Laminate with matching edge

Notes

- Cannot be used freestanding, must be attached to a Beam.
- PowerBeam gallery panels are ordered specific to Beam height.
- Gallery panels add 1 1/8" between or at the end of Beam sections.
- Any gallery panel that extends more than 60" from the Beam must be tied to storage or similar support.

Laminate Gallery Panels – Mid Mount Spine for Wing

29" MID MOUNT SPINE FOR WING, HORIZONTAL GRAIN PATTERN

H	W	Left	Right	List
		Model Number	Model Number	
29	48	T-SMWS294829L	T-SMWS294829R	687
29	54	T-SMWS295429L	T-SMWS295429R	696
29	60	T-SMWS296029L	T-SMWS296029R	818
29	66	T-SMWS296629L	T-SMWS296629R	858
29	72	T-SMWS297229L	T-SMWS297229R	912
29	78	T-SMWS297829L	T-SMWS297829R	965
29	84	T-SMWS298429L	T-SMWS298429R	1,018
29	90	T-SMWS299029L	T-SMWS299029R	1,071
42	48	T-SMWS424829L	T-SMWS424829R	839
42	54	T-SMWS425429L	T-SMWS425429R	880
42	60	T-SMWS426029L	T-SMWS426029R	990
42	66	T-SMWS426629L	T-SMWS426629R	1,060
42	72	T-SMWS427229L	T-SMWS427229R	1,101
42	78	T-SMWS427829L	T-SMWS427829R	1,142
42	84	T-SMWS428429L	T-SMWS428429R	1,184
42	90	T-SMWS429029L	T-SMWS429029R	1,225
46	48	T-SMWS464829L	T-SMWS464829R	929
46	54	T-SMWS465429L	T-SMWS465429R	989
46	60	T-SMWS466029L	T-SMWS466029R	1,093
46	66	T-SMWS466629L	T-SMWS466629R	1,178
46	72	T-SMWS467229L	T-SMWS467229R	1,212
46	78	T-SMWS467829L	T-SMWS467829R	1,248
46	84	T-SMWS468429L	T-SMWS468429R	1,282
46	90	T-SMWS469029L	T-SMWS469029R	1,318

29" MID MOUNT SPINE FOR WING, HORIZONTAL GRAIN PATTERN

H	W	Left	Right	List
		Model Number	Model Number	
50	48	T-SMWS504829L	T-SMWS504829R	1,021
50	54	T-SMWS505429L	T-SMWS505429R	1,097
50	60	T-SMWS506029L	T-SMWS506029R	1,197
50	66	T-SMWS506629L	T-SMWS506629R	1,294
50	72	T-SMWS507229L	T-SMWS507229R	1,323
50	78	T-SMWS507829L	T-SMWS507829R	1,354
50	84	T-SMWS508429L	T-SMWS508429R	1,382
50	90	T-SMWS509029L	T-SMWS509029R	1,411
58	48	T-SMWS584829L	T-SMWS584829R	1,072
58	54	T-SMWS585429L	T-SMWS585429R	1,126
58	60	T-SMWS586029L	T-SMWS586029R	1,221
58	66	T-SMWS586629L	T-SMWS586629R	1,316
58	72	T-SMWS587229L	T-SMWS587229R	1,410
58	78	T-SMWS587829L	T-SMWS587829R	1,504
58	84	T-SMWS588429L	T-SMWS588429R	1,599
58	90	T-SMWS589029L	T-SMWS589029R	1,694

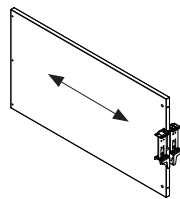

Left Hand Shown

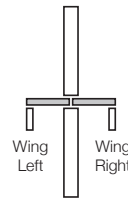

Specify

- Select paint
- Laminate with matching edge

Notes

- Cannot be used freestanding, must be attached to a Beam.
- PowerBeam gallery panels are ordered specific to Beam height.
- Gallery panels add 1 1/8" between or at the end of Beam sections.
- Any gallery panel that extends more than 60" from the Beam must be tied to storage or similar support.

Laminate Gallery Panels – Mid Mount Spine for Wing

21" MID MOUNT SPINE FOR WING, VERTICAL GRAIN PATTERN

H	W	Left	Right	List
		Model Number	Model Number	
29	48	T-SMWS294821LV	T-SMWS294821RV	720
29	54	T-SMWS295421LV	T-SMWS295421RV	728
42	48	T-SMWS424821LV	T-SMWS424821RV	871
42	54	T-SMWS425421LV	T-SMWS425421RV	913
46	48	T-SMWS464821LV	T-SMWS464821RV	947
46	54	T-SMWS465421LV	T-SMWS465421RV	1,005
50	48	T-SMWS504821LV	T-SMWS504821RV	1,021
50	54	T-SMWS505421LV	T-SMWS505421RV	1,097

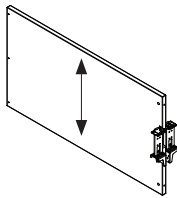

Left Hand Shown

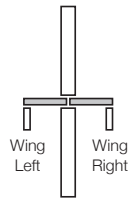

Specify

- Select paint
- Laminate with matching edge

Notes

- Cannot be used freestanding, must be attached to a Beam.
- PowerBeam gallery panels are ordered specific to Beam height.
- Gallery panels add 1 1/8" between or at the end of Beam sections.

Laminate Gallery Panels – Mid Mount Spine for Wing

25" MID MOUNT SPINE FOR WING, VERTICAL GRAIN PATTERN

H	W	Left	Right	List
		Model Number	Model Number	
29	48	T-SMWS294825LV	T-SMWS294825RV	720
29	54	T-SMWS295425LV	T-SMWS295425RV	728
42	48	T-SMWS424825LV	T-SMWS424825RV	871
42	54	T-SMWS425425LV	T-SMWS425425RV	913
46	48	T-SMWS464825LV	T-SMWS464825RV	947
46	54	T-SMWS465425LV	T-SMWS465425RV	1,005
50	48	T-SMWS504825LV	T-SMWS504825RV	1,021
50	54	T-SMWS505425LV	T-SMWS505425RV	1,097
58	48	T-SMWS584825LV	T-SMWS584825RV	1,072
58	54	T-SMWS585425LV	T-SMWS585425RV	1,126

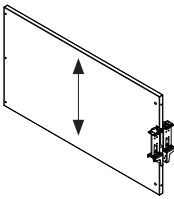

Left Hand Shown

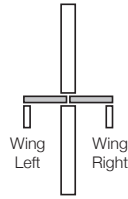

Specify

- Select paint
- Laminate with matching edge

Notes

- Cannot be used freestanding, must be attached to a Beam.
- PowerBeam gallery panels are ordered specific to Beam height.
- Gallery panels add 1 1/8" between or at the end of Beam sections.

Laminate Gallery Panels – Mid Mount Spine for Wing

29" MID MOUNT SPINE FOR WING, VERTICAL GRAIN PATTERN

H	W	Left	Right	List
		Model Number	Model Number	
29	48	T-SMWS294829LV	T-SMWS294829RV	720
29	54	T-SMWS295429LV	T-SMWS295429RV	728
42	48	T-SMWS424829LV	T-SMWS424829RV	871
42	54	T-SMWS425429LV	T-SMWS425429RV	913
46	48	T-SMWS464829LV	T-SMWS464829RV	947
46	54	T-SMWS465429LV	T-SMWS465429RV	1,005
50	48	T-SMWS504829LV	T-SMWS504829RV	1,021
50	54	T-SMWS505429LV	T-SMWS505429RV	1,097
58	48	T-SMWS584829LV	T-SMWS584829RV	1,072
58	54	T-SMWS585429LV	T-SMWS585429RV	1,126

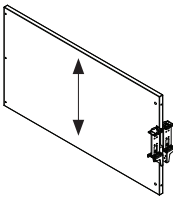

Left Hand Shown

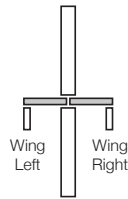

Specify

- Select paint
- Laminate with matching edge

Notes

- Cannot be used freestanding, must be attached to a Beam.
- PowerBeam gallery panels are ordered specific to Beam height.
- Gallery panels add 1 1/8" between or at the end of Beam sections.

Laminate Gallery Wing Panels

WING PANEL, VERTICAL GRAIN PATTERN				
		Left	Right	
H	W	Model Number	Model Number	List
29	24	T-SLWL2924	T-SLWR2924	551
29	30	T-SLWL2930	T-SLWR2930	580
42	24	T-SLWL4224	T-SLWR4224	597
42	30	T-SLWL4230	T-SLWR4230	644
46	24	T-SLWL4624	T-SLWR4624	613
46	30	T-SLWL4630	T-SLWR4630	664
50	24	T-SLWL5024	T-SLWR5024	640
50	30	T-SLWL5030	T-SLWR5030	709
58	24	T-SLWL5824	T-SLWR5824	717
58	30	T-SLWL5830	T-SLWR5830	788

WING PANEL, HORIZONTAL GRAIN PATTERN				
		Left	Right	
H	W	Model Number	Model Number	List
29	24	T-SLWL2924H	T-SLWR2924H	551
29	30	T-SLWL2930H	T-SLWR2930H	580
42	24	T-SLWL4224H	T-SLWR4224H	597
42	30	T-SLWL4230H	T-SLWR4230H	644
46	24	T-SLWL4624H	T-SLWR4624H	613
46	30	T-SLWL4630H	T-SLWR4630H	664
50	24	T-SLWL5024H	T-SLWR5024H	640
50	30	T-SLWL5030H	T-SLWR5030H	709
58	24	T-SLWL5824H	T-SLWR5824H	717
58	30	T-SLWL5830H	T-SLWR5830H	788

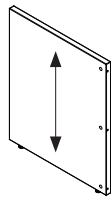

Left Hand Shown

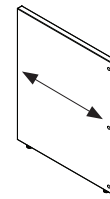

Left Hand Shown

Specify

- Select paint
- Laminate with matching edge

Notes

- Cannot be used freestanding, must be attached to a Beam.
- PowerBeam gallery panels are ordered specific to Beam height.
- Gallery panels add 1 1/8" between or at the end of Beam sections.

Wall Mounted Gallery Panels

WALL MOUNTED GALLERY PANELS – HORIZONTAL

H	W	Model Number	List
29	24	T-WMGP2924	532
29	30	T-WMGP2930	558
29	36	T-WMGP2936	574
29	42	T-WMGP2942	586
29	48	T-WMGP2948	594
29	54	T-WMGP2954	603
29	60	T-WMGP2960	713
29	66	T-WMGP2966	750
29	72	T-WMGP2972	799
29	78	T-WMGP2978	847
29	84	T-WMGP2984	895
29	90	T-WMGP2990	943
29	96	T-WMGP2996	974
41	24	T-WMGP4124	572
41	30	T-WMGP4130	616
41	36	T-WMGP4136	655
41	42	T-WMGP4142	693
41	48	T-WMGP4148	733
41	54	T-WMGP4154	771
41	60	T-WMGP4160	870
41	66	T-WMGP4166	935
41	72	T-WMGP4172	971
41	78	T-WMGP4178	1,009
41	84	T-WMGP4184	1,046
41	90	T-WMGP4190	1,084
41	96	T-WMGP4196	1,168

WALL MOUNTED GALLERY PANELS – HORIZONTAL

H	W	Model Number	List
46	24	T-WMGP4624	591
46	30	T-WMGP4630	645
46	36	T-WMGP4636	696
46	42	T-WMGP4642	747
46	48	T-WMGP4648	801
46	54	T-WMGP4654	855
46	60	T-WMGP4660	950
46	66	T-WMGP4666	1,026
46	72	T-WMGP4672	1,058
46	78	T-WMGP4678	1,090
46	84	T-WMGP4684	1,122
46	90	T-WMGP4690	1,154
46	96	T-WMGP4696	1,238
50	24	T-WMGP5024	611
50	30	T-WMGP5030	674
50	36	T-WMGP5036	736
50	42	T-WMGP5042	801
50	48	T-WMGP5048	869
50	54	T-WMGP5054	938
50	60	T-WMGP5060	1,029
50	66	T-WMGP5066	1,117
50	72	T-WMGP5072	1,144
50	78	T-WMGP5078	1,171
50	84	T-WMGP5084	1,197
50	90	T-WMGP5090	1,223
50	96	T-WMGP5096	1,307

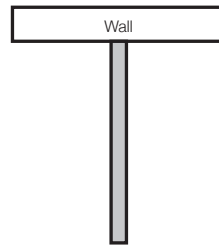
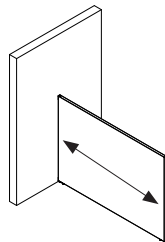

Specify

- Laminate selection
- Paint selection for Mounting Brackets

Notes

- Gallery panels are 1 1/8" with 2mm edge.
- Cannot be used freestanding, must be attached to a wall.
- Wall mounted gallery panels over 66" wide must be attached to storage units for support.
- Laminate gallery panel has matching edge.

Wall Mounted Gallery Panels

WALL MOUNTED GALLERY PANELS – HORIZONTAL

H	W	Model Number	List
58	24	T-WMGP5824	681
58	30	T-WMGP5830	747
58	36	T-WMGP5836	805
58	42	T-WMGP5842	868
58	48	T-WMGP5848	915
58	54	T-WMGP5854	964
58	60	T-WMGP5860	1,050
58	66	T-WMGP5866	1,137
58	72	T-WMGP5872	1,222
58	78	T-WMGP5878	1,307
58	84	T-WMGP5884	1,394
58	90	T-WMGP5890	1,480
58	96	T-WMGP5896	1,555

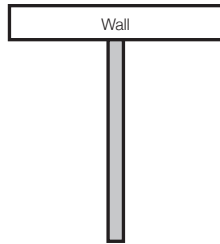
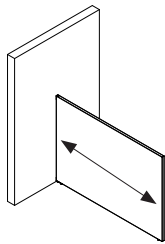

Specify

- Laminate selection
- Paint selection for Mounting Brackets

Notes

- Gallery panels are 1 1/8" with 2mm edge.
- Cannot be used freestanding, must be attached to a wall.
- Wall mounted gallery panels over 66" wide must be attached to storage units for support.
- Laminate gallery panel has matching edge.

Wall Mounted Gallery Panels

WALL MOUNTED GALLERY PANELS – VERTICAL

H	W	Model Number	List
29	24	T-WMGP2924V	532
29	30	T-WMGP2930V	558
29	36	T-WMGP2936V	574
29	42	T-WMGP2942V	586
29	48	T-WMGP2948V	594
29	54	T-WMGP2954V	603
41	24	T-WMGP4124V	572
41	30	T-WMGP4130V	616
41	36	T-WMGP4136V	655
41	42	T-WMGP4142V	693
41	48	T-WMGP4148V	733
41	54	T-WMGP4154V	771
46	24	T-WMGP4624V	591
46	30	T-WMGP4630V	645
46	36	T-WMGP4636V	696
46	42	T-WMGP4642V	747
46	48	T-WMGP4648V	801
46	54	T-WMGP4654V	855

WALL MOUNTED GALLERY PANELS – VERTICAL

H	W	Model Number	List
50	24	T-WMGP5024V	611
50	30	T-WMGP5030V	674
50	36	T-WMGP5036V	736
50	42	T-WMGP5042V	801
50	48	T-WMGP5048V	869
50	54	T-WMGP5054V	938
58	24	T-WMGP5824V	681
58	30	T-WMGP5830V	747
58	36	T-WMGP5836V	805
58	42	T-WMGP5842V	868
58	48	T-WMGP5848V	915
58	54	T-WMGP5854V	964

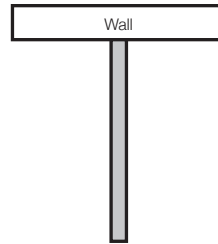
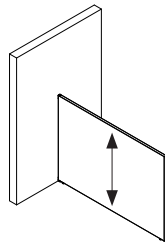

Specify

- Laminate selection
- Paint selection for Mounting Brackets

Notes

- Gallery panels are 1 1/8” with 2mm edge.
- Cannot be used freestanding, must be attached to a wall.
- Wall mounted gallery panels over 66” wide must be attached to storage units for support.
- Laminate gallery panel has matching edge.

Wall Mounted Gallery Panel for Wings

WALL MOUNTED GALLERY PANEL FOR WINGS – HORIZONTAL

H	W	Left	Right	List
		Model Number	Model Number	
29	66	T-WMGPWL2966	T-WMGPWR2966	780
29	72	T-WMGPWL2972	T-WMGPWR2972	829
29	78	T-WMGPWL2978	T-WMGPWR2978	877
29	84	T-WMGPWL2984	T-WMGPWR2984	925
29	90	T-WMGPWL2990	T-WMGPWR2990	974
41	66	T-WMGPWL4166	T-WMGPWR4166	964
41	72	T-WMGPWL4172	T-WMGPWR4172	1,001
41	78	T-WMGPWL4178	T-WMGPWR4178	1,038
41	84	T-WMGPWL4184	T-WMGPWR4184	1,076
41	90	T-WMGPWL4190	T-WMGPWR4190	1,114
46	66	T-WMGPWL4666	T-WMGPWR4666	1,056
46	72	T-WMGPWL4672	T-WMGPWR4672	1,088
46	78	T-WMGPWL4678	T-WMGPWR4678	1,119
46	84	T-WMGPWL4684	T-WMGPWR4684	1,152
46	90	T-WMGPWL4690	T-WMGPWR4690	1,183

WALL MOUNTED GALLERY PANEL FOR WINGS – HORIZONTAL

H	W	Left	Right	List
		Model Number	Model Number	
50	66	T-WMGPWL5066	T-WMGPWR5066	1,147
50	72	T-WMGPWL5072	T-WMGPWR5072	1,174
50	78	T-WMGPWL5078	T-WMGPWR5078	1,200
50	84	T-WMGPWL5084	T-WMGPWR5084	1,226
50	90	T-WMGPWL5090	T-WMGPWR5090	1,252
58	66	T-WMGPWL5866	T-WMGPWR5866	1,166
58	72	T-WMGPWL5872	T-WMGPWR5872	1,251
58	78	T-WMGPWL5878	T-WMGPWR5878	1,338
58	84	T-WMGPWL5884	T-WMGPWR5884	1,424
58	90	T-WMGPWL5890	T-WMGPWR5890	1,509

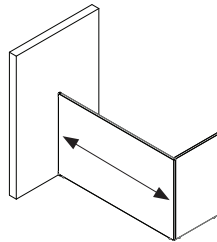

Left Hand Shown

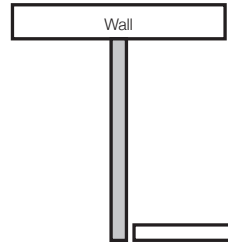

Left Hand Shown

Specify

- Laminate selection
- Paint selection for Mounting Brackets

Notes

- Gallery panels are 1 1/8" with 2mm edge.
- Cannot be used freestanding, must be attached to a wall.
- Laminate gallery panel has matching edge.

Glass 1/4" Universal Spine Insert Screens

GLASS 1/4" UNIVERSAL SPINE INSERT SCREENS						
H	W	Horizon Planning	Model Number	Clear Glass	Bronze/Gray Glass	Frosted Glass
12	36	42"H	O-3-1236	364	+ 50	+ 182
12	42	42"H	O-3-1242	394	+ 58	+ 212
12	48	42"H	O-3-1248	422	+ 66	+ 242
12	54	42"H	O-3-1254	542	+ 75	+ 273
12	60	42"H	O-3-1260	480	+ 83	+ 303
12	66	42"H	O-3-1266	508	+ 91	+ 333
12	72	42"H	O-3-1272	537	+ 99	+ 363
12	78	42"H	O-3-1278	566	+ 108	+ 394
12	84	42"H	O-3-1284	594	+ 116	+ 424
16	36	46"H	O-3-1636	542	+ 65	+ 236
16	42	46"H	O-3-1642	571	+ 76	+ 276
16	48	46"H	O-3-1648	603	+ 86	+ 316
16	54	46"H	O-3-1654	655	+ 97	+ 355
16	60	46"H	O-3-1660	700	+ 108	+ 394
16	66	46"H	O-3-1666	713	+ 119	+ 434
16	72	46"H	O-3-1672	734	+ 129	+ 473
16	78	46"H	O-3-1678	750	+ 140	+ 513
16	84	46"H	O-3-1684	767	+ 151	+ 552

GLASS 1/4" UNIVERSAL SPINE INSERT SCREENS						
H	W	Horizon Planning	Model Number	Clear Glass	Bronze/Gray Glass	Frosted Glass
20	36	50"H	O-3-2036	508	+ 80	+ 291
20	42	50"H	O-3-2042	578	+ 93	+ 340
20	48	50"H	O-3-2048	631	+ 106	+ 389
20	54	50"H	O-3-2054	683	+ 120	+ 437
20	60	50"H	O-3-2060	736	+ 133	+ 486
20	66	50"H	O-3-2066	789	+ 146	+ 535
20	72	50"H	O-3-2072	841	+ 159	+ 583
20	78	50"H	O-3-2078	896	+ 173	+ 632
20	84	50"H	O-3-2084	949	+ 186	+ 680
24	36	54"H	O-3-2436	586	+ 95	+ 346
24	42	54"H	O-3-2442	647	+ 111	+ 404
24	48	54"H	O-3-2448	710	+ 126	+ 462
24	54	54"H	O-3-2454	773	+ 142	+ 520
24	60	54"H	O-3-2460	835	+ 158	+ 577
24	66	54"H	O-3-2466	898	+ 174	+ 635
24	72	54"H	O-3-2472	958	+ 189	+ 693
24	78	54"H	O-3-2478	1,020	+ 205	+ 751
24	84	54"H	O-3-2484	1,082	+ 221	+ 808

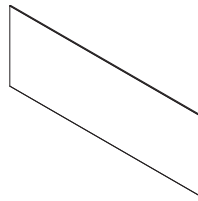

Specify

- Glass Type

Notes

- Universal Spine Insert Screens are designed to up-mount in the spine beam.
- Frosted glass is etched on one side. Patterned glass is patterned vertically as standard. Specials for horizontally patterned glass cannot be manufactured larger than 72" in width.
- Universal Spine Insert Screens can only be used on spine beam sections that are mounted to Calibrate storage elements, supported by end panels or attached to other beams sections at 90 degree or 120 degree angles.
- Glass Universal Spine Insert Screens cannot be used on straight runs with T-feet only.

Class 3/8" Universal Spine Insert Screens

GLASS 3/8" UNIVERSAL SPINE INSERT SCREENS						
H	W	Horizon Planning	Model Number	Clear Glass	Bronze/Gray Glass	Frosted Glass
12	36	42"H	O-SGH1236	599	+ 50	+ 99
12	42	42"H	O-SGH1242	664	+ 58	+ 116
12	48	42"H	O-SGH1248	728	+ 66	+ 132
12	54	42"H	O-SGH1254	794	+ 75	+ 149
12	60	42"H	O-SGH1260	859	+ 83	+ 165
12	66	42"H	O-SGH1266	924	+ 91	+ 182
12	72	42"H	O-SGH1272	989	+ 99	+ 198
12	78	42"H	O-SGH1278	1,055	+ 108	+ 215
12	84	42"H	O-SGH1284	1,119	+ 116	+ 231
16	36	46"H	O-SGH1636	615	+ 65	+ 129
16	42	46"H	O-SGH1642	706	+ 76	+ 151
16	48	46"H	O-SGH1648	801	+ 86	+ 172
16	54	46"H	O-SGH1654	869	+ 97	+ 194
16	60	46"H	O-SGH1660	900	+ 108	+ 215
16	66	46"H	O-SGH1666	998	+ 119	+ 237
16	72	46"H	O-SGH1672	1,071	+ 129	+ 258
16	78	46"H	O-SGH1678	1,093	+ 140	+ 280
16	84	46"H	O-SGH1684	1,158	+ 151	+ 301

GLASS 3/8" UNIVERSAL SPINE INSERT SCREENS						
H	W	Horizon Planning	Model Number	Clear Glass	Bronze/Gray Glass	Frosted Glass
20	36	50"H	O-SGH2036	798	+ 80	+ 159
20	42	50"H	O-SGH2042	899	+ 93	+ 186
20	48	50"H	O-SGH2048	998	+ 106	+ 212
20	54	50"H	O-SGH2054	1,100	+ 120	+ 239
20	60	50"H	O-SGH2060	1,200	+ 133	+ 265
20	66	50"H	O-SGH2066	1,301	+ 146	+ 292
20	72	50"H	O-SGH2072	1,401	+ 159	+ 318
20	78	50"H	O-SGH2078	1,503	+ 173	+ 345
20	84	50"H	O-SGH2084	1,603	+ 186	+ 371
24	36	54"H	O-SGH2436	908	+ 95	+ 189
24	42	54"H	O-SGH2442	1,026	+ 111	+ 221
24	48	54"H	O-SGH2448	1,146	+ 126	+ 252
24	54	54"H	O-SGH2454	1,263	+ 142	+ 284
24	60	54"H	O-SGH2460	1,384	+ 158	+ 315
24	66	54"H	O-SGH2466	1,504	+ 174	+ 347
24	72	54"H	O-SGH2472	1,622	+ 189	+ 378
24	78	54"H	O-SGH2478	1,740	+ 205	+ 410
24	84	54"H	O-SGH2484	1,857	+ 221	+ 441

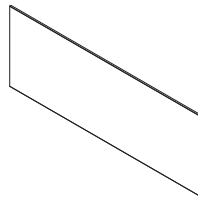

Specify

Notes

- Glass Type

- Universal Spine Insert Screens are designed to up-mount in the spine beam.
- Frosted glass is etched on one side. Patterned glass is patterned vertically as standard. Specials for horizontally patterned glass cannot be manufactured larger than 72" in width.
- Universal Spine Insert Screens can only be used on spine beam sections that are mounted to Calibrate storage elements, supported by end panels or attached to other beams sections at 90 degree or 120 degree angles.
- Glass Universal Spine Insert Screens cannot be used on straight runs with T-feet only.

Lexan 1/4" Universal Spine Insert Screens

LEXAN 1/4" UNIVERSAL SPINE INSERT SCREENS				
H	W	Planning	Model Number	List
12	36	42"H	O-1-1236	494
12	42	42"H	O-1-1242	532
12	48	42"H	O-1-1248	569
12	54	42"H	O-1-1254	605
12	60	42"H	O-1-1260	643
12	66	42"H	O-1-1266	680
12	72	42"H	O-1-1272	717
12	78	42"H	O-1-1278	754
12	84	42"H	O-1-1284	790
16	36	46"H	O-1-1636	569
16	42	46"H	O-1-1642	617
16	48	46"H	O-1-1648	668
16	54	46"H	O-1-1654	717
16	60	46"H	O-1-1660	767
16	66	46"H	O-1-1666	816
16	72	46"H	O-1-1672	867
16	78	46"H	O-1-1678	917
16	84	46"H	O-1-1684	968

LEXAN 1/4" UNIVERSAL SPINE INSERT SCREENS				
H	W	Planning	Model Number	List
20	36	50"H	O-1-2036	643
20	42	50"H	O-1-2042	705
20	48	50"H	O-1-2048	767
20	54	50"H	O-1-2054	830
20	60	50"H	O-1-2060	895
20	66	50"H	O-1-2066	956
20	72	50"H	O-1-2072	1,019
20	78	50"H	O-1-2078	1,082
20	84	50"H	O-1-2084	1,142

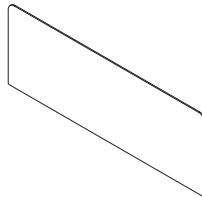

Specify

Notes

- Universal Spine Insert Screens are designed to up-mount in the spine beam.
- Universal Spine Insert Screens can only be used on spine beam sections that are mounted to Calibrate storage elements, supported by end panels or attached to other beams sections at 90 degree or 120 degree angles.
- Lexan Universal Spine Insert Screens cannot be used on straight runs with T-feet only.

PET Universal Spine Insert Screens

PET UNIVERSAL SPINE INSERT SCREENS

H	W	Planning	Model Number	List
12	36	42"H	O-5-1236	326
12	42	42"H	O-5-1242	335
12	48	42"H	O-5-1248	346
12	54	42"H	O-5-1254	355
12	60	42"H	O-5-1260	364
12	66	42"H	O-5-1266	375
12	72	42"H	O-5-1272	384
12	78	42"H	O-5-1278	394
12	84	42"H	O-5-1284	403
16	36	46"H	O-5-1636	346
16	42	46"H	O-5-1642	357
16	48	46"H	O-5-1648	371
16	54	46"H	O-5-1654	384
16	60	46"H	O-5-1660	397
16	66	46"H	O-5-1666	410
16	72	46"H	O-5-1672	422
16	78	46"H	O-5-1678	435
16	84	46"H	O-5-1684	448
20	36	50"H	O-5-2036	364
20	42	50"H	O-5-2042	382
20	48	50"H	O-5-2048	397
20	54	50"H	O-5-2054	413
20	60	50"H	O-5-2060	428
20	66	50"H	O-5-2066	444
20	72	50"H	O-5-2072	462
20	78	50"H	O-5-2078	476
20	84	50"H	O-5-2084	493

PET UNIVERSAL SPINE INSERT SCREENS

H	W	Planning	Model Number	List
24	36	54"H	O-5-2436	384
24	42	54"H	O-5-2442	403
24	48	54"H	O-5-2448	422
24	54	54"H	O-5-2454	441
24	60	54"H	O-5-2460	462
24	66	54"H	O-5-2466	480
24	72	54"H	O-5-2472	498
24	78	54"H	O-5-2478	517
24	84	54"H	O-5-2484	537
28	36	58"H	O-5-2836	403
28	42	58"H	O-5-2842	426
28	48	58"H	O-5-2848	448
28	54	58"H	O-5-2854	470
28	60	58"H	O-5-2860	493
28	66	58"H	O-5-2866	515
28	72	58"H	O-5-2872	537
28	78	58"H	O-5-2878	561
28	84	58"H	O-5-2884	582
32	36	62"H	O-5-3236	422
32	42	62"H	O-5-3242	448
32	48	62"H	O-5-3248	474
32	54	62"H	O-5-3254	498
32	60	62"H	O-5-3260	525
32	66	62"H	O-5-3266	549
32	72	62"H	O-5-3272	575
32	78	62"H	O-5-3278	602
32	84	62"H	O-5-3284	626

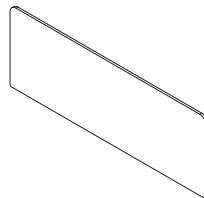

Specify

Notes

• Color Selection for PET - Lite Grey, Medium Grey, Tan or Vibrant Blue

• Universal Spine Insert Screens are designed to up-mount in the spine beam.
 • Universal Spine Insert Screens can only be used on spine beam sections that are mounted to Calibrate storage elements, supported by end panels or attached to other beams sections at 90 degree or 120 degree angles.

Electrical Product Details

8 WIRE 4 CIRCUIT

AIS 8 Wire 4 Circuit electrical system contains four circuits. Each circuit is rated at 20 amps/120 volts maximum. Circuit 1, Circuit 2 and Circuit 3 are served by a system neutral and an equipment ground. Circuit 4 is dedicated and is served by its own neutral and ground. Circuit and ground conductors are #12 A.G.W. (gauge). All neutrals are #10 A.G.W. (gauge).

Shown below is a cross section of metal cable used for 8 Wire 4 Circuit jumpers and infeeds. Circuit and ground conductors are #12 A.G.W. (gauge). All neutrals are #10 A.G.W. (gauge).

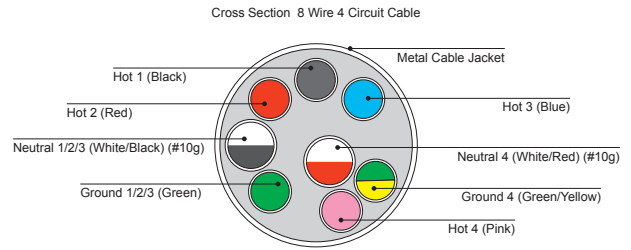
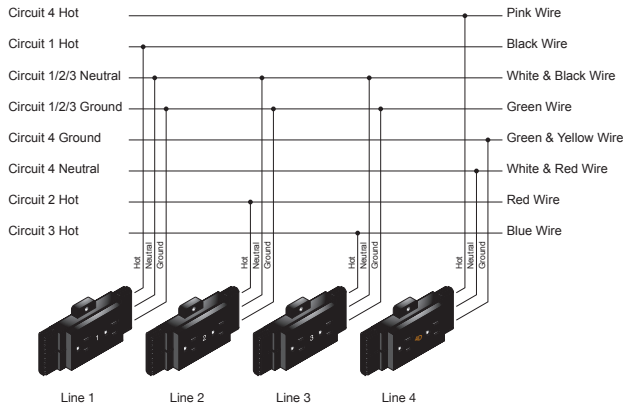

DUPLEX OUTLETS

Duplex Outlets are designated as circuits 1 through 4. Each duplex outlet contains two single receptacles (places to plug into) of the same circuit and are specified separately from powerways. All duplex outlets have black faces. The lettering on outlets for Circuit 1, 2 and 3 is white. The lettering on outlets for Circuit 4 is orange. Outlets are screw mounted to powerway. Duplex outlets are standard 15 amp outlets. For 20 amp outlets, call AIS Customer Service.

BASE FEED WIRING SCHEMATIC - 8 WIRE 4 CIRCUIT SYSTEM

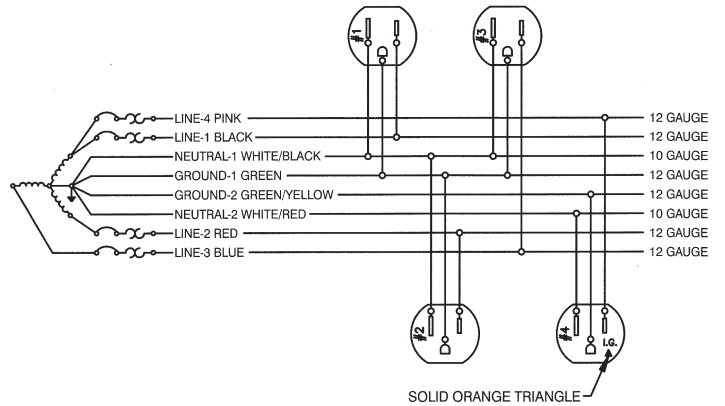

Common Equipment Amperages

Personal Computer	2.00 - 4.00
Laser Printer	5.00 - 8.00
Desktop Plotter	1.50
Fan	1.00
Heater	8.50 - 12.50
Tasklight	1.00
Slide Projector	2.00 - 6.00
Coffee Pot	15.00
Paper Shredder	4.40 - 13.00
Radio	0.05
Pencil Sharpener	1.00
Calculator	0.25
Answering Machine	0.08

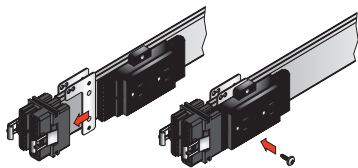

Duplex Outlets

DUPLEX OUTLETS

Line	Color	Model Number	List
1	Black	E-MW8W4DO1	78
2	Black	E-MW8W4DO2	78
3	Black	E-MW8W4DO3	78
4	Black	E-MW8W4DO4	78
1	White	E-MW8W4DO1-W	78
2	White	E-MW8W4DO2-W	78
3	White	E-MW8W4DO3-W	78
4	White	E-MW8W4DO4-W	78

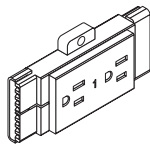

CALIFORNIA TITLE 24 CONTROLLED DUPLEX OUTLETS

Line	Color	Model Number	List
1	Black	E-MW8W4T24DO1	90
2	Black	E-MW8W4T24DO2	90
3	Black	E-MW8W4T24DO3	90
4	Black	E-MW8W4T24DO4	90
1	White	E-MW8W4T24DO1-W	90
2	White	E-MW8W4T24DO2-W	90
3	White	E-MW8W4T24DO3-W	90
4	White	E-MW8W4T24DO4-W	90

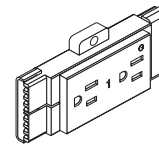

Notes

- Duplex Outlets are available at designated circuits 1 through 4.
- Each duplex outlet contains two single receptacles (places to plug into) of the same circuit and are specified separately from powerways.
- Available in black or white. The lettering on outlets for Circuit 1, 2 and 3 is white. The lettering on outlets for Circuit 4 is orange.
- Outlets are screw mounted to powerway.
- Duplex outlets are standard 15 amp outlets.
- Can be used with multi-circuit electrical units.

Notes

- In California, 50 percent of all outlets in a systems panel cluster or benching cluster, for new construction, MUST be controlled outlets, even if there is no task lighting.
- Customers should plan on using circuits 2 and 3 for controlled circuits, and plan general load for all other items on circuits 1 and 4.
- If using 2 + 2 configuration, controlled circuits should be 1 and 2, and general load circuits on 4 and 5.
- Outlets must have the “controlled” symbol for identification purposes.
- Can be used with multi-circuit electrical units.

Duplex Outlets

USB OUTLETS

Line	Color	Model Number	List
1	Black	E-UN8W4USB01	317
2	Black	E-UN8W4USB02	317
3	Black	E-UN8W4USB03	317
4	Black	E-UN8W4USB04	317
1	White	E-UN8W4USB01-W	283
2	White	E-UN8W4USB02-W	283
3	White	E-UN8W4USB03-W	283
4	White	E-UN8W4USB04-W	283

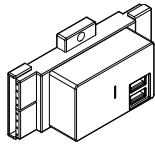

Notes

- USB Outlets bring charging options to panel power distribution systems.
- The USB Outlets provide convenient charging power access through dual ports on the face of the receptacle.
- The USB Outlets offer a total of 2 Amps between two USB charging ports.
- The USB Outlets are UL and FCC Part 15A approved.
- Can be used with multi-circuit electrical units.

DUPLEX OUTLET HOLE COVERS

Model Number	List
E-UNWC	30

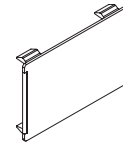

Specify

- Paint Selection for Hole Cover

Notes

- Duplex Outlet Hole Covers are supplied with each powered panel to cover unused duplex outlet locations (six).
- 24"W panels only include three duplex outlet hole covers.
- Order extra hole covers separately only when required.
- Can be used with multi-circuit electrical units.

DATA PLATE KIT

Item	Model Number	List
6 Port Data Gang Plate	E-HDP6B-SM	34
CAT 5e Jack	E-HRJ45-SM	123
CAT 6 Data Jack	E-HXJ6BK-SM	134
Hole Blank (10 Pack)	E-SFBB10-SM	83

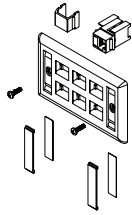

SINGLE GANG PLATE ADAPTER

Model Number	List
E-DJA	47

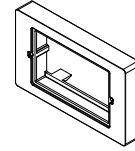

Notes

- Single Gang Plate Adapter required for use with Data Plate Kit and must be ordered separately.
- Available only in black.

Notes

- Single Data Plate Kit has six ports for modular jacks.
- Bezel screws directly to the access box in pre-drilled and tapped hole pattern.
- RJ-45 jacks can be used in place of RJ-11 jacks.
- Single Gang Plate Adapter required for use with Data Plate Kit and must be ordered separately.

Electrical Jumpers

ELECTRICAL JUMPERS

Actual L	Model Number	List
18	E-MX8W4PTPC18	212
21	E-MX8W4PTPC21	222
24	E-UN8W4VT16	260
30	E-UN8W4J30	276
33	E-HM8W4PJ24	277
37	E-MW8W4PJ18	272
39	E-HM8W4PJ30	277
43	E-MW8W4PJ24	303
45	E-MW8W4PJ24E	315
48	E-UN8W4J48	276
49	E-MW8W4PJ30	324
51	E-MW8W4PJ30E	331
55	E-MW8W4PJ36	334
57	E-MW8W4PJ36E	342
61	E-MW8W4PJ42	345
63	E-MW8W4PJ42E	351
67	E-MW8W4PJ48	372
69	E-MW8W4PJ48E	382
79	E-MW8W4PJ60	400
81	E-MW8W4PJ60E	421
86	E-MW8W4PJ86	458

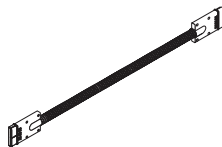

Notes

- Electrical jumpers are used for connecting powered bench top kits to each other in a plan.
- Electrical jumpers are listed in actual lengths to assist with specification.
- Jumper use is explained in the *Jumper Specification Grid* chart.
- **Important:** Certain areas of Chicago prohibit the use of modular electrical systems and require all electrical components to be hard wired. All electrical components need to be supplied by the electrician.

Aloft and PowerBeam Jumper Specification Grid:

Jumper length when joining powered spine beams together.

Bench Width	To 36"	To 42"	To 48"	To 54"	To 60"	To 66"	To 72"	To 78"	To 84"	To 90"	To 96"
From 36"	18	18	21	24	30	30	33	37	39	43	45
From 42"	18	21	24	30	30	33	37	39	43	45	48
From 48"	21	24	30	30	33	37	39	43	45	48	51
From 54"	24	30	30	33	37	39	43	45	48	51	55
From 60"	30	30	33	37	39	43	45	48	51	55	57
From 66"	30	33	37	39	43	45	48	51	55	57	61
From 72"	33	37	39	43	45	48	51	55	57	61	63
From 78"	37	39	43	45	48	51	55	57	61	63	67
From 84"	39	43	45	48	51	55	57	61	63	67	69
from 90"	43	45	48	51	55	57	61	63	67	69	79
From 96"	45	48	51	55	57	61	63	67	69	79	79

Note: When jumping across 3 or 4-way, specify next longest jumper length.

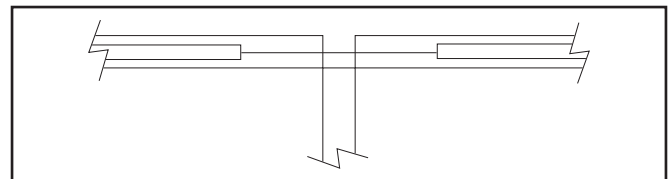

3-Way Condition - use next longest jumper

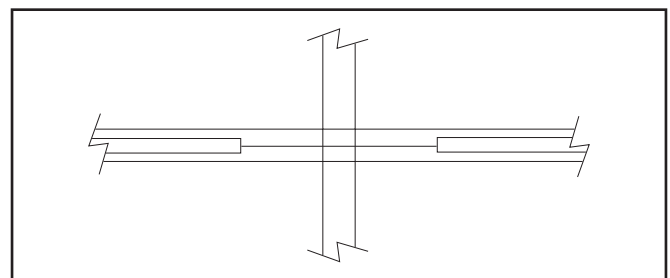

4-Way Condition - use next longest jumper

Example:

60 wide to 60 wide straight connection = 39" jumper.
 60 wide to 60 wide 3 or 4-way specification would require next size up = 43" jumper.

Base In-Feeds, Ceiling In-Feeds, Undermount and End Mount Poles

SIDE-MOUNTED BASE IN-FEEDS

Actual L	Use	Model Number	List
72"	Standard	E-UN8W4BIFS	493
72"	New York City	E-HM8W4BIFSNY	980

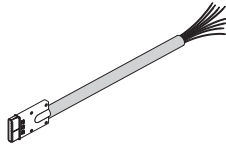

Notes

- Side-mounted base in-feeds provide interface with building power at the end of the power units and mounts to the powerway at jumper location.
- Each base in-feed is 6' in length, encased in "liquid tight".
- New York City code requires the use of a special base feed with an in-line junction box.

CEILING IN-FEED

Actual L	Model Number	List
144"	E-UN8W4CIF	577

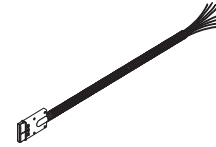

Notes

- Ceiling in-feeds provide interface with building power from a suspended ceiling through a power pole shell.
- Each ceiling feed is 12' long.
- Power pole shells are ordered separately.

UNDERMOUNT POLES

Type	Model Number	List	Grade C Paint
For 21 High	T-BUMP21	424	+25
For 25 High	T-BUMP25	450	+25
For 29 High	T-BUMP29	472	+25



For 21 High



For 25 High



For 29 High

Specify

- Paint Selection

Notes

- Undermount poles can be used to conceal data and electrical cables running from floor to beam trough.
- Poles "telescope" 2 inches to adjust with legs and have a side access mouse hole.
- Poles are mounted at either end of a beam section but cannot be mounted in middle without cutting an access hole in field.
- Order base feed separately.

END MOUNT POLE

Type	Model Number	List	Grade C Paint
For 21 High	T-BEMP21	1,411	+25
For 25 High	T-BEMP25	1,411	+25
For 29 High	T-BEMP29	1,411	+25

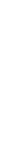

Specify

- Paint Selection

Notes

- End mount poles are used for concealing ceiling in-feeds or data cables from a max 11'6" standard suspended ceiling.
- Choose pole that corresponds to the beam height.
- Order ceiling feed separately.
- Poles must be attached to ceiling grids at time of installation. Beam will not support pole alone.
- Poles are not UL listed for splicing cables in pole and are for aesthetic purposes only.

Pole Extenders, Power Cord Trays and Cable Management Strips

POWER / DATA POLE EXTENDERS

Actual H	Model Number	List	Grade C Paint
28"	A-PPEX28	299	+10
48"	A-PPEX48	432	+10



Specify	Notes
<ul style="list-style-type: none"> • Paint Selection 	<ul style="list-style-type: none"> • Power/data pole extender includes one pole section, one cover, one pole coupler and one divider. • Order ceiling feeds separately.

EXPANDABLE CABLE MANAGEMENT STRIP

Actual L	Model Number	List
72"	O-CMS72	340

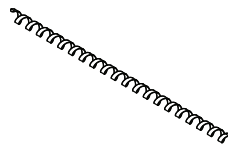

Notes
<ul style="list-style-type: none"> • Expandable cable management strip may be used to dress cable and base in-feed bundle running from wall to trough. • Capable of accommodating 1" to 4" diameter bundles.

POWER CORD TRAYS

W	Model Number	List	Grade C Paint
36	T-BPCT36	143	+10
42	T-BPCT42	160	+10
48	T-BPCT48	179	+10
54	T-BPCT54	195	+10
60	T-BPCT60	213	+10
66	T-BPCT66	233	+10
72	T-BPCT72	249	+10
78	T-BPCT78	255	+10
84	T-BPCT84	273	+10
90	T-BPCT90	289	+10
96	T-BPCT96	303	+10



Specify	Notes
<ul style="list-style-type: none"> • Paint Selection 	<ul style="list-style-type: none"> • Power Cord Trays are ordered separately to mount to the spine beam to accommodate users power cords when plugged into beam. • Trays can span more than one beam section and smaller trays can be mounted on longer beams.

POWERBENCH HAT ENCLOSED BASES

D	W	H	Type	Model Number	List
24	6	21	Single End	T-BBHB24SE	1,452
30	6	21	Single End	T-BBHB30SE	1,591
24	12	21	Single Shared	T-BBHB24SS	1,597
30	12	21	Single Shared	T-BBHB30SS	1,751
36	6	21	Double End	T-BBHB36DE	1,878
48	6	21	Double End	T-BBHB48DE	2,076
60	6	21	Double End	T-BBHB60DE	2,275
36	12	21	Double Shared	T-BBHB36DS	2,065
48	12	21	Double Shared	T-BBHB48DS	2,285
60	12	21	Double Shared	T-BBHB60DS	2,503

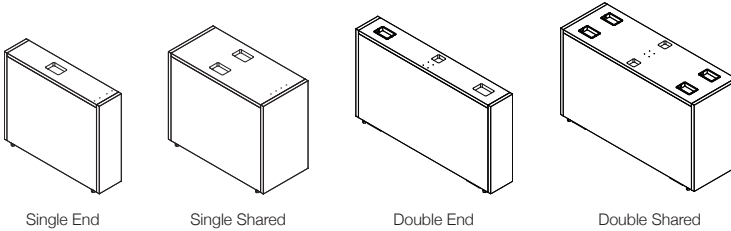

Specify	Notes
<ul style="list-style-type: none"> • Laminate Selection for Base 	<ul style="list-style-type: none"> • Base only, PowerBench HAT worksurface/legs must be ordered separately. • For use with PowerBench HAT's only. • For use with 29" high mounting heights only. • Includes mounting hardware. • Enclosed bases are laminate.

PowerBench HAT Worksurfaces

POWERBENCH HAT STANDARD DEPTH 2-LEG SQUARE EDGE

D	W	H	Worksurface	Model Number	List	Grade C Laminate
23	46	1.14	23 x 46	PB-2HS2448	2,950	+33
23	52	1.14	23 x 52	PB-2HS2454	3,005	+41
23	58	1.14	23 x 58	PB-2HS2460	3,024	+41
23	64	1.14	23 x 64	PB-2HS2466	3,045	+46
23	70	1.14	23 x 70	PB-2HS2472	3,066	+51
23	76	1.14	23 x 76	PB-2HS2478	3,087	+54
23	82	1.14	23 x 82	PB-2HS2484	3,109	+63
29	46	1.14	29 x 46	PB-2HS3048	3,024	+42
29	52	1.14	29 x 52	PB-2HS3054	3,050	+50
29	58	1.14	29 x 58	PB-2HS3060	3,075	+50
29	64	1.14	29 x 64	PB-2HS3066	3,102	+56
29	70	1.14	29 x 70	PB-2HS3072	3,126	+61
29	76	1.14	29 x 76	PB-2HS3078	3,148	+69
29	84	1.14	29 x 84	PB-2HS3084	3,169	+87

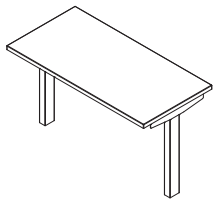

23" Deep

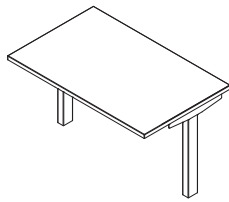

29" Deep

Specify	Notes
<ul style="list-style-type: none"> • Laminate Selection for Worksurface • Color Selection for Edge • Paint Selection for Leg (Black, Metallic Silver or White) • Grommet Locations (+38) • Grommet Cover Color (if applicable) 	<ul style="list-style-type: none"> • Worksurface and legs only, PowerBench base must be ordered separately. • PowerBench HATs are designed to have 1 inch gap behind and 2 inch gap between HATs in a PowerBench run. • Grommet holes with covers are specified as options. • Height adjustment range of 26.26" - 45.94".

Plug-In Power Solutions

ASHLEY UNO

Mounting Type	Model Number	List
Clamp	E-AUTCW	779
Under	E-AUUMW	779

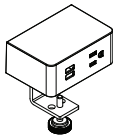

Clamp Mount

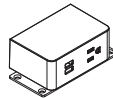

Under Mount

Specify	Notes
• N/A	<ul style="list-style-type: none"> • Features one AC outlet for high-power devices and dual 2.1 amp USB charging ports. • Each USB port utilizes a Smart Device recognition Chip to monitor and deliver the required amperage to your devices. • Available in white. • The unit comes with a 6' cord and is available with surface, under or bezel mounting options. • Fits in standard size grommets. • Bezel mount requires special surface (2.12" x 4.45" hole size, 3/4" - 1 1/2" surface thickness).

ASHLEY DUO

Mounting Type	Model Number	List
Clamp	E-ADTCW	1,211
Under	E-ADUMW	1,211

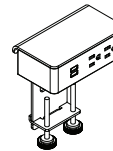

Clamp Mount

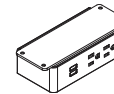

Under Mount

Specify	Notes
• Color (White/White or White/Silver)	<ul style="list-style-type: none"> • Features two AC outlets for high-power devices and dual 2.1 amp USB ports. • Each USB port utilizes a Smart Device Recognition chip to monitor and deliver the required amperage to your devices. • The unit comes with a 72" cord option and is available with surface, under or bezel mounting options. • Fits in standard size grommet. • Bezel mount requires special surface (6" x 2.19" hole size, 1/2" - 1 1/2" surface thickness).

ASHLEY 202

Mounting Type	Model Number	List
Clamp	E-A202TCW	995
Under	E-A202UMW	995

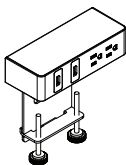

Clamp Mount

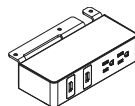

Under Mount

Specify	Notes
• Color (White/White or White/Silver)	<ul style="list-style-type: none"> • Features two AC outlets for high-power devices and two data inserts for your choice of the included blank insert or optional HDMI, RJ-45 or VGA inserts. • The unit comes with a 72" cord and is available with surface, under or bezel mounting options. • Bezel mount requires special surface (2.19" x 7.35" hole size, 3/4" - 1 1/2" surface thickness).

Plug-In Power Solutions

ASHLEY TRIO

Mounting Type	Model Number	List
Clamp	E-ATTCW	1,453
Under	E-ATUMW	1,068

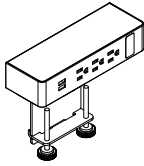

Clamp Mount

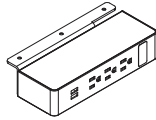

Under Mount

Specify	Notes
<ul style="list-style-type: none"> • Color (White/White or White/Silver) 	<ul style="list-style-type: none"> • Features three AC outlets for high-power devices, two USB ports and a data insert for your choice of the included blank insert or optional HDMI, RJ-45 or VGA inserts. • Each USB port utilizes a Smart Device Recognition Chip to monitor and independently deliver the required amperage for your devices. • The unit comes with a 72" cord option and is available with surface, under or bezel mounting options. • Bezel mount requires special surface (2.19" x 8.50" hole size, 3/4" - 1 1/2" surface thickness).

ASHLEY QUAD

Mounting Type	Model Number	List
Clamp	E-AQTCW	1,781
Under	E-AQUMW	1,781

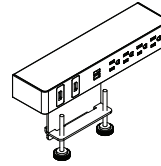

Clamp Mount

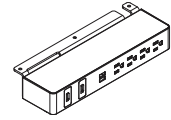

Under Mount

Specify	Notes
<ul style="list-style-type: none"> • Color (Black or White) 	<ul style="list-style-type: none"> • Features four AC outlets for high-power devices, dual 2.1 amp USB charging ports, and options for two data inserts for your choice of the included blank insert or optional HDMI, RJ-45 or VGA inserts. • Each USB port utilizes a Smart Device Recognition Chip to monitor and independently deliver the required amperage to your devices. • The unit comes with a 72" cord and is available with surface, under or bezel mounting options. • Bezel mount requires special surface (2.19" x 11.40" hole size, 3/4" - 1 1/2" surface thickness).

KEYSTONE DATA INSERTS FOR ASHLEY UNITS

Insert Type	Model Number	List
CAT 5e Jack	E-HRJ45-SM	123
CAT 6 Data Jack	E-HXJ6BK-SM	134
HDMI (Female to Female)	E-HDMIFF-SM	292



Specify	Notes

Monitor Arms

SINGLE MONITOR ARM

Model Number	List
A-ERSMASB	805

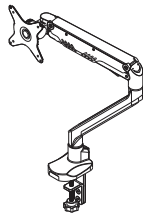

Notes

- Suitable for 10" - 28" size range LCD screens.
- Load capacity of 19lbs per arm.
- Features 180 degree rotation at the mounting base and extension.
- VESA monitor mount for 75mm and 100mm standard.
- Available mounting options include c-clamp, grommet or bolt through.
- Available in silver only.
- Single monitor arm features a snap-in/removable cord clip for wire management.
- Please use the Knife Edge Wedge when attaching monitor arms to knife edge surfaces.

DUAL MONITOR ARM

Model Number	List
A-ERDMASB	1,479

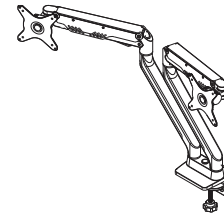

Notes

- Suitable for 10" - 28" size range LCD screens.
- Load capacity of 19lbs per arm.
- Features 180 degree rotation at the mounting base and extension.
- VESA monitor mount for 75mm and 100mm standard.
- Available mounting options include c-clamp, grommet or bolt through.
- Available in silver only.
- Please use the Knife Edge Wedge when attaching monitor arms to knife edge surfaces.

DUAL MONITOR ARM FOR SHALLOW DEPTH WORKSURFACES

Model Number	List
A-ERDMAM9	1,479

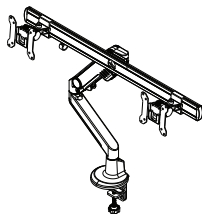

Notes

- Suitable for LCD screens up to 27".
- Load capacity of 14.3 lbs. per monitor.
- Features 180 degree rotation at the mounting base and extension.
- Monitors mount with M4 screws to a VESA bracket.
- VESA monitor mount for 75mm and 100mm standard.
- Mounts with c-clamp on the table edge or through a grommet hole.
- Available in silver only.
- Please use the Knife Edge Wedge when attaching monitor arms to knife edge surfaces.

KNIFE EDGE WEDGE BRACKET

Model Number	List
A-KEW	107

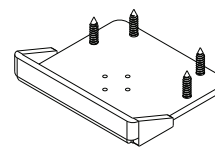

Top View

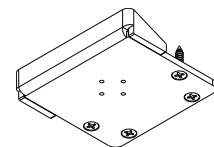

Bottom View

Specify

- Paint Selection

Notes

- Use this product when attaching monitor arms to knife edge surfaces.

Wire Managers and Anti-Fatigue Mats

TABLE WIRE MANAGER

Model Number	List
A-WMJC98	144

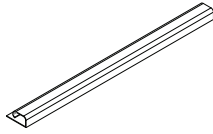

Specify **Notes**

ANTI-FATIGUE MAT

W	D	Thickness	Model Number	List
34	20	3/4	A-HF342075	216

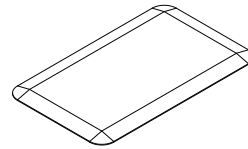

Notes

- Custom blended medium density polyurethane foam.
- High tear strength polyurethane outer membrane.
- Available in black only.

VERTICAL WIRE MANAGERS

Length	Model Number	List
29	A-VWM29	295
50	A-VWM50	598

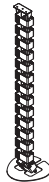

Specify **Notes**

• Flexible chain allows for “lay in” of data and power cords.

• 29” long with weighted base perfect for managing cables from floor to underside of fixed height tables.

• 50” long with weighted base perfect for managing cables from floor to underside of height adjustable tables.

DESKING VERTICAL WIRE MANAGER

L	Model Number	List
40	T-TVWM40	430

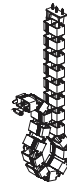

Specify **Notes**

- Flexible chain allows for “lay in” of data and power cords.
- Spans from underside of height adjustable table to beam or power cord tray.

Powerbeam Mini Shelf and Bag Hook

POWERBEAM MINI SHELF

D	W	Model Number	List	Grade C Paint
6	18	T-BMS18	104	+10

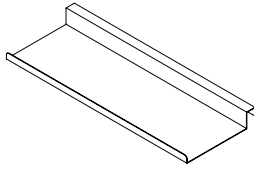

Specify

- Paint Selection

Notes

- Hangs on beam.
- 5 lbs max weight capacity.

POWERBEAM BAG HOOK

Model Number	List	Grade C Paint
T-BBH	63	+10

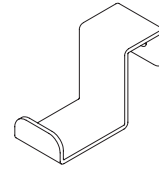

Specify

- Paint Selection

Notes

- Measures 1" x 2".
- Hangs on beam.
- 10 lbs max weight capacity.



National Showrooms:

Leominster

AIS Headquarters
25 Tucker Drive
Leominster, MA 01453

Chicago

The Merchandise Mart
Suite 1086
Chicago, Illinois 60654

New York

AIS New York
257 Park Avenue South
New York, New York 10010

Washington, D.C.

AIS Washington, D.C.
1501 M St, NW, STE 230
Washington, D.C. 20005

GSA Sales

GSA Contract 47QSM20D08Q4
Multiple Award Schedule (MAS)
Large Category: Furniture & Furnishings
Subcategories: Office Furniture, Packaged
Office Furniture and Furniture Services

For additional information on AIS:

Dealer Showrooms, Representative
Directory, Project Case Studies, Online
Catalog & Product Showcase
Visit: www.ais-inc.com