

CALIBRATE COMMUNITY™

March 2023 Price List

AIS

PRODUCT INFORMATION

Calibrate Community Statement of Line 4
 Calibrate Community Finish Options 8
 Calibrate Community Product Details 10
 Calibrate Community Typicals 21

SPINES

Non-Powered Spines 34
 Single Sided Powered Spines 35
 Single Sided Chicago Powered Spines 36
 Double Sided Powered Spines 37
 Double Sided Chicago Powered Spines 38

END PANELS

Top Mount End Panels and Shared Top Mount End Panels 39
 Top Mount Shared End Panels 40
 Mid Mount End Panels 41
 Shared Mid Mount End Panels 42
 Offset Shared End Panels 44
 Shared Mid Mount Offset End Panels 45
 Mid Supports 47
 Infeed Base Supports 48

RUN-OFFS

Fixed Run-Offs 49
 Fixed Round Corner Run-Offs 51
 Sliding Run-Offs 52
 Sliding Round Corner Run-Offs 54
 Sliding Run-Off Tracks 55
 Fixed Spine Surfaces 56
 Cantilevered Spine Surfaces 57
 Stack-On Desks 58

SINGLE SIDED SPINE STACK-ON STORAGE

Spine Hutch F 59
 Spine Hutch G 61
 Spine Hutch J 64
 Spine Cabinet N 65
 Spine Hutches with Sliding Doors 68
 Spine Bookcases 71
 Spine Bookcases with Sliding Doors 72
 Spine Stack-On Two Door Cabinet 75

DOUBLE SIDED SPINE STACK-ON STORAGE

Spine Hutch A 76
 Spine Hutch B 78
 Spine Hutch C 80
 Spine Hutch D 83
 Spine Hutch E 85
 Spine Hutch H 86
 Spine Hutch K 87
 Spine Cabinet L 88
 Spine Cabinet M 89
 Spine Cabinet P 91
 Spine Hutch R 92
 Spine Hutch S 94

STORAGE

13" High Floor Storage 96

21" High BF Pedestals 97

21" High Hidden Drawer BF Pedestals 98

21" High Lateral Floor Storage 99

21" High Floor Bookcases 100

21" High Shared Floor Bookcases 101

21" High Floor Cabinets 102

21" High Floor Credenzas. 103

21" High Combo Units with BF Pedestal and Bookcase 104

ELECTRICAL AND DATA

Electrical Jumpers 105

Outlets 106

Data Plate Kits 108

Infeeds for Infeed Base Supports. 109

ACCESSORIES

Tackboards for Spine Hutch A 110

Tackboards for Spine Hutch B 112

Tackboards for Spine Hutch C 114

Tackboards for Spine Hutch D 116

Tackboards for Spine Hutch E 118

Tackboards for Spine Hutch G 119

Tackboards for Spine Hutch H (Cantilevered). 121

Tackboards for Spine Hutch H (Full Panel) 123

Tackboards for Spine Hutch J 125

Tackboards for Spine Hutch K 127

Tackboards for Spine Hutch N 128

Tackboards for Spine Hutch R 129

Soft Close Mechanism For Hinged Door 131

SPINES

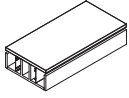

Non-Powered Spine
24 - 36 Wide x 18 - 36 Deep

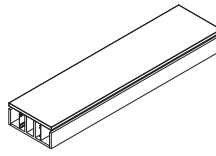

Single Sided Powered Spine
36 - 96 Wide x 18 - 36 Deep

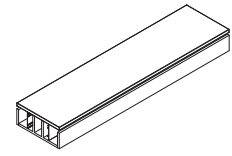

Double Sided Powered Spine
36 - 96 Wide, 18 - 36 Deep

END PANELS

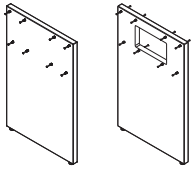

Top Mount End and Shared Panels
18 - 36 Deep, 29 - 46 High
Shared Shown on Right

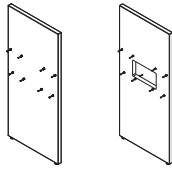

Mid Mount End and Shared Panels
18 - 36 Deep, 29 - 66 High
Shared Shown on Right

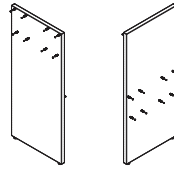

Offset Shared End Panels
18 - 36 Deep, 29 - 46 High
Front Shown on Left, Back Shown on Right

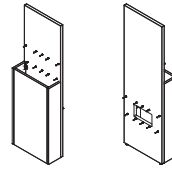

Shared Mid Mount Offset End Panels
18 - 36 Deep, 46 - 66 High
Front Shown on Left, Back Shown on Right

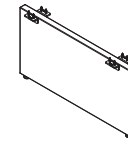

Mid Support
18 - 36 Deep, 13 or 29 High
For use with 21 or 29 High Spines

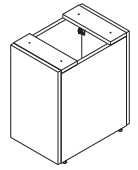

Infeed Base Support
18 - 36 Deep, 6 or 12 Wide, 13 or 21 High
For use with 21 or 29 High Spines

RUN-OFFS

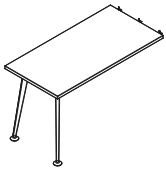

Fixed Run-Off
2mm or Knife Edge
Tapered Legs or O-Leg, On Glides
2mm Edge on Glides Shown

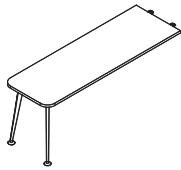

Fixed Round Corner Run-Off
2mm or Knife Edge
Tapered Legs, On Glides
2mm Edge on Glides Shown



Sliding Run-Off
2mm or Knife Edge
Tapered Legs or O-Leg,
On Glides or Casters
2mm Edge on Glides Shown

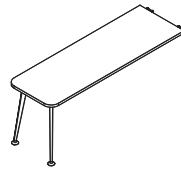

Sliding Round Corner Run-Off
2mm or Knife Edge
Tapered Legs,
On Glides or Casters
2mm Edge on Glides Shown

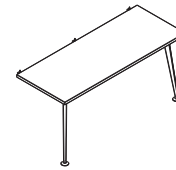

Fixed Spine Surface
2mm or Knife Edge
On Glides
2mm Edge on Glides Shown

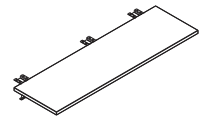

Cantilever Spine Surface
2mm or Knife Edge
2mm Edge Shown

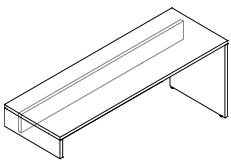

Stack-On Desk
Left, Right or Centered Modesty
Right Modesty Stack-On Desk Shown

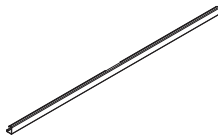

Sliding Run-Off Track

SINGLE SIDED SPINE STACK-ON STORAGE

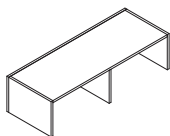

Spine Hutch F
Full Finished Back
12 - 36 High, 24 - 72 Wide, 18 or 24 Deep

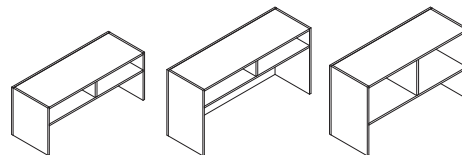

Spine Hutch G
Full Finished Back
20 - 36 High, 24 - 84 Wide, 18 or 24 Deep
20 High with 8 High Cubby Shelf, 28 High with 8 or 16 High Cubby Shelf,
36 High with 16 High Cubby Shelf

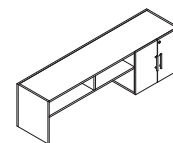

Spine Hutch J
Full Finished Back
20, 28 and 36 High, 60 - 84 Wide, 18 or 24 Deep
8H Cubby Shelf on 20 or 28H, 16H Cubby Shelf on 36H
Left or Right Cabinet Cabinet Right Shown

SINGLE SIDED SPINE STACK-ON STORAGE

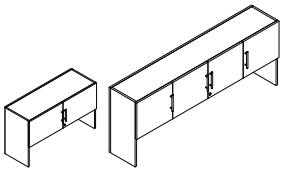

Spine Cabinet N
Full Finished Back
16 - 36 High, 24 - 72 Wide,
14 18 or 24 Deep

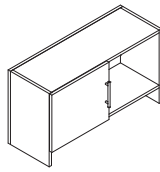

Spine Hutches with Sliding Doors
Full Finished Back
12 - 36 High, 24 - 72 Wide,
14, 18 or 24 Deep
Left or Right-Side Lock
Left-Side Lock Shown

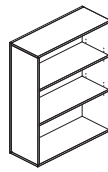

Spine Bookcases
Full Finished Back
36 and 45 High, 18 - 36 Wide,
18 or 24 Deep

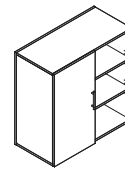

Spine Bookcases with Sliding Doors
Full Finished Back
16 - 36 High, 30 - 60 Wide,
14, 18 or 24 Deep
Left or Right-Side Lock
Left-Side Lock Shown

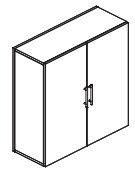

Spine Stack-On Two Door Cabinet
Full Finished Back
37 High, 30 Wide, 18 or 24 Deep

DOUBLE SIDED SPINE STACK-ON STORAGE

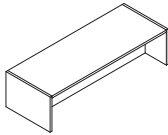

Spine Hutch A
12 - 36 High, 24 - 72 Wide, 18 or 24 Deep

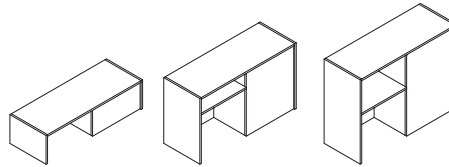

Spine Hutch B
12 - 36 High, 36 - 72 Wide, 18 or 24 Deep, 28 High with 8 High Cubby Shelf, 36 High with 16 High Cubby Shelf, Open Left or Open Right
Open Left Shown

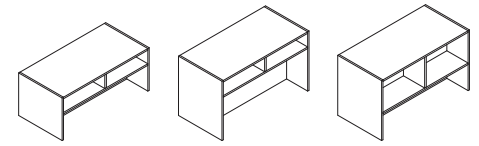

Spine Hutch C
20 - 36 High, 24 - 84 Wide, 24 or 30 Deep
20 High with 8 High Cubby Shelf, 28 High with 8 or 16 High Cubby Shelf, 36 High with 8 or 16 High Cubby Shelf

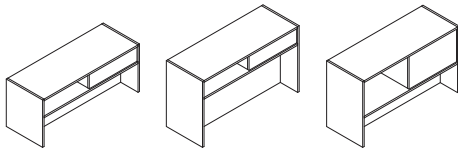

Spine Hutch D
20 - 36 High, 36 - 84 Wide, 18 Deep
20 High with 8 High Cubby Shelf, 28 High with 8 or 16 High Cubby Shelf, 36 High with 8 or 16 High Cubby Shelf
Open Left or Open Right
Open Left Shown

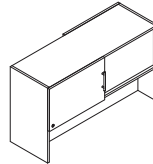

Spine Hutch E
28 and 36 High, 36 - 84 Wide, 18 or 24 Deep
With Sliding Door Cabinet
Door Left or Door Right
Door Left Shown

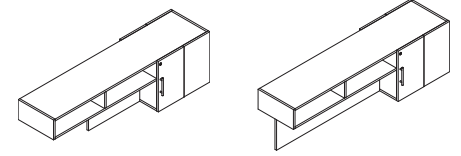

Spine Hutch H
20, 28 or 36 High, 60 - 84 Wide, 18 or 24 Deep
With Yin-Yang Cabinet
Cantilevered or Full Panel
Left: Cantilevered Shown, Right: Full Panel Shown

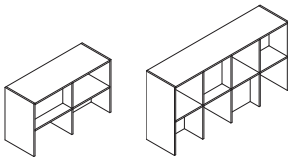

Spine Hutch K
28 or 36 High, 36 - 84 Wide, 18 or 24 Deep
Left: 28H x 48W Shown, Right: 37H x 72W Shown

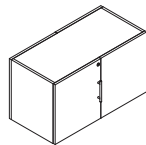

Spine Cabinet L
20, 28 or 36 High, 24 - 48 Wide, 18 or 24 Deep
With Yin-Yang Cabinet
Door Left or Door Right
Door Left Shown

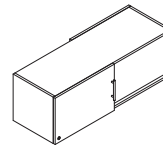

Spine Cabinet M
16 - 36 High, 36 - 84 Wide, 18 or 24 Deep
Door Left or Door Right
Door Left Shown

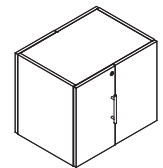

Spine Cabinet O
20 - 36 High, 24 - 48 Wide, 18 or 24 Deep
Door Left or Door Right
Door Left Shown

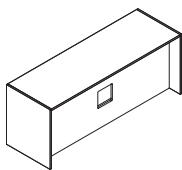

Spine Hutch R
20, 28 or 36 High, 36 - 72 Wide, 18, 24 or 30 Deep

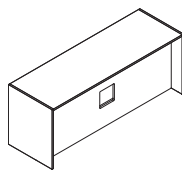

Spine Hutch S
20, 28 or 36 High, 36 - 72 Wide, 18, 24 or 30 Deep

13 HIGH FLOOR STORAGE (FOR 21 HIGH SPINES)

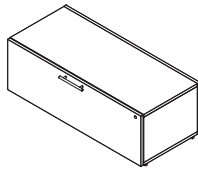

13" High Storage with Single Bottom Box Drawer
15 - 42 Widths, 18 or 24 Depths
18 Depth, 42 Width on Glides Shown
Note: No Filing Capabilities

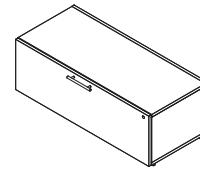

13" High Storage with Bottom and Hidden Top Box Drawer
15 - 42 Widths, 18 or 24 Depths
18 Depth, 42 Width on Glides Shown
Note: No Filing Capabilities

21 HIGH FLOOR STORAGE (FOR 29 HIGH SPINES)

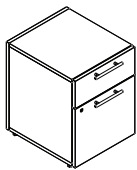

BF Pedestal
12, 16 or 18 Widths, 18, 22 or 24 Depths
On Glides or Feet
18 Depth Pedestal on Glides Shown

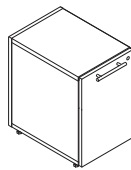

Hidden Drawer BF Pedestal
12, 16 or 18 Widths, 18, 23 or 24 Depths
On Glides or Feet
18 Depth Pedestal on Glides Shown

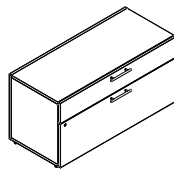

BF Lateral
24 - 42 Widths, 18, 22 or 24 Depths
On Glides or Feet
18 Depth, 42 Width on Glides Shown

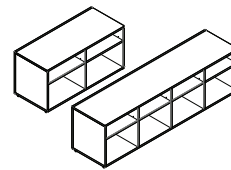

Floor Bookcase
24 - 72 Widths
On Glides or Feet
42 and 72 Widths on Glides Shown

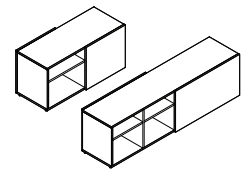

Shared Floor Bookcase
Left or Right Hand, 36 - 72 Widths, 18
Deep, On Glides or Feet
Left Hand 42 and 72 Widths on
Glides Shown

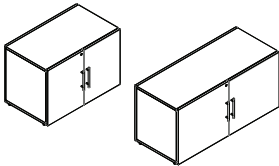

Two Door Cabinet
24 - 48 Widths, 18 Deep
On Glides or Feet
30 and 42 Widths on Glides Shown

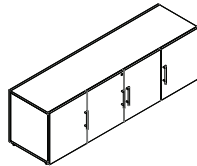

Four Door Cabinet
54 - 72 Widths, 18 Deep
On Glides or Feet
72 Width on Glides Shown

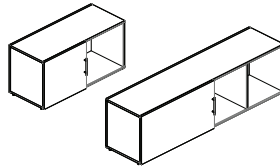

Credenza w/ Sliding Doors
Left or Right Side Lock
36 - 72 Widths, 18 Deep, On Glides or Feet
Left Side Lock in 42 and 72 Widths on
Glides Shown

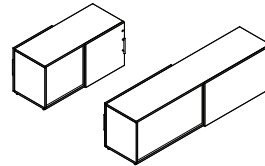

Shared Credenza w/ Sliding Doors
Left or Right Side Lock
36 - 72 Widths, 18 Deep, On Glides or Feet
Right Side Lock in 42 and 72 Widths on
Glides Shown

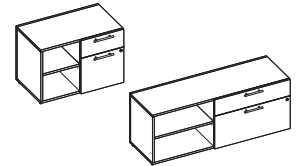

Combo Unit w/
BF Pedestal and Bookcase
30 - 72 Widths, 18 or 24 Depths
On Glides or Feet, Bookcase Left or Right
Bookcase Left 36 and 54 Deep on
Glides Shown

ELECTRICAL AND DATA



Electrical Jumper

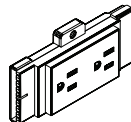

Duplex Outlet

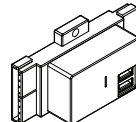

USB Outlet

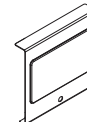

Calibrate Community Outlet Cover

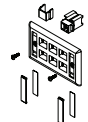

Data Plate Kits

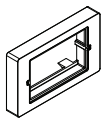

Single Gang Plate Adapter

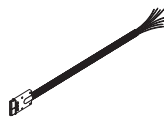

Ceiling Infeed

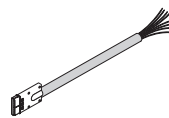

Side-Mounted Base
Infeed



End Mount Poles
For 21 or 29 High

ACCESSORIES

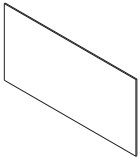

Tackboard for Spine Hutch A
PET or Fabric

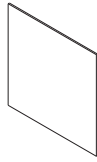

Tackboard for Spine Hutch B
PET or Fabric

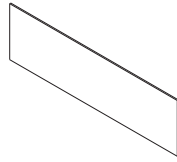

Tackboard for Spine Hutch C
PET or Fabric

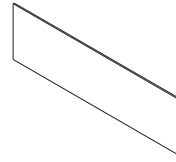

Tackboard for Spine Hutch D
PET or Fabric

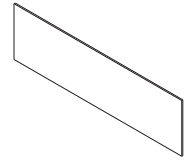

Tackboard for Spine Hutch E
PET or Fabric

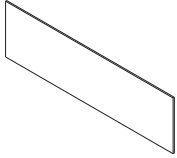

Tackboard for Spine Hutch G
PET or Fabric

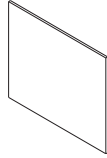

Tackboard for Spine Hutch H
For Cantilevered or Full Panel
PET or Fabric

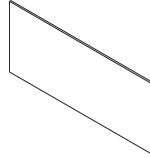

Tackboard for Spine Hutch J
PET or Fabric

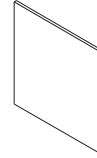

Tackboard for Spine Hutch K
PET or Fabric

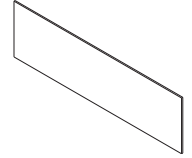

Tackboard for Spine Hutch N
PET or Fabric

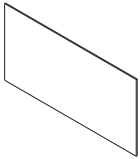

Tackboard for Spine Hutch R
PET or Fabric

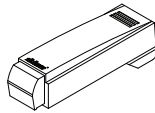

Soft Close Mechanism for
Hinged Door

Tackboard Fabric Options

VERTICAL SURFACE FABRICS

Name	Grade
Amaze	A
Avenue	A
Cape Cod	A
Engage	A
Mirador	A
Rainfall	A
Simplicity	A
Theory	A
Twizzle	A
Lido	B
Marin	B
Nature	B
Off the Grid	B
Purpose	B
Spinel	B
Sprite	B

Note: 66" & 72" wide screens – if applying directional fabrics they will need to be railroaded for application. If using a COM fabric that is 54" wide, any screen over 48" wide would need to have the fabric railroaded as well.

C.O.M. Fabric Policy

- It is mandatory that you work directly with your AIS Customer Service Representative for all COM related testing and orders. They will provide all necessary forms to you, as well as work with you with regard to sending in correct yardage and where to send it, along with necessary RA# or #s. Please note an RA must be submitted along with the fabric for testing, as well as an RA created for an actual order.
- **Please Note:** A three to five yard sample is required for testing and approval for use on all monolithic panel systems. A one yard sample is required for testing and approval on Divi Insert Tiles, Matrix Tiles, flipper doors and tackboards. We may be able to test upholstery fabrics with a swatch, your Customer Service Representative will advise based on the fabric being tested; otherwise a 1 yard sample must be submitted for testing. Results take 48 - 72 hours.
- Customer Service must be advised as to the width of the fabric rolls being supplied (54"W or 60"W). Customer Service must also be advised if the fabric has a backer.
- Yardage required for the job must be calculated by an AIS Customer Service Rep.
- Once AIS has approved the COM fabric, a fabric sample needs to be marked by the dealer with "Front", "Top", and "Bottom", to be sure fabric is applied correctly. The fabric sample then needs to be attached to a COM Fabric Dealer Form and forwarded to AIS Customer Service. [The COM Fabric Dealer Form may be downloaded or printed here.](#)
- Fabrics may be discontinued or obsolete without notice.
- Contact AIS Customer Service with any questions regarding fabric availability.
- All directional fabric will be railroaded.

Laminate and Paint Options

PAINT OPTIONS

Name	Color Code	Grade
Black	BK	A
Chalk	CK	A
Dark Tone	DT	A
Grey Value 1	GV1	A
Innertone	HT	A
Light Tone	LT	A
Medium Tone	MT	A
Metallic Silver	MS	A
Satin White	SW	A
Warm Brown	WB	A
Champagne Metallic	CHM	B
Dark Grey Metallic	DGM	B
Flint Grey Metallic	FGM	B
Light Grey	LG	B
Tan Value 1	TV1	B
Antique Gold	AG	C
Graphite Sky	GS	C
Burnt Orange	BO	C
Brown	BR	C
Steel Blue	SB	C
Baltic Blue	BB	C
Ruby Red	RR	C
Kelly Green	KG	C

Custom Paints

- Extended lead-time will apply.
- Any color not shown on Quick Ship, Standard Grade A or Grade B will be considered custom.
- A \$450 net paint match fee will be assessed following receipt of (2) 5"x5" samples of paint being matched. Additionally, Grade B paint-charges will be applied to all applicable products on the order.
- **Important Note:** Most paint match pricing can be covered by the Grade B up-charge in the catalog, however the final pricing can only be determined after the paint is matched and a product list is provided to AIS customer service. An additional fee may apply based on job size and paint color.

EDGE BAND OPTIONS

Name	Color Code	Grade
Absolute Acajou	AA	A
Aimtoo Savatre	AS	A
Black	BK	A
Brazilwood	BZ	A
Chalk	CK	A
Corporate Walnut	CT	A
Dark Rum Cherry	DR	A
Dark Tone	DT	A
Field Elm	FE	A
Grand Cherry	GC	A
Grey Elm	GE	A
Grey Value 1	GV1	A
Landmark	LM	A
Leave Likatre	LV	A
Light Tone	LT	A
Linen	LN	A
Looks Likatre	LK	A
Maritime Dune	MD	A
Medium Tone	MT	A
Midwest Maple	MM	A
Neo Walnut	NW	A
Phantom Ecrú	PE	A
Phantom Pearl	PP	A
Satin White / True White	SW/TW	A
Storm	ST	A
Summer Drops	SD	A
Trytoo Savatre	TS	A
White Chocolate	WC	A

LAMINATE OPTIONS

Name	Grade
Absolute Acajou	A
Aimtoo Savatre	A
Black	A
Brazilwood	A
Chalk	A
Corporate Walnut	A
Dark Rum Cherry	A
Field Elm	A
Grand Cherry	A
Grey Elm	A
Landmark	A
Leave Likatre	A
Linen	A
Looks Likatre	A
Maritime Dune	A
Midwest Maple	A
Neo Walnut	A
Phantom Ecrú	A
Phantom Pearl	A
Storm	A
Summer Drops	A
True White	A
Trytoo Savatre	A
White Chocolate	A

Laminate options apply to worksurfaces, body/case, desk shell bases, modesties and doors/drawers. Matching edgeband available for all Calibrate laminate options.

Calibrate Community Product Details

Community Spine Dimensions

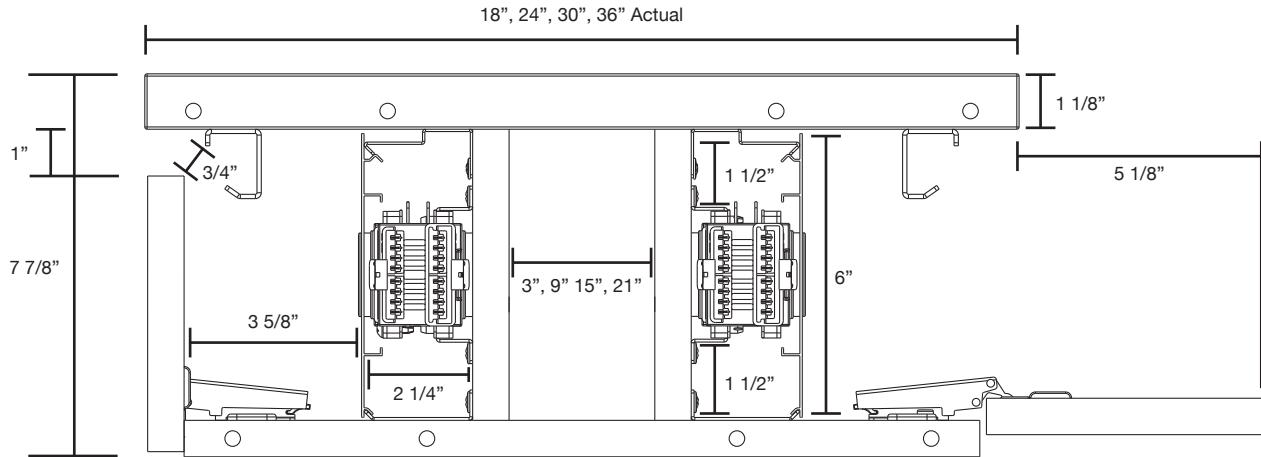

Community Spine Internal Components

1. Duplex Outlet
2. Internal cover (metal)
3. Data cable cavity
4. Electrical cable cavity
5. Front to back power jumper*
6. Powerway
7. Sliding surface track (optional)
8. Egress for power cords
9. Flip down door

*Included on Double Sided Powered Spines.

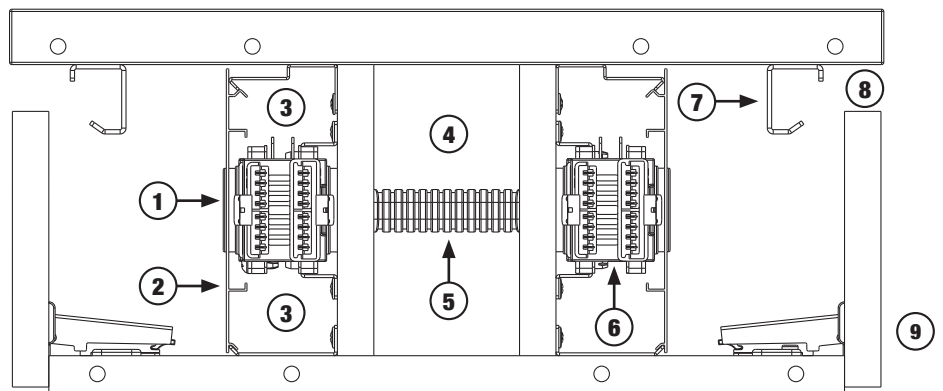

Calibrate Community Product Details

Community Spine External Dimensions and Components

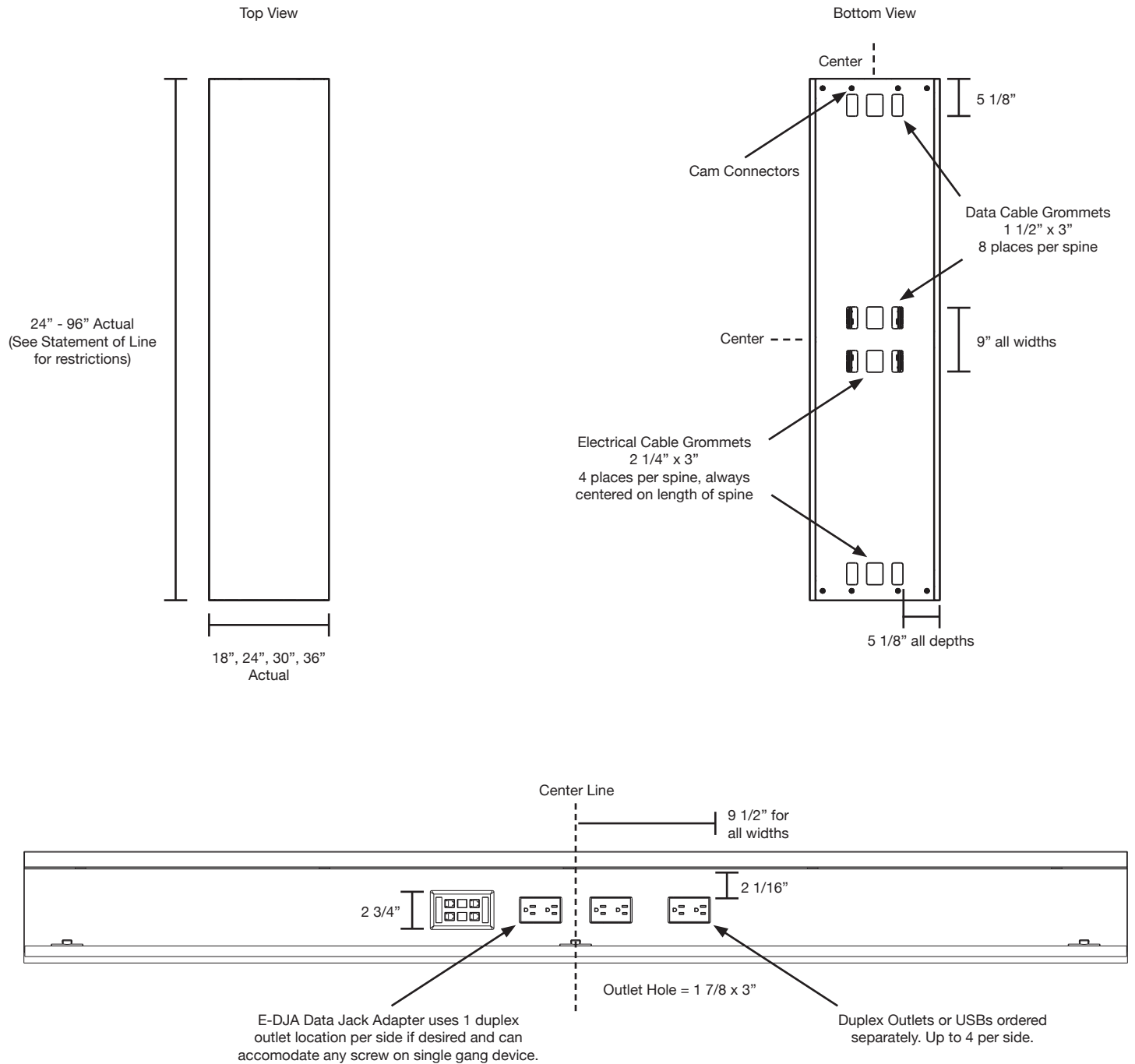

Calibrate Community Product Details

Community Spine Electrical

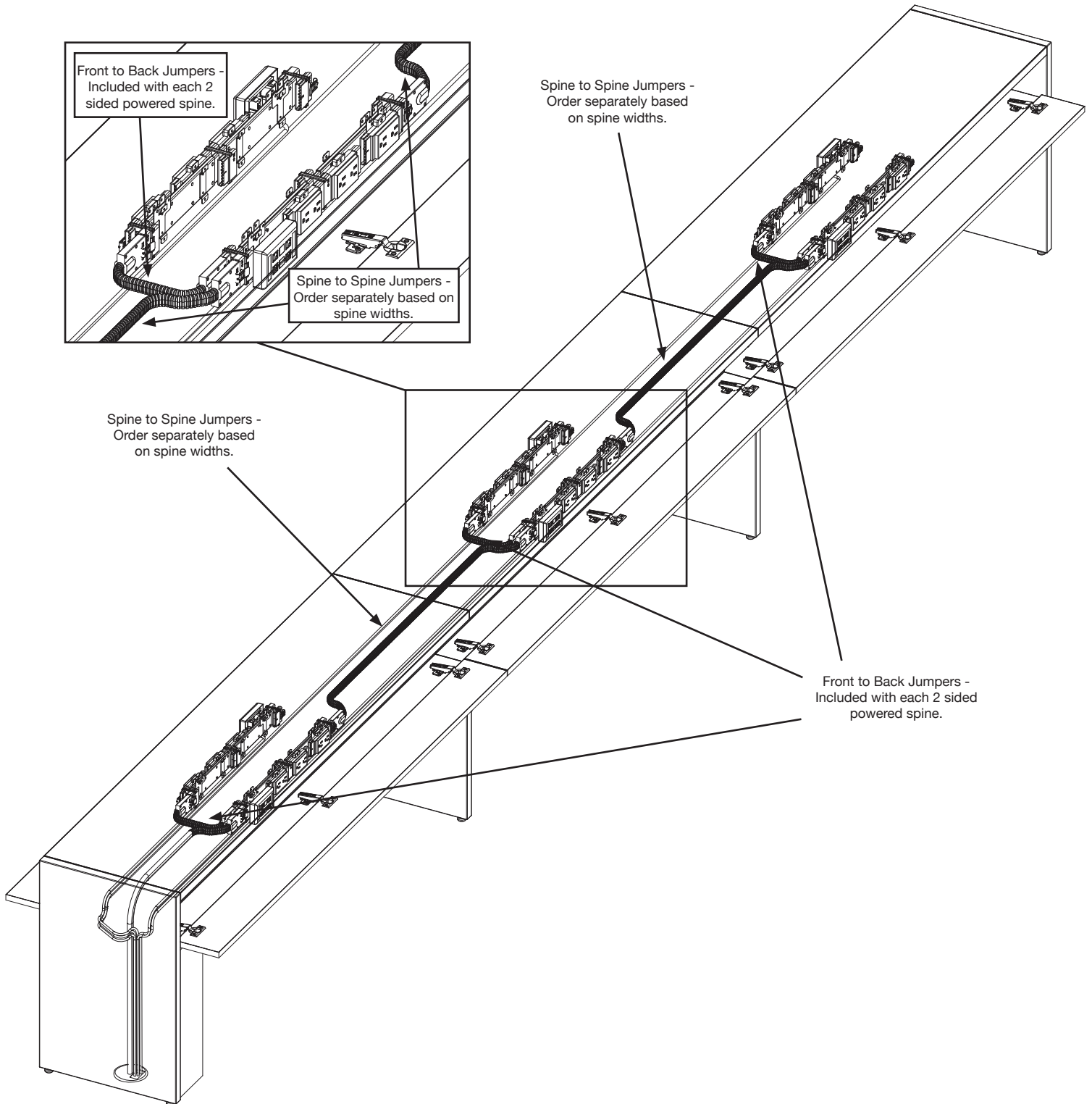

Community Spine Electrical

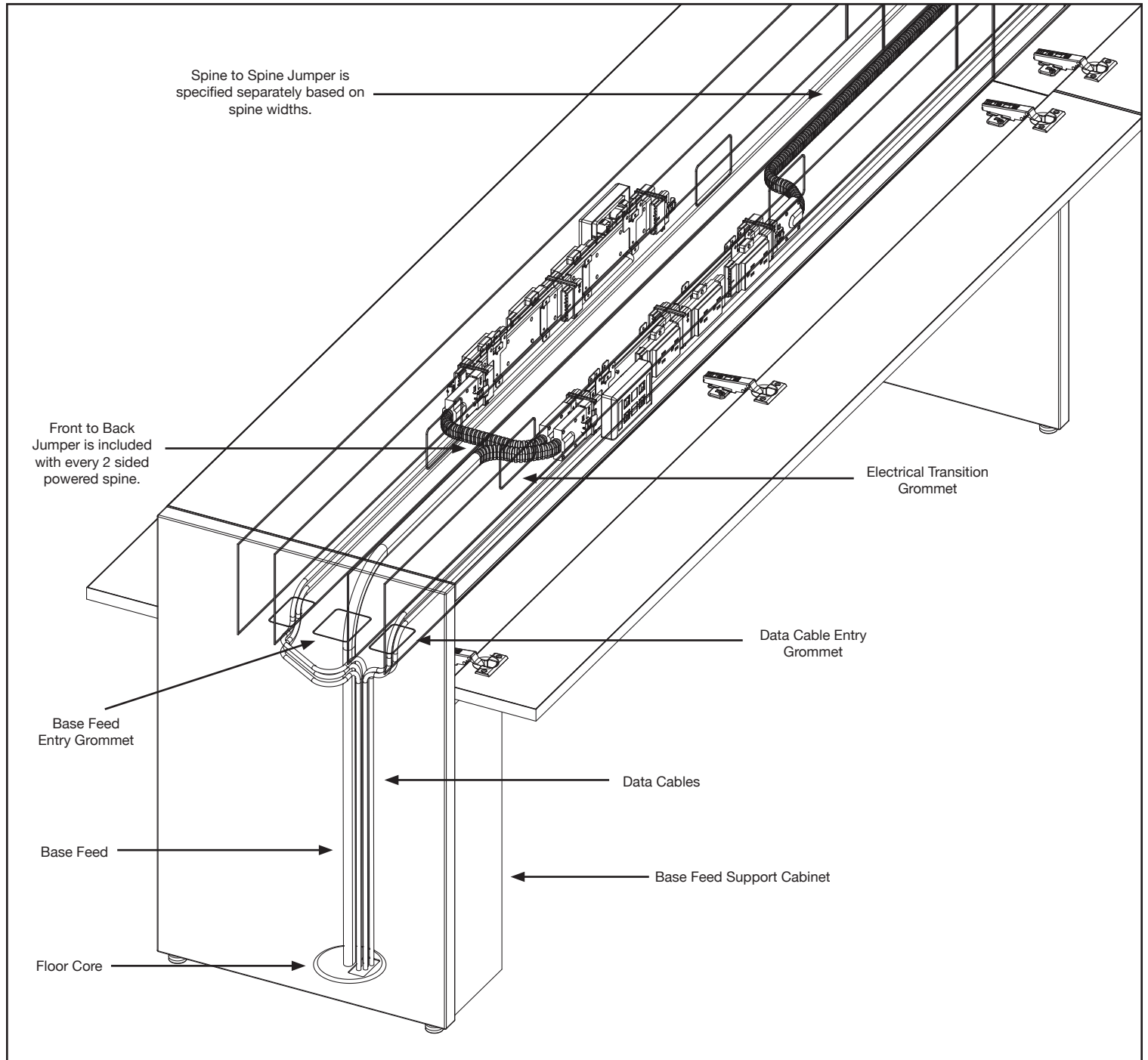

Calibrate Community Product Details

Community Spine Electrical: 8 Wire 4 Circuit

AIS Calibrate Community 8 Wire 4 Circuit electrical system contains four circuits. Each circuit is rated at 20 amps/120 volts maximum. Circuit 1, Circuit 2 and Circuit 3 are served by a system neutral and an equipment ground. Circuit 4 is dedicated and is served by its own neutral and ground. Circuit and ground conductors are #12 A.G.W. (gauge). All neutrals are #10 A.G.W. (gauge).

Shown below is a cross section of metal cable used for 8 Wire 4 Circuit jumpers and infeeds. Circuit and ground conductors are #12 A.G.W. (gauge). All neutrals are #10 A.G.W. (gauge).

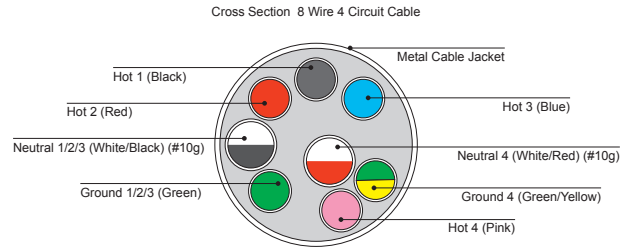
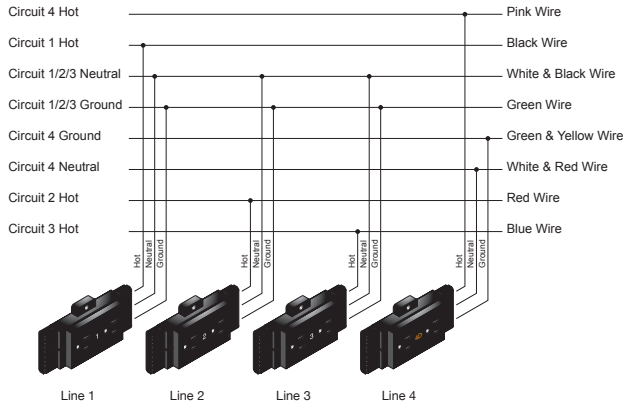

Community Spine Electrical: Duplex Outlets

Duplex Outlets are designated as circuits 1 through 4. Each duplex outlet contains two single receptacles (places to plug into) of the same circuit and are specified separately from powerways. All duplex outlets have black faces. The lettering on outlets for Circuit 1, 2 and 3 is white. The lettering on outlets for Circuit 4 is orange. Outlets are screw mounted to powerway. Duplex outlets are standard 15 amp outlets. For 20 amp outlets, call AIS Customer Service.

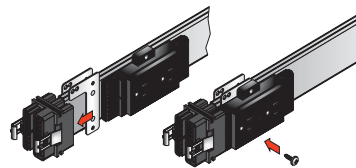

Common Equipment Amperages

Personal Computer	2.00 - 4.00
Laser Printer	5.00 - 8.00
Desktop Plotter	1.50
Fan	1.00
Heater	8.50 - 12.50
Tasklight	1.00
Slide Projector	2.00 - 6.00
Coffee Pot	15.00
Paper Shredder	4.40 - 13.00
Radio	0.05
Pencil Sharpener	1.00
Calculator	0.25
Answering Machine	0.08

Calibrate Community Product Details

Height Adjustable Table Considerations with 29" High Spine

Day to Day HAT (3-Stage) at lowest height (shown below) interferes with open flip door on 29" high elevated spine. Low limit should be set or care should be taken to close door before lowering unit.

E-Series and Calibrate HAT (2-stage) at lowest height (shown below) does not interfere with open flip door on 29" high elevated spine.

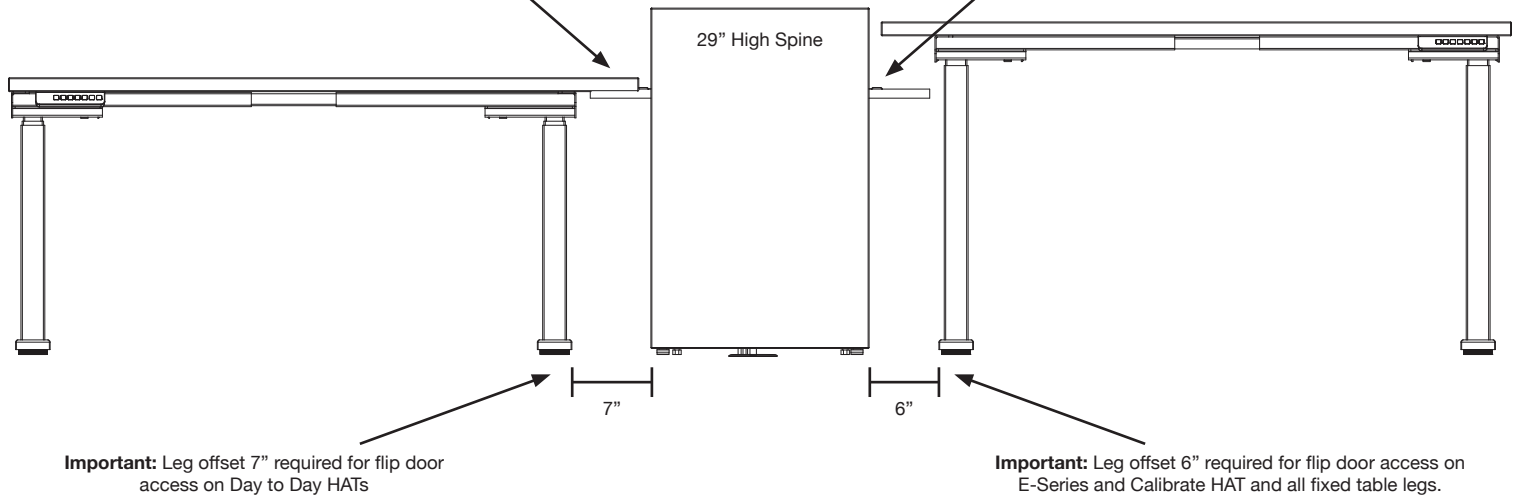

Height Adjustable Table Considerations with 21" High Spine

Day to Day HAT (3-Stage) at lowest height (shown below) can be suspended over 21" high spine with 1" of clearance only.

Leave 1" minimum between adjacent HAT surfaces. Leave 3" for 1" thick screen between surfaces.

E-Series and Calibrate HAT (2-stage) at lowest height (shown below) can be suspended over 21" high spine with 5 1/2" of clearance.

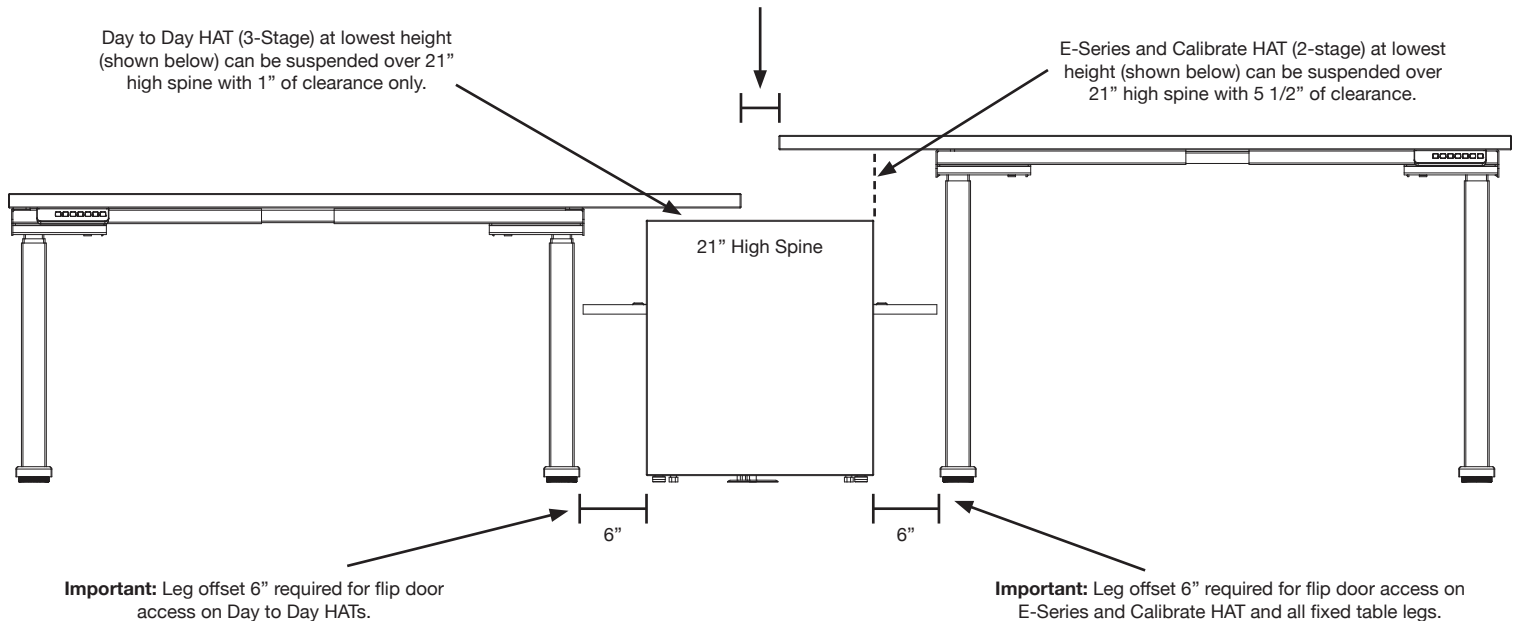

Calibrate Community Product Details

Community Spine Storage Considerations

End Panels must be used to cover spine ends in all cases, even when supported by storage elements.

End Panels must be used to cover spine ends in all cases, even when supported by storage elements.

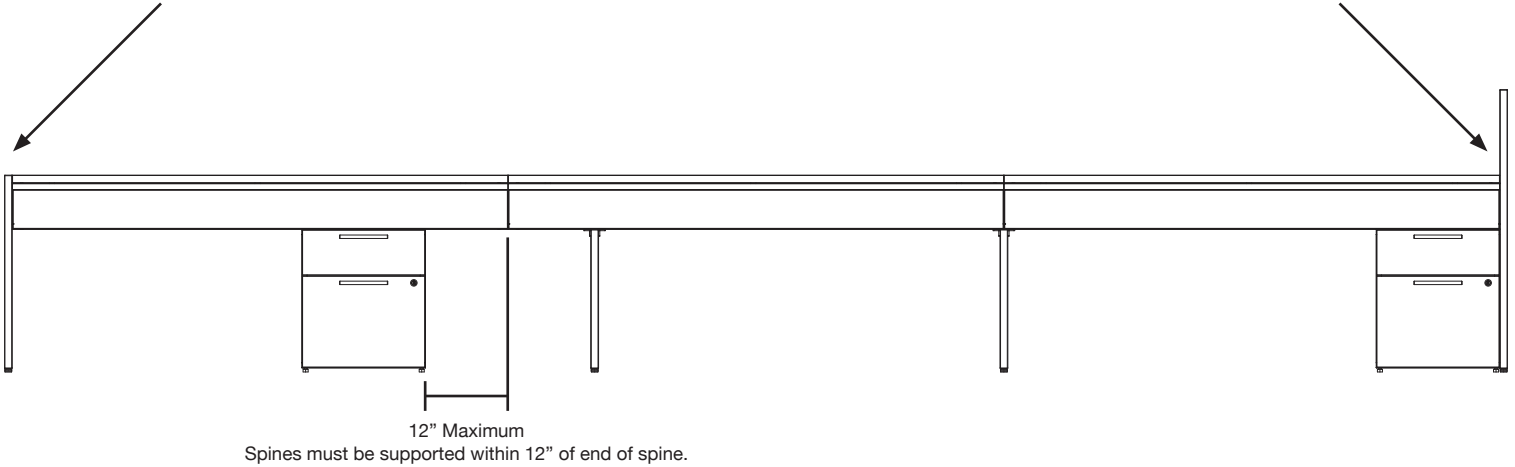

Stack storage must ALWAYS be supported from spines that are directly supported by floor storage or mid supports on at least one side.

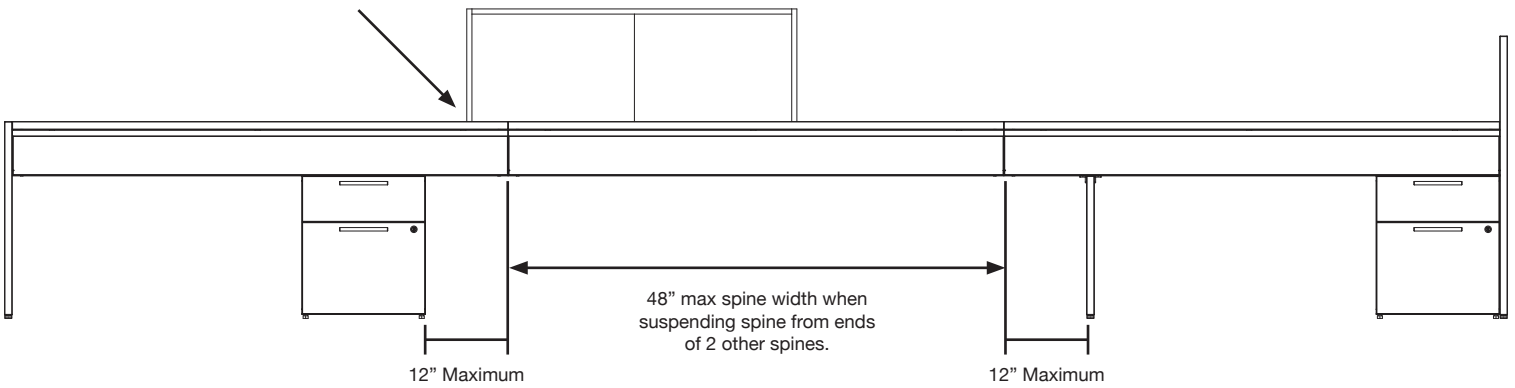

Calibrate Community Product Details

Community Spine Hutch R & S Details

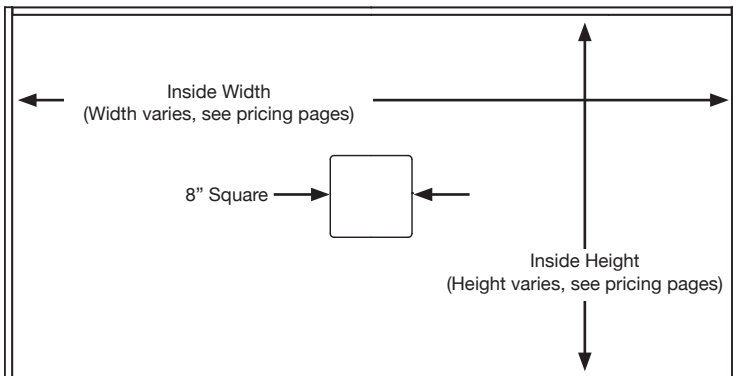

R series hutches have access holes in one side only

Both R and S series hutches are compatible with Hutch A Tackboards

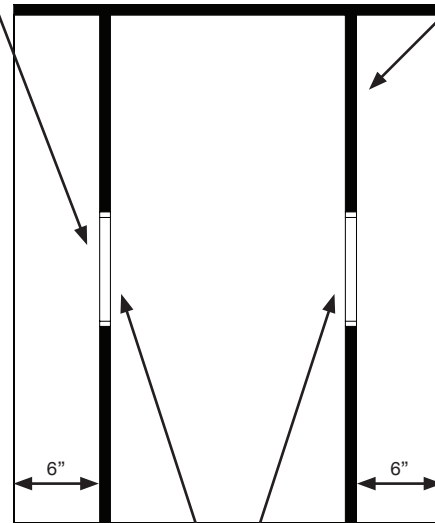

S series hutches have access holes in both sides

Calibrate Community Product Details

Wood Grain Direction

Grain direction runs vertical for all pieces except for the back of 48" wide cabinets, in which case it runs horizontal. Calibrate wood grain is always vertical on storage fronts and doors. Grains run vertically on items under 60" wide. Items over 60" wide have the grain will run horizontally.

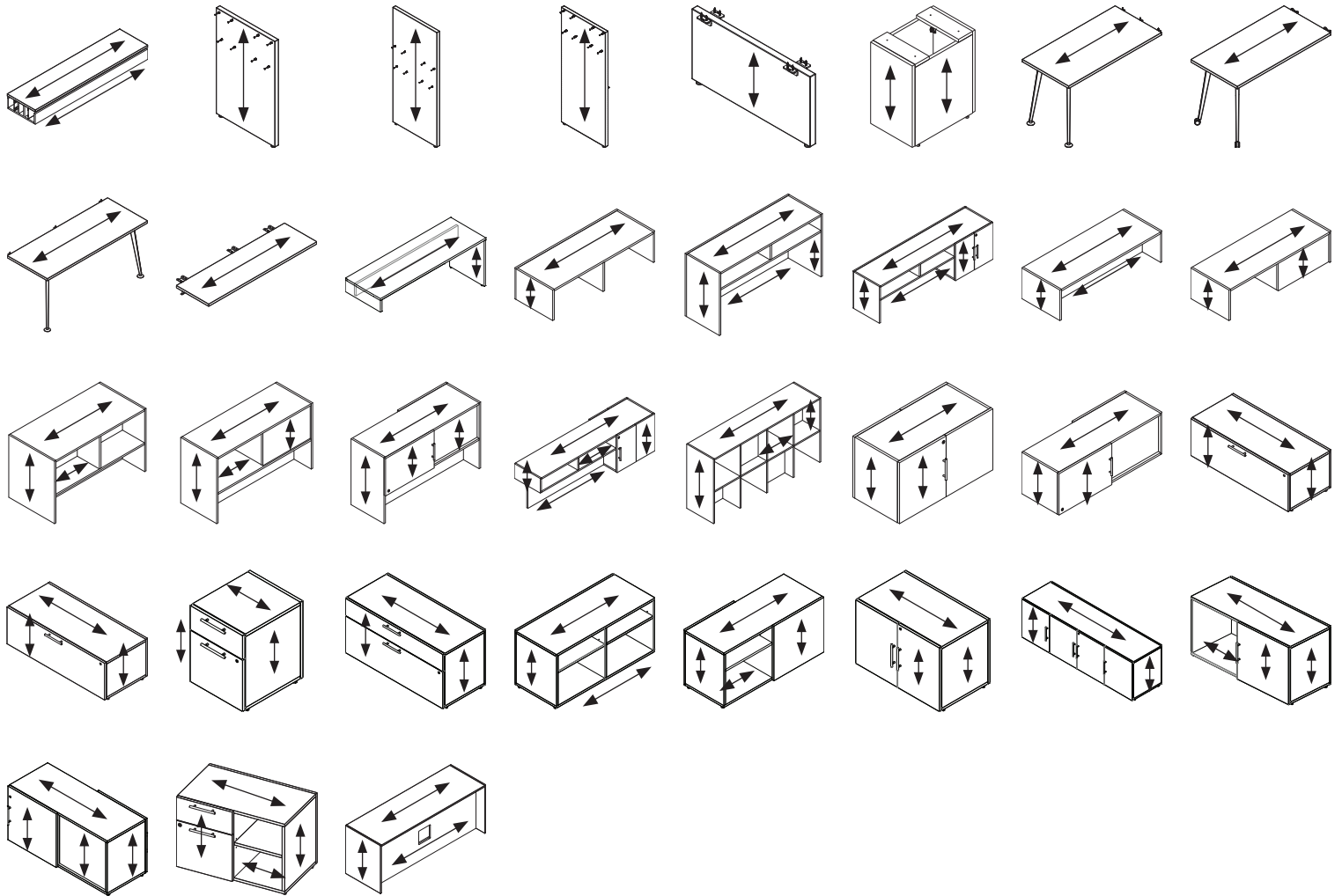

21" High Spine Application with Components

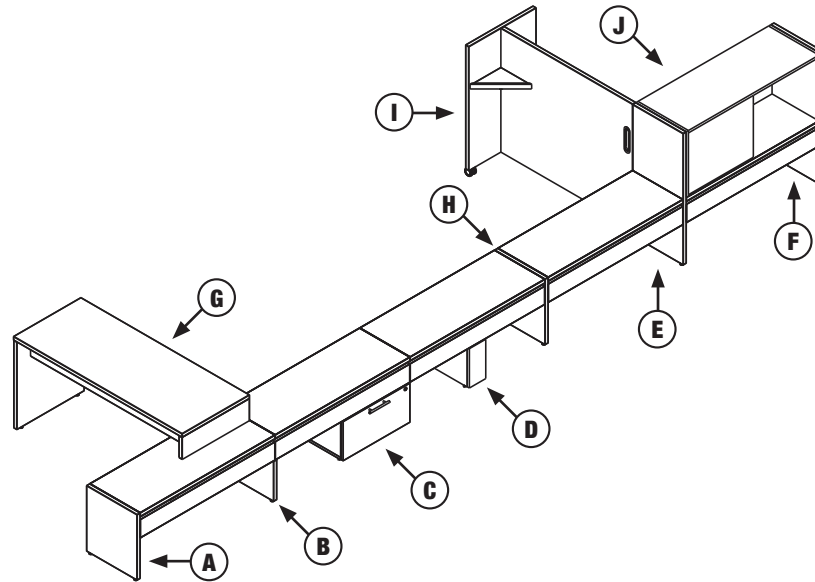

- A. **21" High Top Mount End Panel** - Used at end of spine to support spine flush with top of end panel and finish end of spine. Adds 1 1/8th" to spine length. Specify end panel that matches spine depth chosen.
- B. **13" High Mid Support** - Used to support spine at 21" high at seam between two adjacent spines. Specify end panel that matches spine depth chosen.
- C. **13" High Storage** - Provides lockable personal storage beneath 21" high spine and used to support spine.
- D. **13" High Infeed Base Support** - Has removable front and back panels and an open bottom to provide entrance for electrical and data cables.
- E. **42" High Shared Mid Mount End Panel with 21" High Mount Height** - Supports the ends of 2 spines at 21" high with a section of panel above spine mounting height to act as a finished end for storage or screens or to create a space for adjacent gallery panels and rolling whiteboards. Adds 1 1/8th" to spine length. Specify end panel that matches spine depth chosen.
- F. **42" High Mid Mount End Panel with 21" High Mount Height** - Supports and finishes end of spine with section of panel above spine mounting height to act as a finished end for storage or screens if desired. Adds 1 1/8th" to spine length. Specify end panel that matches spine depth chosen.
- G. **Stack-On Desks** - Available to stack on top of 21 high spines or 21" high storage elements.
- H. **21" High Shared Top Mount End Panel** - Used between 2 spine to support spine flush with top of end panel and to provide a 1 1/8th space between spine for placement of screens and dividers. Adds 1 1/8th" to spine length. End panel has cutout for passing electrical and data cables. Specify end panel that matches spine depth chosen.
- I. **42" High Tri-Wheel Whiteboard/Divider**
- J. **20" High Spine Hutch B Open Right**

Calibrate Community Product Details

29" High Spine Application with Components

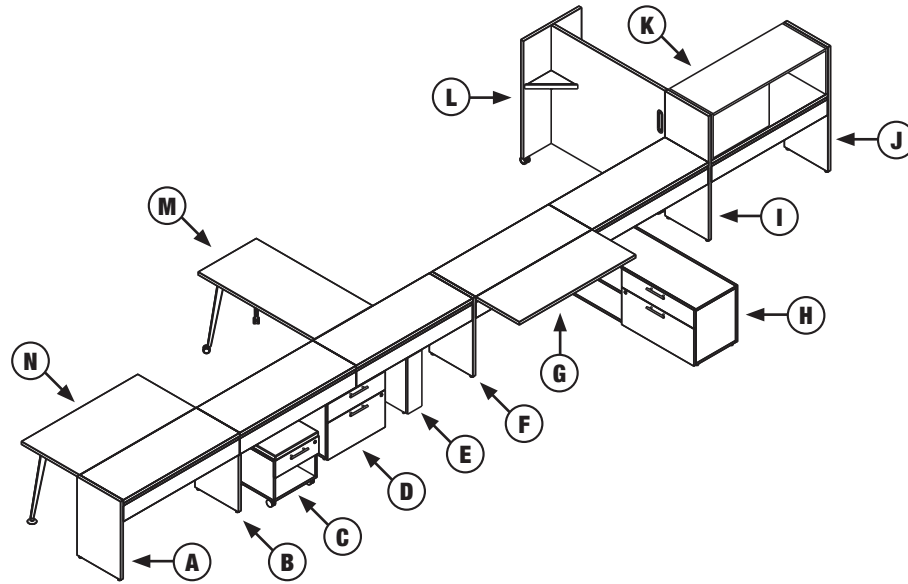

- A. **29" High Top Mount End Panel** - Used at end of spine to support spine flush with top of end panel and finish end of spine. Adds 1 1/8th" to spine length. Specify end panel that matches spine depth chosen.
- B. **21" High Mid Support** - Used to support spine at 29" high at seam between two adjacent spines. Specify end panel that matches spine depth chosen.
- C. **18" High Mobile Storage** - Designed to be stored under 29" high spines.
- D. **21" High Storage** - Can be used to support 29" high spines and are available in many configurations.
- E. **21" High Infeed Base Support** - Has removable front and back panels and an open bottom to provide entrance for electrical and data cables.
- F. **29" High Shared Top Mount End Panel** - Used between 2 spine to support spine flush with top of end panel and to provide a 1 1/8th space between spine for placement of screens and dividers. Adds 1 1/8th" to spine length. End panel has cutout for passing electrical and data cables. Specify end panel that matches spine depth chosen.
- G. **18" Deep Cantilevered Worksurface** - Can be mounted on spines that are supported with Storage below. Cantilevered surface does not impede flip door electrical access.
- H. **21" High Storage** - Can be used to support 29" high spine, shown here turned perpendicular to spine.
- I. **42" High Shared Mid Mount End Panel with 29" High Mount Height** - Supports the ends of 2 spines at 29" high with a section of panel above spine mounting height to act as a finished end for storage or screens or to create a space for adjacent gallery panels and rolling whiteboards. Adds 1 1/8th" to spine length. Specify end panel that matches spine depth chosen.
- J. **42" High Mid Mount End Panel with 29" High Mount Height** - Supports and finishes end of spine with section of panel above spine mounting height to act as a finished end for storage or screens if desired. Adds 1 1/8th" to spine length. Specify end panel that matches spine depth chosen.
- K. **20" High Spine Hutch B Open Right** - Used for storage and space division.
- L. **42" High Tri-Wheel Whiteboard/Divider**
- M. **Sliding Run-off Surfaces and Fixed Run-off Surfaces** - Can be specified for 29" high spines and mount with short side parallel to spine. Sliding Run-off Surfaces can be specified with glides or casters. Track for mounting ordered separately based on spine width. Sliding surfaces can slide along spine continuously as long as tracks are ordered for adjacent spines. Sliding surfaces CANNOT slide past Shared End Panels. Fixed Run-Off Surfaces are stationary and do not require track for mounting. Run-off surfaces do not impede flip door access to electrical.
- N. **Fixed Spine Surfaces** - Mount with long side parallel to spine and are supported at front with 2 legs. Fixed Spine Surfaces do not impede flip door access to electrical.

Typical 1

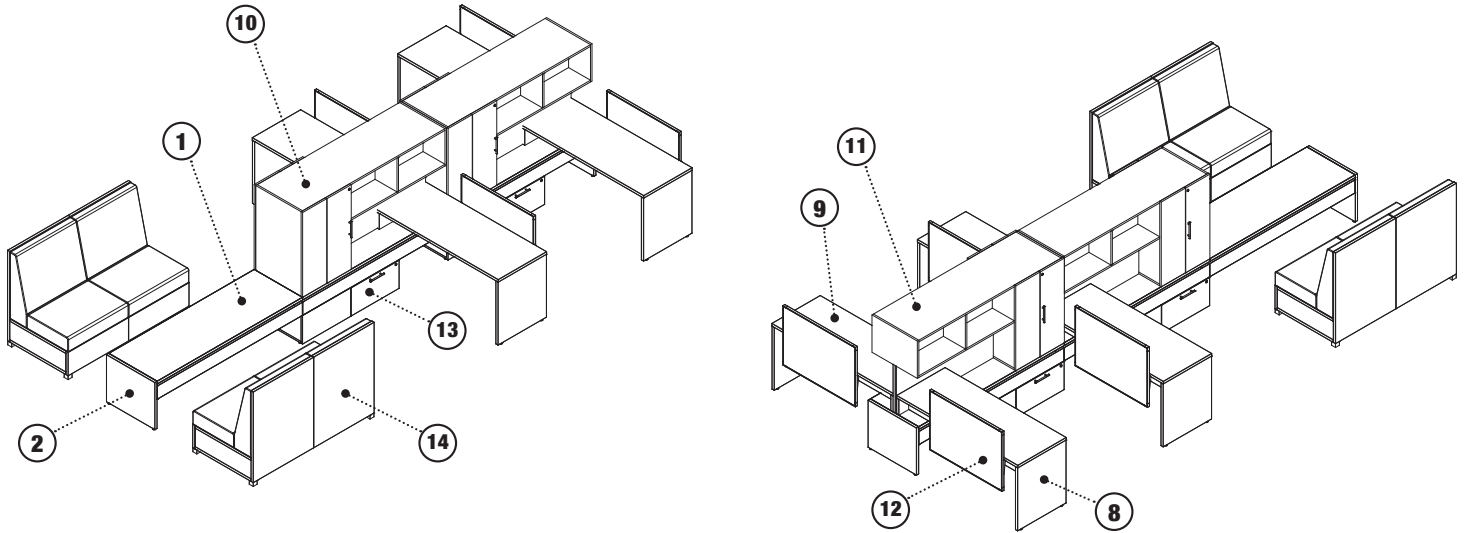

Description	Model Number	Quantity	Notes
1. Double Sided Powered Spine 72" Wide x 24" Deep	C-COMSP2-7224	3x	
2. Top Mount End Panels	C-CEP2421	2x	
3. Duplex Outlets - Line 1	E-MW8W4DO1	6x	
4. USB Outlets - Line 2	E-UN8W4USB02	6x	
5. Duplex Outlets - Line 4	E-MW8W4DO4	6x	
6. Electrical Jumpers 61" Long	E-MW8W4PJ42	2x	
7. Side-Mounted Base Infeed	E-UN8W4BIFS	1x	
8. Stack-On Desk Left Modesty 28" High x 60" Wide x 24" Deep	X-SODL286024	2x	
9. Stack-On Desk Right Modesty 28" High x 60" Wide x 24" Deep	X-SODR286024	2x	
10. Spine Hutch H Full Panel 36" High x 72" Wide x 24" Deep	C-CSH367224HF	2x	
11. Fabric Tackboard for Spine Hutch H (Full Panel) 36" High x 72" Wide	C-CTACKF3672HF	4x	
12. Fabric/Whiteboard/Laminate/Vinyl Partial Modesty Undersurface Mount Slimline Screen 26" High x 36" Wide	O-SMH2636	4x	See Oxygen Price List for details.
13. 13" High Storage with Bottom and Hidden Top Box Drawer 24" Wide x 24" Deep	C-CLATB2424	4x	
14. Configurable LB Lounge Solid Base 2-Seater	F-SSS426030C	2x	See Seating Price List for details.

Calibrate Community Typicals

Typical 2

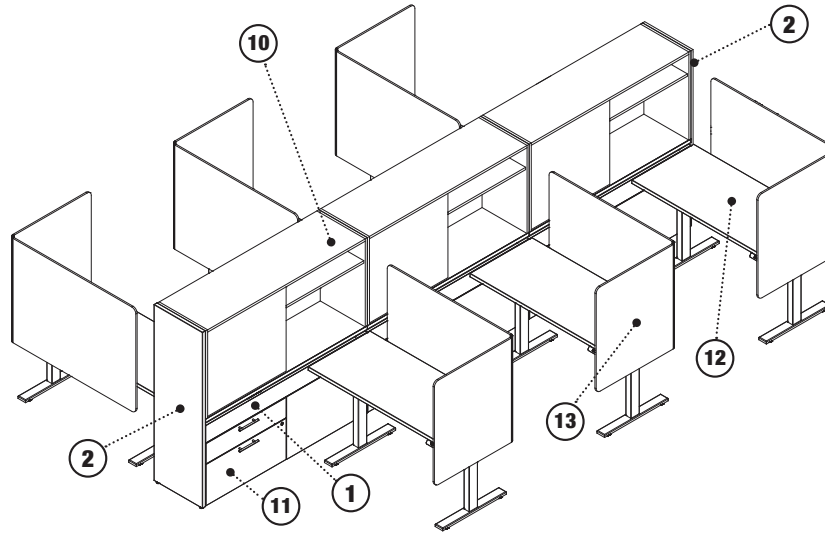

Description	Model Number	Quantity	Notes
1. Double Sided Powered Spine 60" Wide x 18" Deep	C-COMSP2-6018	3x	
2. Mid Mount End Panels 18" Deep x 58" High	C-CEP185829	2x	
3. Duplex Outlets - Line 1	E-MW8W4DO1	6x	
4. Duplex Outlets - Line 2	E-MW8W4DO2	6x	
5. Duplex Outlets - Line 4	E-MW8W4DO4	6x	
6. Electrical Jumpers 48" Long	E-UN8W4J48	2x	
7. Infeed Base Support 18" Deep x 6" Wide x 21" High	C-CIBS180621	1x	
8. Single Gang Plate Adapters	E-DJA	6x	
9. Side-Mounted Base Infeed	E-UN8W4BIFS	1x	
10. Spine Hutch B Open Right 28" High x 72" Wide x 18" Deep	C-CSH287218BR	3x	
11. BF Lateral 21" High x 30" Wide x 18" Deep	X-PLAT2D3018	1x	
11. BF Lateral 21" High x 36" Wide x 18" Deep	X-PLAT2D3618	5x	
12. E Series 2mm Edge Rectangular Table with Height Adjustable Bases 24" Deep x 54" Wide x 29" High	T-RCR245429HG	6x	See Tables Price List for details.
13. PET L-Wrap Partial Modesty Under Surface Mount Lite Screens Right Hand 34" High x 48" Wide x 24" Deep	Y-5M4J2R342448B	6x	See Tables Price List for details.

Typical 3

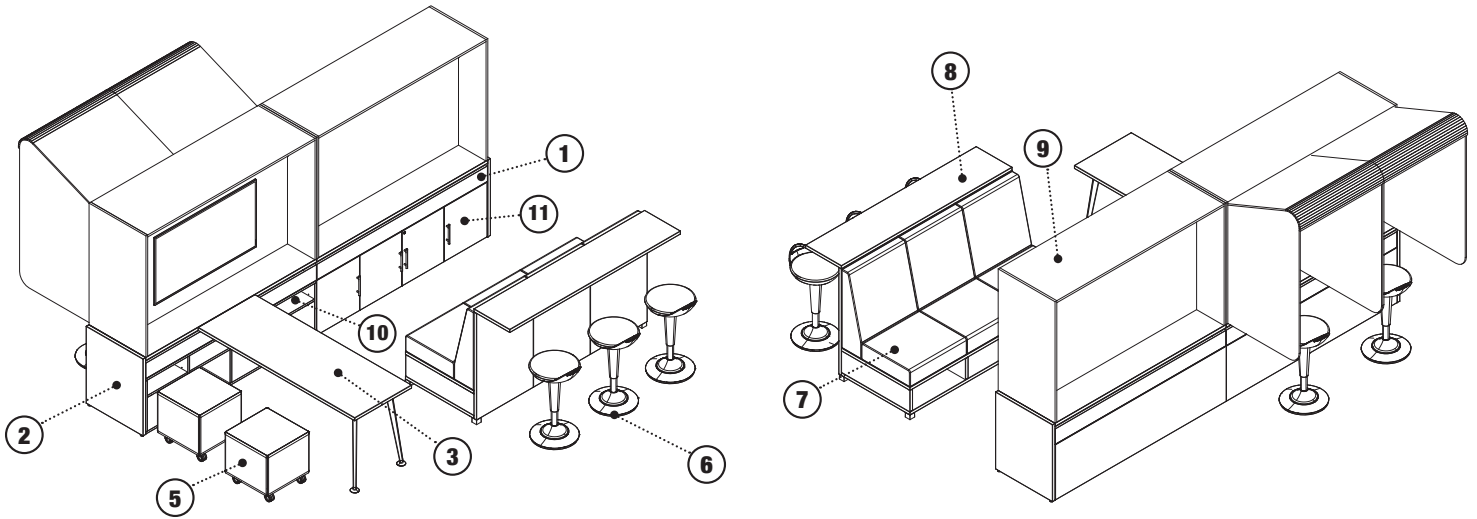

Description	Model Number	Quantity	Notes
1. Double Sided Powered Spine 72" Wide x 24" Deep	C-COMSP2-7224	2x	
2. Top Mount End Panels 24" Deep x 29" High	C-CEP2429	2x	
3. 2mm Edge Sliding Run-Off 29" High x 66" Wide x 24" Deep	C-CSRR2466G	1x	
4. Sliding Run-Off Track 72" Wide	C-CRRT72	1x	
5. Volker Cube 18" High x 18" Wide x 18" Deep	F-CUBE181818	2x	See Seating Price List for details.
6. Rutland Perch	6470C	3x	See Seating Price List for details.
7. Configurable LB Lounge Solid Base 3-Seater 42" High x 72" Wide x 30" Deep	F-SSS427230C	1x	See Seating Price List for details.
8. LB Ledge 13" Deep x 72" Wide	F-LBLL1372	1x	See Seating Price List for details.
9. Community Spine Hutch A 44" High x 72" Wide x 24" Deep	C-CSH447224A	2x	Coming soon.
10. Floor Bookcase 21" High x 72" Wide x 24" Deep	X-CBC207224	1x	
11. Four Door Cabinet 21" High x 72" Wide x 24" Deep	X-4DC722421	1x	Coming soon.
12. Duplex Outlets - Line 1	E-MW8W4DO1	4x	
13. Duplex Outlets - Line 2	E-UN8W4USB02	4x	
14. Duplex Outlets - Line 4	E-MW8W4DO4	4x	
15. Electrical Jumpers 61" Long	E-MW8W4PJ42	1x	
16. Side-Mounted Base Infeeds	E-UN8W4BIFS	1x	

Calibrate Community Typicals

Typical 4

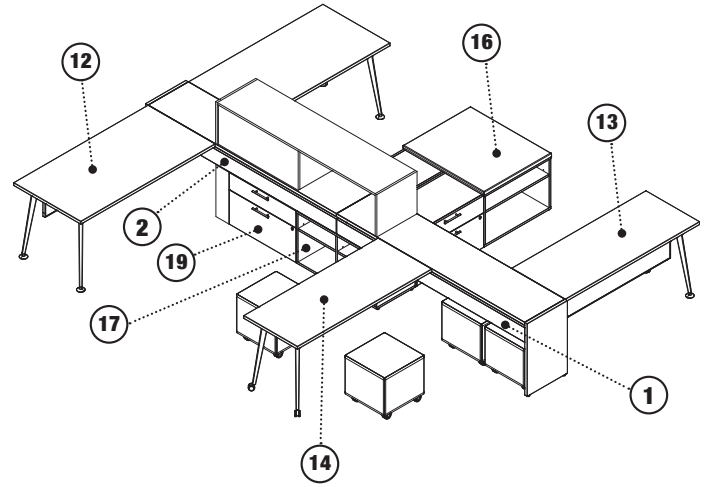
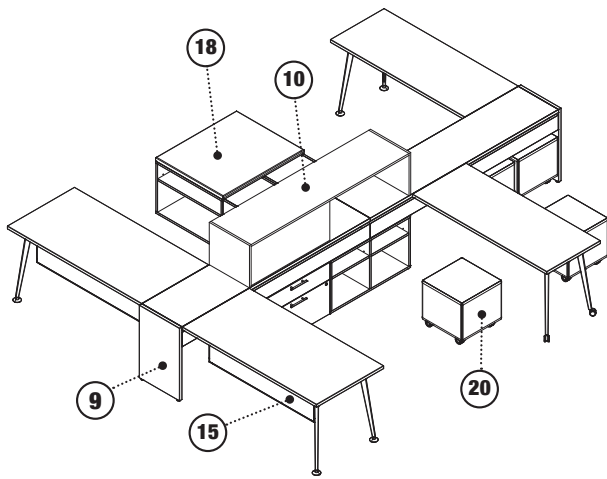

Description	Model Number	Quantity	Notes
1. Double Sided Powered Spine 84" Wide x 18" Deep	C-COMSP2-8418	2x	
2. Infeed Base Support 18" Deep x 6" Wide x 21" High	C-CIBS180621	1x	
3. Side-Mounted Base Infeed	E-UN8W4BIFS	1x	
4. Duplex Outlets - Line 1	E-MW8W4DO1	4x	
5. USB Outlets - Line 2	E-UN8W4USB02	4x	
6. Duplex Outlets - Line 4	E-MW8W4DO4	4x	
7. Single Gang Plate Adapters	E-DJA	4x	
8. Electrical Jumpers 69" Long	E-MW8W4PJ48E	1x	
9. Top Mount End Panels 18" Deep x 29" High	C-CEP1829	2x	
10. Spine Hutch B Open Right 12" High x 72" Wide x 18" Deep	C-CSH127218BR	1x	
11. Sliding Run-Off Tracks 84" Wide	C-CRRT84	4x	
12. 2mm Edge Sliding Run-Off w/ Glides 29" High x 60" Wide x 30" Deep	C-CSRR3060G	2x	
13. 2mm Edge Sliding Run-Off w/ Glides 29" High x 60" Wide x 24" Deep	C-CSRR2460G	1x	
14. 2mm Edge Sliding Run-Off w/ Casters 29" High x 60" Wide x 24" Deep	C-CSRR2460C	1x	
15. Front/Rear Surface Mount Slimline Screens 12" High x 48" Wide	Y-6R1A1U1248B	3x	See Screens Price List for details.
16. Floor Bookcases 21" High x 30" Wide x 18" Deep	X-CBC2030	2x	
17. Floor Bookcases 21" High x 36" Wide x 18" Deep	X-CBC2036	1x	
18. Shared Credenza Cushion 36" Deep x 30" Wide	S-BCUSH3630	1x	See Calibrate Price List for details.
19. BF Lateral 21" High x 30" Wide x 18" Deep	X-PLAT2D3018	3x	
20. Volker Cube 18" High x 18" Wide x 18" Deep	F-CUBE181818	4x	See Seating Price List for details.

Typical 5

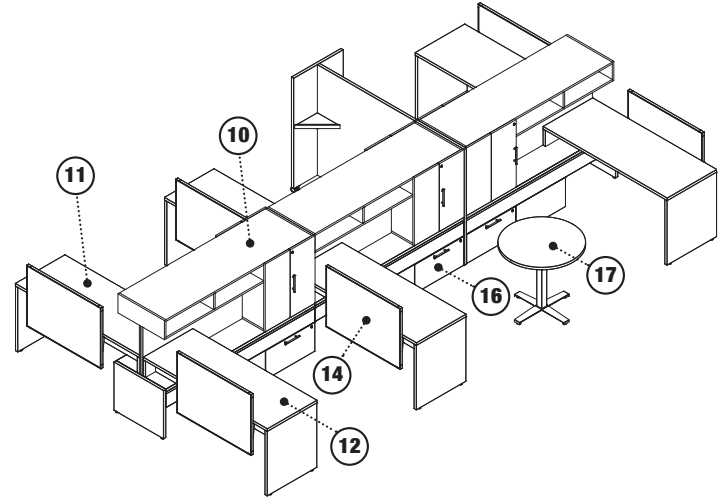
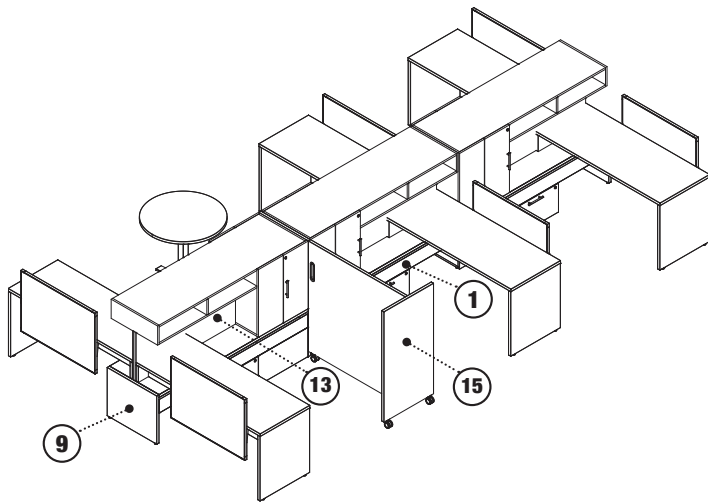

Description	Model Number	Quantity	Notes
1. Double Sided Powered Spine 72" Wide x 24" Deep	C-COMSP2-7224	3x	
2. Side-Mounted Base Infeed	E-UN8W4BIFS	1x	
3. Single Gang Plate Adapters	E-DJA	6x	
4. Duplex Outlets - Line 1	E-MW8W4DO1	6x	
5. USB Outlets - Line 2	E-UN8W4USB02	6x	
6. Duplex Outlets - Line 4	E-MW8W4DO4	6x	
8. Electrical Jumpers 61" Long	E-MW8W4PJ42	2x	
9. Top Mount End Panels 24" Deep x 21" High	C-CEP2421	2x	
10. Spine Hutch F Full Panel 28" High x 72" Wide x 24" Deep	C-CSH287224HF	3x	
11. Stack-On Desk Right Modesty 29" High x 60" Wide x 24" Deep	X-SODR286024	3x	
12. Stack-On Desk Left Modesty 29" High x 60" Wide x 24" Deep	X-SODL286024	3x	
13. Fabric Tackboard for Spine Hutch H Full Panel 28" High x 72" Wide	C-CTACKF2872HF	6x	
14. Fabric/Whiteboard/Laminate/Vinyl Partial Modesty Undersurface Mount Slimline Screen 26" High x 36" Wide	O-SMH2636	6x	See Oxygen Price List for details.
15. Tri-Wheel Mobile Laminate Whiteboard/Divider 24" Deep x 54" Wide x 50" High	A-TWWB502454	1x	See Accessories Price List for details.
16. 13" High Storage with Bottom and Hidden Top Box Drawer 24" Wide x 24" Deep	C-CLATB2424	6x	
17. 2mm Edge Round Table with Tapered Post Legs 36" Deep x 29" High	T-RDR3629TPG	1x	See Tables Price List for details.

Calibrate Community Typicals

Typical 6

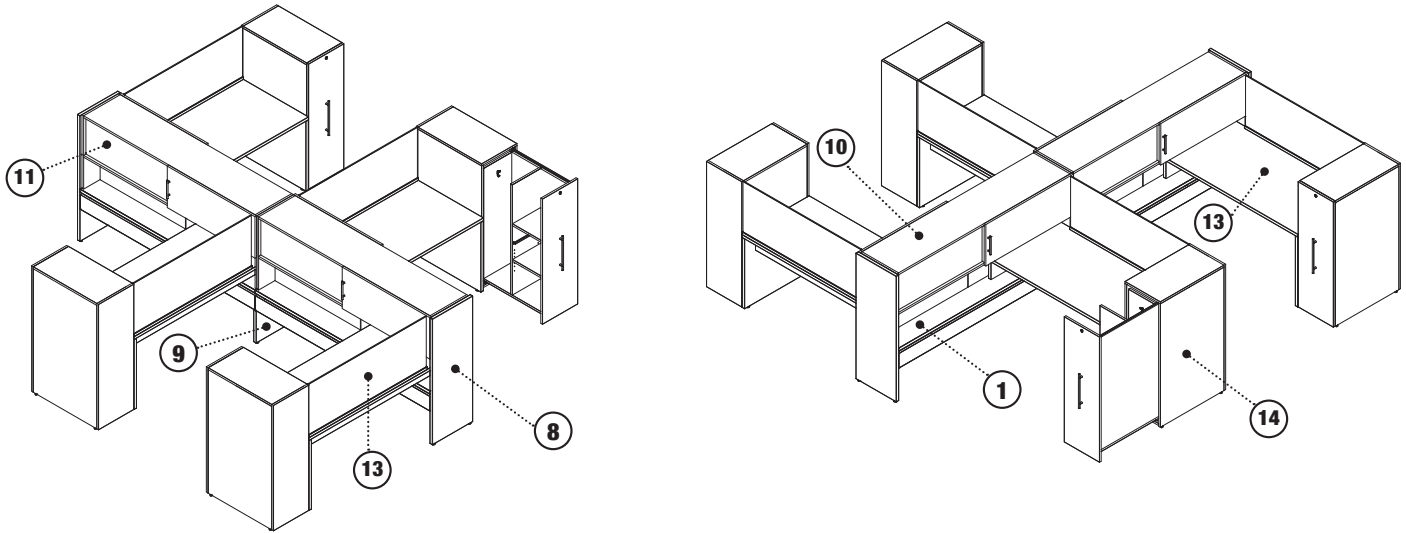

Description	Model Number	Quantity	Notes
1. Double Sided Powered Spine 78" Wide x 18" Deep	C-COMSP2-7818	2x	
2. Single Gang Plate Adapters	E-DJA	4x	
3. Duplex Outlets - Line 1	E-MW8W4DO1	4x	
4. USB Outlets - Line 2	E-UN8W4USB02	4x	
5. Duplex Outlets - Line 4	E-MW8W4DO4	4x	
6. Side-Mounted Base Infeed	E-UN8W4BIFS	1x	
7. Electrical Jumpers 67" Long	E-MW8W4PJ48	1x	
8. Mid Mount End Panels 18" Deep x 50" High	C-CEP185021	2x	
9. Mid Support 18" Deep x 13" High	C-CMSP1821	1x	
10. Spine Hutch E Door Right 28" High x 78" Wide x 18" Deep	C-CSH287818ER	2x	
11. PET Tackboard for Spine Hutch E 28" High x 42" Wide	C-CTACK2842E	4x	
12. Stack-On Desks Right Modesty 29" High x 60" Wide x 30" High	X-SODR286030	4x	
13. Glass 3/8" Front/Rear Surface Mount Channel Screen 20" High x 54" Wide	Y-4R2H1U2054B	4x	See Aloft Price List for details.
14. Side Access Roll Out/Pantry Tower Right Handed 50" High x 15.75" Wide x 30" Deep	X-SARTR501530	4x	See Calibrate Price List for details.

Typical 7

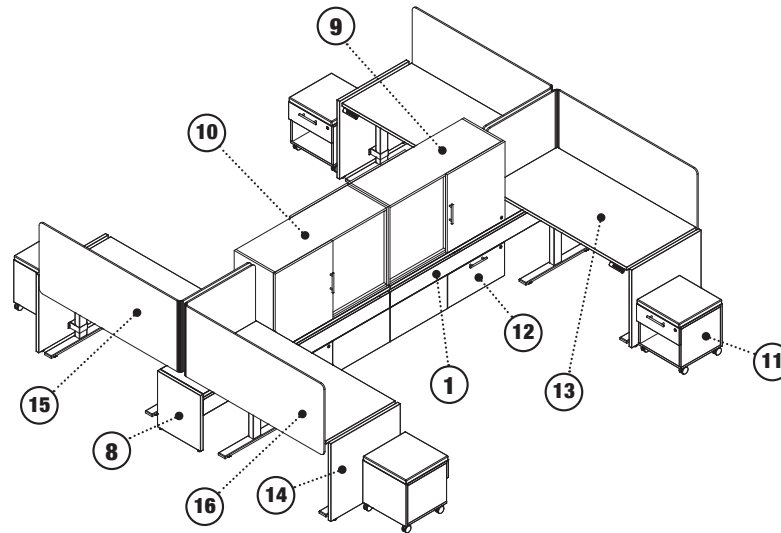

Description	Model Number	Quantity	Notes
1. Double Sided Powered Spine 78" Wide x 18" Deep	C-COMSP2-7818	2x	
2. Single Gang Plate Adapters	E-DJA	4x	
3. Duplex Outlets - Line 1	E-MW8W4DO1	4x	
4. USB Outlets - Line 2	E-UN8W4USB02	4x	
5. Duplex Outlets - Line 4	E-MW8W4DO4	4x	
6. Electrical Jumpers 67" Long	E-MW8W4PJ48	1x	
7. Side-Mounted Base Infeed	E-UN8W4BIFS	1x	
8. Top Mount End Panels 18" Deep x 21" High	C-CEP1821	2x	
9. Spine Cabinet M Door Right 28" High x 48" Wide x 18" Deep	C-CSC284818MR	1x	
10. Spine Cabinet M Door Left 28" High x 48" Wide x 18" Deep	C-CSC284818ML	1x	
11. Bottom Cubby Box Mobile Pedestal	C-PCFLCN181818	4x	
12. 13" High Storage with Single Bottom Box Drawer 24" Wide x 18" Deep	C-CLATF1824	4x	
13. E Series 2mm Edge Rectangular Table with Height Adjustable Bases 30" Deep x 60" Wide x 29" High	T-RCR306029HG	4x	See Tables Price List for details.
14. End Panels for Day-to-Day Tables with Height Adjustable Bases 30" Deep x 29" High	T-EPHAT2930	4x	See Tables Price List for details.
15. PET L-Wrap Partial Modesty Under Surface Mount Lite Screens Left Hand 26" High x 60" Wide x 30" Deep	Y-5M4J2L263060B	2x	See Tables Price List for details.
16. PET L-Wrap Partial Modesty Under Surface Mount Lite Screens Right Hand 26" High x 60" Wide x 30" Deep	Y-5M4J2R263060B	2x	See Tables Price List for details.

Calibrate Community Typicals

Typical 8

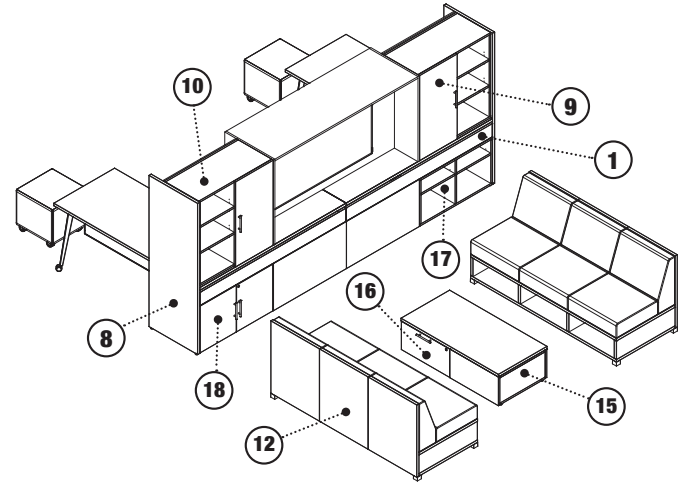
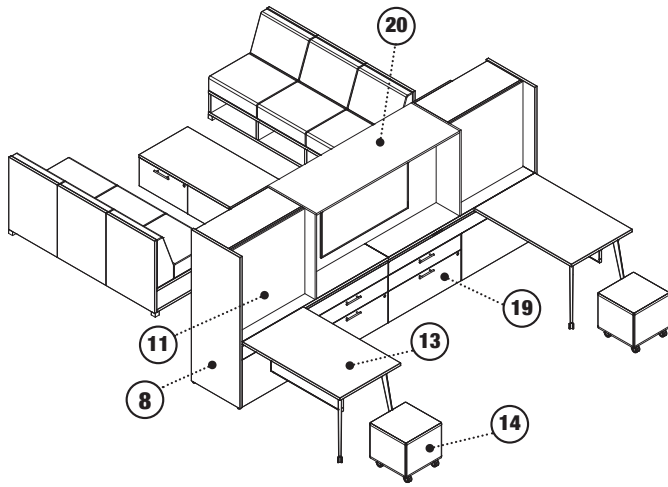

Description	Model Number	Quantity	Notes
1. Single Sided Powered Spine 72" Wide x 24" Deep	C-COMSP1-7224	2x	
2. Single Gang Plate Adapters	E-DJA	2x	
3. Duplex Outlets - Line 1	E-MW8W4DO1	2x	
4. USB Outlets - Line 2	E-UN8W4USB02	2x	
5. USB Outlets - Line 4	E-UN8W4USB04	2x	
6. Electrical Jumpers 61" Long	E-MW8W4PJ42	1x	
7. Side-Mounted Base Infeeds	E-UN8W4BIFS	1x	
8. Mid Mount End Panels 24" Deep x 66" High	C-CEP246629	2x	
9. Stack-On Bookcase with Sliding Doors Left Handed 37" High x 36" Wide x 14" Deep	X-SOSDL3736	1x	See Calibrate Price List for details.
10. Stack-On Bookcase with Sliding Doors Right Handed 37" High x 36" Wide x 14" Deep	X-SOSDR3736	1x	See Calibrate Price List for details.
11. Vertical Wall Mounted Tackboard 37" High x 36" Wide	X-TACKSW3736	2x	See Calibrate Price List for details.
12. Configurable LB Lounge Open Base 3-Seater 34" High x 72" Wide x 30" Deep	F-SSC347230C	2x	See Seating Price List for details.
13. 2mm Edge Sliding Run-Off w/ Casters 29" High x 48" Wide x 30" Deep	C-CSRR3048C	2x	
14. Volker Cube 18" High x 18" Wide x 18" Deep	F-CUBE181818	2x	See Seating Price List for details.
15. Rectangular Worksurface 24" Deep x 48" Wide	W-WS2448	1x	See Worksurfaces Price List for details.
16. 13" High Storage with Single Bottom Box Drawer 24" Wide x 24" Deep	C-CLATF2424	2x	
17. Floor Bookcase 21" High x 36" Wide x 24" Deep	X-CBC203624	1x	See Calibrate Price List for details.
18. Two Door Cabinet 21" High x 36" Wide x 24" Deep	X-DDC362421	1x	Coming soon.
19. BF Laterals 21" High x 36" Wide x 24" Deep	X-PLAT2D3624	2x	
20. Spine Hutch A 36" High x 72" Wide x 24" Deep	C-CSH367224A	1x	
21. Sliding Run-Off Tracks 72" Wide	C-CRR72	2x	

Typical 9

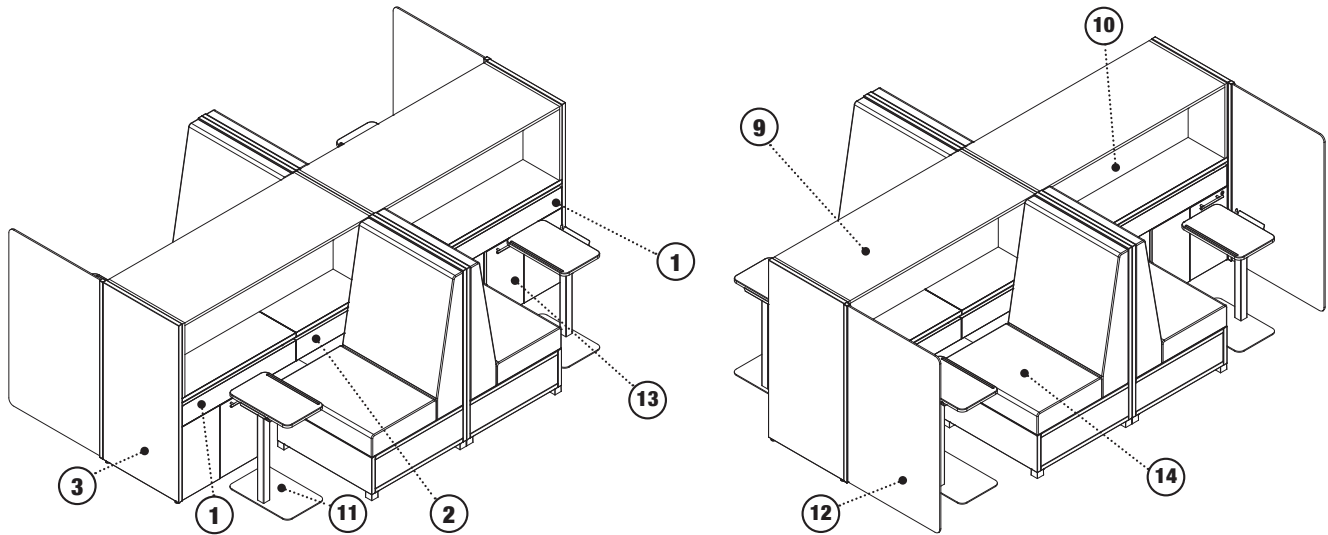

Description	Model Number	Quantity	Notes
1. Double Sided Powered Spine 36" Wide x 24" Deep	C-COMSP2-3624	2x	
2. Double Sided Powered Spine 48" Wide x 24" Deep	C-COMSP2-4824	1x	
3. Mid Mount End Panels 24" Deep x 50" High	C-CEP245029	2x	
4. Side-Mounted Base Infeeds	E-UN8W4BIFS	1x	
5. Electrical Jumpers 33" Long	E-HM8W4PJ24	2x	
6. USB Outlets - Line 1	E-UN8W4USB01	4x	
7. Duplex Outlets - Line 4	E-MW8W4DO4	4x	
8. Infeed Base Support 24" Deep x 12" Wide x 21" High	C-CIBS241221	1x	Centered under spine in center.
9. Spine Hutch A 20" High x 60" Wide x 24" Deep	C-CSH206024A	2x	
10. PET Tackboard for Spine Hutch A 20" High x 60" Wide	C-CTACK2060A	4x	
11. Laptop Table	T-LT	4x	See Tables Price List for details.
12. PET Gallery Panel Side Mount Channel Screens 50" High x 30" Wide	Y-5G2R1U5030B	2x	Coming soon.
13. Hidden Drawer BF Pedestal 21" High x 12" Wide x 24" Deep	X-BFPH211224	4x	
14. Configurable LB Lounge Solid Base 1-Seater 50" High x 30" Wide x 30" Deep	F-SSS503030C	4x	See Seating Price List for details.

Calibrate Community Typicals

Typical 10

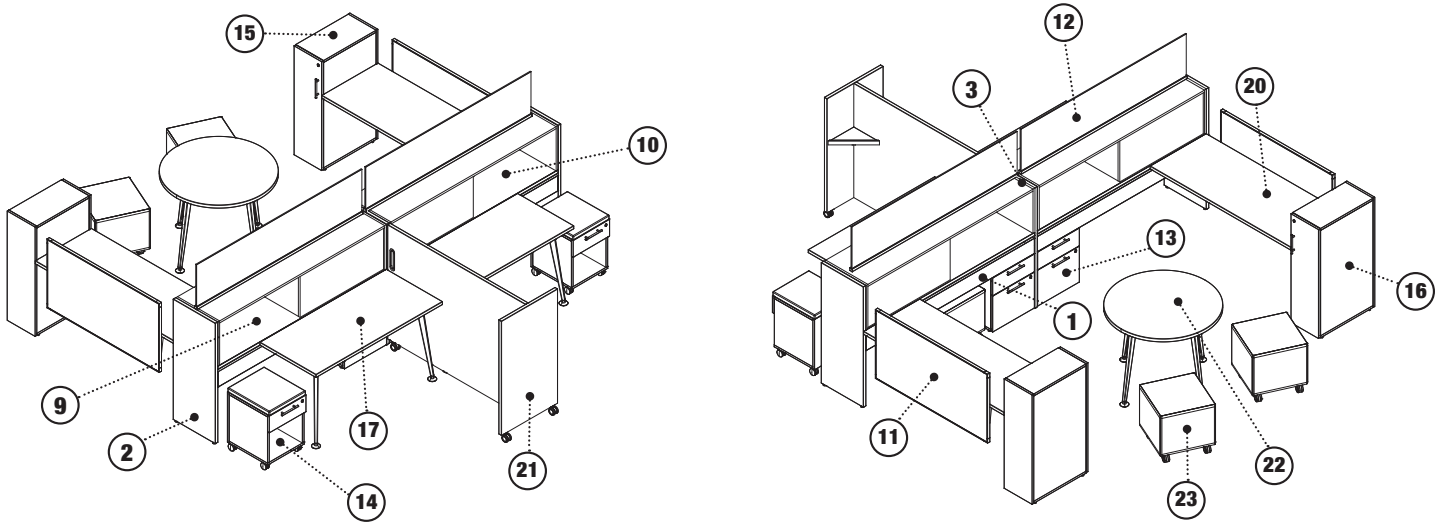

Description	Model Number	Quantity	Notes
1. Double Sided Powered Spine 72" Wide x 18" Deep	C-COMSP2-7218	2x	
2. Mid Mount End Panels 18" Deep x 46" Wide	C-CEP184629	2x	
3. Shared Mid Mount End Panels 18" Deep x 46" Wide	C-CEPMS184629	1x	
4. Duplex Outlets - Line 1	E-MW8W4DO1	4x	
5. Duplex Outlets - Line 2	E-MW8W4DO2	4x	
6. Single Gang Plate Adapters	E-DJA	4x	
7. Electrical Jumpers 61" Long	E-MW8W4PJ42	1x	
8. Side-Mounted Base Infeeds	E-UN8W4BIFS	1x	
9. Spine Hutch B Open Left 16" High x 72" Wide x 18" Deep	C-CSH167218BL	1x	
10. Spine Hutch B Open Right 16" High x 72" Wide x 18" Deep	C-CSH167218BR	1x	
11. Fabric/Whiteboard/Laminate/Vinyl Partial Modesty Undersurface Mount Slimline Screen 26" High x 48" Wide	O-SMH2648	2x	See Oxygen Price List for details.
12. Glass 3/8" Panel Top Surface Mount Channel Scree 16" High x 72" Wide	Y-4P2A1U1672B	2x	See Screens Price List for details.
13. BF Pedestals 21" High x 18" Wide x 18" Deep	X-BFPFS182118	2x	
14. Bottom Cubbie Box Mobile Pedestal with Cushion 21" High x 16" Wide x 18" Deep	C-PCFLCC162118	2x	Coming soon.
15. Single Door Cabinets Left Hinge 46" High x 12" Wide x 24" Deep	X-SDCL4624	1x	Coming soon.
16. Single Door Cabinets Right Hinge 46" High x 12" Wide x 24" Deep	X-SDCR4624	1x	Coming soon.
17. 2mm Edge Fixed Spine Surface with Tapered Legs 29" High x 54" Wide x 24" Deep	X-DROR2454TS	2x	
18. U-Channel 48" Wide	WPS-VC48	2x	See Support & Storage Price List for details.
19. Worksurface Support Bracket	O-WSLB	2x	See Calibrate Price List for details.
20. Rectangular Worksurface 24" Deep x 48" Wide	W-WS2460	2x	See Worksurface Price List for details.
21. Tri-Wheel Mobile Laminate Whiteboard/Divider 24" Deep x 60" Wide x 46" High	A-TWWB462460	1x	See Accessories Price List for details.
22. 2mm Edge Round Table with Tapered Post Legs 36" Deep x 29" High	T-RDR3629TPG	1x	See Tables Price List for details.
23. Volker Cube 18" High x 18" Wide x 18" Deep	F-CUBE181818	2x	See Seating Price List for details.

Typical 11

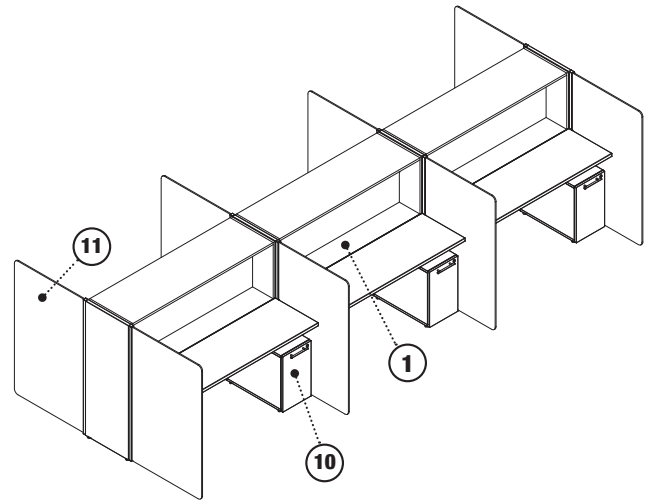
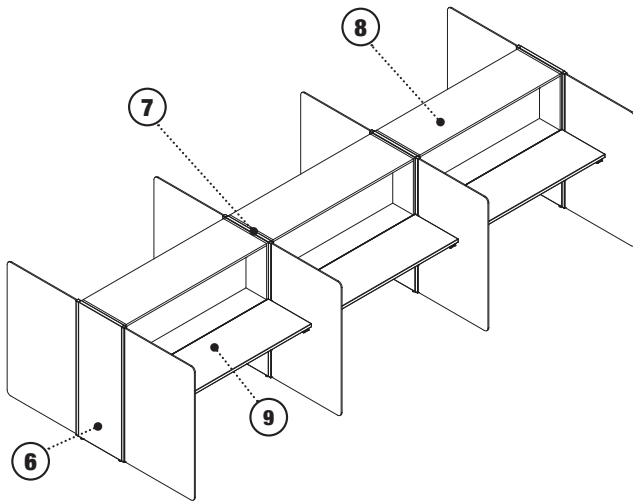

Description	Model Number	Quantity	Notes
1. Double Sided Powered Spine 60" Wide x 18" Deep	C-COMSP2-6018	3x	
2. USB Outlets - Line 1	E-UN8W4USB01	6x	
3. Duplex Outlets - Line 4	E-MW8W4DO4	6x	
4. Electrical Jumpers 48" Long	E-UN8W4J48	2x	
5. Side-Mounted Base Infeeds	E-UN8W4BIFS	1x	
6. Mid Mount End Panels 18" Deep x 50" High	C-CEP185029	2x	
7. Shared Mid Mount End Panels 18" Deep x 50" Wide	C-CEPMS185029	2x	
8. Spine Hutch A 20" High x 60" Wide x 18" Deep	C-CSH206018A	3x	
9. 2mm Edge Cantilevered Spine Surface 29" High x 60" Wide x 18" Deep	C-CCSSR1860	6x	
10. Hidden Drawer BF Pedestals 21" High x 12" Wide x 24" Deep	X-BFPH211224	6x	
11. PET Gallery Panel Side Mount Channel Screens 50" High x 30" Wide	Y-5G2R1U5030B	6	Coming soon.

Calibrate Community Typicals

Typical 12

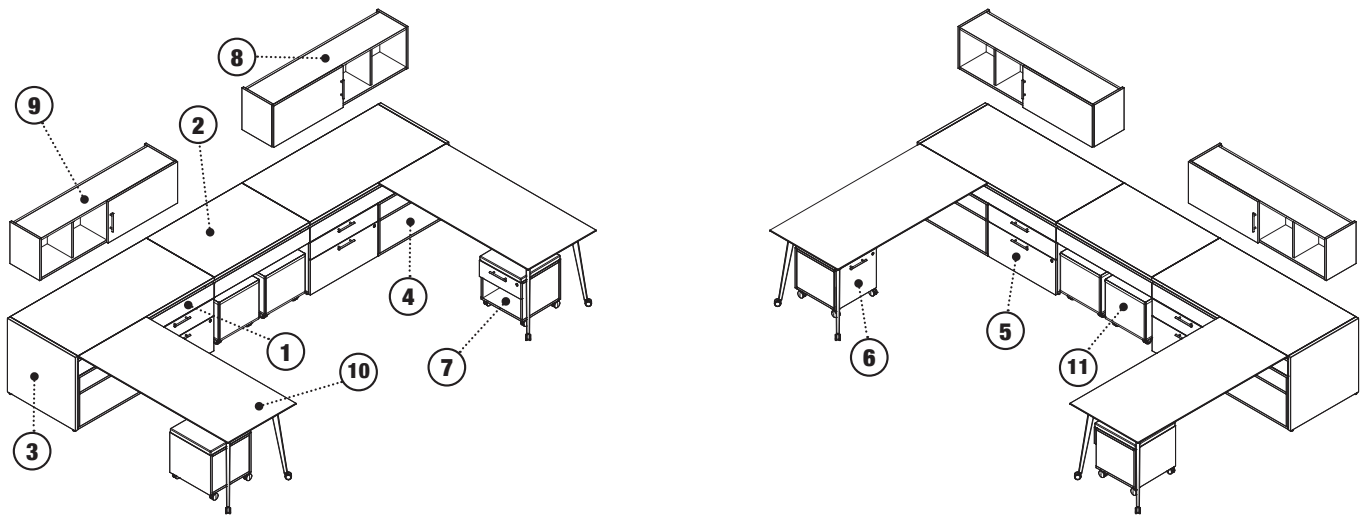

Description	Model Number	Quantity	Notes
1. Single Sided Powered Spine 60" Wide x 30" Deep	C-COMSP1-6030	2x	
2. Single Sided Powered Spine 42" Wide x 30" Deep	C-COMSP1-4230	1x	
3. Top Mount End Panels 30" Deep x 29" High	C-CEP3029	2x	
4. Floor Bookcases 21" High x 30" Wide x 24" Deep	X-CBC203024	2x	
5. BF Laterals 21" High x 30" Wide x 24" Deep	X-PLAT2D3024	2x	
6. Hidden Drawer BF Pedestal on Casters with Cushion 21" High x 16" Wide x 18" Deep	C-BFPDHM16	1x	See Calibrate Price List for details.
7. Bottom Cubbie Box Mobile Pedestal with Cushion 21" High x 16" Wide x 18" Deep	C-PCFLCC162118	1x	See Calibrate Price List for details.
8. Wall Mounted Overhead Storage with Sliding Doors Left-Side Lock 16" High x 60" Wide x 14" Deep	C-OWMS166014LL	1x	See Calibrate Price List for details.
9. Wall Mounted Overhead Storage with Sliding Doors Right-Side Lock 16" High x 60" Wide x 14" Deep	C-OWMS166014RL	1x	
10. Knife Edge Sliding Run-Offs with Tapered Legs 29" High x 66" Wide x 30" Deep	C-CSRK3066C	2x	
11. Volker Cube 18" High x 18" Wide x 18" Deep	F-CUBE181818	2x	See Seating Price List for details.
12. Duplex Outlets - Line 1	E-MW8W4DO1	3x	
13. Duplex Outlets - Line 2	E-MW8W4DO2	3x	
14. Duplex Outlets - Line 4	E-MW8W4DO4	3x	
15. Electrical Jumpers 39" Long	E-HM8W4PJ30	2x	
16. Single Gang Plate Adapters	E-DJA	2x	
17. Side-Mounted Base Infeeds	E-UN8W4BIFS	1x	
18. Sliding Run-Off Tracks 60" Wide	C-CRRT60	2x	
19. Sliding Run-Off Tracks 42" Wide	C-CRRT42	1x	

Typical 13

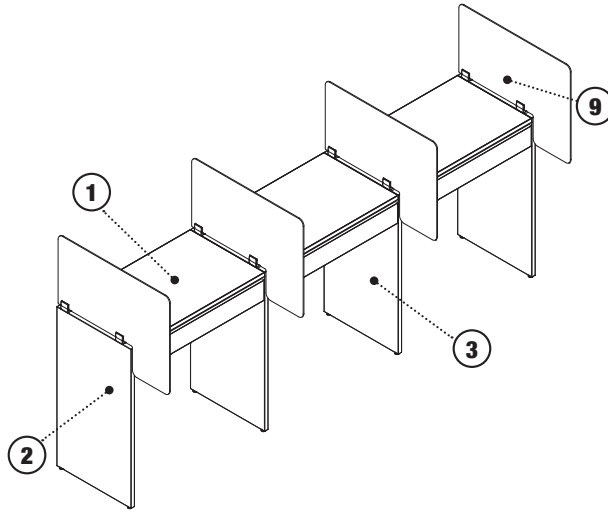

Description	Model Number	Quantity	Notes
1. Single Sided Powered Spine 42" Wide x 24" Deep	C-COMSP1-4224	3x	
2. Top Mount End Panels 24" Deep x 46" High	C-CEP2446	2x	
3. Shared Top Mount End Panels 24" Deep x 46" High	C-CEPTS2446	2x	
4. Duplex Outlets - Line 1	E-MW8W4DO1	3x	
5. USB Outlets - Line 2	E-UN8W4USB02	3x	
6. Duplex Outlets - Line 4	E-MW8W4DO4	3x	
7. Side-Mounted Base Infeeds	E-UN8W4BIFS	1x	
8. Electrical Jumpers 30" Long	E-UN8W4J30	2x	
9. Lexan 1/4" Territory Drop Surface Mount Clip Screen 20" High x 24" Wide	Y-1D3A1U2024B	4x	Coming soon.

Non-Powered Spines

NON-POWERED SPINE				NON-POWERED SPINE			
W	D	Model Number	List	W	D	Model Number	List
24	18	C-COMSNP-2418	1,725	60	18	C-COMSNP-6018	2,628
24	24	C-COMSNP-2424	1,793	60	24	C-COMSNP-6024	2,853
24	30	C-COMSNP-2430	1,978	60	30	C-COMSNP-6030	2,960
24	36	C-COMSNP-2436	2,046	60	36	C-COMSNP-6036	3,131
30	18	C-COMSNP-3018	1,838	66	18	C-COMSNP-6618	2,729
30	24	C-COMSNP-3024	1,922	66	24	C-COMSNP-6624	2,970
30	30	C-COMSNP-3030	2,124	66	30	C-COMSNP-6630	3,093
30	36	C-COMSNP-3036	2,207	66	36	C-COMSNP-6636	3,279
36	18	C-COMSNP-3618	1,929	72	18	C-COMSNP-7218	2,937
36	24	C-COMSNP-3624	2,034	72	24	C-COMSNP-7224	3,194
36	30	C-COMSNP-3630	2,250	72	30	C-COMSNP-7230	3,334
36	36	C-COMSNP-3636	2,355	72	36	C-COMSNP-7236	3,535
42	18	C-COMSNP-4218	2,031	78	18	C-COMSNP-7818	3,036
42	24	C-COMSNP-4224	2,150	78	24	C-COMSNP-7824	3,279
42	30	C-COMSNP-4230	2,421	84	18	C-COMSNP-8418	3,184
42	36	C-COMSNP-4236	2,503	84	24	C-COMSNP-8424	3,471
48	18	C-COMSNP-4818	2,291	90	18	C-COMSNP-9018	3,285
48	24	C-COMSNP-4824	2,482	90	24	C-COMSNP-9024	3,588
48	30	C-COMSNP-4830	2,672	96	18	C-COMSNP-9618	3,381
48	36	C-COMSNP-4836	2,812	96	24	C-COMSNP-9624	3,701
54	18	C-COMSNP-5418	2,509				
54	24	C-COMSNP-5424	2,716				
54	30	C-COMSNP-5430	2,808				
54	36	C-COMSNP-5436	2,961				

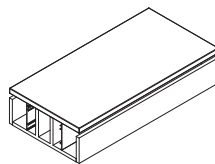

Specify	Notes
<ul style="list-style-type: none"> • Paint Selection for Internal Cover (Grade C Paint +10) • Laminate Choice 	<ul style="list-style-type: none"> • 8" high laminate cabinet with flip down doors on front and back. • Provides electrical and data distribution. • 1" gap above door maintained for egress of user power cords. • Internal centerline cavity for multi-circuit electrical cables. • External cavities on front and rear with metal cover provides lay-in data cable capabilities. • Non-powered does not include multi-circuit powerway.

Single Sided Powered Spines

SINGLE SIDED POWERED SPINE				SINGLE SIDED POWERED SPINE			
W	D	Model Number	List	W	D	Model Number	List
36	18	C-COMSP1-3618	2,511	66	18	C-COMSP1-6618	3,311
36	24	C-COMSP1-3624	2,811	66	24	C-COMSP1-6624	3,575
36	30	C-COMSP1-3630	2,873	66	30	C-COMSP1-6630	3,716
36	36	C-COMSP1-3636	2,981	66	36	C-COMSP1-6636	3,906
42	18	C-COMSP1-4218	2,613	72	18	C-COMSP1-7218	3,519
42	24	C-COMSP1-4224	2,926	72	24	C-COMSP1-7224	3,799
42	30	C-COMSP1-4230	3,044	72	30	C-COMSP1-7230	3,958
42	36	C-COMSP1-4236	3,129	72	36	C-COMSP1-7236	4,162
48	18	C-COMSP1-4818	2,873	78	18	C-COMSP1-7818	3,618
48	24	C-COMSP1-4824	3,087	78	24	C-COMSP1-7824	3,913
48	30	C-COMSP1-4830	3,296	84	18	C-COMSP1-8418	3,766
48	36	C-COMSP1-4836	3,438	84	24	C-COMSP1-8424	4,075
54	18	C-COMSP1-5418	3,091	90	18	C-COMSP1-9018	3,867
54	24	C-COMSP1-5424	3,320	90	24	C-COMSP1-9024	4,193
54	30	C-COMSP1-5430	3,432	96	18	C-COMSP1-9618	3,963
54	36	C-COMSP1-5436	3,587	96	24	C-COMSP1-9624	4,305
60	18	C-COMSP1-6018	3,210				
60	24	C-COMSP1-6024	3,458				
60	30	C-COMSP1-6030	3,583				
60	36	C-COMSP1-6036	3,758				

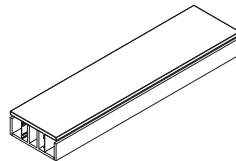

Specify	Notes
<ul style="list-style-type: none"> • Paint Selection (Grade C Paint +10) • Laminate Choice 	<ul style="list-style-type: none"> • 8" high laminate cabinet with flip down doors on front and back. • Provides electrical and data distribution. • 1" gap above door maintained for egress of user power cords. • Internal centerline cavity for multi-circuit electrical cables. • External cavities on front and rear with metal cover provides lay-in data cable capabilities. • Includes 8 wire 4 circuit powerway, centered left to right, facing one side only. • Accommodates up to 4 duplex outlets per powerway. • Specify up to 3 duplex outlets per powerway and one E-DJA Data Jack Adapter to accommodate data cable termination. • Includes 1 metal cover with 4 duplex Outlet holes and one non-powered (blank) cover. • Woodgrain laminate direction runs horizontally along the length of the spine and the drop-down panel.

Single Sided Chicago Powered Spines

SINGLE SIDED CHICAGO POWERED SPINE			
W	D	Model Number	List
36	18	C-COMSC1-3618	2,511
36	24	C-COMSC1-3624	2,811
36	30	C-COMSC1-3630	2,873
36	36	C-COMSC1-3636	2,981
42	18	C-COMSC1-4218	2,613
42	24	C-COMSC1-4224	2,926
42	30	C-COMSC1-4230	3,044
42	36	C-COMSC1-4236	3,129
48	18	C-COMSC1-4818	2,873
48	24	C-COMSC1-4824	3,087
48	30	C-COMSC1-4830	3,296
48	36	C-COMSC1-4836	3,438
54	18	C-COMSC1-5418	3,091
54	24	C-COMSC1-5424	3,320
54	30	C-COMSC1-5430	3,432
54	36	C-COMSC1-5436	3,587
60	18	C-COMSC1-6018	3,210
60	24	C-COMSC1-6024	3,458
60	30	C-COMSC1-6030	3,583
60	36	C-COMSC1-6036	3,758

SINGLE SIDED CHICAGO POWERED SPINE			
W	D	Model Number	List
66	18	C-COMSC1-6618	3,311
66	24	C-COMSC1-6624	3,575
66	30	C-COMSC1-6630	3,716
66	36	C-COMSC1-6636	3,906
72	18	C-COMSC1-7218	3,519
72	24	C-COMSC1-7224	3,799
72	30	C-COMSC1-7230	3,958
72	36	C-COMSC1-7236	4,162
78	18	C-COMSC1-7818	3,618
78	24	C-COMSC1-7824	3,913
84	18	C-COMSC1-8418	3,766
84	24	C-COMSC1-8424	4,075
90	18	C-COMSC1-9018	3,867
90	24	C-COMSC1-9024	4,193
96	18	C-COMSC1-9618	3,963
96	24	C-COMSC1-9624	4,305

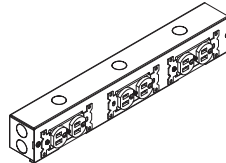
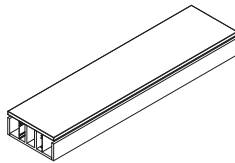

Junction Box

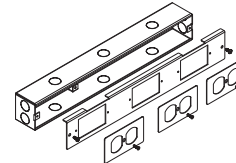

Junction Box

Specify

- Paint Selection (Grade C Paint +10)
- Laminate Choice

Notes

- 8" high laminate cabinet with flip down doors on front and back.
- Provides electrical and data distribution.
- 1" gap above door maintained for egress of user power cords.
- Internal centerline cavity for multi-circuit electrical cables.
- External cavities on front and rear with metal cover provides lay-in data cable capabilities.
- Includes (1) junction box with knockouts for electrical connectors, can be used with either 15 amp or 20 amp Standard NEMA single gang outlets. Boxes have standard 0.875" knockouts for electrical connectors.
- Outlets sold separately. Decorative outlets cannot be used.
- Woodgrain laminate direction runs horizontally along the length of the spine and the drop-down panel.

Double Sided Powered Spines

DOUBLE SIDED POWERED SPINE				DOUBLE SIDED POWERED SPINE			
W	D	Model Number	List	W	D	Model Number	List
36	18	C-COMSP2-3618	2,987	66	18	C-COMSP2-6618	3,784
36	24	C-COMSP2-3624	3,285	66	24	C-COMSP2-6624	4,049
36	30	C-COMSP2-3630	3,347	66	30	C-COMSP2-6630	4,191
36	36	C-COMSP2-3636	3,454	66	36	C-COMSP2-6636	4,381
42	18	C-COMSP2-4218	3,086	72	18	C-COMSP2-7218	3,992
42	24	C-COMSP2-4224	3,401	72	24	C-COMSP2-7224	4,271
42	30	C-COMSP2-4230	3,478	72	30	C-COMSP2-7230	4,432
42	36	C-COMSP2-4236	3,602	72	36	C-COMSP2-7236	4,637
48	18	C-COMSP2-4818	3,346	78	18	C-COMSP2-7818	4,094
48	24	C-COMSP2-4824	3,561	78	24	C-COMSP2-7824	4,390
48	30	C-COMSP2-4830	3,771	84	18	C-COMSP2-8418	4,237
48	36	C-COMSP2-4836	3,912	84	24	C-COMSP2-8424	4,549
54	18	C-COMSP2-5418	3,597	90	18	C-COMSP2-9018	4,337
54	24	C-COMSP2-5424	3,797	90	24	C-COMSP2-9024	4,668
54	30	C-COMSP2-5430	3,906	96	18	C-COMSP2-9618	4,437
54	36	C-COMSP2-5436	4,062	96	24	C-COMSP2-9624	4,779
60	18	C-COMSP2-6018	3,685				
60	24	C-COMSP2-6024	3,930				
60	30	C-COMSP2-6030	4,059				
60	36	C-COMSP2-6036	4,231				

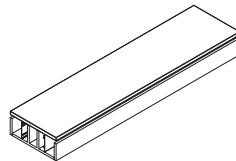

Specify	Notes
<ul style="list-style-type: none"> • Paint Selection (Grade C Paint +10) • Laminate Choice 	<ul style="list-style-type: none"> • 8" high laminate cabinet with flip down doors on front and back. • Provides electrical and data distribution. • 1" gap above door maintained for egress of user power cords. • Internal centerline cavity for multi-circuit electrical cables. • External cavities on front and rear with metal cover provides lay-in data cable capabilities. • Includes 8 wire 4 circuit powerway, centered left to right, facing both front and back. • Accommodates up to 4 duplex outlets per powerway (4 facing front, 4 facing back). • Specify up to 3 duplex outlets per powerway and one E-DJA Data Jack Adapter to accommodate data cable termination (3+1 facing front, 3+1 facing back) • Includes 2 metal covers with 4 duplex outlet holes. • Woodgrain laminate direction runs horizontally along the length of the spine and the drop-down panel.

Double Sided Chicago Powered Spines

DOUBLE SIDED CHICAGO POWERED SPINE			
W	D	Model Number	List
36	18	C-COMSC2-3618	2,987
36	24	C-COMSC2-3624	3,285
36	30	C-COMSC2-3630	3,347
36	36	C-COMSC2-3636	3,454
42	18	C-COMSC2-4218	3,086
42	24	C-COMSC2-4224	3,401
42	30	C-COMSC2-4230	3,478
42	36	C-COMSC2-4236	3,602
48	18	C-COMSC2-4818	3,346
48	24	C-COMSC2-4824	3,561
48	30	C-COMSC2-4830	3,771
48	36	C-COMSC2-4836	3,912
54	18	C-COMSC2-5418	3,597
54	24	C-COMSC2-5424	3,797
54	30	C-COMSC2-5430	3,906
54	36	C-COMSC2-5436	4,062
60	18	C-COMSC2-6018	3,685
60	24	C-COMSC2-6024	3,930
60	30	C-COMSC2-6030	4,059
60	36	C-COMSC2-6036	4,231

DOUBLE SIDED CHICAGO POWERED SPINE			
W	D	Model Number	List
66	18	C-COMSC2-6618	3,784
66	24	C-COMSC2-6624	4,049
66	30	C-COMSC2-6630	4,191
66	36	C-COMSC2-6636	4,381
72	18	C-COMSC2-7218	3,992
72	24	C-COMSC2-7224	4,271
72	30	C-COMSC2-7230	4,432
72	36	C-COMSC2-7236	4,637
78	18	C-COMSC2-7818	4,094
78	24	C-COMSC2-7824	4,390
84	18	C-COMSC2-8418	4,237
84	24	C-COMSC2-8424	4,549
90	18	C-COMSC2-9018	4,337
90	24	C-COMSC2-9024	4,668
96	18	C-COMSC2-9618	4,437
96	24	C-COMSC2-9624	4,779

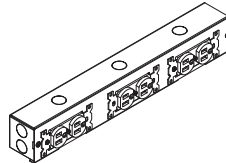
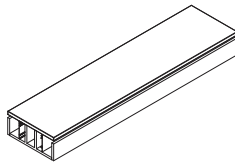

Junction Box

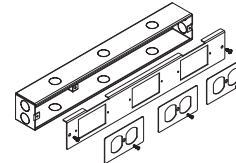

Junction Box

Specify

- Paint Selection (Grade C Paint +10)
- Laminate Choice

Notes

- 8" high laminate cabinet with flip down doors on front and back.
- Provides electrical and data distribution.
- 1" gap above door maintained for egress of user power cords.
- Internal centerline cavity for multi-circuit electrical cables.
- External cavities on front and rear with metal cover provides lay-in data cable capabilities.
- Includes (2) junction box with knockouts for electrical connectors, can be used with either 15 amp or 20 amp Standard NEMA single gang outlets. Boxes have standard 0.875" knockouts for electrical connectors.
- Outlets sold separately. Decorative outlets cannot be used.
- Woodgrain laminate direction runs horizontally along the length of the spine and the drop-down panel.

Top Mount End Panels and Shared Top Mount End Panels

TOP MOUNT END PANELS

D	H	Model Number	List
18	21	C-CEP1821	335
18	29	C-CEP1829	421
18	42	C-CEP1842	505
18	46	C-CEP1846	525
24	21	C-CEP2421	517
24	29	C-CEP2429	603
24	42	C-CEP2442	687
24	46	C-CEP2446	706
30	21	C-CEP3021	699
30	29	C-CEP3029	786
30	42	C-CEP3042	875
30	46	C-CEP3046	896
36	21	C-CEP3621	881
36	29	C-CEP3629	966
36	42	C-CEP3642	1,058
36	46	C-CEP3646	1,076



24D x 29H Shown

SHARED TOP MOUNT END PANELS

D	H	Model Number	List
18	21	C-CEPTS1821	335
18	29	C-CEPTS1829	421
18	42	C-CEPTS1842	505
18	46	C-CEPTS1846	525
24	21	C-CEPTS2421	517
24	29	C-CEPTS2429	603
24	42	C-CEPTS2442	687
24	46	C-CEPTS2446	706
30	21	C-CEPTS3021	699
30	29	C-CEPTS3029	786
30	42	C-CEPTS3042	875
30	46	C-CEPTS3046	896
36	21	C-CEPTS3621	881
36	29	C-CEPTS3629	966
36	42	C-CEPTS3642	1,058
36	46	C-CEPTS3646	1,076

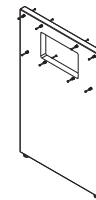

24D x 29H Shown

Specify

Notes

- Laminite Selection
- Top Mount End Panel supports one end of spine at top of end panel and overlays the end of the spine.
- Top Mount End Panels add 1 1/8" to end of spine.
- Specify the end panel that matches spine depth.

Specify

Notes

- Laminite Selection
- Shared Top Mount End Panel supports the end of 2 spines at top of end panel and adds 1 1/8" to length of spine.
- Specify the end panel that matches spine depth.
- Shared Top Mount End Panels have center cutouts to accommodate running electrical and data cables.

Top Mount Shared End Panels

TOP MOUNT SHARED END PANELS				
D	Overall H	Lower Spine Mount H	Model Number	List
18	29	21	C-CEPTS182129	1,559
18	42	21	C-CEPTS182142	1,822
18	42	29	C-CEPTS182942	1,822
18	46	21	C-CEPTS182146	1,978
18	46	29	C-CEPTS182946	1,978
24	29	21	C-CEPTS242129	1,872
24	42	21	C-CEPTS242142	2,140
24	42	29	C-CEPTS242942	2,140
24	46	21	C-CEPTS242146	2,295
24	46	29	C-CEPTS242946	2,295

TOP MOUNT SHARED END PANELS				
D	Overall H	Lower Spine Mount H	Model Number	List
30	29	21	C-CEPTS302129	2,182
30	42	21	C-CEPTS302142	2,463
30	42	29	C-CEPTS302942	2,463
30	46	21	C-CEPTS302146	2,619
30	46	29	C-CEPTS302946	2,619
36	29	21	C-CEPTS362129	2,494
36	42	21	C-CEPTS362142	2,781
36	42	29	C-CEPTS362942	2,781
36	46	21	C-CEPTS362146	2,935
36	46	29	C-CEPTS362946	2,935

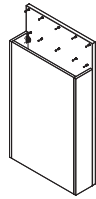

Front View
46H x 24D with 21H Lower Mount Height Shown

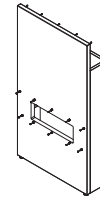

Back View
46H x 24D with 21H Lower Mount Height Shown

Specify

- Laminate Selection

Notes

- Top Mount Shared End Panels supports the ends of 2 spines at various offset heights with one spine mounted at top and one spine mounted lower.
- Top Mount Shared End Panels adds 1 1/8" to length of spine overall.
- Top Mount Shared End Panels DO NOT accommodate electrical and data cable transition without field modifications.
- Specify the end panel that matches the spine depth.
- There is no option to transition power between the heights of 42" high and 46" high.

Mid Mount End Panels

MID MOUNT END PANELS					MID MOUNT END PANELS				
D	Overall H	Spine Mount H	Model Number	List	D	Overall H	Spine Mount H	Model Number	List
18	42	12	C-CEP184221	505	30	42	21	C-CEP304221	786
18	42	29	C-CEP184229	505	30	42	29	C-CEP304229	786
18	46	21	C-CEP184621	525	30	46	21	C-CEP304621	896
18	46	29	C-CEP184629	525	30	46	29	C-CEP304629	896
18	50	21	C-CEP185021	545	30	50	21	C-CEP305021	916
18	50	29	C-CEP185029	545	30	50	29	C-CEP305029	916
18	50	42	C-CEP185042	545	30	50	42	C-CEP305042	916
18	58	21	C-CEP185821	584	30	58	21	C-CEP305821	968
18	58	29	C-CEP185829	584	30	58	29	C-CEP305829	968
18	58	42	C-CEP185842	584	30	58	42	C-CEP305842	968
18	66	21	C-CEP186621	624	30	66	21	C-CEP306621	1,020
18	66	29	C-CEP186629	624	30	66	29	C-CEP306629	1,020
18	66	42	C-CEP186642	624	30	66	42	C-CEP306642	1,020
24	42	21	C-CEP244221	687	36	42	21	C-CEP364221	966
24	42	29	C-CEP244229	687	36	42	29	C-CEP364229	966
24	46	21	C-CEP244621	706	36	46	21	C-CEP364621	1,076
24	46	29	C-CEP244629	706	36	46	29	C-CEP364629	1,076
24	50	21	C-CEP245021	727	36	50	21	C-CEP365021	1,098
24	50	29	C-CEP245029	727	36	50	29	C-CEP365029	1,098
24	50	42	C-CEP245042	727	36	50	42	C-CEP365042	1,098
24	58	21	C-CEP245821	778	36	58	21	C-CEP365821	1,163
24	58	29	C-CEP245829	778	36	58	29	C-CEP365829	1,163
24	58	42	C-CEP245842	778	36	58	42	C-CEP365842	1,163
24	66	21	C-CEP246621	831	36	66	21	C-CEP366621	1,228
24	66	29	C-CEP246629	831	36	66	29	C-CEP366629	1,228
24	66	42	C-CEP246642	831	36	66	42	C-CEP366642	1,228



42H x 18D x 29H Mount Height Shown

Specify	Notes
• Laminate Selection	<ul style="list-style-type: none"> • Mid Mount End Panel supports one end of spine at various height with a section of end panel above spine mounting height to act as a finished end for storage or screens or to create a space for adjacent gallery panels and rolling whiteboards. • End panel overlays end of spine and adds 1 1/8" to spine. • Specify the end panel that matches the spine depth.

Shared Mid Mount End Panels

SHARED MID MOUNT END PANELS				
D	Overall H	Spine Mount H	Model Number	List
18	29	21	C-CEPMS182921	421
18	42	21	C-CEPMS184221	505
18	42	29	C-CEPMS184229	505
18	46	21	C-CEPMS184621	525
18	46	29	C-CEPMS184629	525
18	50	21	C-CEPMS185021	545
18	50	29	C-CEPMS185029	545
18	50	42	C-CEPMS185042	545
18	58	21	C-CEPMS185821	584
18	58	29	C-CEPMS185829	584
18	58	42	C-CEPMS185842	584
18	58	46	C-CEPMS185846	584
18	66	21	C-CEPMS186621	624
18	66	29	C-CEPMS186629	624
18	66	42	C-CEPMS186642	624
18	66	46	C-CEPMS186646	624

SHARED MID MOUNT END PANELS				
D	Overall H	Spine Mount H	Model Number	List
24	29	21	C-CEPMS242921	603
24	42	21	C-CEPMS244221	687
24	42	29	C-CEPMS244229	687
24	46	21	C-CEPMS244621	706
24	46	29	C-CEPMS244629	706
24	50	21	C-CEPMS245021	727
24	50	29	C-CEPMS245029	727
24	50	42	C-CEPMS245042	727
24	58	21	C-CEPMS245821	778
24	58	29	C-CEPMS245829	778
24	58	42	C-CEPMS245842	778
24	58	46	C-CEPMS245846	778
24	66	21	C-CEPMS246621	831
24	66	29	C-CEPMS246629	831
24	66	42	C-CEPMS246642	831
24	66	46	C-CEPMS246646	831

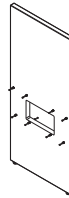

Specify

- Laminate Selection

Notes

- Shared Mid Mount End Panel supports the ends of 2 spines at various matching heights with a section of panel above spine mounting height to act as a finished end for storage or screens or to create a space for adjacent gallery panels and rolling whiteboards.
- Shared Mid Mount End Panel adds 1 1/8" to length of spine overall.
- Shared Mid Mount End Panels have center cutouts to accommodate running electrical and data cables.
- Specify the end panel that matches the spine depth.

Shared Mid Mount End Panels

SHARED MID MOUNT END PANELS				
D	Overall H	Spine Mount H	Model Number	List
30	29	21	C-CEPMS302921	786
30	42	21	C-CEPMS304221	875
30	42	29	C-CEPMS304229	875
30	46	21	C-CEPMS304621	896
30	46	29	C-CEPMS304629	896
30	50	21	C-CEPMS305021	916
30	50	29	C-CEPMS305029	916
30	50	42	C-CEPMS305042	916
30	58	21	C-CEPMS305821	968
30	58	29	C-CEPMS305829	968
30	58	42	C-CEPMS305842	968
30	58	46	C-CEPMS305846	968
30	66	21	C-CEPMS306621	1,020
30	66	29	C-CEPMS306629	1,020
30	66	42	C-CEPMS306642	1,020
30	66	46	C-CEPMS306646	1,020

SHARED MID MOUNT END PANELS				
D	Overall H	Spine Mount H	Model Number	List
36	29	21	C-CEPMS362921	966
36	42	21	C-CEPMS364221	1,058
36	42	29	C-CEPMS364229	1,058
36	46	21	C-CEPMS364621	1,076
36	46	29	C-CEPMS364629	1,076
36	50	21	C-CEPMS365021	1,098
36	50	29	C-CEPMS365029	1,098
36	50	42	C-CEPMS365042	1,098
36	58	21	C-CEPMS365821	1,163
36	58	29	C-CEPMS365829	1,163
36	58	42	C-CEPMS365842	1,163
36	58	46	C-CEPMS365846	1,163
36	66	21	C-CEPMS366621	1,228
36	66	29	C-CEPMS366629	1,228
36	66	42	C-CEPMS366642	1,228
36	66	46	C-CEPMS366646	1,228

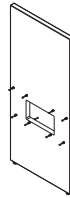

Specify

- Laminate Selection

Notes

- Shared Mid Mount End Panel supports the ends of 2 spines at various matching heights with a section of panel above spine mounting height to act as a finished end for storage or screens or to create a space for adjacent gallery panels and rolling whiteboards.
- Shared Mid Mount End Panel adds 1 1/8" to length of spine overall.
- Shared Mid Mount End Panels have center cutouts to accommodate running electrical and data cables.
- Specify the end panel that matches the spine depth.

Offset Shared End Panels

OFFSET SHARED END PANELS				
D	Overall H	Lower Spine Mount H	Model Number	List
18	29	21	C-CEPS182921	421
18	42	21	C-CEPS184221	505
18	42	29	C-CEPS184229	505
18	46	21	C-CEPS184621	525
18	46	29	C-CEPS184629	525
24	29	21	C-CEPS242921	603
24	42	21	C-CEPS244221	687
24	42	29	C-CEPS244229	687
24	46	21	C-CEPS244621	706
24	46	29	C-CEPS244629	706

OFFSET SHARED END PANELS				
D	Overall H	Lower Spine Mount H	Model Number	List
30	29	21	C-CEPS302921	786
30	42	21	C-CEPS304221	875
30	42	29	C-CEPS304229	875
30	46	21	C-CEPS304621	896
30	46	29	C-CEPS304629	896
36	29	21	C-CEPS362921	966
36	42	21	C-CEPS364221	1,058
36	42	29	C-CEPS364229	1,058
36	46	21	C-CEPS364621	1,076
36	46	29	C-CEPS364629	1,076

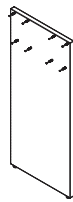

Front View
42H x 18D with 21H Lower
Mount Height Shown

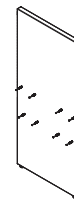

Back View
42H x 18D with 21H Lower
Mount Height Shown

Specify

- Laminate Selection

Notes

- Offset Shared End Panel supports the ends of 2 spines at various offset heights with one spine mounted at top and one spine mounted lower.
- Offset Shared End Panel adds 1 1/8" to length of spine overall.
- Offset Shared End Panel DO NOT accommodate electrical and data cable transition without field modifications.
- Specify the end panel that matches the spine depth.

Shared Mid Mount Offset End Panels

SHARED MID MOUNT OFFSET END PANELS					
D	Overall H	Upper Spine H	Lower Spine H	Model Number	List
18	46	29	21	C-EPMS18462921	1,663
18	46	42	21	C-EPMS18464221	1,843
18	46	42	29	C-EPMS18464229	1,843
24	46	29	21	C-EPMS24462921	1,975
24	46	42	21	C-EPMS24464221	2,159
24	46	42	29	C-EPMS24464229	2,159
30	46	29	21	C-EPMS30462921	2,294
30	46	42	21	C-EPMS30464221	2,483
30	46	42	29	C-EPMS30464229	2,483
36	46	29	21	C-EPMS36462921	2,604
36	46	42	21	C-EPMS36464221	2,800
36	46	42	29	C-EPMS36464229	2,800

SHARED MID MOUNT OFFSET END PANELS					
D	Overall H	Upper Height	Lower Height	Model Number	List
18	50	29	21	C-EPMS18502921	1,683
18	50	42	21	C-EPMS18504221	1,863
18	50	46	21	C-EPMS18504621	1,998
18	50	42	29	C-EPMS18504229	1,863
18	50	46	29	C-EPMS18504629	1,998
24	50	29	21	C-EPMS24502921	1,996
24	50	42	21	C-EPMS24504221	2,180
24	50	46	21	C-EPMS24504621	2,316
24	50	42	29	C-EPMS24504229	2,180
24	50	46	29	C-EPMS24504629	2,316
30	50	29	21	C-EPMS30502921	2,313
30	50	42	21	C-EPMS30504221	2,503
30	50	46	21	C-EPMS30504621	2,639
30	50	42	29	C-EPMS30504229	2,503
30	50	46	29	C-EPMS30504629	2,639
36	50	29	21	C-EPMS36502921	2,627
36	50	42	21	C-EPMS36504221	2,821
36	50	46	21	C-EPMS36504621	2,956
36	50	42	29	C-EPMS36504229	2,821
36	50	46	29	C-EPMS36504629	2,956

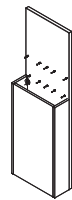

Front View

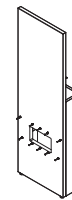

Back View

Specify

- Laminate Selection

Notes

- Shared Mid Mount Offset End Panels support the ends of 2 spines at varied heights with a section of panel above spine mounting height to act as a finished end for storage or screens or to create a space for adjacent gallery panels and rolling whiteboards.
- Adds 1 1/8" to length of spine overall.
- Center cutouts accommodate running electrical and data cables.
- Specify the Shared Mid Mount Offset End Panel that matches the spine depth.
- Transitions require longer jumpers, see below:
 - 21H spine to 29H spine, add 12" to jumper length
 - 21H spine to 42H spine, add 24" to jumper length
 - 21H spine to 46H spine, add 30" to jumper length
 - 29H spine to 42H spine, add 18" to jumper length
 - 29H spine to 46H spine, add 18" to jumper length

Shared Mid Mount Offset End Panels

SHARED MID MOUNT OFFSET END PANELS					
D	Overall H	Upper Spine H	Lower Spine H	Model Number	List
18	58	29	21	C-EPMS18582921	1,722
18	58	42	21	C-EPMS18584221	1,902
18	58	46	21	C-EPMS18584621	2,037
18	58	42	29	C-EPMS18584229	1,902
18	58	46	29	C-EPMS18584629	2,037
24	58	29	21	C-EPMS24582921	2,047
24	58	42	21	C-EPMS24584221	2,232
24	58	46	21	C-EPMS24584621	2,368
24	58	42	29	C-EPMS24584229	2,232
24	58	46	29	C-EPMS24584629	2,368
30	58	29	21	C-EPMS30582921	2,367
30	58	42	21	C-EPMS30584221	2,557
30	58	46	21	C-EPMS30584621	2,692
30	58	42	29	C-EPMS30584229	2,557
30	58	46	29	C-EPMS30584629	2,692
36	58	29	21	C-EPMS36582921	2,692
36	58	42	21	C-EPMS36584221	2,886
36	58	46	21	C-EPMS36584621	3,022
36	58	42	29	C-EPMS36584229	2,886
36	58	46	29	C-EPMS36584629	3,022

SHARED MID MOUNT OFFSET END PANELS					
D	Overall H	Upper Spine H	Lower Spine H	Model Number	List
18	66	29	21	C-EPMS18662921	1,761
18	66	42	21	C-EPMS18664221	1,940
18	66	46	21	C-EPMS18664621	2,076
18	66	42	29	C-EPMS18664229	1,940
18	66	46	29	C-EPMS18664629	2,076
24	66	29	21	C-EPMS24662921	2,100
24	66	42	21	C-EPMS24664221	2,285
24	66	46	21	C-EPMS24664621	2,421
24	66	42	29	C-EPMS24664229	2,285
24	66	46	29	C-EPMS24664629	2,421
30	66	29	21	C-EPMS30662921	2,419
30	66	42	21	C-EPMS30664221	2,608
30	66	46	21	C-EPMS30664621	2,744
30	66	42	29	C-EPMS30664229	2,608
30	66	46	29	C-EPMS30664629	2,744
36	66	29	21	C-EPMS36662921	2,757
36	66	42	21	C-EPMS36664221	2,952
36	66	46	21	C-EPMS36664621	3,087
36	66	42	29	C-EPMS36664229	2,952
36	66	46	29	C-EPMS36664629	3,087

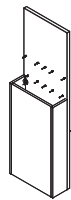

Front View

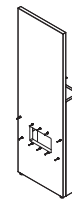

Back View

Specify

- Laminate Selection

Notes

- Shared Mid Mount Offset End Panels support the ends of 2 spines at varied heights with a section of panel above spine mounting height to act as a finished end for storage or screens or to create a space for adjacent gallery panels and rolling whiteboards.
- Adds 1 1/8" to length of spine overall.
- Center cutouts accommodate running electrical and data cables.
- Specify the Shared Mid Mount Offset End Panel that matches the spine depth.
- Transitions require longer jumpers, see below:
 - 21H spine to 29H spine, add 12" to jumper length
 - 21H spine to 42H spine, add 24" to jumper length
 - 21H spine to 46H spine, add 30" to jumper length
 - 29H spine to 42H spine, add 18" to jumper length
 - 29H spine to 46H spine, add 18" to jumper length

MID SUPPORTS

D	H	For Use With	Model Number	List
18	13	21 High	C-CMSP1821	295
18	21	29 High	C-CMSP1829	335
24	21	21 High	C-CMSP2421	477
24	29	29 High	C-CMSP2429	517
30	13	21 High	C-CMSP3021	659
30	21	29 High	C-CMSP3029	699
36	13	21 High	C-CMSP3621	841
36	21	29 High	C-CMSP3629	881

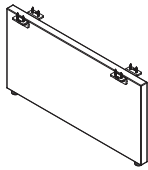

Specify

Notes

• Laminate Selection

- Mid Supports are used to support 2 adjacent spines at 21” or 29” high.
- Mid Supports sit “under” spines and do not add dimension to spine run.

Infeed Base Supports

INFEED BASE SUPPORT					
D	W	H	For Use With	Model Number	List
18	6	13	21 High	C-CIBS180613	1,106
18	6	21	29 High	C-CIBS180621	1,139
18	6	33	42 High	C-CIBS180633	1,269
18	6	37	46 High	C-CIBS180637	1,400
18	12	13	21 High	C-CIBS181213	1,211
18	12	21	29 High	C-CIBS181221	1,315
18	12	33	42 High	C-CIBS181233	1,446
18	12	37	46 High	C-CIBS181237	1,576
24	6	13	21 High	C-CIBS240613	1,237
24	6	21	29 High	C-CIBS240621	1,269
24	6	33	42 High	C-CIBS240633	1,400
24	6	37	46 High	C-CIBS240637	1,531
24	12	13	21 High	C-CIBS241213	1,342
24	12	21	29 High	C-CIBS241221	1,444
24	12	33	42 High	C-CIBS241233	1,575
24	12	37	46 High	C-CIBS241237	1,706

INFEED BASE SUPPORT					
D	W	H	For Use With	Model Number	List
30	6	13	21 High	C-CIBS300613	1,366
30	6	21	29 High	C-CIBS300621	1,399
30	6	33	42 High	C-CIBS300633	1,530
30	6	37	46 High	C-CIBS300637	1,660
30	12	13	21 High	C-CIBS301213	1,471
30	12	21	29 High	C-CIBS301221	1,575
30	12	33	42 High	C-CIBS301233	1,706
30	12	37	46 High	C-CIBS301237	1,836
36	6	13	21 High	C-CIBS360613	1,496
36	6	21	29 High	C-CIBS360621	1,530
36	6	33	42 High	C-CIBS360633	1,660
36	6	37	46 High	C-CIBS360637	1,791
36	12	13	21 High	C-CIBS361213	1,602
36	12	21	29 High	C-CIBS361221	1,705
36	12	33	42 High	C-CIBS361233	1,835
36	12	37	46 High	C-CIBS361237	1,966

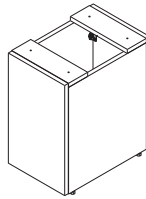

Specify

- Laminate Selection

Notes

- Infeed Base supports may be used to support spines as well as allow for transition of electrical and data cables from a floor core to spine.
- Infeed Base Supports have removable front and back panels and an open bottom to accommodate access to floor cores.
- Order support that matches spine depth.
- Supports are 6" or 12" wide and should be planned with adjacent storage elements appropriately.

Fixed Run-Offs

**FIXED RUN-OFFS
(2MM EDGE WITH TAPERED LEGS)**

H	W	D	Model Number	List
29	36	24	X-DROR2436T	1,635
29	42	24	X-DROR2442T	1,680
29	48	24	X-DROR2448T	1,723
29	54	24	X-DROR2454T	1,767
29	60	24	X-DROR2460T	1,812
29	66	24	X-DROR2466T	1,857
29	72	24	X-DROR2472T	1,901
29	78	24	X-DROR2478T	1,943
29	84	24	X-DROR2484T	1,987
29	36	30	X-DROR3036T	1,700
29	42	30	X-DROR3042T	1,744
29	48	30	X-DROR3048T	1,788
29	54	30	X-DROR3054T	1,833
29	60	30	X-DROR3060T	1,876
29	66	30	X-DROR3066T	1,923
29	72	30	X-DROR3072T	1,965
29	78	30	X-DROR3078T	2,008
29	84	30	X-DROR3084T	2,052

**FIXED RUN-OFFS
(KNIFE EDGE WITH TAPERED LEGS)**

H	W	D	Model Number	List
29	36	24	X-DROK2436T	3,136
29	42	24	X-DROK2442T	3,179
29	48	24	X-DROK2448T	3,223
29	54	24	X-DROK2454T	3,267
29	60	24	X-DROK2460T	3,287
29	66	24	X-DROK2466T	3,344
29	72	24	X-DROK2472T	3,381
29	78	24	X-DROK2478T	3,462
29	84	24	X-DROK2484T	3,481
29	36	30	X-DROK3036T	3,202
29	42	30	X-DROK3042T	3,245
29	48	30	X-DROK3048T	3,288
29	54	30	X-DROK3054T	3,333
29	60	30	X-DROK3060T	3,353
29	66	30	X-DROK3066T	3,409
29	72	30	X-DROK3072T	3,447
29	78	30	X-DROK3078T	3,527
29	84	30	X-DROK3084T	3,547

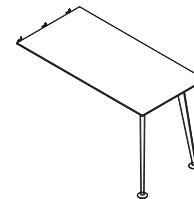
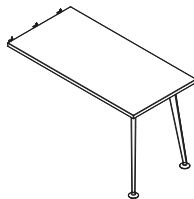

Specify

Notes

- Laminate Selection for Worksurface
- Color Selection for Leg
- Color Selection for Edge

- Fixed Run-off tables are designed for long side to mount perpendicular to 29" high spines in a fixed manner.
- Fixed Run-off table mounting does not impede flip door or electrical access.

Fixed Run-Offs

**FIXED RUN-OFFS
(2MM EDGE WITH O-LEGS)**

D	W	Model Number	List
24	36	X-DROR2436O	1,879
24	42	X-DROR2442O	1,932
24	48	X-DROR2448O	1,982
24	54	X-DROR2454O	2,033
24	60	X-DROR2460O	2,083
24	66	X-DROR2466O	2,137
24	72	X-DROR2472O	2,185
24	78	X-DROR2478O	2,235
24	84	X-DROR2484O	2,285
30	36	X-DROR3036O	1,954
30	42	X-DROR3042O	2,005
30	48	X-DROR3048O	2,056
30	54	X-DROR3054O	2,108
30	60	X-DROR3060O	2,157
30	66	X-DROR3066O	2,211
30	72	X-DROR3072O	2,259
30	78	X-DROR3078O	2,308
30	84	X-DROR3084O	2,360
36	72	X-DROR3672O	2,402
36	78	X-DROR3678O	2,456

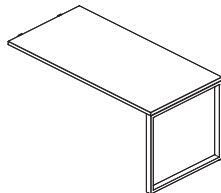

Specify	Notes
<ul style="list-style-type: none"> • Laminate Selection for Worksurface • Edgeband Selection • Paint Selection for Leg (+25 for Grade C) 	<ul style="list-style-type: none"> • O-Legs are constructed from 1" x 2" painted steel. • Legs have 1 1/2" leveling glides. • Includes attachment hardware. Units 48" wide and over also include a worksurface u-channel. • Fixed Run-off tables are designed for long side to mount perpendicular to 29" high spines in a fixed manner. • Fixed Run-off table mounting does not impede flip door or electrical access.

Fixed Round Corner Run-Offs

**FIXED ROUND CORNER RUN-OFFS
(2MM EDGE WITH TAPERED LEGS)**

H	W	D	Model Number	List
29	36	24	X-DORR2436T	1,786
29	42	24	X-DORR2442T	1,831
29	48	24	X-DORR2448T	1,874
29	54	24	X-DORR2454T	1,919
29	60	24	X-DORR2460T	1,963
29	66	24	X-DORR2466T	2,008
29	72	24	X-DORR2472T	2,052
29	78	24	X-DORR2478T	2,095
29	84	24	X-DORR2484T	2,138
29	36	30	X-DORR3036T	1,852
29	42	30	X-DORR3042T	1,895
29	48	30	X-DORR3048T	1,939
29	54	30	X-DORR3054T	1,984
29	60	30	X-DORR3060T	2,028
29	66	30	X-DORR3066T	2,074
29	72	30	X-DORR3072T	2,116
29	78	30	X-DORR3078T	2,159
29	84	30	X-DORR3084T	2,204

**FIXED ROUND CORNER RUN-OFFS
(KNIFE EDGE WITH TAPERED LEGS)**

H	W	D	Model Number	List
29	36	24	X-DOKR2436T	3,136
29	42	24	X-DOKR2442T	3,179
29	48	24	X-DOKR2448T	3,223
29	54	24	X-DOKR2454T	3,267
29	60	24	X-DOKR2460T	3,287
29	66	24	X-DOKR2466T	3,344
29	72	24	X-DOKR2472T	3,381
29	78	24	X-DOKR2478T	3,462
29	84	24	X-DOKR2484T	3,481
29	36	30	X-DOKR3036T	3,202
29	42	30	X-DOKR3042T	3,245
29	48	30	X-DOKR3048T	3,288
29	54	30	X-DOKR3054T	3,333
29	60	30	X-DOKR3060T	3,353
29	66	30	X-DOKR3066T	3,409
29	72	30	X-DOKR3072T	3,447
29	78	30	X-DOKR3078T	3,527
29	84	30	X-DOKR3084T	3,547

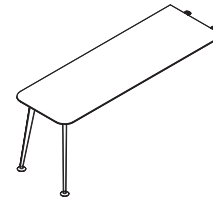
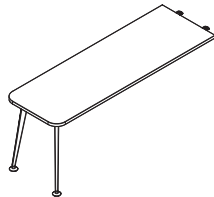

Specify

Notes

- Laminate Selection for Worksurface
- Color Selection for Leg
- Color Selection for Edge

- Fixed Run-off tables are designed for long side to mount perpendicular to 29" high spines in a fixed manner.
- Fixed Run-off table mounting does not impede flip door or electrical access.

Sliding Run-Offs

SLIDING RUN-OFFS (2MM EDGE WITH TAPERED LEGS)						
H	W	D	With Glides		With Caster	
			Model Number	List	Model Number	List
29	36	24	C-CSRR2436G	1,700	C-CSRR2436C	1,758
29	42	24	C-CSRR2442G	1,744	C-CSRR2442C	1,803
29	48	24	C-CSRR2448G	1,788	C-CSRR2448C	1,846
29	54	24	C-CSRR2454G	1,833	C-CSRR2454C	1,889
29	60	24	C-CSRR2460G	1,876	C-CSRR2460C	1,936
29	66	24	C-CSRR2466G	1,923	C-CSRR2466C	1,982
29	72	24	C-CSRR2472G	1,965	C-CSRR2472C	2,023
29	78	24	C-CSRR2478G	2,008	C-CSRR2478C	2,067
29	84	24	C-CSRR2484G	2,052	C-CSRR2484C	2,110
29	36	30	C-CSRR3036G	1,765	C-CSRR3036C	1,824
29	42	30	C-CSRR3042G	1,808	C-CSRR3042C	1,868
29	48	30	C-CSRR3048G	1,853	C-CSRR3048C	1,912
29	54	30	C-CSRR3054G	1,898	C-CSRR3054C	1,955
29	60	30	C-CSRR3060G	1,942	C-CSRR3060C	2,000
29	66	30	C-CSRR3066G	1,988	C-CSRR3066C	2,047
29	72	30	C-CSRR3072G	2,030	C-CSRR3072C	2,088
29	78	30	C-CSRR3078G	2,073	C-CSRR3078C	2,131
29	84	30	C-CSRR3084G	2,116	C-CSRR3084C	2,176

SLIDING RUN-OFFS (KNIFE EDGE WITH TAPERED LEGS)						
H	W	D	With Glides		With Caster	
			Model Number	List	Model Number	List
29	36	24	C-CSRK2436G	3,202	C-CSRK2436C	3,258
29	42	24	C-CSRK2442G	3,245	C-CSRK2442C	3,303
29	48	24	C-CSRK2448G	3,288	C-CSRK2448C	3,347
29	54	24	C-CSRK2454G	3,333	C-CSRK2454C	3,391
29	60	24	C-CSRK2460G	3,353	C-CSRK2460C	3,410
29	66	24	C-CSRK2466G	3,409	C-CSRK2466C	3,468
29	72	24	C-CSRK2472G	3,447	C-CSRK2472C	3,506
29	78	24	C-CSRK2478G	3,527	C-CSRK2478C	3,585
29	84	24	C-CSRK2484G	3,547	C-CSRK2484C	3,607
29	36	30	C-CSRK3036G	3,265	C-CSRK3036C	3,324
29	42	30	C-CSRK3042G	3,310	C-CSRK3042C	3,368
29	48	30	C-CSRK3048G	3,354	C-CSRK3048C	3,411
29	54	30	C-CSRK3054G	3,398	C-CSRK3054C	3,455
29	60	30	C-CSRK3060G	3,417	C-CSRK3060C	3,476
29	66	30	C-CSRK3066G	3,475	C-CSRK3066C	3,534
29	72	30	C-CSRK3072G	3,512	C-CSRK3072C	3,571
29	78	30	C-CSRK3078G	3,591	C-CSRK3078C	3,650
29	84	30	C-CSRK3084G	3,612	C-CSRK3084C	3,670

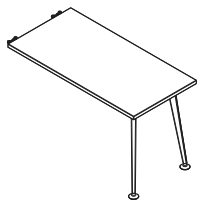

On Glides

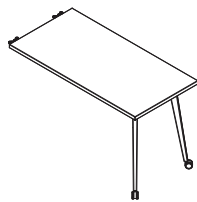

On Casters

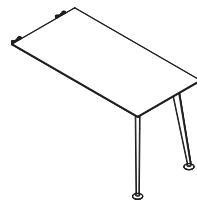

On Glides

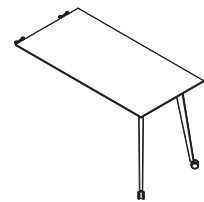

On Casters

Specify

- Laminate Selection for Worksurface
- Color Selection for Leg
- Color Selection for Edge

Notes

- Sliding Run-off tables are designed for the long side to mount perpendicular to 29 high spines that have Sliding Run-off Tracks which can be ORDERED SEPARATELY for any spine length.
- Sliding Run-offs can be ordered with casters for tables often being moved, or with glides for tables that are seldom moved.
- Sliding Run-offs with glides must be lifted slightly at end with legs to slide.
- Sliding Run-off table mounting DOES NOT impede flip door or electrical access.
- Sliding Run-off tables can slide between tracks on adjacent spines.

**SLIDING RUN-OFFS
(2MM EDGE WITH O-LEGS)**

D	W	Model Number	List
24	36	C-CSRRO2436G	1,954
24	42	C-CSRRO2442G	2,005
24	48	C-CSRRO2448G	2,056
24	54	C-CSRRO2454G	2,108
24	60	C-CSRRO2460G	2,158
24	66	C-CSRRO2466G	2,211
24	72	C-CSRRO2472G	2,259
24	78	C-CSRRO2478G	2,310
24	84	C-CSRRO2484G	2,360
30	36	C-CSRRO3036G	2,030
30	42	C-CSRRO3042G	2,079
30	48	C-CSRRO3048G	2,130
30	54	C-CSRRO3054G	2,182
30	60	C-CSRRO3060G	2,234
30	66	C-CSRRO3066G	2,287
30	72	C-CSRRO3072G	2,333
30	78	C-CSRRO3078G	2,382
30	84	C-CSRRO3084G	2,434

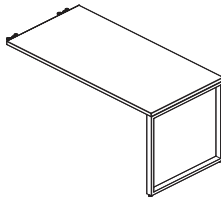

Specify	Notes
<ul style="list-style-type: none"> • Laminate Selection for Worksurface • Edgeband Selection • Paint Selection for Leg (+25 for Grade C) 	<ul style="list-style-type: none"> • Sliding Run-off tables are designed for the long side to mount perpendicular to 29 high spines that have Sliding Run-off Tracks which can be ORDERED SEPARATELY for any spine length. • O-Legs are constructed from 1" x 2" painted steel. • Available on 1 1/2" leveling glides only. • Includes attachment hardware. Units 48" wide and over also include a worksurface u-channel. • Sliding Run-offs with glides must be lifted slightly at end with legs to slide. • Sliding Run-off table mounting DOES NOT impede flip door or electrical access. • Sliding Run-off tables can slide between tracks on adjacent spines.

Sliding Round Corner Run-Offs

SLIDING ROUND CORNER RUN-OFFS (2MM EDGE WITH TAPERED LEGS)						
H	W	D	With Glides		With Caster	
			Model Number	List	Model Number	List
29	36	24	C-CSRRR2436G	1,852	C-CSRRR2436C	1,758
29	42	24	C-CSRRR2442G	1,895	C-CSRRR2442C	1,803
29	48	24	C-CSRRR2448G	1,939	C-CSRRR2448C	1,846
29	54	24	C-CSRRR2454G	1,984	C-CSRRR2454C	1,889
29	60	24	C-CSRRR2460G	2,028	C-CSRRR2460C	1,936
29	66	24	C-CSRRR2466G	2,074	C-CSRRR2466C	1,982
29	72	24	C-CSRRR2472G	2,116	C-CSRRR2472C	2,023
29	78	24	C-CSRRR2478G	2,159	C-CSRRR2478C	2,067
29	84	24	C-CSRRR2484G	2,204	C-CSRRR2484C	2,110
29	36	30	C-CSRRR3036G	1,916	C-CSRRR3036C	1,824
29	42	30	C-CSRRR3042G	1,960	C-CSRRR3042C	1,868
29	48	30	C-CSRRR3048G	2,004	C-CSRRR3048C	1,912
29	54	30	C-CSRRR3054G	2,049	C-CSRRR3054C	1,955
29	60	30	C-CSRRR3060G	2,094	C-CSRRR3060C	2,000
29	66	30	C-CSRRR3066G	2,139	C-CSRRR3066C	2,047
29	72	30	C-CSRRR3072G	2,181	C-CSRRR3072C	2,088
29	78	30	C-CSRRR3078G	2,224	C-CSRRR3078C	2,131
29	84	30	C-CSRRR3084G	2,267	C-CSRRR3084C	2,176

SLIDING ROUND CORNER RUN-OFFS (KNIFE EDGE WITH TAPERED LEGS)						
H	W	D	With Glides		With Caster	
			Model Number	List	Model Number	List
29	36	24	C-CSRRK2436G	3,353	C-CSRRK2436C	3,258
29	42	24	C-CSRRK2442G	3,396	C-CSRRK2442C	3,303
29	48	24	C-CSRRK2448G	3,439	C-CSRRK2448C	3,347
29	54	24	C-CSRRK2454G	3,485	C-CSRRK2454C	3,391
29	60	24	C-CSRRK2460G	3,504	C-CSRRK2460C	3,410
29	66	24	C-CSRRK2466G	3,560	C-CSRRK2466C	3,468
29	72	24	C-CSRRK2472G	3,598	C-CSRRK2472C	3,506
29	78	24	C-CSRRK2478G	3,678	C-CSRRK2478C	3,585
29	84	24	C-CSRRK2484G	3,698	C-CSRRK2484C	3,607
29	36	30	C-CSRRK3036G	3,417	C-CSRRK3036C	3,324
29	42	30	C-CSRRK3042G	3,461	C-CSRRK3042C	3,368
29	48	30	C-CSRRK3048G	3,505	C-CSRRK3048C	3,411
29	54	30	C-CSRRK3054G	3,549	C-CSRRK3054C	3,455
29	60	30	C-CSRRK3060G	3,568	C-CSRRK3060C	3,476
29	66	30	C-CSRRK3066G	3,626	C-CSRRK3066C	3,534
29	72	30	C-CSRRK3072G	3,663	C-CSRRK3072C	3,571
29	78	30	C-CSRRK3078G	3,743	C-CSRRK3078C	3,650
29	84	30	C-CSRRK3084G	3,763	C-CSRRK3084C	3,670

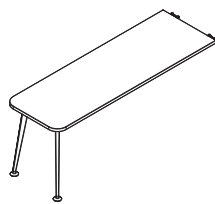

On Glides

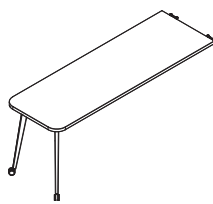

On Casters

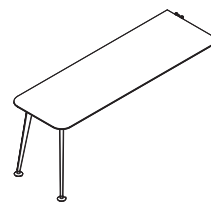

On Glides

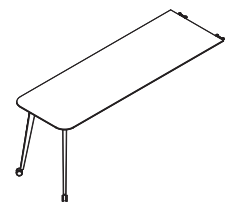

On Casters

Specify

- Laminate Selection for Worksurface
- Color Selection for Leg
- Color Selection for Edge

Notes

- Sliding Run-off tables are designed for the long side to mount perpendicular to 29 high spines that have Sliding Run-off Tracks which can be ORDERED SEPARATELY for any spine length.
- Sliding Run-offs can be ordered with casters for tables often being moved, or with glides for tables that are seldom moved.
- Sliding Run-offs with glides must be lifted slightly at end with legs to slide.
- Sliding Run-off table mounting DOES NOT impede flip door or electrical access.
- Sliding Run-off tables can slide between tracks on adjacent spines.

SLIDING RUN-OFF TRACKS

W	Model Number	List
24	C-CRRT24	175
30	C-CRRT30	198
36	C-CRRT36	219
42	C-CRRT42	241
48	C-CRRT48	261
54	C-CRRT54	283
60	C-CRRT60	306
66	C-CRRT66	326
72	C-CRRT72	349
78	C-CRRT78	371
84	C-CRRT84	391
90	C-CRRT90	414
96	C-CRRT96	436

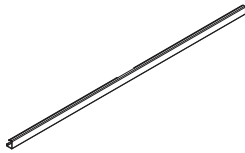

Specify	Notes
<ul style="list-style-type: none"> • Paint Selection 	<ul style="list-style-type: none"> • Sliding Run-off Tracks can be mounted to front and back of any spine to accommodate sliding run-off surfaces. • Each track is sold separately for one side of a spine. • Order track that corresponds to the complete length of the spine. • Tracks are visible behind power cord access gap and can be paint the color of choosing.

Fixed Spine Surfaces

**FIXED SPINE SURFACES
(2MM EDGE WITH TAPERED LEGS)**

H	W	D	Model Number	List
29	36	18	X-DROR1836TS	1,635
29	42	18	X-DROR1842TS	1,680
29	48	18	X-DROR1848TS	1,723
29	54	18	X-DROR1854TS	1,767
29	60	18	X-DROR1860TS	1,812
29	66	18	X-DROR1866TS	1,857
29	72	18	X-DROR1872TS	1,901
29	78	18	X-DROR1878TS	1,943
29	84	18	X-DROR1884TS	1,987
29	36	24	X-DROR2436TS	1,635
29	42	24	X-DROR2442TS	1,680
29	48	24	X-DROR2448TS	1,723
29	54	24	X-DROR2454TS	1,767
29	60	24	X-DROR2460TS	1,812
29	66	24	X-DROR2466TS	1,857
29	72	24	X-DROR2472TS	1,901
29	78	24	X-DROR2478TS	1,943
29	84	24	X-DROR2484TS	1,987
29	36	30	X-DROR3036TS	1,700
29	42	30	X-DROR3042TS	1,744
29	48	30	X-DROR3048TS	1,788
29	54	30	X-DROR3054TS	1,833
29	60	30	X-DROR3060TS	1,876
29	66	30	X-DROR3066TS	1,923
29	72	30	X-DROR3072TS	1,965
29	78	30	X-DROR3078TS	2,008
29	84	30	X-DROR3084TS	2,052

**FIXED SPINE SURFACES
(KNIFE EDGE WITH TAPERED LEGS)**

H	W	D	Model Number	List
29	36	18	X-DROK1836TS	3,136
29	42	18	X-DROK1842TS	3,179
29	48	18	X-DROK1848TS	3,223
29	54	18	X-DROK1854TS	3,267
29	60	18	X-DROK1860TS	3,287
29	66	18	X-DROK1866TS	3,344
29	72	18	X-DROK1872TS	3,381
29	78	18	X-DROK1878TS	3,462
29	84	18	X-DROK1884TS	3,481
29	36	24	X-DROK2436TS	3,136
29	42	24	X-DROK2442TS	3,179
29	48	24	X-DROK2448TS	3,223
29	54	24	X-DROK2454TS	3,267
29	60	24	X-DROK2460TS	3,287
29	66	24	X-DROK2466TS	3,344
29	72	24	X-DROK2472TS	3,381
29	78	24	X-DROK2478TS	3,462
29	84	24	X-DROK2484TS	3,481
29	36	30	X-DROK3036TS	3,136
29	42	30	X-DROK3042TS	3,179
29	48	30	X-DROK3048TS	3,223
29	54	30	X-DROK3054TS	3,267
29	60	30	X-DROK3060TS	3,287
29	66	30	X-DROK3066TS	3,344
29	72	30	X-DROK3072TS	3,381
29	78	30	X-DROK3078TS	3,462
29	84	30	X-DROK3084TS	3,481

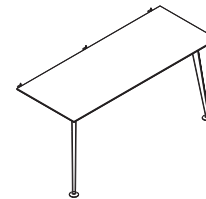
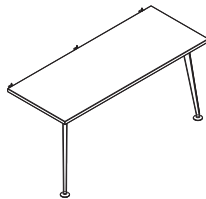

Specify

Notes

- Laminate Selection for Worksurface
- Color Selection for Leg
- Color Selection for Edge
- Grommet Option and Color

- Fixed Spine Surfaces are designed for long side to mount PARALLEL to 29 high spines in a fixed manner.
- Fixed Spine Surface mounting does not impede flip door or electrical access.
- Fixed Spine Surfaces may be ordered with grommets on long sides.

Cantilevered Spine Surfaces

CANTILEVERED SPINE SURFACES (2MM EDGE)

H	W	D	Model Number	List
29	36	18	C-CCSSR1836	1,635
29	42	18	C-CCSSR1842	1,680
29	48	18	C-CCSSR1848	1,723
29	54	18	C-CCSSR1854	1,767
29	60	18	C-CCSSR1860	1,812
29	66	18	C-CCSSR1866	1,857
29	72	18	C-CCSSR1872	1,901

CANTILEVERED SPINE SURFACES (KNIFE EDGE)

H	W	D	Model Number	List
29	36	18	C-CCSSK1836	3,136
29	42	18	C-CCSSK1842	3,179
29	48	18	C-CCSSK1848	3,223
29	54	18	C-CCSSK1854	3,267
29	60	18	C-CCSSK1860	3,287
29	66	18	C-CCSSK1866	3,344
29	72	18	C-CCSSK1872	3,381

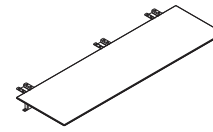
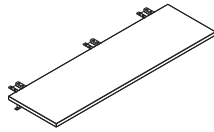

Specify

Notes

- Laminate Selection for Worksurface
- Color Selection for Leg
- Color Selection for Edge
- Color Selection for Cantilevers
- Grommet Option and Color

- Cantilevered Spine Surfaces mount to spine cabinets supported by storage elements. See guidelines in product details.
- Cantilevered Spine Surfaces DO NOT impede flip door access.
- Cantilevered Spine Surfaces can be ordered with Grommets on long side.

Stack-On Desks

STACK-ON DESKS					
H	W	D	Left Modesty	Right Modesty	List
			Model Number	Model Number	
29	42	24	X-SODL284224	X-SODR284224	1,087
29	48	24	X-SODL284824	X-SODR284824	1,123
29	54	24	X-SODL285424	X-SODR285424	1,141
29	60	24	X-SODL286024	X-SODR286024	1,192
29	66	24	X-SODL286624	X-SODR286624	1,232
29	72	24	X-SODL287224	X-SODR287224	1,266
29	78	24	X-SODL287824	X-SODR287824	1,301
29	84	24	X-SODL288424	X-SODR288424	1,338
29	42	30	X-SODL284230	X-SODR284230	1,172
29	48	30	X-SODL284830	X-SODR284830	1,213
29	54	30	X-SODL285430	X-SODR285430	1,254
29	60	30	X-SODL286030	X-SODR286030	1,294
29	66	30	X-SODL286630	X-SODR286630	1,338
29	72	30	X-SODL287230	X-SODR287230	1,382
29	78	30	X-SODL287830	X-SODR287830	1,422
29	84	30	X-SODL288430	X-SODR288430	1,464

CENTERED MODESTY STACK-ON DESKS					
H	W	D	Model Number	List	
29	42	36	X-SODM284236	1,224	
29	48	36	X-SODM284836	1,308	
29	54	36	X-SODM285436	1,354	
29	60	36	X-SODM286036	1,399	
29	66	36	X-SODM286636	1,448	
29	72	36	X-SODM287236	1,494	
29	78	36	X-SODM287836	1,542	
29	84	36	X-SODM288436	1,587	

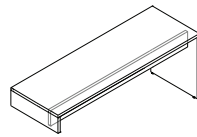

Left Modesty

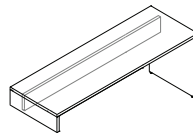

Right Modesty

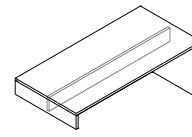

Center Modesty

Specify

- Laminate Selection for Worksurface
- Laminate Selection for Case

Notes

- Stack on Desks are designed to be stacked ON 21" HIGH SPINES ONLY to serve as run-off desks perpendicular to spines.
- Available in Left, Right or with Centered modesty on deeper sizes.
- Modesty on handed units are recessed 4 inches leaving knee space of 18 inches on 24d and 24 inches on 30d.

SPINE HUTCH F (18" DEEP)					SPINE HUTCH F (24" DEEP)				
H	W	D	Model Number	List	H	W	D	Model Number	List
12	24	18	C-CSH122418F	1,152	12	24	24	C-CSH122424F	1,250
12	30	18	C-CSH123018F	1,219	12	30	24	C-CSH123024F	1,331
12	36	18	C-CSH123618F	1,462	12	36	24	C-CSH123624F	1,611
12	42	18	C-CSH124218F	1,525	12	42	24	C-CSH124224F	1,690
12	48	18	C-CSH124818F	1,597	12	48	24	C-CSH124824F	1,777
12	54	18	C-CSH125418F	1,662	12	54	24	C-CSH125424F	1,857
12	60	18	C-CSH126018F	1,728	12	60	24	C-CSH126024F	1,942
12	66	18	C-CSH126618F	1,914	12	66	24	C-CSH126624F	2,141
12	72	18	C-CSH127218F	1,977	12	72	24	C-CSH127224F	2,221
16	24	18	C-CSH162418F	1,204	16	24	24	C-CSH162424F	1,313
16	30	18	C-CSH163018F	1,277	16	30	24	C-CSH163024F	1,399
16	36	18	C-CSH163618F	1,541	16	36	24	C-CSH163624F	1,704
16	42	18	C-CSH164218F	1,610	16	42	24	C-CSH164224F	1,789
16	48	18	C-CSH164818F	1,686	16	48	24	C-CSH164824F	1,883
16	54	18	C-CSH165418F	1,755	16	54	24	C-CSH165424F	1,967
16	60	18	C-CSH166018F	1,829	16	60	24	C-CSH166024F	2,058
16	66	18	C-CSH166618F	2,018	16	66	24	C-CSH166624F	2,262
16	72	18	C-CSH167218F	2,087	16	72	24	C-CSH167224F	2,347
20	24	18	C-CSH202418F	1,260	20	24	24	C-CSH202424F	1,381
20	30	18	C-CSH203018F	1,335	20	30	24	C-CSH203024F	1,473
20	36	18	C-CSH203618F	1,624	20	36	24	C-CSH203624F	1,804
20	42	18	C-CSH204218F	1,696	20	42	24	C-CSH204224F	1,893
20	48	18	C-CSH204818F	1,781	20	48	24	C-CSH204824F	1,994
20	54	18	C-CSH205418F	1,854	20	54	24	C-CSH205424F	2,084
20	60	18	C-CSH206018F	1,935	20	60	24	C-CSH206024F	2,178
20	66	18	C-CSH206618F	2,129	20	66	24	C-CSH206624F	2,389
20	72	18	C-CSH207218F	2,204	20	72	24	C-CSH207224F	2,478

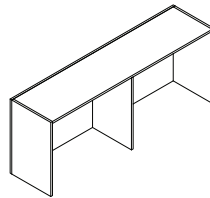

Specify

- Laminate Selection

Notes

- Provides storage and space division facing one side only.
- 24 - 30" wide units have no divider, 36 - 72" wide units have a divider.
- Full finished back.
- Unit provided with rubber high friction strips for retention.

Spine Hutch F

SPINE HUTCH F (18" DEEP)					SPINE HUTCH F (24" DEEP)				
H	W	D	Model Number	List	H	W	D	Model Number	List
28	24	18	C-CSH282418F	1,398	28	24	24	C-CSH282424F	1,448
28	30	18	C-CSH283018F	1,708	28	30	24	C-CSH283024F	1,545
28	36	18	C-CSH283618F	1,786	28	36	24	C-CSH283624F	1,905
28	42	18	C-CSH284218F	1,876	28	42	24	C-CSH284224F	1,997
28	48	18	C-CSH284818F	1,953	28	48	24	C-CSH284824F	2,104
28	54	18	C-CSH285418F	2,038	28	54	24	C-CSH285424F	2,199
28	60	18	C-CSH286018F	2,239	28	60	24	C-CSH286024F	2,299
28	66	18	C-CSH286618F	2,319	28	66	24	C-CSH286624F	2,515
28	72	18	C-CSH287218F	1,460	28	72	24	C-CSH287224F	2,610
36	24	18	C-CSH362418F	1,793	36	24	24	C-CSH362424F	1,515
36	30	18	C-CSH363018F	1,874	36	30	24	C-CSH363024F	1,617
36	36	18	C-CSH363618F	1,973	36	36	24	C-CSH363624F	2,004
36	42	18	C-CSH364218F	2,052	36	42	24	C-CSH364224F	2,101
36	48	18	C-CSH364818F	2,144	36	48	24	C-CSH364824F	2,214
36	54	18	C-CSH365418F	2,349	36	54	24	C-CSH365424F	2,315
36	60	18	C-CSH366018F	2,434	36	60	24	C-CSH366024F	2,421
36	66	18	C-CSH366618F	1,460	36	66	24	C-CSH366624F	2,641
36	72	18	C-CSH367218F	1,793	36	72	24	C-CSH367224F	2,740

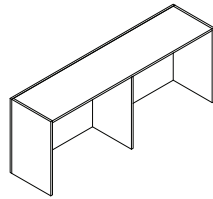

Specify

- Laminate Selection

Notes

- Provides storage and space division facing one side only.
- 24 - 30" wide units have no divider, 36 - 72" wide units have a divider.
- Full finished back.
- Unit provided with rubber high friction strips for retention.

SPINE HUTCH G (18" DEEP)

SPINE HUTCH G (24" DEEP)

H	W	D	Model Number	List
20	24	18	C-CSH202418G	1,625
20	30	18	C-CSH203018G	1,733
20	36	18	C-CSH203618G	1,995
20	42	18	C-CSH204218G	2,087
20	48	18	C-CSH204818G	2,195
20	54	18	C-CSH205418G	2,410
20	60	18	C-CSH206018G	2,513
20	66	18	C-CSH206618G	2,621
20	72	18	C-CSH207218G	2,837
20	78	18	C-CSH207818G	2,940
20	84	18	C-CSH208418G	3,042

H	W	D	Model Number	List
20	24	24	C-CSH202424G	1,787
20	30	24	C-CSH203024G	1,917
20	36	24	C-CSH203624G	2,216
20	42	24	C-CSH204224G	2,332
20	48	24	C-CSH204824G	2,466
20	54	24	C-CSH205424G	2,708
20	60	24	C-CSH206024G	2,835
20	66	24	C-CSH206624G	2,966
20	72	24	C-CSH207224G	3,210
20	78	24	C-CSH207824G	3,338
20	84	24	C-CSH208424G	3,466

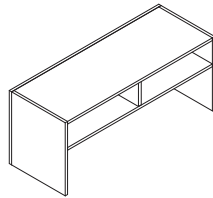

Specify

Notes

- Laminate Selection

- Provides storage and space division facing one side only.
- Full finished back.
- 20" high unit has 8" high cubby above.
- 24 - 30" wide units have no divider, 36 - 72" wide units have a divider.
- Unit provided with rubber high friction strips for retention.

Spine Hutch G

SPINE HUTCH G WITH 8" HIGH CUBBY SHELF (18" DEEP)

H	W	D	Cubby H	Model Number	List
28	24	18	8	C-CSH282418G8	1,738
28	30	18	8	C-CSH283018G8	1,857
28	36	18	8	C-CSH283618G8	2,126
28	42	18	8	C-CSH284218G8	2,229
28	48	18	8	C-CSH284818G8	2,346
28	54	18	8	C-CSH285418G8	2,573
28	60	18	8	C-CSH286018G8	2,688
28	66	18	8	C-CSH286618G8	2,804
28	72	18	8	C-CSH287218G8	3,032
28	78	18	8	C-CSH287818G8	3,144
28	84	18	8	C-CSH288418G8	3,258
36	24	18	8	C-CSH362418G8	1,795
36	30	18	8	C-CSH363018G8	1,919
36	36	18	8	C-CSH363618G8	2,216
36	42	18	8	C-CSH364218G8	2,325
36	48	18	8	C-CSH364818G8	2,447
36	54	18	8	C-CSH365418G8	2,676
36	60	18	8	C-CSH366018G8	2,794
36	66	18	8	C-CSH366618G8	2,915
36	72	18	8	C-CSH367218G8	3,145
36	78	18	8	C-CSH367818G8	3,263
36	84	18	8	C-CSH368418G8	3,380

SPINE HUTCH G WITH 8" HIGH CUBBY SHELF (24" DEEP)

H	W	D	Cubby H	Model Number	List
28	24	24	8	C-CSH282424G8	1,917
28	30	24	8	C-CSH283024G8	2,060
28	36	24	8	C-CSH283624G8	2,368
28	42	24	8	C-CSH284224G8	2,496
28	48	24	8	C-CSH284824G8	2,640
28	54	24	8	C-CSH285424G8	2,893
28	60	24	8	C-CSH286024G8	3,031
28	66	24	8	C-CSH286624G8	3,174
28	72	24	8	C-CSH287224G8	3,427
28	78	24	8	C-CSH287824G8	3,566
28	84	24	8	C-CSH288424G8	3,703
28	24	24	8	C-CSH362424G8	2,000
28	30	24	8	C-CSH363024G8	2,146
28	36	24	8	C-CSH363624G8	2,490
28	42	24	8	C-CSH364224G8	2,624
28	48	24	8	C-CSH364824G8	2,772
28	54	24	8	C-CSH365424G8	3,022
28	60	24	8	C-CSH366024G8	3,165
28	66	24	8	C-CSH366624G8	3,313
28	72	24	8	C-CSH367224G8	3,567
28	78	24	8	C-CSH367824G8	3,706
28	84	24	8	C-CSH368424G8	3,851

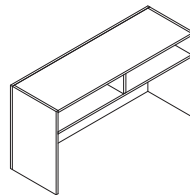

Specify

- Laminate Selection

Notes

- Provides storage and space division facing one side only.
- Full finished back.
- 28" high unit has 8" or 16" high cubby above.
- Unit provided with rubber high friction strips for retention.

SPINE HUTCH G WITH 16" HIGH CUBBY SHELF (18" DEEP)

SPINE HUTCH G WITH 16" HIGH CUBBY SHELF (24" DEEP)

H	W	D	Cubby H	Model Number	List
28	24	18	16	C-CSH282418G16	1,740
28	30	18	16	C-CSH283018G16	1,857
28	36	18	16	C-CSH283618G16	2,165
28	42	18	16	C-CSH284218G16	2,268
28	48	18	16	C-CSH284818G16	2,386
28	54	18	16	C-CSH285418G16	2,615
28	60	18	16	C-CSH286018G16	2,729
28	66	18	16	C-CSH286618G16	2,845
28	72	18	16	C-CSH287218G16	3,074
28	78	18	16	C-CSH287818G16	3,186
28	84	18	16	C-CSH288418G16	3,300
36	24	18	16	C-CSH362418G16	1,889
36	30	18	16	C-CSH363018G16	2,020
36	36	18	16	C-CSH363618G16	2,332
36	42	18	16	C-CSH364218G16	2,447
36	48	18	16	C-CSH364818G16	2,575
36	54	18	16	C-CSH365418G16	2,817
36	60	18	16	C-CSH366018G16	2,942
36	66	18	16	C-CSH366618G16	3,071
36	72	18	16	C-CSH367218G16	3,311
36	78	18	16	C-CSH367818G16	3,436
36	84	18	16	C-CSH368418G16	3,559

H	W	D	Cubby H	Model Number	List
28	24	24	16	C-CSH282424G16	1,924
28	30	24	16	C-CSH283024G16	2,068
28	36	24	16	C-CSH283624G16	2,420
28	42	24	16	C-CSH284224G16	2,549
28	48	24	16	C-CSH284824G16	2,692
28	54	24	16	C-CSH285424G16	2,946
28	60	24	16	C-CSH286024G16	3,084
28	66	24	16	C-CSH286624G16	3,226
28	72	24	16	C-CSH287224G16	3,481
28	78	24	16	C-CSH287824G16	3,620
28	84	24	16	C-CSH288424G16	3,760
36	24	24	16	C-CSH362424G16	2,105
36	30	24	16	C-CSH363024G16	2,260
36	36	24	16	C-CSH363624G16	2,622
36	42	24	16	C-CSH364224G16	2,763
36	48	24	16	C-CSH364824G16	2,918
36	54	24	16	C-CSH365424G16	3,182
36	60	24	16	C-CSH366024G16	3,333
36	66	24	16	C-CSH366624G16	3,487
36	72	24	16	C-CSH367224G16	3,755
36	78	24	16	C-CSH367824G16	3,901
36	84	24	16	C-CSH368424G16	4,054

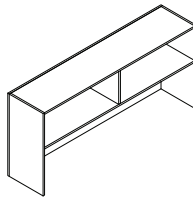

Specify

Notes

• Laminate Selection

- Provides storage and space division facing one side only.
- Full finished back.
- 28" high unit has 8" or 16" high cubby above.
- 24 - 30" wide units have no divider, 36 - 72" wide units have a divider.
- Unit provided with rubber high friction strips for retention.

Spine Hutch J

SPINE HUTCH J (18" DEEP)						
				Cabinet Left	Cabinet Right	
H	W	D	Shelf H	Model Number	Model Number	List
20	60	18	8	C-CSH206018JL	C-CSH206018J	3,046
20	66	18	8	C-CSH206618JL	C-CSH206618J	3,112
20	72	18	8	C-CSH207218JL	C-CSH207218J	3,183
20	78	18	8	C-CSH207818JL	C-CSH207818J	3,289
20	84	18	8	C-CSH208418JL	C-CSH208418J	3,359
28	60	18	8	C-CSH286018JL	C-CSH286018J	3,340
28	66	18	8	C-CSH286618JL	C-CSH286618J	3,417
28	72	18	8	C-CSH287218JL	C-CSH287218J	3,499
28	78	18	8	C-CSH287818JL	C-CSH287818J	3,628
28	84	18	8	C-CSH288418JL	C-CSH288418J	3,708
36	60	18	8	C-CSH36601808JL	C-CSH36601808J	3,573
36	66	18	8	C-CSH36661808JL	C-CSH36661808J	3,660
36	72	18	8	C-CSH36721808JL	C-CSH36721808J	3,750
36	78	18	8	C-CSH36781808JL	C-CSH36781808J	3,899
36	84	18	8	C-CSH36841808JL	C-CSH36841808J	3,988
36	60	18	16	C-CSH366018JL	C-CSH366018J	3,634
36	66	18	16	C-CSH366618JL	C-CSH366618J	3,722
36	72	18	16	C-CSH367218JL	C-CSH367218J	3,813
36	78	18	16	C-CSH367818JL	C-CSH367818J	3,965
36	84	18	16	C-CSH368418JL	C-CSH368418J	4,056

SPINE HUTCH J (24" DEEP)						
				Cabinet Left	Cabinet Right	
H	W	D	Shelf H	Model Number	Model Number	List
20	60	24	8	C-CSH206024JL	C-CSH206024J	3,289
20	66	24	8	C-CSH206624JL	C-CSH206624J	3,371
20	72	24	8	C-CSH207224JL	C-CSH207224J	3,456
20	78	24	8	C-CSH207824JL	C-CSH207824J	3,580
20	84	24	8	C-CSH208424JL	C-CSH208424J	3,666
28	60	24	8	C-CSH286024JL	C-CSH286024J	3,615
28	66	24	8	C-CSH286624JL	C-CSH286624J	3,707
28	72	24	8	C-CSH287224JL	C-CSH287224J	3,803
28	78	24	8	C-CSH287824JL	C-CSH287824J	3,948
28	84	24	8	C-CSH288424JL	C-CSH288424J	4,044
36	60	18	8	C-CSH36602408JL	C-CSH36602408J	3,873
36	66	18	8	C-CSH36662408JL	C-CSH36662408J	3,974
36	72	18	8	C-CSH36722408JL	C-CSH36722408J	4,081
36	78	18	8	C-CSH36782408JL	C-CSH36782408J	4,244
36	84	18	8	C-CSH36842408JL	C-CSH36842408J	4,351
36	60	24	16	C-CSH366024JL	C-CSH366024J	3,940
36	66	24	16	C-CSH366624JL	C-CSH366624J	4,042
36	72	24	16	C-CSH367224JL	C-CSH367224J	4,151
36	78	24	16	C-CSH367824JL	C-CSH367824J	4,316
36	84	24	16	C-CSH368424JL	C-CSH368424J	4,424

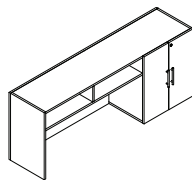

20 - 28" High Cabinet Right

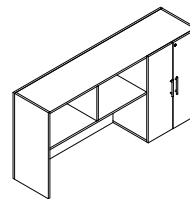

36" High Cabinet Right

Specify

- Laminate Selection for Doors
- Laminate Selection for Case
- Choice of Handle

Notes

- Provides storage and space division facing one side only.
- Full finished back.
- 20" and 28" high unit has 8" high cubby above. 36" high unit has a 16" high cubby above.
- 60" - 72" wide units have 24" wide lockable storage cabinet with 1 adjustable shelf. 78" and 84" wide units have a 31 3/8" wide lockable storage cabinet with 1 adjustable shelf.
- Cabinets do not have shelves.
- Unit provided with rubber high friction strips for retention.

SPINE CABINET N (14" DEEP)

H	W	D	Model Number	List
16	24	14	C-SOCD162414	1,617
16	30	14	C-SOCD163014	1,700
16	36	14	C-SOCD163614	1,914
16	42	14	C-SOCD164214	1,988
16	48	14	C-SOCD164814	2,069
16	54	14	C-SOCD165414	2,230
16	60	14	C-SOCD166014	2,308
16	66	14	C-SOCD166614	2,391
16	72	14	C-SOCD167214	2,549
20	24	14	C-SOCD202414	1,887
20	30	14	C-SOCD203014	1,983
20	36	14	C-SOCD203614	2,234
20	42	14	C-SOCD204214	2,318
20	48	14	C-SOCD204814	2,413
20	54	14	C-SOCD205414	2,600
20	60	14	C-SOCD206014	2,692
20	66	14	C-SOCD206614	2,787
20	72	14	C-SOCD207214	2,974

SPINE CABINET N (14" DEEP)

H	W	D	Model Number	List
28	24	14	C-SOCD282414	2,200
28	30	14	C-SOCD283014	2,313
28	36	14	C-SOCD283614	2,604
28	42	14	C-SOCD284214	2,704
28	48	14	C-SOCD284814	2,814
28	54	14	C-SOCD285414	3,033
28	60	14	C-SOCD286014	3,141
28	66	14	C-SOCD286614	3,250
28	72	14	C-SOCD287214	3,468
36	24	14	C-SOCD362414	2,554
36	30	14	C-SOCD363014	2,684
36	36	14	C-SOCD363614	3,022
36	42	14	C-SOCD364214	3,137
36	48	14	C-SOCD364814	3,266
36	54	14	C-SOCD365414	3,519
36	60	14	C-SOCD366014	3,643
36	66	14	C-SOCD366614	3,773
36	72	14	C-SOCD367214	4,025

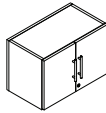

16" High, 24 - 48" Widths

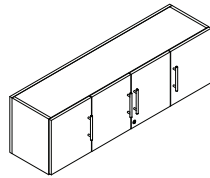

16" High, 54 - 72" Widths

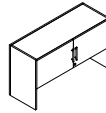

20 - 36" High, 24 - 48" Widths

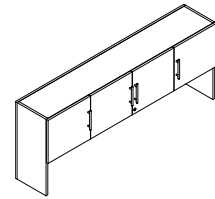

20 - 36" High, 54 - 72" Widths

Specify

- Laminate Selection for Doors
- Laminate Selection for Case
- Choice of Handle

Notes

- Compatible with Hutch A tackboards.
- Cabinets do not have shelves.
- 24 - 48" wide units feature two doors, units 54" wide and above feature four doors.

Spine Cabinet N

SPINE CABINET N (18" DEEP)

H	W	D	Model Number	List
16	24	18	C-SOCD162418	1,704
16	30	18	C-SOCD163018	1,789
16	36	18	C-SOCD163618	2,016
16	42	18	C-SOCD164218	2,091
16	48	18	C-SOCD164818	2,178
16	54	18	C-SOCD165418	2,347
16	60	18	C-SOCD166018	2,429
16	66	18	C-SOCD166618	2,515
16	72	18	C-SOCD167218	2,683
20	24	18	C-SOCD202418	1,987
20	30	18	C-SOCD203018	2,088
20	36	18	C-SOCD203618	2,351
20	42	18	C-SOCD204218	2,440
20	48	18	C-SOCD204818	2,541
20	54	18	C-SOCD205418	2,736
20	60	18	C-SOCD206018	2,834
20	66	18	C-SOCD206618	2,934
20	72	18	C-SOCD207218	3,129

SPINE CABINET N (18" DEEP)

H	W	D	Model Number	List
28	24	18	C-SOCD282418	2,317
28	30	18	C-SOCD283018	2,436
28	36	18	C-SOCD283618	2,742
28	42	18	C-SOCD284218	2,845
28	48	18	C-SOCD284818	2,963
28	54	18	C-SOCD285418	3,193
28	60	18	C-SOCD286018	3,305
28	66	18	C-SOCD286618	3,422
28	72	18	C-SOCD287218	3,651
36	24	18	C-SOCD362418	2,682
36	30	18	C-SOCD363018	2,819
36	36	18	C-SOCD363618	3,174
36	42	18	C-SOCD364218	3,294
36	48	18	C-SOCD364818	3,429
36	54	18	C-SOCD365418	3,696
36	60	18	C-SOCD366018	3,827
36	66	18	C-SOCD366618	3,962
36	72	18	C-SOCD367218	4,227

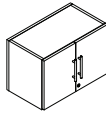

16" High, 24 - 48" Widths

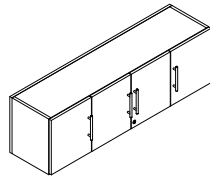

16" High, 54 - 72" Widths

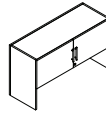

20 - 36" High, 24 - 48" Widths

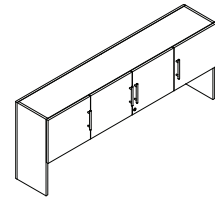

20 - 36" High, 54 - 72" Widths

Specify

- Laminate Selection for Doors
- Laminate Selection for Case
- Choice of Handle

Notes

- Compatible with Hutch A tackboards.
- Cabinets do not have shelves.
- 24 - 48" wide units feature two doors, units 54" wide and above feature four doors.

SPINE CABINET N (24" DEEP)

H	W	D	Model Number	List
16	24	24	C-SOCD162424	1,793
16	30	24	C-SOCD163024	1,884
16	36	24	C-SOCD163624	2,121
16	42	24	C-SOCD164224	2,202
16	48	24	C-SOCD164824	2,292
16	54	24	C-SOCD165424	2,470
16	60	24	C-SOCD166024	2,558
16	66	24	C-SOCD166624	2,649
16	72	24	C-SOCD167224	2,825
20	24	24	C-SOCD202424	2,090
20	30	24	C-SOCD203024	2,197
20	36	24	C-SOCD203624	2,474
20	42	24	C-SOCD204224	2,569
20	48	24	C-SOCD204824	2,673
20	54	24	C-SOCD205424	2,882
20	60	24	C-SOCD206024	2,983
20	66	24	C-SOCD206624	3,088
20	72	24	C-SOCD207224	3,296

SPINE CABINET N (24" DEEP)

H	W	D	Model Number	List
28	24	24	C-SOCD282424	2,433
28	30	24	C-SOCD283024	2,557
28	36	24	C-SOCD283624	2,878
28	42	24	C-SOCD284224	2,988
28	48	24	C-SOCD284824	3,111
28	54	24	C-SOCD285424	3,353
28	60	24	C-SOCD286024	3,471
28	66	24	C-SOCD286624	3,593
28	72	24	C-SOCD287224	3,833
36	24	24	C-SOCD362424	2,816
36	30	24	C-SOCD363024	2,960
36	36	24	C-SOCD363624	3,331
36	42	24	C-SOCD364224	3,459
36	48	24	C-SOCD364824	3,601
36	54	24	C-SOCD365424	3,881
36	60	24	C-SOCD366024	4,018
36	66	24	C-SOCD366624	4,161
36	72	24	C-SOCD367224	4,437

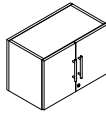

16" High, 24 - 48" Widths

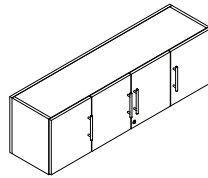

16" High, 54 - 72" Widths

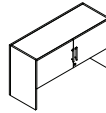

20 - 36" High, 24 - 48" Widths

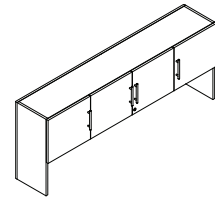

20 - 36" High, 54 - 72" Widths

Specify

- Laminate Selection for Doors
- Laminate Selection for Case
- Choice of Handle

Notes

- Compatible with Hutch A tackboards.
- Cabinets do not have shelves.
- 24 - 48" wide units feature two doors, units 54" wide and above feature four doors.

Spine Hutches with Sliding Doors

SPINE HUTCHES WITH SLIDING DOORS (14" DEEP)					
H	W	D	Left-Side Lock	Right-Side Lock	List
			Model Number	Model Number	
16	24	14	C-SOSDL162414	C-SOSDR162414	1,846
16	30	14	C-SOSDL163014	C-SOSDR163014	1,928
16	36	14	C-SOSDL163614	C-SOSDR163614	2,143
16	42	14	C-SOSDL164214	C-SOSDR164214	2,216
16	48	14	C-SOSDL164814	C-SOSDR164814	2,298
16	54	14	C-SOSDL165414	C-SOSDR165414	2,457
16	60	14	C-SOSDL166014	C-SOSDR166014	2,537
16	66	14	C-SOSDL166614	C-SOSDR166614	2,618
16	72	14	C-SOSDL167214	C-SOSDR167214	2,778
20	24	14	C-SOSDL202414	C-SOSDR202414	2,154
20	30	14	C-SOSDL203014	C-SOSDR203014	2,249
20	36	14	C-SOSDL203614	C-SOSDR203614	2,500
20	42	14	C-SOSDL204214	C-SOSDR204214	2,584
20	48	14	C-SOSDL204814	C-SOSDR204814	2,679
20	54	14	C-SOSDL205414	C-SOSDR205414	2,866
20	60	14	C-SOSDL206014	C-SOSDR206014	2,958
20	66	14	C-SOSDL206614	C-SOSDR206614	3,054
20	72	14	C-SOSDL207214	C-SOSDR207214	3,239

SPINE HUTCHES WITH SLIDING DOORS (14" DEEP)					
H	W	D	Left-Side Lock	Right-Side Lock	List
			Model Number	Model Number	
28	24	14	C-SOSDL282414	C-SOSDR282414	2,511
28	30	14	C-SOSDL283014	C-SOSDR283014	2,623
28	36	14	C-SOSDL283614	C-SOSDR283614	2,914
28	42	14	C-SOSDL284214	C-SOSDR284214	3,014
28	48	14	C-SOSDL284814	C-SOSDR284814	3,125
28	54	14	C-SOSDL285414	C-SOSDR285414	3,343
28	60	14	C-SOSDL286014	C-SOSDR286014	3,450
28	66	14	C-SOSDL286614	C-SOSDR286614	3,561
28	72	14	C-SOSDL287214	C-SOSDR287214	3,778
36	24	14	C-SOSDL362414	C-SOSDR362414	2,914
36	30	14	C-SOSDL363014	C-SOSDR363014	3,045
36	36	14	C-SOSDL363614	C-SOSDR363614	3,383
36	42	14	C-SOSDL364214	C-SOSDR364214	3,498
36	48	14	C-SOSDL364814	C-SOSDR364814	3,626
36	54	14	C-SOSDL365414	C-SOSDR365414	3,880
36	60	14	C-SOSDL366014	C-SOSDR366014	4,004
36	66	14	C-SOSDL366614	C-SOSDR366614	4,134
36	72	14	C-SOSDL367214	C-SOSDR367214	4,385

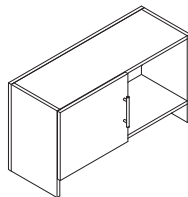

Left-Side Lock

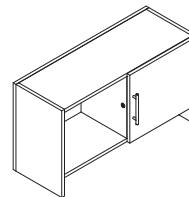

Right-Side Lock

Specify

Notes

- Laminate Selection for Doors
- Laminate Selection for Case
- Choice of Handle

Spine Hutches with Sliding Doors

SPINE HUTCHES WITH SLIDING DOORS (18" DEEP)					
H	W	D	Left-Side Lock	Right-Side Lock	List
			Model Number	Model Number	
16	24	18	C-SOSDL162418	C-SOSDR162418	1,943
16	30	18	C-SOSDL163018	C-SOSDR163018	2,030
16	36	18	C-SOSDL163618	C-SOSDR163618	2,256
16	42	18	C-SOSDL164218	C-SOSDR164218	2,332
16	48	18	C-SOSDL164818	C-SOSDR164818	2,419
16	54	18	C-SOSDL165418	C-SOSDR165418	2,587
16	60	18	C-SOSDL166018	C-SOSDR166018	2,670
16	66	18	C-SOSDL166618	C-SOSDR166618	2,756
16	72	18	C-SOSDL167218	C-SOSDR167218	2,924
20	24	18	C-SOSDL202418	C-SOSDR202418	2,266
20	30	18	C-SOSDL203018	C-SOSDR203018	2,368
20	36	18	C-SOSDL203618	C-SOSDR203618	2,630
20	42	18	C-SOSDL204218	C-SOSDR204218	2,720
20	48	18	C-SOSDL204818	C-SOSDR204818	2,820
20	54	18	C-SOSDL205418	C-SOSDR205418	3,017
20	60	18	C-SOSDL206018	C-SOSDR206018	3,114
20	66	18	C-SOSDL206618	C-SOSDR206618	3,215
20	72	18	C-SOSDL207218	C-SOSDR207218	3,410

SPINE HUTCHES WITH SLIDING DOORS (18" DEEP)					
H	W	D	Left-Side Lock	Right-Side Lock	List
			Model Number	Model Number	
28	24	18	C-SOSDL282418	C-SOSDR282418	2,643
28	30	18	C-SOSDL283018	C-SOSDR283018	2,762
28	36	18	C-SOSDL283618	C-SOSDR283618	3,068
28	42	18	C-SOSDL284218	C-SOSDR284218	3,172
28	48	18	C-SOSDL284818	C-SOSDR284818	3,289
28	54	18	C-SOSDL285418	C-SOSDR285418	3,519
28	60	18	C-SOSDL286018	C-SOSDR286018	3,631
28	66	18	C-SOSDL286618	C-SOSDR286618	3,749
28	72	18	C-SOSDL287218	C-SOSDR287218	3,978
36	24	18	C-SOSDL362418	C-SOSDR362418	3,059
36	30	18	C-SOSDL363018	C-SOSDR363018	3,196
36	36	18	C-SOSDL363618	C-SOSDR363618	3,552
36	42	18	C-SOSDL364218	C-SOSDR364218	3,672
36	48	18	C-SOSDL364818	C-SOSDR364818	3,807
36	54	18	C-SOSDL365418	C-SOSDR365418	4,073
36	60	18	C-SOSDL366018	C-SOSDR366018	4,205
36	66	18	C-SOSDL366618	C-SOSDR366618	4,339
36	72	18	C-SOSDL367218	C-SOSDR367218	4,605

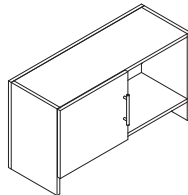

Left-Side Lock

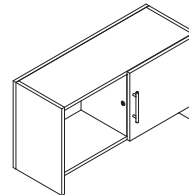

Right-Side Lock

Specify

Notes

- Laminate Selection for Doors
- Laminate Selection for Case
- Choice of Handle

Spine Hutches with Sliding Doors

SPINE HUTCHES WITH SLIDING DOORS (24" DEEP)					
H	W	D	Left-Side Lock	Right-Side Lock	List
			Model Number	Model Number	
16	24	24	C-SOSDL162424	C-SOSDR162424	2,046
16	30	24	C-SOSDL163024	C-SOSDR163024	2,137
16	36	24	C-SOSDL163624	C-SOSDR163624	2,373
16	42	24	C-SOSDL164224	C-SOSDR164224	2,454
16	48	24	C-SOSDL164824	C-SOSDR164824	2,545
16	54	24	C-SOSDL165424	C-SOSDR165424	2,723
16	60	24	C-SOSDL166024	C-SOSDR166024	2,811
16	66	24	C-SOSDL166624	C-SOSDR166624	2,901
16	72	24	C-SOSDL167224	C-SOSDR167224	3,077
20	24	24	C-SOSDL202424	C-SOSDR202424	2,386
20	30	24	C-SOSDL203024	C-SOSDR203024	2,492
20	36	24	C-SOSDL203624	C-SOSDR203624	2,770
20	42	24	C-SOSDL204224	C-SOSDR204224	2,864
20	48	24	C-SOSDL204824	C-SOSDR204824	2,968
20	54	24	C-SOSDL205424	C-SOSDR205424	3,176
20	60	24	C-SOSDL206024	C-SOSDR206024	3,278
20	66	24	C-SOSDL206624	C-SOSDR206624	3,384
20	72	24	C-SOSDL207224	C-SOSDR207224	3,589

SPINE HUTCHES WITH SLIDING DOORS (24" DEEP)					
H	W	D	Left-Side Lock	Right-Side Lock	List
			Model Number	Model Number	
28	24	24	C-SOSDL282424	C-SOSDR282424	2,775
28	30	24	C-SOSDL283024	C-SOSDR283024	2,900
28	36	24	C-SOSDL283624	C-SOSDR283624	3,222
28	42	24	C-SOSDL284224	C-SOSDR284224	3,330
28	48	24	C-SOSDL284824	C-SOSDR284824	3,454
28	54	24	C-SOSDL285424	C-SOSDR285424	3,694
28	60	24	C-SOSDL286024	C-SOSDR286024	3,813
28	66	24	C-SOSDL286624	C-SOSDR286624	3,936
28	72	24	C-SOSDL287224	C-SOSDR287224	4,176
36	24	24	C-SOSDL362424	C-SOSDR362424	3,213
36	30	24	C-SOSDL363024	C-SOSDR363024	3,357
36	36	24	C-SOSDL363624	C-SOSDR363624	3,730
36	42	24	C-SOSDL364224	C-SOSDR364224	3,855
36	48	24	C-SOSDL364824	C-SOSDR364824	3,999
36	54	24	C-SOSDL365424	C-SOSDR365424	4,277
36	60	24	C-SOSDL366024	C-SOSDR366024	4,414
36	66	24	C-SOSDL366624	C-SOSDR366624	4,557
36	72	24	C-SOSDL367224	C-SOSDR367224	4,835

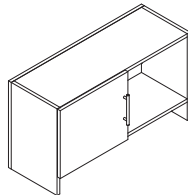

Left-Side Lock

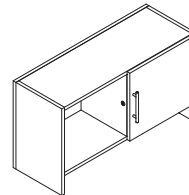

Right-Side Lock

Specify

Notes

- Laminate Selection for Doors
- Laminate Selection for Case
- Choice of Handle

SPINE BOOKCASES (18" DEEP)

H	W	D	Model Number	List
37	18	18	X-SOBC371818	1,480
37	24	18	X-SOBC372418	1,555
37	30	18	X-SOBC373018	1,632
37	36	18	X-SOBC373618	1,713
45	18	18	X-SOBC451818	1,544
45	24	18	X-SOBC452418	1,622
45	30	18	X-SOBC453018	1,703
45	36	18	X-SOBC453618	1,787

SPINE BOOKCASES (24" DEEP)

H	W	D	Model Number	List
37	18	24	X-SOBC371824	1,555
37	24	24	X-SOBC372424	1,632
37	30	24	X-SOBC373024	1,713
37	36	24	X-SOBC373624	1,799
45	18	24	X-SOBC451824	1,622
45	24	24	X-SOBC452424	1,703
45	30	24	X-SOBC453024	1,787
45	36	24	X-SOBC453624	1,876

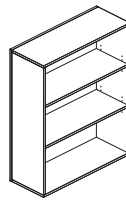

Specify

• Laminate Selection

Notes

• Shelves are adjustable.

Spine Bookcases with Sliding Doors

SPINE BOOKCASES WITH SLIDING DOORS (14" DEEP)					
H	W	D	Left-Side Lock	Right-Side Lock	List
			Model Number	Model Number	
16	30	14	X-SOSDL163014	X-SOSDR163014	2,022
16	36	14	X-SOSDL163614	X-SOSDR163614	2,081
16	42	14	X-SOSDL164214	X-SOSDR164214	2,154
16	48	14	X-SOSDL164814	X-SOSDR164814	2,261
16	54	14	X-SOSDL165414	X-SOSDR165414	2,373
16	60	14	X-SOSDL166014	X-SOSDR166014	2,492
20	30	14	X-SOSDL203014	X-SOSDR203014	2,128
20	36	14	X-SOSDL203614	X-SOSDR203614	2,191
20	42	14	X-SOSDL204214	X-SOSDR204214	2,266
20	48	14	X-SOSDL204814	X-SOSDR204814	2,380
20	54	14	X-SOSDL205414	X-SOSDR205414	2,499
20	60	14	X-SOSDL206014	X-SOSDR206014	2,624
24	30	14	X-SOSDL243014	X-SOSDR243014	2,239
24	36	14	X-SOSDL243614	X-SOSDR243614	2,306
24	42	14	X-SOSDL244214	X-SOSDR244214	2,386
24	48	14	X-SOSDL244814	X-SOSDR244814	2,506
24	54	14	X-SOSDL245414	X-SOSDR245414	2,630
24	60	14	X-SOSDL246014	X-SOSDR246014	2,762

SPINE BOOKCASES WITH SLIDING DOORS (14" DEEP)					
H	W	D	Left-Side Lock	Right-Side Lock	List
			Model Number	Model Number	
28	30	14	X-SOSDL283014	X-SOSDR283014	2,357
28	36	14	X-SOSDL283614	X-SOSDR283614	2,428
28	42	14	X-SOSDL284214	X-SOSDR284214	2,511
28	48	14	X-SOSDL284814	X-SOSDR284814	2,638
28	54	14	X-SOSDL285414	X-SOSDR285414	2,770
28	60	14	X-SOSDL286014	X-SOSDR286014	2,907
36	30	14	X-SOSDL363014	X-SOSDR363014	2,481
36	36	14	X-SOSDL363614	X-SOSDR363614	2,555
36	42	14	X-SOSDL364214	X-SOSDR364214	2,643
36	48	14	X-SOSDL364814	X-SOSDR364814	2,775
36	54	14	X-SOSDL365414	X-SOSDR365414	2,914
36	60	14	X-SOSDL366014	X-SOSDR366014	3,059

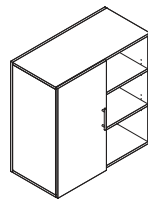

Left-Side Lock

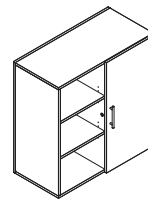

Right-Side Lock

Specify

- Laminate Selection for Doors
- Laminate Selection for Case
- Choice of Handle

Notes

- Shelves are adjustable.
- Features lockable doors.

Spine Bookcases with Sliding Doors

SPINE BOOKCASES WITH SLIDING DOORS (18" DEEP)

H	W	D	Left-Side Lock		Right-Side Lock	
			Model Number	Model Number	List	
16	30	18	X-SOSDL163018	X-SOSDR163018	2,122	
16	36	18	X-SOSDL163618	X-SOSDR163618	2,186	
16	42	18	X-SOSDL164218	X-SOSDR164218	2,261	
16	48	18	X-SOSDL164818	X-SOSDR164818	2,373	
16	54	18	X-SOSDL165418	X-SOSDR165418	2,492	
16	60	18	X-SOSDL166018	X-SOSDR166018	2,617	
20	30	18	X-SOSDL203018	X-SOSDR203018	2,234	
20	36	18	X-SOSDL203618	X-SOSDR203618	2,301	
20	42	18	X-SOSDL204218	X-SOSDR204218	2,380	
20	48	18	X-SOSDL204818	X-SOSDR204818	2,499	
20	54	18	X-SOSDL205418	X-SOSDR205418	2,624	
20	60	18	X-SOSDL206018	X-SOSDR206018	2,754	
24	30	18	X-SOSDL243018	X-SOSDR243018	2,352	
24	36	18	X-SOSDL243618	X-SOSDR243618	2,422	
24	42	18	X-SOSDL244218	X-SOSDR244218	2,506	
24	48	18	X-SOSDL244818	X-SOSDR244818	2,630	
24	54	18	X-SOSDL245418	X-SOSDR245418	2,762	
24	60	18	X-SOSDL246018	X-SOSDR246018	2,900	

SPINE BOOKCASES WITH SLIDING DOORS (18" DEEP)

H	W	D	Left-Side Lock		Right-Side Lock	
			Model Number	Model Number	List	
28	30	18	X-SOSDL283018	X-SOSDR283018	2,476	
28	36	18	X-SOSDL283618	X-SOSDR283618	2,549	
28	42	18	X-SOSDL284218	X-SOSDR284218	2,638	
28	48	18	X-SOSDL284818	X-SOSDR284818	2,770	
28	54	18	X-SOSDL285418	X-SOSDR285418	2,907	
28	60	18	X-SOSDL286018	X-SOSDR286018	3,053	
36	30	18	X-SOSDL363018	X-SOSDR363018	2,605	
36	36	18	X-SOSDL363618	X-SOSDR363618	2,683	
36	42	18	X-SOSDL364218	X-SOSDR364218	2,775	
36	48	18	X-SOSDL364818	X-SOSDR364818	2,914	
36	54	18	X-SOSDL365418	X-SOSDR365418	3,059	
36	60	18	X-SOSDL366018	X-SOSDR366018	3,213	

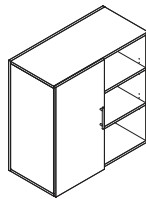

Left-Side Lock

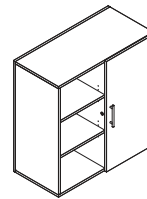

Right-Side Lock

Specify

- Laminate Selection for Doors
- Laminate Selection for Case
- Choice of Handle

Notes

- Shelves are adjustable.
- Features lockable doors.

Spine Bookcases with Sliding Doors

SPINE BOOKCASES WITH SLIDING DOORS (24" DEEP)					
H	W	D	Left-Side Lock	Right-Side Lock	List
			Model Number	Model Number	
16	30	24	X-SOSDL163024	X-SOSDR163024	2,229
16	36	24	X-SOSDL163624	X-SOSDR163624	2,295
16	42	24	X-SOSDL164224	X-SOSDR164224	2,373
16	48	24	X-SOSDL164824	X-SOSDR164824	2,492
16	54	24	X-SOSDL165424	X-SOSDR165424	2,617
16	60	24	X-SOSDL166024	X-SOSDR166024	2,748
20	30	24	X-SOSDL203024	X-SOSDR203024	2,346
20	36	24	X-SOSDL203624	X-SOSDR203624	2,416
20	42	24	X-SOSDL204224	X-SOSDR204224	2,499
20	48	24	X-SOSDL204824	X-SOSDR204824	2,624
20	54	24	X-SOSDL205424	X-SOSDR205424	2,754
20	60	24	X-SOSDL206024	X-SOSDR206024	2,893
24	30	24	X-SOSDL243024	X-SOSDR243024	2,469
24	36	24	X-SOSDL243624	X-SOSDR243624	2,543
24	42	24	X-SOSDL244224	X-SOSDR244224	2,630
24	48	24	X-SOSDL244824	X-SOSDR244824	2,762
24	54	24	X-SOSDL245424	X-SOSDR245424	2,900
24	60	24	X-SOSDL246024	X-SOSDR246024	3,045

SPINE BOOKCASES WITH SLIDING DOORS (24" DEEP)					
H	W	D	Left-Side Lock	Right-Side Lock	List
			Model Number	Model Number	
28	30	24	X-SOSDL283024	X-SOSDR283024	2,599
28	36	24	X-SOSDL283624	X-SOSDR283624	2,676
28	42	24	X-SOSDL284224	X-SOSDR284224	2,770
28	48	24	X-SOSDL284824	X-SOSDR284824	2,907
28	54	24	X-SOSDL285424	X-SOSDR285424	3,053
28	60	24	X-SOSDL286024	X-SOSDR286024	3,205
36	30	24	X-SOSDL363024	X-SOSDR363024	2,735
36	36	24	X-SOSDL363624	X-SOSDR363624	2,817
36	42	24	X-SOSDL364224	X-SOSDR364224	2,914
36	48	24	X-SOSDL364824	X-SOSDR364824	3,059
36	54	24	X-SOSDL365424	X-SOSDR365424	3,213
36	60	24	X-SOSDL366024	X-SOSDR366024	3,374

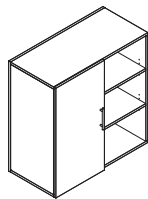

Left-Side Lock

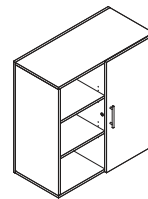

Right-Side Lock

Specify

- Laminate Selection for Doors
- Laminate Selection for Case
- Choice of Handle

Notes

- Shelves are adjustable.
- Features lockable doors.

Spine Stack-On Two Door Cabinet

SPINE STACK-ON TWO DOOR CABINET

H	W	D	Model Number	List
37	30	18	X-SOCD373018	2,210
37	30	24	X-SOCD373024	2,222
37	36	18	X-SOCD373618	2,307
37	36	24	X-SOCD373624	2,319

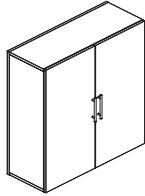

Specify

Notes

- Laminate Selection for Case
- Laminate Selection for Doors/Face
- Handle Choice

- All cabinets have a divider and four adjustable shelves.

Spine Hutch A

SPINE HUTCH A (18" DEEP)					SPINE HUTCH A (24" DEEP)				
H	W	D	Model Number	List	H	W	D	Model Number	List
12	24	18	C-CSH122418A	1,096	12	24	24	C-CSH122424A	1,198
12	30	18	C-CSH123018A	1,208	12	30	24	C-CSH123024A	1,296
12	36	18	C-CSH123618A	1,261	12	36	24	C-CSH123624A	1,361
12	42	18	C-CSH124218A	1,315	12	42	24	C-CSH124224A	1,428
12	48	18	C-CSH124818A	1,430	12	48	24	C-CSH124824A	1,556
12	54	18	C-CSH125418A	1,482	12	54	24	C-CSH125424A	1,622
12	60	18	C-CSH126018A	1,536	12	60	24	C-CSH126024A	1,686
12	66	18	C-CSH126618A	1,652	12	66	24	C-CSH126624A	1,815
12	72	18	C-CSH127218A	1,705	12	72	24	C-CSH127224A	1,882
16	24	18	C-CSH162418A	1,138	16	24	24	C-CSH162424A	1,222
16	30	18	C-CSH163018A	1,257	16	30	24	C-CSH163024A	1,354
16	36	18	C-CSH163618A	1,315	16	36	24	C-CSH163624A	1,424
16	42	18	C-CSH164218A	1,372	16	42	24	C-CSH164224A	1,494
16	48	18	C-CSH164818A	1,493	16	48	24	C-CSH164824A	1,626
16	54	18	C-CSH165418A	1,550	16	54	24	C-CSH165424A	1,696
16	60	18	C-CSH166018A	1,610	16	60	24	C-CSH166024A	1,767
16	66	18	C-CSH166618A	1,728	16	66	24	C-CSH166624A	1,902
16	72	18	C-CSH167218A	1,787	16	72	24	C-CSH167224A	1,973
20	24	18	C-CSH202418A	1,182	20	24	24	C-CSH202424A	1,275
20	30	18	C-CSH203018A	1,304	20	30	24	C-CSH203024A	1,410
20	36	18	C-CSH203618A	1,366	20	36	24	C-CSH203624A	1,483
20	42	18	C-CSH204218A	1,429	20	42	24	C-CSH204224A	1,559
20	48	18	C-CSH204818A	1,554	20	48	24	C-CSH204824A	1,696
20	54	18	C-CSH205418A	1,616	20	54	24	C-CSH205424A	1,772
20	60	18	C-CSH206018A	1,680	20	60	24	C-CSH206024A	1,846
20	66	18	C-CSH206618A	1,805	20	66	24	C-CSH206624A	1,984
20	72	18	C-CSH207218A	1,867	20	72	24	C-CSH207224A	2,059

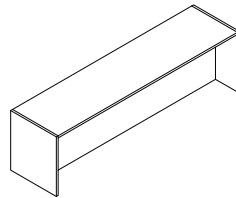

Specify

Notes

- Laminate Selection for Case
- Laminate Selection for Divider

- Provides storage and space division facing front and back.
- Unit provided with rubber high friction strips for retention.

SPINE HUTCH A (18" DEEP)					SPINE HUTCH A (24" DEEP)				
H	W	D	Model Number	List	H	W	D	Model Number	List
28	24	18	C-CSH282418A	1,275	28	24	24	C-CSH282424A	1,384
28	30	18	C-CSH283018A	1,406	28	30	24	C-CSH283024A	1,529
28	36	18	C-CSH283618A	1,479	28	36	24	C-CSH283624A	1,613
28	42	18	C-CSH284218A	1,550	28	42	24	C-CSH284224A	1,696
28	48	18	C-CSH284818A	1,684	28	48	24	C-CSH284824A	1,844
28	54	18	C-CSH285418A	1,757	28	54	24	C-CSH285424A	1,928
28	60	18	C-CSH286018A	1,829	28	60	24	C-CSH286024A	2,013
28	66	18	C-CSH286618A	1,963	28	66	24	C-CSH286624A	2,159
28	72	18	C-CSH287218A	2,035	28	72	24	C-CSH287224A	2,243
36	24	18	C-CSH362418A	1,460	36	24	24	C-CSH362424A	1,603
36	30	18	C-CSH363018A	1,610	36	30	24	C-CSH363024A	1,765
36	36	18	C-CSH363618A	1,703	36	36	24	C-CSH363624A	1,871
36	42	18	C-CSH364218A	1,792	36	42	24	C-CSH364224A	1,974
36	48	18	C-CSH364818A	1,944	36	48	24	C-CSH364824A	2,138
36	54	18	C-CSH365418A	2,037	36	54	24	C-CSH365424A	2,243
36	60	18	C-CSH366018A	2,128	36	60	24	C-CSH366024A	2,341
36	66	18	C-CSH366618A	2,277	36	66	24	C-CSH366624A	2,507
36	72	18	C-CSH367218A	2,372	36	72	24	C-CSH367224A	2,613

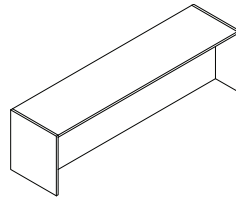

Specify	Notes
<ul style="list-style-type: none"> • Laminate Selection for Case • Laminate Selection for Divider 	<ul style="list-style-type: none"> • Provides storage and space division facing front and back. • Unit provided with rubber high friction strips for retention.

Spine Hutch B

SPINE HUTCH B (18" DEEP)						SPINE HUTCH B (24" DEEP)					
H	W	D	Open Left	Open Right	List	H	W	D	Open Left	Open Right	List
			Model Number	Model Number					Model Number	Model Number	
12	36	18	C-CSH123618BL	C-CSH123618BR	1,479	12	36	24	C-CSH123624BL	C-CSH123624BR	1,626
12	42	18	C-CSH124218BL	C-CSH124218BR	1,544	12	42	24	C-CSH124224BL	C-CSH124224BR	1,707
12	48	18	C-CSH124818BL	C-CSH124818BR	1,610	12	48	24	C-CSH124824BL	C-CSH124824BR	1,789
12	54	18	C-CSH125418BL	C-CSH125418BR	1,674	12	54	24	C-CSH125424BL	C-CSH125424BR	1,871
12	60	18	C-CSH126018BL	C-CSH126018BR	1,859	12	60	24	C-CSH126024BL	C-CSH126024BR	2,071
12	66	18	C-CSH126618BL	C-CSH126618BR	1,924	12	66	24	C-CSH126624BL	C-CSH126624BR	2,151
12	72	18	C-CSH127218BL	C-CSH127218BR	1,989	12	72	24	C-CSH127224BL	C-CSH127224BR	2,235
16	36	18	C-CSH163618BL	C-CSH163618BR	1,570	16	36	24	C-CSH163624BL	C-CSH163624BR	1,733
16	42	18	C-CSH164218BL	C-CSH164218BR	1,640	16	42	24	C-CSH164224BL	C-CSH164224BR	1,818
16	48	18	C-CSH164818BL	C-CSH164818BR	1,708	16	48	24	C-CSH164824BL	C-CSH164824BR	1,906
16	54	18	C-CSH165418BL	C-CSH165418BR	1,778	16	54	24	C-CSH165424BL	C-CSH165424BR	1,990
16	60	18	C-CSH166018BL	C-CSH166018BR	1,969	16	60	24	C-CSH166024BL	C-CSH166024BR	2,199
16	66	18	C-CSH166618BL	C-CSH166618BR	2,040	16	66	24	C-CSH166624BL	C-CSH166624BR	2,285
16	72	18	C-CSH167218BL	C-CSH167218BR	2,110	16	72	24	C-CSH167224BL	C-CSH167224BR	2,370
20	36	18	C-CSH203618BL	C-CSH203618BR	1,646	20	36	24	C-CSH203624BL	C-CSH203624BR	1,827
20	42	18	C-CSH204218BL	C-CSH204218BR	1,722	20	42	24	C-CSH204224BL	C-CSH204224BR	1,917
20	48	18	C-CSH204818BL	C-CSH204818BR	1,799	20	48	24	C-CSH204824BL	C-CSH204824BR	2,009
20	54	18	C-CSH205418BL	C-CSH205418BR	1,874	20	54	24	C-CSH205424BL	C-CSH205424BR	2,101
20	60	18	C-CSH206018BL	C-CSH206018BR	2,070	20	60	24	C-CSH206024BL	C-CSH206024BR	2,313
20	66	18	C-CSH206618BL	C-CSH206618BR	2,145	20	66	24	C-CSH206624BL	C-CSH206624BR	2,406
20	72	18	C-CSH207218BL	C-CSH207218BR	2,221	20	72	24	C-CSH207224BL	C-CSH207224BR	2,497

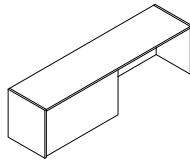

12 - 20" High
Open Right

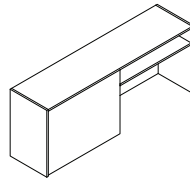

28" High
Open Right

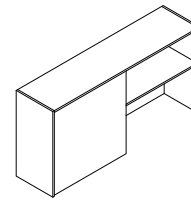

36" High
Open Right

Specify

- Laminate Selection for Case
- Laminate Selection for Divider

Notes

- Provides storage and space division facing front and back.
- Unit provided with rubber high friction strips for retention.
- Divider can be ordered as HPL Whiteboard. Divider is always same color on both sides.
- 28" high units feature a 8" high cubby shelf, 36" high units feature a 16" high cubby shelf.

SPINE HUTCH B (18" DEEP)						SPINE HUTCH B (24" DEEP)					
H	W	D	Open Left	Open Right	List	H	W	D	Open Left	Open Right	List
			Model Number	Model Number					Model Number	Model Number	
28	36	18	C-CSH283618BL	C-CSH283618BR	1,806	28	36	24	C-CSH283624BL	C-CSH283624BR	2,018
28	42	18	C-CSH284218BL	C-CSH284218BR	1,893	28	42	24	C-CSH284224BL	C-CSH284224BR	2,121
28	48	18	C-CSH284818BL	C-CSH284818BR	1,979	28	48	24	C-CSH284824BL	C-CSH284824BR	2,224
28	54	18	C-CSH285418BL	C-CSH285418BR	2,065	28	54	24	C-CSH285424BL	C-CSH285424BR	2,326
28	60	18	C-CSH286018BL	C-CSH286018BR	2,272	28	60	24	C-CSH286024BL	C-CSH286024BR	2,549
28	66	18	C-CSH286618BL	C-CSH286618BR	2,359	28	66	24	C-CSH286624BL	C-CSH286624BR	2,652
28	72	18	C-CSH287218BL	C-CSH287218BR	2,443	28	72	24	C-CSH287224BL	C-CSH287224BR	2,753
36	36	18	C-CSH363618BL	C-CSH363618BR	2,127	36	36	24	C-CSH363624BL	C-CSH363624BR	2,400
36	42	18	C-CSH364218BL	C-CSH364218BR	2,237	36	42	24	C-CSH364224BL	C-CSH364224BR	2,527
36	48	18	C-CSH364818BL	C-CSH364818BR	2,340	36	48	24	C-CSH364824BL	C-CSH364824BR	2,653
36	54	18	C-CSH365418BL	C-CSH365418BR	2,447	36	54	24	C-CSH365424BL	C-CSH365424BR	2,772
36	60	18	C-CSH366018BL	C-CSH366018BR	2,673	36	60	24	C-CSH366024BL	C-CSH366024BR	3,020
36	66	18	C-CSH366618BL	C-CSH366618BR	2,785	36	66	24	C-CSH366624BL	C-CSH366624BR	3,143
36	72	18	C-CSH367218BL	C-CSH367218BR	2,892	36	72	24	C-CSH367224BL	C-CSH367224BR	3,265

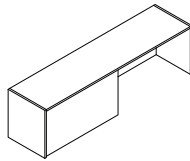

12 - 20" High
Open Right

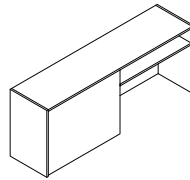

28" High
Open Right

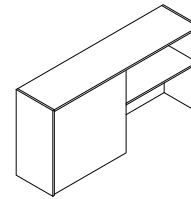

36" High
Open Right

Specify

- Laminate Selection for Case
- Laminate Selection for Divider

Notes

- Provides storage and space division facing front and back.
- Unit provided with rubber high friction strips for retention.
- Divider can be ordered as HPL Whiteboard. Divider is always same color on both sides.
- 28" high units feature a 8" high cubby shelf, 36" high units feature a 16" high cubby shelf.

Spine Hutch C

SPINE HUTCH C (24" DEEP)

H	W	D	Model Number	List
20	24	24	C-CSH202424C	1,896
20	30	24	C-CSH203024C	2,029
20	36	24	C-CSH203624C	2,211
20	42	24	C-CSH204224C	2,337
20	48	24	C-CSH204824C	2,477
20	54	24	C-CSH205424C	2,719
20	60	24	C-CSH206024C	2,842
20	66	24	C-CSH206624C	2,983
20	72	24	C-CSH207224C	3,223
20	78	24	C-CSH207824C	3,347
20	84	24	C-CSH208424C	3,472

SPINE HUTCH C (30" DEEP)

H	W	D	Model Number	List
20	24	30	C-CSH202430C	1,896
20	30	30	C-CSH203030C	2,029
20	36	30	C-CSH203630C	2,211
20	42	30	C-CSH204230C	2,337
20	48	30	C-CSH204830C	2,477
20	54	30	C-CSH205430C	2,719
20	60	30	C-CSH206030C	2,842
20	66	30	C-CSH206630C	2,983
20	72	30	C-CSH207230C	3,223
20	78	30	C-CSH207830C	3,347
20	84	30	C-CSH208430C	3,472

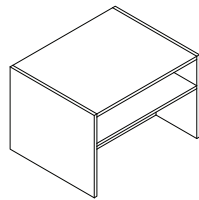

24 - 30" Wide

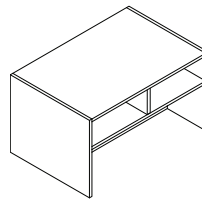

36 - 84" Wide

Specify

- Laminate Selection

Notes

- Provides storage and space division facing two sides.
- 20" high unit has 8" high cubby above. 28" high has 8" or 16" high cubby above. 36" high has 16" high cubby.
- Units 36" wide and over have a divider, 24 - 36" wide units do not have a divider.
- Unit provided with rubber high friction strips for retention.

SPINE HUTCH C WITH 8" HIGH CUBBY SHELF (24" DEEP)

H	W	D	Cubby H	Model Number	List
28	24	24	8	C-CSH282424C8	2,088
28	30	24	8	C-CSH283024C8	2,234
28	36	24	8	C-CSH283624C8	2,407
28	42	24	8	C-CSH284224C8	2,502
28	48	24	8	C-CSH284824C8	2,654
28	54	24	8	C-CSH285424C8	2,906
28	60	24	8	C-CSH286024C8	3,041
28	66	24	8	C-CSH286624C8	3,190
28	72	24	8	C-CSH287224C8	3,441
28	78	24	8	C-CSH287824C8	3,577
28	84	24	8	C-CSH288424C8	3,711
36	24	24	8	C-CSH362424C8	2,181
36	30	24	8	C-CSH363024C8	2,339
36	36	24	8	C-CSH363624C8	2,657
36	42	24	8	C-CSH364224C8	2,823
36	48	24	8	C-CSH364824C8	2,990
36	54	24	8	C-CSH365424C8	3,248
36	60	24	8	C-CSH366024C8	3,399
36	66	24	8	C-CSH366624C8	3,562
36	72	24	8	C-CSH367224C8	3,818
36	78	24	8	C-CSH367824C8	3,968
36	84	24	8	C-CSH368424C8	4,116

SPINE HUTCH C WITH 8" HIGH CUBBY SHELF (30" DEEP)

H	W	D	Cubby H	Model Number	List
28	24	30	8	C-CSH282430C8	2,088
28	30	30	8	C-CSH283030C8	2,234
28	36	30	8	C-CSH283630C8	2,367
28	42	30	8	C-CSH284230C8	2,502
28	48	30	8	C-CSH284830C8	2,654
28	54	30	8	C-CSH285430C8	2,906
28	60	30	8	C-CSH286030C8	3,041
28	66	30	8	C-CSH286630C8	3,190
28	72	30	8	C-CSH287230C8	3,441
28	78	30	8	C-CSH287830C8	3,577
28	84	30	8	C-CSH288430C8	3,711
36	24	30	8	C-CSH362430C8	2,292
36	30	30	8	C-CSH363030C8	2,451
36	36	30	8	C-CSH363630C8	2,587
36	42	30	8	C-CSH364230C8	2,734
36	48	30	8	C-CSH364830C8	2,901
36	54	30	8	C-CSH365430C8	3,158
36	60	30	8	C-CSH366030C8	3,310
36	66	30	8	C-CSH366630C8	3,472
36	72	30	8	C-CSH367230C8	3,729
36	78	30	8	C-CSH367830C8	3,879
36	84	30	8	C-CSH368430C8	4,029

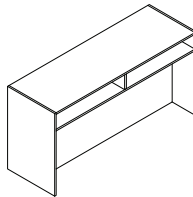

Specify

• Laminate Selection

Notes

- Provides storage and space division facing two sides.
- 20" high unit has 8" high cubby above. 28" high has 8" or 16" high cubby above. 36" high has 16" high cubby.
- Units 36" wide and over have a divider, 24 - 36" wide units do not have a divider.
- Unit provided with rubber high friction strips for retention.

Spine Hutch C

SPINE HUTCH C WITH 16" HIGH CUBBY SHELF (24" DEEP)

SPINE HUTCH C WITH 16" HIGH CUBBY SHELF (30" DEEP)

H	W	D	Cubby H	Model Number	List
28	24	24	16	C-CSH282424C16	2,030
28	30	24	16	C-CSH283024C16	2,173
28	36	24	16	C-CSH283624C16	2,329
28	42	24	16	C-CSH284224C16	2,549
28	48	24	16	C-CSH284824C16	2,700
28	54	24	16	C-CSH285424C16	2,952
28	60	24	16	C-CSH286024C16	3,087
28	66	24	16	C-CSH286624C16	3,239
28	72	24	16	C-CSH287224C16	3,488
28	78	24	16	C-CSH287824C16	3,625
28	84	24	16	C-CSH288424C16	3,760
36	24	24	16	C-CSH362424C16	2,298
36	30	24	16	C-CSH363024C16	2,462
36	36	24	16	C-CSH363624C16	2,797
36	42	24	16	C-CSH364224C16	2,973
36	48	24	16	C-CSH364824C16	3,148
36	54	24	16	C-CSH365424C16	3,420
36	60	24	16	C-CSH366024C16	3,579
36	66	24	16	C-CSH366624C16	3,750
36	72	24	16	C-CSH367224C16	4,020
36	78	24	16	C-CSH367824C16	4,178
36	84	24	16	C-CSH368424C16	4,333

H	W	D	Cubby H	Model Number	List
28	24	30	16	C-CSH282430C16	2,030
28	30	30	16	C-CSH283030C16	2,173
28	36	30	16	C-CSH283630C16	2,412
28	42	30	16	C-CSH284230C16	2,549
28	48	30	16	C-CSH284830C16	2,700
28	54	30	16	C-CSH285430C16	2,952
28	60	30	16	C-CSH286030C16	3,087
28	66	30	16	C-CSH286630C16	3,239
28	72	30	16	C-CSH287230C16	3,488
28	78	30	16	C-CSH287830C16	3,625
28	84	30	16	C-CSH288430C16	3,760
36	24	30	16	C-CSH362430C16	2,413
36	30	30	16	C-CSH363030C16	2,582
36	36	30	16	C-CSH363630C16	2,723
36	42	30	16	C-CSH364230C16	2,880
36	48	30	16	C-CSH364830C16	3,055
36	54	30	16	C-CSH365430C16	3,326
36	60	30	16	C-CSH366030C16	3,485
36	66	30	16	C-CSH366630C16	3,655
36	72	30	16	C-CSH367230C16	3,925
36	78	30	16	C-CSH367830C16	4,084
36	84	30	16	C-CSH368430C16	4,241

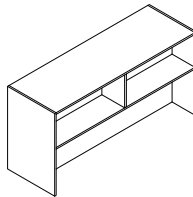

Specify

Notes

• Laminate Selection

- Provides storage and space division facing two sides.
- 20" high unit has 8" high cubby above. 28" high has 8" or 16" high cubby above. 36" high has 16" high cubby.
- Units 36" wide and over have a divider, 24 - 36" wide units do not have a divider.
- Unit provided with rubber high friction strips for retention.

SPINE HUTCH D (18" DEEP)					
H	W	D	Open Left	Open Right	List
			Model Number	Model Number	
20	36	18	C-CSH203618DL	C-CSH203618DR	1,995
20	42	18	C-CSH204218DL	C-CSH204218DR	2,096
20	48	18	C-CSH204818DL	C-CSH204818DR	2,168
20	54	18	C-CSH205418DL	C-CSH205418DR	2,415
20	60	18	C-CSH206018DL	C-CSH206018DR	2,521
20	66	18	C-CSH206618DL	C-CSH206618DR	2,627
20	72	18	C-CSH207218DL	C-CSH207218DR	2,843
20	78	18	C-CSH207818DL	C-CSH207818DR	2,943
20	84	18	C-CSH208418DL	C-CSH208418DR	3,054

SPINE HUTCH D WITH 8" HIGH CUBBY SHELF (18" DEEP)							
H	W	D	Shelf H	Open Left	Open Right	List	
				Model Number	Model Number		
28	36	18	8	C-CSH2836DL08	C-CSH2836DR08	2,128	
28	42	18	8	C-CSH2842DL08	C-CSH2842DR08	2,239	
28	48	18	8	C-CSH2848DL08	C-CSH2848DR08	2,356	
28	54	18	8	C-CSH2854DL08	C-CSH2854DR08	2,582	
28	60	18	8	C-CSH2860DL08	C-CSH2860DR08	2,696	
28	66	18	8	C-CSH2866DL08	C-CSH2866DR08	2,814	
28	72	18	8	C-CSH2872DL08	C-CSH2872DR08	3,041	
28	78	18	8	C-CSH2878DL08	C-CSH2878DR08	3,152	
28	84	18	8	C-CSH2884DL08	C-CSH2884DR08	3,273	
36	36	18	8	C-CSH3636DL8	C-CSH3636DR8	2,351	
36	42	18	8	C-CSH3642DL8	C-CSH3642DR8	2,476	
36	48	18	8	C-CSH3648DL8	C-CSH3648DR8	2,666	
36	54	18	8	C-CSH3654DL8	C-CSH3654DR8	2,843	
36	60	18	8	C-CSH3660DL8	C-CSH3660DR8	2,974	
36	66	18	8	C-CSH3666DL8	C-CSH3666DR8	3,102	
36	72	18	8	C-CSH3672DL8	C-CSH3672DR8	3,340	
36	78	18	8	C-CSH3678DL8	C-CSH3678DR8	3,466	
36	84	18	8	C-CSH3684DL8	C-CSH3684DR8	3,600	

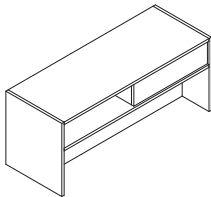

Open Left

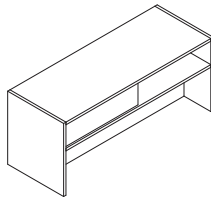

Open Right

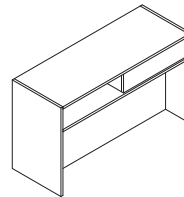

Open Left

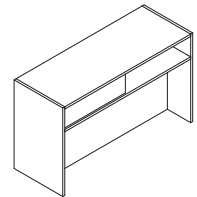

Open Right

Specify

- Laminate Selection for Case
- Laminate Selection for Divider

Notes

- Provides storage and space division facing two sides.
- Unit provided with rubber high friction strips for retention.
- Top Yin-Yang Divider can be ordered as HPL Whiteboard. Divider is same color on both sides.

Spine Hutch D

SPINE HUTCH D WITH 16" HIGH CUBBY SHELF

H	W	D	Shelf H	Open		List
				Left	Right	
				Model Number	Model Number	
28	36	18	16	C-CSH2836DL16	C-CSH2836DR16	2,154
28	42	18	16	C-CSH2842DL16	C-CSH2842DR16	2,265
28	48	18	16	C-CSH2848DL16	C-CSH2848DR16	2,381
28	54	18	16	C-CSH2854DL16	C-CSH2854DR16	2,609
28	60	18	16	C-CSH2860DL16	C-CSH2860DR16	2,724
28	66	18	16	C-CSH2866DL16	C-CSH2866DR16	2,841
28	72	18	16	C-CSH2872DL16	C-CSH2872DR16	3,067
28	78	18	16	C-CSH2878DL16	C-CSH2878DR16	3,178
28	84	18	16	C-CSH2884DL16	C-CSH2884DR16	3,299
36	36	18	16	C-CSH3636DL16	C-CSH3636DR16	2,474
36	42	18	16	C-CSH3642DL16	C-CSH3642DR16	2,605
36	48	18	16	C-CSH3648DL16	C-CSH3648DR16	2,808
36	54	18	16	C-CSH3654DL16	C-CSH3654DR16	2,993
36	60	18	16	C-CSH3660DL16	C-CSH3660DR16	3,129
36	66	18	16	C-CSH3666DL16	C-CSH3666DR16	3,266
36	72	18	16	C-CSH3672DL16	C-CSH3672DR16	3,517
36	78	18	16	C-CSH3678DL16	C-CSH3678DR16	3,649
36	84	18	16	C-CSH3684DL16	C-CSH3684DR16	3,790

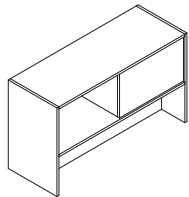

Open Left

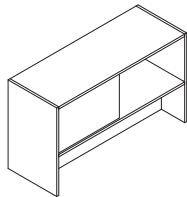

Open Right

Specify

- Laminate Selection for Case
- Laminate Selection for Divider

Notes

- Provides storage and space division facing two sides.
- Unit provided with rubber high friction strips for retention.
- Top Yin-Yang Divider can be ordered as HPL Whiteboard. Divider is same color on both sides.

SPINE HUTCH E (18" DEEP)						SPINE HUTCH E (24" DEEP)					
H	W	D	Door Left		List	H	W	D	Door Right		List
			Model Number	Model Number					Model Number	Model Number	
28	36	18	C-CSH283618EL	C-CSH283618ER	2,743	28	36	24	C-CSH283624EL	C-CSH283624ER	2,947
28	42	18	C-CSH284218EL	C-CSH284218ER	2,871	28	42	24	C-CSH284224EL	C-CSH284224ER	3,094
28	48	18	C-CSH284818EL	C-CSH284818ER	3,005	28	48	24	C-CSH284824EL	C-CSH284824ER	3,247
28	54	18	C-CSH285418EL	C-CSH285418ER	3,256	28	54	24	C-CSH285424EL	C-CSH285424ER	3,516
28	60	18	C-CSH286018EL	C-CSH286018ER	3,394	28	60	24	C-CSH286024EL	C-CSH286024ER	3,672
28	66	18	C-CSH286618EL	C-CSH286618ER	3,528	28	66	24	C-CSH286624EL	C-CSH286624ER	3,825
28	72	18	C-CSH287218EL	C-CSH287218ER	3,657	28	72	24	C-CSH287224EL	C-CSH287224ER	3,972
28	78	18	C-CSH287818EL	C-CSH287818ER	3,784	28	78	24	C-CSH287824EL	C-CSH287824ER	4,121
28	84	18	C-CSH288418EL	C-CSH288418ER	3,933	28	84	24	C-CSH288424EL	C-CSH288424ER	4,287
36	36	18	C-CSH363618EL	C-CSH363618ER	3,062	36	36	24	C-CSH363624EL	C-CSH363624ER	3,266
36	42	18	C-CSH364218EL	C-CSH364218ER	3,212	36	42	24	C-CSH364224EL	C-CSH364224ER	3,435
36	48	18	C-CSH364818EL	C-CSH364818ER	3,432	36	48	24	C-CSH364824EL	C-CSH364824ER	3,672
36	54	18	C-CSH365418EL	C-CSH365418ER	3,640	36	54	24	C-CSH365424EL	C-CSH365424ER	3,900
36	60	18	C-CSH366018EL	C-CSH366018ER	3,800	36	60	24	C-CSH366024EL	C-CSH366024ER	4,079
36	66	18	C-CSH366618EL	C-CSH366618ER	3,954	36	66	24	C-CSH366624EL	C-CSH366624ER	4,252
36	72	18	C-CSH367218EL	C-CSH367218ER	4,106	36	72	24	C-CSH367224EL	C-CSH367224ER	4,422
36	78	18	C-CSH367818EL	C-CSH367818ER	4,256	36	78	24	C-CSH367824EL	C-CSH367824ER	4,590
36	84	18	C-CSH368418EL	C-CSH368418ER	4,425	36	84	24	C-CSH368424EL	C-CSH368424ER	4,778

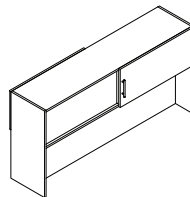

Door Right

Specify

Notes

- Laminate Selection for Case
- Laminate Selection for Divider
- Laminate Selection for Door
- Choice of Handle

- Provides storage and space division facing two sides with lockable sliding door.
- Unit provided with rubber high friction strips for retention.
- Top Yin-Yang Divider can be ordered as HPL Whiteboard. Divider is same color on both sides.

Spine Hutch H

SPINE HUTCH H (18" DEEP)											
				Cantilevered		Full Panel					
H	W	D	Cubby H	Model Number	List	Model Number	List				
20	60	18	8	C-CSH206018H	3,087	C-CSH206018HF	3,188				
20	66	18	8	C-CSH206618H	3,153	C-CSH206618HF	3,255				
20	72	18	8	C-CSH207218H	3,223	C-CSH207218HF	3,319				
20	78	18	8	C-CSH207818H	3,320	C-CSH207818HF	3,407				
20	84	18	8	C-CSH208418H	3,396	C-CSH208418HF	3,472				
28	60	18	8	C-CSH286018H	3,343	C-CSH286018HF	3,481				
28	66	18	8	C-CSH286618H	3,418	C-CSH286618HF	3,557				
28	72	18	8	C-CSH287218H	3,499	C-CSH287218HF	3,633				
28	78	18	8	C-CSH287818H	3,617	C-CSH287818HF	3,741				
28	84	18	8	C-CSH288418H	3,701	C-CSH288418HF	3,815				
36	60	18	8	C-CSH366018H8	3,419	C-CSH366018HF8	3,587				
36	66	18	8	C-CSH366618H8	3,500	C-CSH366618HF8	3,667				
36	72	18	8	C-CSH367218H8	3,583	C-CSH367218HF8	3,749				
36	78	18	8	C-CSH367818H8	3,718	C-CSH367818HF8	3,870				
36	84	18	8	C-CSH368418H8	3,804	C-CSH368418HF8	3,952				
36	60	18	16	C-CSH366018H	3,599	C-CSH366018HF	3,776				
36	66	18	16	C-CSH366618H	3,683	C-CSH366618HF	3,860				
36	72	18	16	C-CSH367218H	3,772	C-CSH367218HF	3,946				
36	78	18	16	C-CSH367818H	3,913	C-CSH367818HF	4,074				
36	84	18	16	C-CSH368418H	4,005	C-CSH368418HF	4,161				

SPINE HUTCH H (24" DEEP)											
				Cantilevered		Full Panel					
H	W	D	Cubby H	Model Number	List	Model Number	List	Model Number	List	Model Number	List
20	60	24	8	C-CSH206024H	3,325	C-CSH206024HF	3,426				
20	66	24	8	C-CSH206624H	3,405	C-CSH206624HF	3,506				
20	72	24	8	C-CSH207224H	3,488	C-CSH207224HF	3,586				
20	78	24	8	C-CSH207824H	3,601	C-CSH207824HF	3,687				
20	84	24	8	C-CSH208424H	3,690	C-CSH208424HF	3,766				
28	60	24	8	C-CSH286024H	3,610	C-CSH286024HF	3,748				
28	66	24	8	C-CSH286624H	3,698	C-CSH286624HF	3,839				
28	72	24	8	C-CSH287224H	3,793	C-CSH287224HF	3,927				
28	78	24	8	C-CSH287824H	3,925	C-CSH287824HF	4,049				
28	84	24	8	C-CSH288424H	4,023	C-CSH288424HF	4,137				
36	60	24	8	C-CSH366024H8	3,698	C-CSH366024HF8	3,868				
36	66	24	8	C-CSH366624H8	3,791	C-CSH366624HF8	3,962				
36	72	24	8	C-CSH367224H8	3,892	C-CSH367224HF8	4,053				
36	78	24	8	C-CSH367824H8	4,036	C-CSH367824HF8	4,191				
36	84	24	8	C-CSH368424H8	4,139	C-CSH368424HF8	4,284				
36	60	24	16	C-CSH366018H	3,599	C-CSH366018HF	3,776				
36	66	24	16	C-CSH366618H	3,683	C-CSH366618HF	3,860				
36	72	24	16	C-CSH367218H	3,772	C-CSH367218HF	3,946				
36	78	24	16	C-CSH367818H	3,913	C-CSH367818HF	4,074				
36	84	24	16	C-CSH368418H	4,005	C-CSH368418HF	4,161				

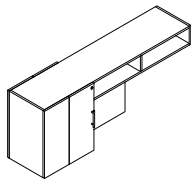

20 - 28" High Cantilevered

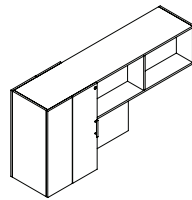

36" High Cantilevered

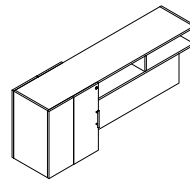

20 - 28" High Full Panel

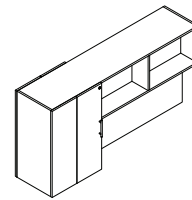

36" High Full Panel

Specify

- Laminate Selection for Case
- Laminate Selection for Door
- Choice of Handle

Notes

- Provides storage and space division facing two sides.
- 20" and 28" high unit has 8" high cubby above. 36" high unit has a 16" high cubby above.
- 60" - 72" wide units have (2) 12" wide lockable storage cabinets arranged in Yin-Yang configuration. 78" and 84" wide units have (2) 15 5/8" wide lockable storage cabinets arranged in Yin-Yang configuration.
- Doors on both sides are hinge left to open towards overhead/cantilevered side of hutch.
- Hutch can be ordered with a full width lower panel or with a cantilevered section that leaves 24 1/4" space (on all widths) for collaboration.
- Unit provided with rubber high friction strips for retention.
- **Important:** Maximum shelf weight 20 lbs per front and back.

SPINE HUTCH K (18" DEEP)

H	W	D	Model Number	List
28	36	18	C-CSH283618K	1,937
28	42	18	C-CSH284218K	2,010
28	48	18	C-CSH284818K	2,085
28	54	18	C-CSH285418K	2,533
28	60	18	C-CSH286018K	2,608
28	66	18	C-CSH286618K	2,689
28	72	18	C-CSH287218K	2,885
28	78	18	C-CSH287818K	2,960
28	84	18	C-CSH288418K	3,033
36	36	18	C-CSH373618K	2,054
36	42	18	C-CSH374218K	2,133
36	48	18	C-CSH374818K	2,211
36	54	18	C-CSH375418K	2,724
36	60	18	C-CSH376018K	2,803
36	66	18	C-CSH376618K	2,889
36	72	18	C-CSH377218K	3,093
36	78	18	C-CSH377818K	3,172
36	84	18	C-CSH378418K	3,249

SPINE HUTCH K (24" DEEP)

H	W	D	Model Number	List
28	36	24	C-CSH283624K	2,138
28	42	24	C-CSH284224K	2,232
28	48	24	C-CSH284824K	2,326
28	54	24	C-CSH285424K	2,851
28	60	24	C-CSH286024K	2,943
28	66	24	C-CSH286624K	3,044
28	72	24	C-CSH287224K	3,259
28	78	24	C-CSH287824K	3,354
28	84	24	C-CSH288424K	3,447
36	36	24	C-CSH373624K	2,285
36	42	24	C-CSH374224K	2,385
36	48	24	C-CSH374824K	2,480
36	54	24	C-CSH375424K	3,089
36	60	24	C-CSH376024K	3,186
36	66	24	C-CSH376624K	3,292
36	72	24	C-CSH377224K	3,515
36	78	24	C-CSH377824K	3,612
36	84	24	C-CSH378424K	3,710

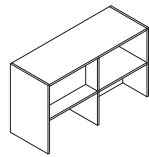

28" High

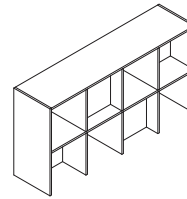

36" High

Specify

- Laminate Selection for Case
- Laminate Selection for Divider

Notes

- Provides storage and space division facing two sides.
- Shelves are arranged in Yin-Yang configuration alternating 4" and 12" deep and open.
- Units 48" wide and under have 2 columns of cubbies, units 54" wide and over have 4 columns of cubbies.

Spine Cabinet L

SPINE CABINET L (18" DEEP)					
H	W	D	Door Left	Door Right	List
			Model Number	Model Number	
20	24	18	C-CSC202418LL	C-CSC202418LR	1,942
20	30	18	C-CSC203018LL	C-CSC203018LR	2,067
20	36	18	C-CSC203618LL	C-CSC203618LR	2,259
20	42	18	C-CSC204218LL	C-CSC204218LR	2,385
20	48	18	C-CSC204818LL	C-CSC204818LR	2,508
28	24	18	C-CSC282418LL	C-CSC282418LR	2,186
28	30	18	C-CSC283018LL	C-CSC283018LR	2,333
28	36	18	C-CSC283618LL	C-CSC283618LR	2,548
28	42	18	C-CSC284218LL	C-CSC284218LR	2,693
28	48	18	C-CSC284818LL	C-CSC284818LR	2,841
36	24	18	C-CSC362418LL	C-CSC362418LR	2,433
36	30	18	C-CSC363018LL	C-CSC363018LR	2,601
36	36	18	C-CSC363618LL	C-CSC363618LR	2,835
36	42	18	C-CSC364218LL	C-CSC364218LR	3,002
36	48	18	C-CSC364818LL	C-CSC364818LR	3,172

SPINE CABINET L (24" DEEP)					
H	W	D	Door Left	Door Right	List
			Model Number	Model Number	
20	24	24	C-CSC202424LL	C-CSC202424LR	2,116
20	30	24	C-CSC203024LL	C-CSC203024LR	2,265
20	36	24	C-CSC203624LL	C-CSC203624LR	2,482
20	42	24	C-CSC204224LL	C-CSC204224LR	2,630
20	48	24	C-CSC204824LL	C-CSC204824LR	2,779
28	24	24	C-CSC282424LL	C-CSC282424LR	2,396
28	30	24	C-CSC283024LL	C-CSC283024LR	2,567
28	36	24	C-CSC283624LL	C-CSC283624LR	2,802
28	42	24	C-CSC284224LL	C-CSC284224LR	2,973
28	48	24	C-CSC284824LL	C-CSC284824LR	3,143
36	24	24	C-CSC362424LL	C-CSC362424LR	2,672
36	30	24	C-CSC363024LL	C-CSC363024LR	2,866
36	36	24	C-CSC363624LL	C-CSC363624LR	3,122
36	42	24	C-CSC364224LL	C-CSC364224LR	3,315
36	48	24	C-CSC364824LL	C-CSC364824LR	3,507

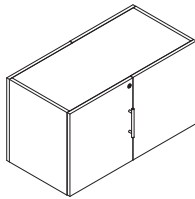

Door Left

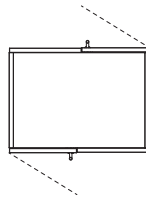

Door Left

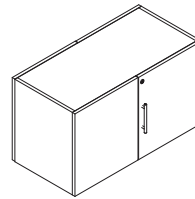

Door Right

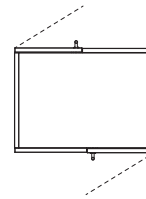

Door Right

Specify

- Laminate Selection for Case
- Laminate Selection for Door and Panel
- Choice of Handle

Notes

- Provides storage and space division facing two sides with lockable cabinet doors arranged in yin-yang configuration.
- "Door Left" Units have Left Hinge Doors. "Door Right" Units have Right Hinge Doors.
- Cabinets do not have shelves.
- Unit provided with rubber high friction strips for retention.
- Doors and panels can be ordered as HPL Whiteboard.

SPINE CABINET M (18" DEEP)					
H	W	D	Door Left		List
			Model Number	Model Number	
16	36	18	C-CSC163618ML	C-CSC163618MR	2,442
16	42	18	C-CSC164218ML	C-CSC164218MR	2,532
16	48	18	C-CSC164818ML	C-CSC164818MR	2,621
16	54	18	C-CSC165418ML	C-CSC165418MR	2,948
16	60	18	C-CSC166018ML	C-CSC166018MR	3,045
16	66	18	C-CSC166618ML	C-CSC166618MR	3,136
16	72	18	C-CSC167218ML	C-CSC167218MR	3,223
16	78	18	C-CSC167818ML	C-CSC167818MR	3,313
16	84	18	C-CSC168418ML	C-CSC168418MR	3,420
20	36	18	C-CSC203618ML	C-CSC203618MR	2,622
20	42	18	C-CSC204218ML	C-CSC204218MR	2,721
20	48	18	C-CSC204818ML	C-CSC204818MR	2,820
20	54	18	C-CSC205418ML	C-CSC205418MR	3,186
20	60	18	C-CSC206018ML	C-CSC206018MR	3,296
20	66	18	C-CSC206618ML	C-CSC206618MR	3,396
20	72	18	C-CSC207218ML	C-CSC207218MR	3,495
20	78	18	C-CSC207818ML	C-CSC207818MR	3,593
20	84	18	C-CSC208418ML	C-CSC208418MR	3,710

SPINE CABINET M (24" DEEP)					
H	W	D	Door Left		List
			Model Number	Model Number	
16	36	24	C-CSC163624ML	C-CSC163624MR	2,601
16	42	24	C-CSC164224ML	C-CSC164224MR	2,705
16	48	24	C-CSC164824ML	C-CSC164824MR	2,812
16	54	24	C-CSC165424ML	C-CSC165424MR	3,204
16	60	24	C-CSC166024ML	C-CSC166024MR	3,317
16	66	24	C-CSC166624ML	C-CSC166624MR	3,422
16	72	24	C-CSC167224ML	C-CSC167224MR	3,527
16	78	24	C-CSC167824ML	C-CSC167824MR	3,631
16	84	24	C-CSC168424ML	C-CSC168424MR	3,757
20	36	24	C-CSC203624ML	C-CSC203624MR	2,796
20	42	24	C-CSC204224ML	C-CSC204224MR	2,912
20	48	24	C-CSC204824ML	C-CSC204824MR	3,026
20	54	24	C-CSC205424ML	C-CSC205424MR	3,469
20	60	24	C-CSC206024ML	C-CSC206024MR	3,595
20	66	24	C-CSC206624ML	C-CSC206624MR	3,708
20	72	24	C-CSC207224ML	C-CSC207224MR	3,824
20	78	24	C-CSC207824ML	C-CSC207824MR	3,940
20	84	24	C-CSC208424ML	C-CSC208424MR	4,073

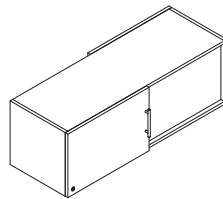

Door Left

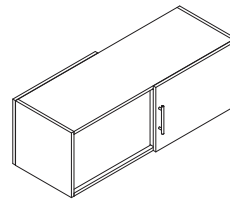

Door Right

Specify

- Laminate Selection for Case
- Laminate Selection for Divider
- Laminate Selection for Door
- Choice of Handle

Notes

- Provides storage and space division facing two sides with lockable sliding door.
- Cabinets do not have shelves.
- Unit provided with rubber high friction strips for retention.
- Yin-Yang Divider can be ordered as HPL Whiteboard. Divider is same color on both sides.

Spine Cabinet M

SPINE CABINET M (18" DEEP)					
H	W	D	Door Left	Door Right	List
			Model Number	Model Number	
28	36	18	C-CSC283618ML	C-CSC283618MR	2,942
28	42	18	C-CSC284218ML	C-CSC284218MR	3,061
28	48	18	C-CSC284818ML	C-CSC284818MR	3,247
28	54	18	C-CSC285418ML	C-CSC285418MR	3,572
28	60	18	C-CSC286018ML	C-CSC286018MR	3,702
28	66	18	C-CSC286618ML	C-CSC286618MR	3,822
28	72	18	C-CSC287218ML	C-CSC287218MR	3,944
28	78	18	C-CSC287818ML	C-CSC287818MR	4,063
28	84	18	C-CSC288418ML	C-CSC288418MR	4,203
36	36	18	C-CSC363618ML	C-CSC363618MR	3,260
36	42	18	C-CSC364218ML	C-CSC364218MR	3,401
36	48	18	C-CSC364818ML	C-CSC364818MR	3,672
36	54	18	C-CSC365418ML	C-CSC365418MR	3,958
36	60	18	C-CSC366018ML	C-CSC366018MR	4,107
36	66	18	C-CSC366618ML	C-CSC366618MR	4,248
36	72	18	C-CSC367218ML	C-CSC367218MR	4,394
36	78	18	C-CSC367818ML	C-CSC367818MR	4,534
36	84	18	C-CSC368418ML	C-CSC368418MR	4,694

SPINE CABINET M (24" DEEP)					
H	W	D	Door Left	Door Right	List
			Model Number	Model Number	
28	36	24	C-CSC283624ML	C-CSC283624MR	3,115
28	42	24	C-CSC284224ML	C-CSC284224MR	3,252
28	48	24	C-CSC284824ML	C-CSC284824MR	3,451
28	54	24	C-CSC285424ML	C-CSC285424MR	3,854
28	60	24	C-CSC286024ML	C-CSC286024MR	4,000
28	66	24	C-CSC286624ML	C-CSC286624MR	4,135
28	72	24	C-CSC287224ML	C-CSC287224MR	4,274
28	78	24	C-CSC287824ML	C-CSC287824MR	4,411
28	84	24	C-CSC288424ML	C-CSC288424MR	4,565
36	36	24	C-CSC363624ML	C-CSC363624MR	3,436
36	42	24	C-CSC364224ML	C-CSC364224MR	3,593
36	48	24	C-CSC364824ML	C-CSC364824MR	3,879
36	54	24	C-CSC365424ML	C-CSC365424MR	4,238
36	60	24	C-CSC366024ML	C-CSC366024MR	4,405
36	66	24	C-CSC366624ML	C-CSC366624MR	4,560
36	72	24	C-CSC367224ML	C-CSC367224MR	4,724
36	78	24	C-CSC367824ML	C-CSC367824MR	4,881
36	84	24	C-CSC368424ML	C-CSC368424MR	5,057

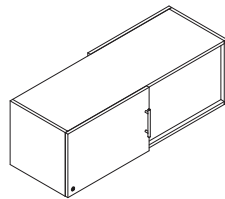

Door Left

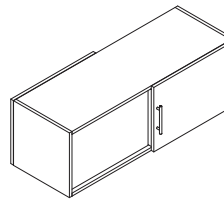

Door Right

Specify

- Laminate Selection for Case
- Laminate Selection for Divider
- Laminate Selection for Door
- Choice of Handle

Notes

- Provides storage and space division facing two sides with lockable sliding door.
- Cabinets do not have shelves.
- Unit provided with rubber high friction strips for retention.
- Yin-Yang Divider can be ordered as HPL Whiteboard. Divider is same color on both sides.

SPINE CABINET P (18" DEEP)					
H	W	D	Door Left		List
			Model Number	Model Number	
20	24	18	C-CSDC202418PL	C-CSDC202418PR	1,940
20	30	18	C-CSDC203018PL	C-CSDC203018PR	2,065
20	36	18	C-CSDC203618PL	C-CSDC203618PR	2,258
20	42	18	C-CSDC204218PL	C-CSDC204218PR	2,383
20	48	18	C-CSDC204818PL	C-CSDC204818PR	2,508
28	24	18	C-CSDC282418PL	C-CSDC282418PR	2,186
28	30	18	C-CSDC283018PL	C-CSDC283018PR	2,332
28	36	18	C-CSDC283618PL	C-CSDC283618PR	2,547
28	42	18	C-CSDC284218PL	C-CSDC284218PR	2,693
28	48	18	C-CSDC284818PL	C-CSDC284818PR	2,840
36	24	18	C-CSDC362418PL	C-CSDC362418PR	2,433
36	30	18	C-CSDC363018PL	C-CSDC363018PR	2,601
36	36	18	C-CSDC363618PL	C-CSDC363618PR	2,835
36	42	18	C-CSDC364218PL	C-CSDC364218PR	3,002
36	48	18	C-CSDC364818PL	C-CSDC364818PR	3,171

SPINE CABINET P (24" DEEP)					
H	W	D	Door Left		List
			Model Number	Model Number	
20	24	24	C-CSDC202424PL	C-CSDC202424PR	2,116
20	30	24	C-CSDC203024PL	C-CSDC203024PR	2,264
20	36	24	C-CSDC203624PL	C-CSDC203624PR	2,481
20	42	24	C-CSDC204224PL	C-CSDC204224PR	2,630
20	48	24	C-CSDC204824PL	C-CSDC204824PR	2,778
28	24	24	C-CSDC282424PL	C-CSDC282424PR	2,394
28	30	24	C-CSDC283024PL	C-CSDC283024PR	2,567
28	36	24	C-CSDC283624PL	C-CSDC283624PR	2,802
28	42	24	C-CSDC284224PL	C-CSDC284224PR	2,972
28	48	24	C-CSDC284824PL	C-CSDC284824PR	3,142
36	24	24	C-CSDC362424PL	C-CSDC362424PR	2,672
36	30	24	C-CSDC363024PL	C-CSDC363024PR	2,866
36	36	24	C-CSDC363624PL	C-CSDC363624PR	3,122
36	42	24	C-CSDC364224PL	C-CSDC364224PR	3,315
36	48	24	C-CSDC364824PL	C-CSDC364824PR	3,506

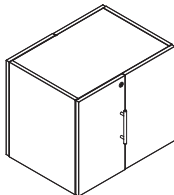

Door Left

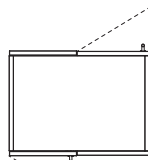

Door Left

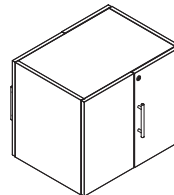

Door Right

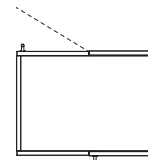

Door Right

Specify

- Laminate Selection for Case
- Laminate Selection for Door and Panel
- Choice of Handle

Notes

- Provides storage and space division facing two sides with lockable cabinet doors arranged in yin-yang configuration.
- "Door Left" Units have Left Hinge Doors. "Door Right" Units have Right Hinge Doors.
- Unit provided with rubber high friction strips for retention.
- Doors and panels can be ordered as HPL Whiteboard.

Spine Hutch R

SPINE HUTCH R (18" DEEP)							SPINE HUTCH R (24" DEEP)						
H	W	D	Inside H	Inside W	Model Number	List	H	W	D	Inside H	Inside W	Model Number	List
20	36	18	19.5	34.4	C-CSH203618R	1,776	20	36	24	19.5	34.4	C-CSH203624R	1,928
20	42	18	19.5	40.4	C-CSH204218R	1,858	20	42	24	19.5	40.4	C-CSH204224R	2,027
20	48	18	19.5	46.4	C-CSH204818R	2,019	20	48	24	19.5	46.4	C-CSH204824R	2,206
20	54	18	19.5	52.4	C-CSH205418R	2,101	20	54	24	19.5	52.4	C-CSH205424R	2,302
20	60	18	19.5	58.4	C-CSH206018R	2,182	20	60	24	19.5	58.4	C-CSH206024R	2,400
20	66	18	19.5	64.4	C-CSH206618R	2,346	20	66	24	19.5	64.4	C-CSH206624R	2,580
20	72	18	19.5	70.4	C-CSH207218R	2,426	20	72	24	19.5	70.4	C-CSH207224R	2,676
28	36	18	27.5	34.4	C-CSH283618R	1,922	28	36	24	27.5	34.4	C-CSH283624R	2,097
28	42	18	27.5	40.4	C-CSH284218R	2,015	28	42	24	27.5	40.4	C-CSH284224R	2,206
28	48	18	27.5	46.4	C-CSH284818R	2,190	28	48	24	27.5	46.4	C-CSH284824R	2,397
28	54	18	27.5	52.4	C-CSH285418R	2,285	28	54	24	27.5	52.4	C-CSH285424R	2,506
28	60	18	27.5	58.4	C-CSH286018R	2,378	28	60	24	27.5	58.4	C-CSH286024R	2,615
28	66	18	27.5	64.4	C-CSH286618R	2,550	28	66	24	27.5	64.4	C-CSH286624R	2,806
28	72	18	27.5	70.4	C-CSH287218R	2,644	28	72	24	27.5	70.4	C-CSH287224R	2,915
36	36	18	35.5	34.4	C-CSH363618R	2,211	36	36	24	35.5	34.4	C-CSH363624R	2,430
36	42	18	35.5	40.4	C-CSH364218R	2,330	36	42	24	35.5	40.4	C-CSH364224R	2,564
36	48	18	35.5	46.4	C-CSH364818R	2,528	36	48	24	35.5	46.4	C-CSH364824R	2,779
36	54	18	35.5	52.4	C-CSH365418R	2,649	36	54	24	35.5	52.4	C-CSH365424R	2,915
36	60	18	35.5	58.4	C-CSH366018R	2,765	36	60	24	35.5	58.4	C-CSH366024R	3,044
36	66	18	35.5	64.4	C-CSH366618R	2,961	36	66	24	35.5	64.4	C-CSH366624R	3,259
36	72	18	35.5	70.4	C-CSH367218R	3,084	36	72	24	35.5	70.4	C-CSH367224R	3,396

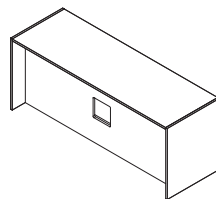

Specify

- Laminate Selection for Case
- Laminate Selection for Divider

Notes

- Always verify size of TV, including the dimensions, tilt, and offset of the TV wall mount.
- TV mounting not included.
- Includes kit to through bolt monitor stand with 1/4-20 x 1.5" fasteners.
- Includes kit to screw hutch to Calibrate Community spine.
- Compatible with Hutch A Tackboards.

SPINE HUTCH R (30" DEEP)

H	W	D	Inside H	Inside W	Model Number	List
20	36	30	19.5	34.4	C-CSH203630R	2,079
20	42	30	19.5	40.4	C-CSH204230R	2,195
20	48	30	19.5	46.4	C-CSH204830R	2,392
20	54	30	19.5	52.4	C-CSH205430R	2,503
20	60	30	19.5	58.4	C-CSH206030R	2,617
20	66	30	19.5	64.4	C-CSH206630R	2,813
20	72	30	19.5	70.4	C-CSH207230R	2,925
28	36	30	27.5	34.4	C-CSH283630R	2,271
28	42	30	27.5	40.4	C-CSH284230R	2,397
28	48	30	27.5	46.4	C-CSH284830R	2,603
28	54	30	27.5	52.4	C-CSH285430R	2,729
28	60	30	27.5	58.4	C-CSH286030R	2,854
28	66	30	27.5	64.4	C-CSH286630R	3,063
28	72	30	27.5	70.4	C-CSH287230R	3,186
36	36	30	35.5	34.4	C-CSH363630R	2,650
36	42	30	35.5	40.4	C-CSH364230R	2,800
36	48	30	35.5	46.4	C-CSH364830R	3,031
36	54	30	35.5	52.4	C-CSH365430R	3,184
36	60	30	35.5	58.4	C-CSH366030R	3,320
36	66	30	35.5	64.4	C-CSH366630R	3,558
36	72	30	35.5	70.4	C-CSH367230R	3,708

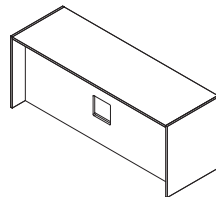

Specify

- Laminate Selection for Case
- Laminate Selection for Divider

Notes

- Always verify size of TV, including the dimensions, tilt, and offset of the TV wall mount.
- TV mounting not included.
- Includes kit to through bolt monitor stand with 1/4-20 x 1.5" fasteners.
- Includes kit to screw hutch to Calibrate Community spine.
- Compatible with Hutch A Tackboards.

Spine Hutch S

SPINE HUTCH S (18" DEEP)							SPINE HUTCH S (24" DEEP)						
H	W	D	Inside H	Inside W	Model Number	List	H	W	D	Inside H	Inside W	Model Number	List
20	36	18	19.5	34.4	C-CSH203618S	1,844	20	36	24	19.5	34.4	C-CSH203624S	2,003
20	42	18	19.5	40.4	C-CSH204218S	1,929	20	42	24	19.5	40.4	C-CSH204224S	2,104
20	48	18	19.5	46.4	C-CSH204818S	2,097	20	48	24	19.5	46.4	C-CSH204824S	2,290
20	54	18	19.5	52.4	C-CSH205418S	2,181	20	54	24	19.5	52.4	C-CSH205424S	2,391
20	60	18	19.5	58.4	C-CSH206018S	2,267	20	60	24	19.5	58.4	C-CSH206024S	2,492
20	66	18	19.5	64.4	C-CSH206618S	2,437	20	66	24	19.5	64.4	C-CSH206624S	2,679
20	72	18	19.5	70.4	C-CSH207218S	2,519	20	72	24	19.5	70.4	C-CSH207224S	2,779
28	36	18	27.5	34.4	C-CSH283618S	1,995	28	36	24	27.5	34.4	C-CSH283624S	2,177
28	42	18	27.5	40.4	C-CSH284218S	2,091	28	42	24	27.5	40.4	C-CSH284224S	2,290
28	48	18	27.5	46.4	C-CSH284818S	2,273	28	48	24	27.5	46.4	C-CSH284824S	2,489
28	54	18	27.5	52.4	C-CSH285418S	2,371	28	54	24	27.5	52.4	C-CSH285424S	2,602
28	60	18	27.5	58.4	C-CSH286018S	2,468	28	60	24	27.5	58.4	C-CSH286024S	2,716
28	66	18	27.5	64.4	C-CSH286618S	2,649	28	66	24	27.5	64.4	C-CSH286624S	2,914
28	72	18	27.5	70.4	C-CSH287218S	2,746	28	72	24	27.5	70.4	C-CSH287224S	3,028
36	36	18	35.5	34.4	C-CSH363618S	2,298	36	36	24	35.5	34.4	C-CSH363624S	2,524
36	42	18	35.5	40.4	C-CSH364218S	2,420	36	42	24	35.5	40.4	C-CSH364224S	2,664
36	48	18	35.5	46.4	C-CSH364818S	2,624	36	48	24	35.5	46.4	C-CSH364824S	2,885
36	54	18	35.5	52.4	C-CSH365418S	2,750	36	54	24	35.5	52.4	C-CSH365424S	3,028
36	60	18	35.5	58.4	C-CSH366018S	2,872	36	60	24	35.5	58.4	C-CSH366024S	3,159
36	66	18	35.5	64.4	C-CSH366618S	3,074	36	66	24	35.5	64.4	C-CSH366624S	3,384
36	72	18	35.5	70.4	C-CSH367218S	3,203	36	72	24	35.5	70.4	C-CSH367224S	3,527

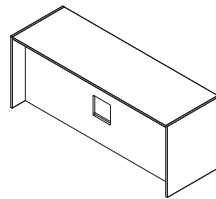

Specify

- Laminate Selection for Case
- Laminate Selection for Divider

Notes

- Always verify size of TV, including the dimensions, tilt, and offset of the TV wall mount.
- TV mounting not included.
- Includes kit to through bolt monitor stand with 1/4-20 x 1.5" fasteners.
- Includes kit to screw hutch to Calibrate Community spine.
- Compatible with Hutch A Tackboards.

SPINE HUTCH S (30" DEEP)

H	W	D	Inside H	Inside W	Model Number	List
20	36	30	19.5	34.4	C-CSH203630S	2,159
20	42	30	19.5	40.4	C-CSH204230S	2,278
20	48	30	19.5	46.4	C-CSH204830S	2,483
20	54	30	19.5	52.4	C-CSH205430S	2,599
20	60	30	19.5	58.4	C-CSH206030S	2,718
20	66	30	19.5	64.4	C-CSH206630S	2,922
20	72	30	19.5	70.4	C-CSH207230S	3,037
28	36	30	27.5	34.4	C-CSH283630S	2,358
28	42	30	27.5	40.4	C-CSH284230S	2,489
28	48	30	27.5	46.4	C-CSH284830S	2,704
28	54	30	27.5	52.4	C-CSH285430S	2,833
28	60	30	27.5	58.4	C-CSH286030S	2,964
28	66	30	27.5	64.4	C-CSH286630S	3,180
28	72	30	27.5	70.4	C-CSH287230S	3,310
36	36	30	35.5	34.4	C-CSH363630S	2,752
36	42	30	35.5	40.4	C-CSH364230S	2,907
36	48	30	35.5	46.4	C-CSH364830S	3,147
36	54	30	35.5	52.4	C-CSH365430S	3,306
36	60	30	35.5	58.4	C-CSH366030S	3,449
36	66	30	35.5	64.4	C-CSH366630S	3,694
36	72	30	35.5	70.4	C-CSH367230S	3,851

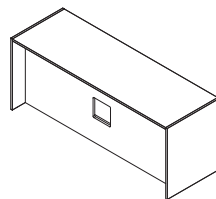

Specify

- Laminate Selection for Case
- Laminate Selection for Divider

Notes

- Always verify size of TV, including the dimensions, tilt, and offset of the TV wall mount.
- TV mounting not included.
- Includes kit to through bolt monitor stand with 1/4-20 x 1.5" fasteners.
- Includes kit to screw hutch to Calibrate Community spine.
- Compatible with Hutch A Tackboards.

13" High Floor Storage

13" HIGH STORAGE WITH SINGLE BOTTOM BOX DRAWER

H	W	D	Model Number	List
13	15	18	C-CLATF1815	1,481
13	18	18	C-CLATF1818	1,589
13	24	18	C-CLATF1824	1,698
13	30	18	C-CLATF1830	1,807
13	36	18	C-CLATF1836	1,916
13	42	18	C-CLATF1842	2,025
13	15	24	C-CLATF2415	1,592
13	18	24	C-CLATF2418	1,717
13	24	24	C-CLATF2424	1,841
13	30	24	C-CLATF2430	1,964
13	36	24	C-CLATF2436	2,087
13	42	24	C-CLATF2442	2,208

13" HIGH STORAGE WITH BOTTOM AND HIDDEN TOP BOX DRAWER

H	W	D	Model Number	List
13	15	18	C-CLATB1815	1,627
13	18	18	C-CLATB1818	1,748
13	24	18	C-CLATB1824	1,869
13	30	18	C-CLATB1830	1,988
13	36	18	C-CLATB1836	2,108
13	42	18	C-CLATB1842	2,227
13	15	24	C-CLATB2415	1,752
13	18	24	C-CLATB2418	1,887
13	24	24	C-CLATB2424	2,023
13	30	24	C-CLATB2430	2,160
13	36	24	C-CLATB2436	2,295
13	42	24	C-CLATB2442	2,428

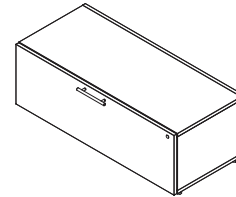
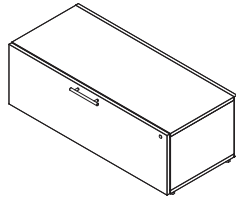

Specify

Notes

- | | |
|---|---|
| <ul style="list-style-type: none"> • Laminate Selection for Case • Laminate Selection for Face/Drawer • Choice of Handle | <ul style="list-style-type: none"> • 13" high storage can be used to support 21" high spines. • Single low bottom box drawer or with hidden top drawer as well. • Cannot accommodate filing. |
|---|---|

21" High BF Pedestals

BF PEDESTALS

H	W	D	Depth	Counterweight	Model Number	List
21	12	18	Full	Y	X-BFPFS182112	1,766
21	12	23	Partial	N	X-BFPFS232112	1,806
21	12	24	Full	Y	X-BFPFS242112	1,892
21	16	18	Full	Y	X-BFP18	1,962
21	16	23	Partial	N	X-BFP22C	2,008
21	16	24	Full	Y	X-BFP24	2,100
21	18	18	Full	Y	X-BFPFS182118	2,085
21	18	23	Partial	N	X-BFPFS232118	2,133
21	18	24	Full	Y	X-BFPFS242118	2,232
21	24	18	Full	Y	X-BFPFS182124	2,292
21	24	23	Partial	N	X-BFPFS232124	2,346
21	24	24	Full	Y	X-BFPFS242124	2,456

BF PEDESTALS ON FEET

H	W	D	Depth	Counterweight	Model Number	List
21	12	18	Full	Y	C-BFPFS182112	1,831
21	12	23	Partial	N	C-BFPFS232112	1,871
21	12	24	Full	Y	C-BFPFS242112	1,953
21	16	18	Full	Y	C-BFP18	2,031
21	16	23	Partial	N	C-BFP22	2,076
21	16	24	Full	Y	C-BFP24	2,170
21	18	18	Full	Y	C-BFPFS182118	2,159
21	18	23	Partial	N	C-BFPFS232118	2,208
21	18	24	Full	Y	C-BFPFS242118	2,307
21	24	18	Full	Y	C-BFPFS182124	2,373
21	24	23	Partial	N	C-BFPFS232124	2,428
21	24	24	Full	Y	C-BFPFS242124	2,537

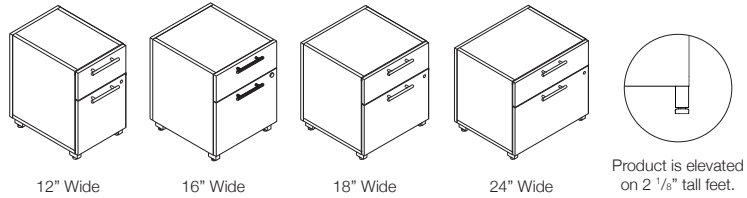
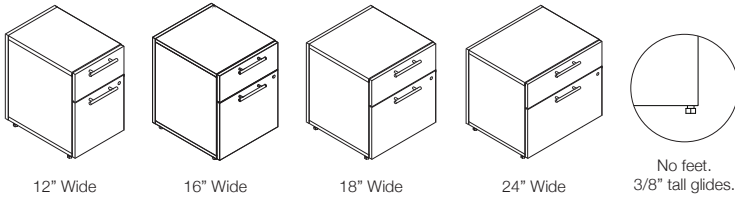

Specify

Notes

- Laminate Selection for Case
- Laminate Selection for Face/Drawer
- Choice of Handle

- 21" high storage can be used to support 29" high spines.

21" High Hidden Drawer BF Pedestals

HIDDEN DRAWER BF PEDESTALS

H	W	D	Depth	Counterweight	Model Number	List
21	12	18	Full	Y	X-BFPH211218	1,775
21	12	23	Partial	N	X-BFPH211223	1,814
21	12	24	Full	Y	X-BFPH211224	1,895
21	16	18	Full	Y	X-BFPH211618	1,969
21	16	23	Partial	N	X-BFPH211623	2,015
21	16	24	Full	Y	X-BFPH211624	2,105
21	18	18	Full	Y	X-BFPH211818	2,022
21	18	23	Partial	N	X-BFPH211823	2,069
21	18	24	Full	Y	X-BFPH211824	2,166

HIDDEN DRAWER BF PEDESTALS ON FEET

H	W	D	Depth	Counterweight	Model Number	List
21	12	18	Full	Y	C-BFPHD211218	1,714
21	12	23	Partial	N	C-BFPHD211223	1,752
21	12	24	Full	Y	C-BFPHD211224	1,832
21	16	18	Full	Y	C-BFPHD211618	1,903
21	16	23	Partial	N	C-BFPHD211623	1,948
21	16	24	Full	Y	C-BFPHD211624	2,037
21	18	18	Full	Y	C-BFPHD211818	2,095
21	18	23	Partial	N	C-BFPHD211823	2,141
21	18	24	Full	Y	C-BFPHD211824	2,238

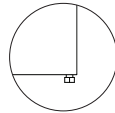
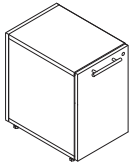

No feet.
3/8" tall glides.

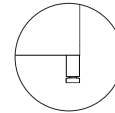
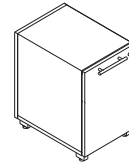

Product is elevated
on 2 1/8" tall feet.

Specify

- Laminate Selection for Case
- Laminate Selection for Face/Drawer
- Handle Selection

Notes

- 21" high storage can be used to support 29" high spines.

21" High Lateral Floor Storage

BF LATERALS

H	W	D	Depth	Counterweight	Model Number	List
21	30	18	Full	Y	X-PLAT2D3018	2,575
21	36	18	Full	Y	X-PLAT2D3618	2,719
21	42	18	Full	Y	X-PLAT2D4218	2,860
21	30	22	Partial*	N	X-PLAT2D3022C	2,684
21	36	22	Partial*	N	X-PLAT2D3622C	2,834
21	42	22	Partial*	N	X-PLAT2D4222C	2,986
21	30	24	Full	Y	X-PLAT2D3024	2,770
21	36	24	Full	Y	X-PLAT2D3624	2,931
21	42	24	Full	Y	X-PLAT2D4224	3,089

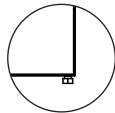
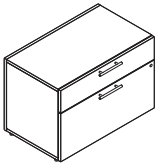

No feet.
3/8" tall glides.

BF LATERALS ON FEET

H	W	D	Depth	Counterweight	Model Number	List
21	30	18	Full	Y	C-PLATJ2D30	2,645
21	36	18	Full	Y	C-PLATJ2D36	2,789
21	42	18	Full	Y	C-PLATJ2D42	2,931
21	30	22	Partial*	N	C-PLAT2D3022	2,753
21	36	22	Partial*	N	C-PLAT2D3622	2,904
21	42	22	Partial*	N	C-PLAT2D4222	3,055
21	30	24	Full	Y	C-PLAT2D3024	2,841
21	36	24	Full	Y	C-PLAT2D3624	2,999
21	42	24	Full	Y	C-PLAT2D4224	3,159

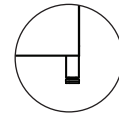
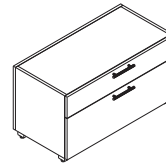

Product is elevated
on 2 1/8" tall feet.

Specify

- Laminate Selection for Case
- Laminate Selection for Face/Drawer
- Choice of Handle

Notes

- 21" high storage can be used to support 29" high spines.

21" High Floor Bookcases

FLOOR BOOKCASES				
H	W	D	Model Number	List
21	24	14	X-BC202414	1,379
21	30	14	X-BC203014	1,433
21	36	14	X-BC203614	1,660
21	42	14	X-BC204214	1,710
21	48	14	X-BC204814	1,767
21	54	14	X-BC205414	2,110
21	60	14	X-BC206014	2,167
21	66	14	X-BC206614	2,219
21	72	14	X-BC207214	2,270
21	24	18	X-CBC2024	1,399
21	30	18	X-CBC2030	1,466
21	36	18	X-CBC2036	1,718
21	42	18	X-CBC2042	1,778
21	48	18	X-CBC2048	1,845
21	54	18	X-CBC2054	2,166
21	60	18	X-CBC2060	2,227
21	66	18	X-CBC2066	2,295
21	72	18	X-CBC2072	2,358
21	24	24	X-CBC202424	1,399
21	30	24	X-CBC203024	1,449
21	36	24	X-CBC203624	1,716
21	42	24	X-CBC204224	1,784
21	48	24	X-CBC204824	1,845
21	54	24	X-CBC205424	2,143
21	60	24	X-CBC206024	2,211
21	66	24	X-CBC206624	2,290
21	72	24	X-CBC207224	2,361

FLOOR BOOKCASES ON FEET				
H	W	D	Model Number	List
21	24	14	C-BC202414	1,448
21	30	14	C-BC203014	1,504
21	36	14	C-BC203614	1,728
21	42	14	C-BC204214	1,780
21	48	14	C-BC204814	1,838
21	54	14	C-BC205414	2,180
21	60	14	C-BC206014	2,236
21	66	14	C-BC206614	2,290
21	72	14	C-BC207214	2,339
21	24	18	C-BC202418	1,470
21	30	18	C-BC203018	1,536
21	36	18	C-BC203618	1,787
21	42	18	C-BC204218	1,848
21	48	18	C-BC204818	1,915
21	54	18	C-BC205418	2,235
21	60	18	C-BC206018	2,298
21	66	18	C-BC206618	2,366
21	72	18	C-BC207218	2,428
21	24	24	C-BC202424	1,440
21	30	24	C-BC203024	1,516
21	36	24	C-BC203624	1,780
21	42	24	C-BC204224	1,852
21	48	24	C-BC204824	1,925
21	54	24	C-BC205424	2,208
21	60	24	C-BC206024	2,280
21	66	24	C-BC206624	2,358
21	72	24	C-BC207224	2,429

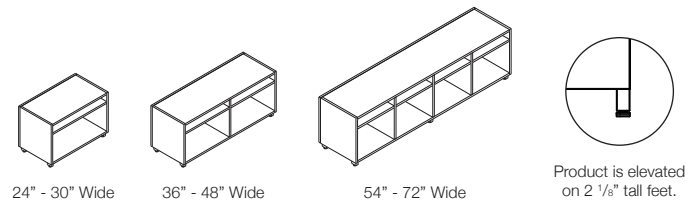
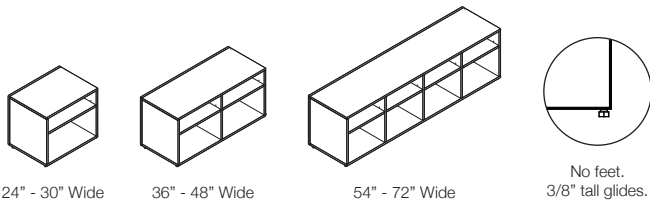

Specify

Notes

• Laminate Selection for Unit

• 21" high storage can be used to support 29" high spines.

21" High Shared Floor Bookcases

SHARED FLOOR BOOKCASES

H	W	D	Open Left	Open Right	List
			Model Number	Model Number	
21	36	18	X-CBCSL213618	X-CBCSR213618	1,736
21	42	18	X-CBCSL214218	X-CBCSR214218	1,798
21	48	18	X-CBCSL214818	X-CBCSR214818	1,857
21	54	18	X-CBCSL215418	X-CBCSR215418	2,179
21	60	18	X-CBCSL216018	X-CBCSR216018	2,248
21	66	18	X-CBCSL216618	X-CBCSR216618	2,311
21	72	18	X-CBCSL217218	X-CBCSR217218	2,371

SHARED FLOOR BOOKCASES ON FEET

H	W	D	Open Left	Open Right	List
			Model Number	Model Number	
21	36	18	C-YFBCL2036	C-YFBCR2036	1,805
21	42	18	C-YFBCL2042	C-YFBCR2042	1,868
21	48	18	C-YFBCL2048	C-YFBCR2048	1,928
21	54	18	C-CBCSL215418	C-CBCSR215418	2,249
21	60	18	C-YFBCL2060	C-YFBCR2060	2,319
21	66	18	C-YFBCL2066	C-YFBCR2066	2,380
21	72	18	C-YFBCL2072	C-YFBCR2072	2,441

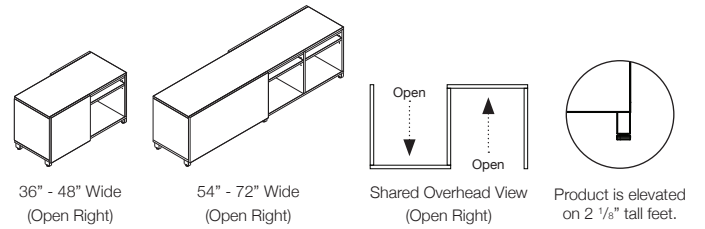
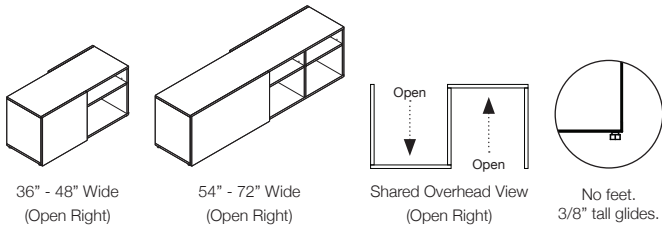

Specify

- Laminate Selection for Case
- Laminate Selection for Face

Notes

- 21" high storage can be used to support 29" high spines.

21" High Floor Cabinets

TWO DOOR CABINETS

H	W	D	Model Number	List
21	24	18	X-CCD2024	1,805
21	30	18	X-CCD2030	1,885
21	36	18	X-CCD2036	2,030
21	42	18	X-CCD2042	2,106
21	48	18	X-CCD2048	2,190

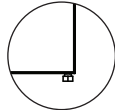
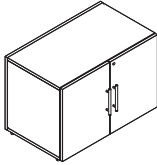

No feet.
3/8" tall glides.

TWO DOOR CABINETS ON FEET

H	W	D	Model Number	List
21	24	18	C-CC202418L	1,875
21	30	18	C-CC203018L	1,955
21	36	18	C-CC203618L	2,100
21	42	18	C-CC204218L	2,177
21	48	18	C-CC204818L	2,260

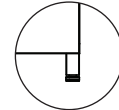
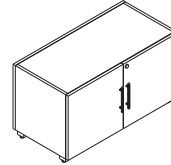

Product is elevated
on 2 1/8" tall feet.

FOUR DOOR CABINETS

H	W	D	Model Number	List
21	54	18	X-CCD2054	2,669
21	60	18	X-CCD2060	2,750
21	66	18	X-CCD2066	2,830
21	72	18	X-CCD2072	2,910

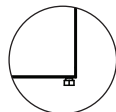
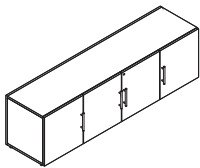

No feet.
3/8" tall glides.

FOUR DOOR CABINETS ON FEET

H	W	D	Model Number	List
21	54	18	C-CC205418L	2,739
21	60	18	C-CC206018L	2,820
21	66	18	C-CC206618L	2,900
21	72	18	C-CC207218L	2,978

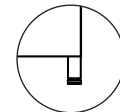
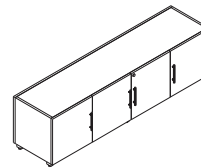

Product is elevated
on 2 1/8" tall feet.

Specify

- Laminate Selection for Case
- Laminate Selection for Door/Face
- Choice of Handle

Notes

- 21" high storage can be used to support 29" high spines.
- On four door cabinets only the center doors are lockable.

21" High Floor Credenzas

CREDENZAS WITH SLIDING DOORS

H	W	D	Left-Side Lock	Right-Side Lock	List
			Model Number	Model Number	
21	30	18	X-CSDL2030	X-CSDR2030	2,018
21	36	18	X-CSDL2036	X-CSDR2036	2,073
21	42	18	X-CSDL2042	X-CSDR2042	2,129
21	48	18	X-CSDL2048	X-CSDR2048	2,189
21	54	18	X-CSDL2054	X-CSDR2054	2,488
21	60	18	X-CSDL2060	X-CSDR2060	2,549
21	66	18	X-CSDL2066	X-CSDR2066	2,604
21	72	18	X-CSDL2072	X-CSDR2072	2,661

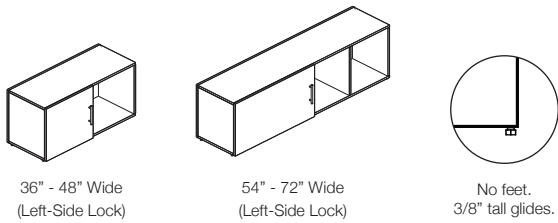

CREDENZAS WITH SLIDING DOORS ON FEET

H	W	D	Left-Side Lock	Right-Side Lock	List
			Model Number	Model Number	
21	30	18	C-CS203018LL	C-CS203018RL	2,087
21	36	18	C-CS203618LL	C-CS203618RL	2,143
21	42	18	C-CS204218LL	C-CS204218RL	2,198
21	48	18	C-CS204818LL	C-CS204818RL	2,259
21	54	18	C-CS205418LL	C-CS205418RL	2,558
21	60	18	C-CS206018LL	C-CS206018RL	2,619
21	66	18	C-CS206618LL	C-CS206618RL	2,673
21	72	18	C-CS207218LL	C-CS207218RL	2,730

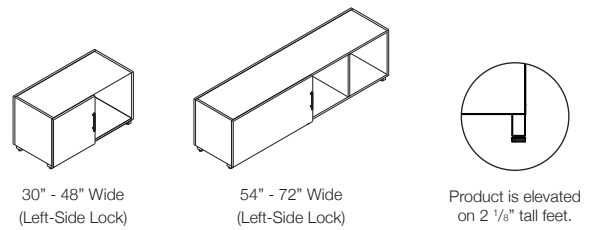

SHARED CREDENZAS WITH SLIDING DOORS

H	W	D	Left-Side Lock	Right-Side Lock	List
			Model Number	Model Number	
21	36	18	X-CBCSDSL211836	X-CBCSDSR211836	2,796
21	42	18	X-CBCSDSL211842	X-CBCSDSR211842	2,875
21	48	18	X-CBCSDSL211848	X-CBCSDSR211848	2,951
21	54	18	X-CBCSDSL211854	X-CBCSDSR211854	3,127
21	60	18	X-CBCSDSL211860	X-CBCSDSR211860	3,220
21	66	18	X-CBCSDSL211866	X-CBCSDSR211866	3,293
21	72	18	X-CBCSDSL211872	X-CBCSDSR211872	3,368

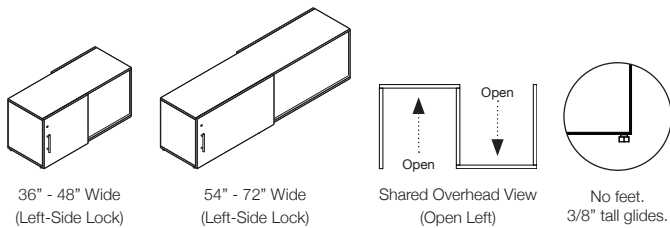

SHARED CREDENZAS WITH SLIDING DOORS ON FEET

H	W	D	Left-Side Lock	Right-Side Lock	List
			Model Number	Model Number	
21	36	18	C-YFBCSDL2036	C-YFBCSDR2036	2,865
21	42	18	C-YFBCSDL2042	C-YFBCSDR2042	2,946
21	48	18	C-YFBCSDL2048	C-YFBCSDR2048	3,021
21	54	18	C-CBCSDSL211854	C-CBCSDSR211854	3,197
21	60	18	C-YFBCSDL2060	C-YFBCSDR2060	3,290
21	66	18	C-YFBCSDL2066	C-YFBCSDR2066	3,365
21	72	18	C-YFBCSDL2072	C-YFBCSDR2072	3,438

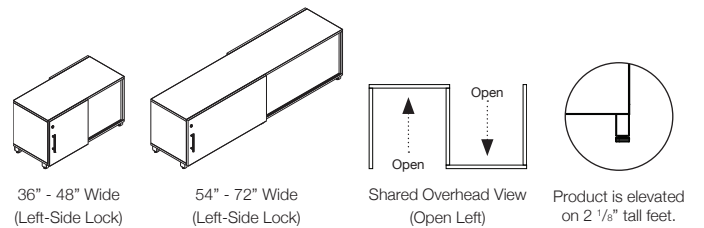

Specify

- Laminate Selection for Case
- Laminate Selection for Doors/Face
- Choice of Handle

Notes

- 21" high storage can be used to support 29" high spines.

21" High Combo Units with BF Pedestal and Bookcase

COMBO UNITS WITH BF PEDESTAL AND BOOKCASE

H	W	D	Bookcase Left		List
			Model Number	Model Number	
21	30	18	X-BFCBCR213018	X-BFCBCL213018	2,249
21	36	18	X-BFCBCR213618	X-BFCBCL213618	2,385
21	42	18	X-BFCBCR214218	X-BFCBCL214218	2,520
21	48	18	X-BFCBCR214818	X-BFCBCL214818	2,588
21	54	18	X-BFCBCR215418	X-BFCBCL215418	3,136
21	60	18	X-BFCBCR216018	X-BFCBCL216018	3,203
21	66	18	X-BFCBCR216618	X-BFCBCL216618	3,451
21	72	18	X-BFCBCR217218	X-BFCBCL217218	3,515
21	30	24	X-BFCBCR213024	X-BFCBCL213024	2,408
21	36	24	X-BFCBCR213624	X-BFCBCL213624	2,544
21	42	24	X-BFCBCR214224	X-BFCBCL214224	2,680
21	48	24	X-BFCBCR214824	X-BFCBCL214824	2,753
21	54	24	X-BFCBCR215424	X-BFCBCL215424	3,350
21	60	24	X-BFCBCR216024	X-BFCBCL216024	3,422
21	66	24	X-BFCBCR216624	X-BFCBCL216624	3,674
21	72	24	X-BFCBCR217224	X-BFCBCL217224	3,737

COMBO UNITS WITH BF PEDESTAL AND BOOKCASE ON FEET

H	W	D	Bookcase Left		List
			Model Number	Model Number	
21	30	18	C-BFCBCR213018	C-BFCBCL213018	2,391
21	36	18	C-BFCBCR213618	C-BFCBCL213618	2,523
21	42	18	C-BFCBCR214218	C-BFCBCL214218	2,661
21	48	18	C-BFCBCR214818	C-BFCBCL214818	2,796
21	54	18	C-BFCBCR215418	C-BFCBCL215418	3,275
21	60	18	C-BFCBCR216018	C-BFCBCL216018	3,340
21	66	18	C-BFCBCR216618	C-BFCBCL216618	3,593
21	72	18	C-BFCBCR217218	C-BFCBCL217218	3,653
21	30	24	C-BFCBCR213024	C-BFCBCL213024	2,478
21	36	24	C-BFCBCR213624	C-BFCBCL213624	2,614
21	42	24	C-BFCBCR214224	C-BFCBCL214224	2,749
21	48	24	C-BFCBCR214824	C-BFCBCL214824	2,893
21	54	24	C-BFCBCR215424	C-BFCBCL215424	3,488
21	60	24	C-BFCBCR216024	C-BFCBCL216024	3,562
21	66	24	C-BFCBCR216624	C-BFCBCL216624	3,814
21	72	24	C-BFCBCR217224	C-BFCBCL217224	3,876

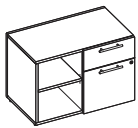

36" - 48" Wide
(Bookcase Left)

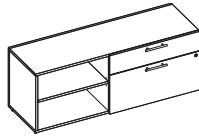

54" - 72" Wide
(Bookcase Left)

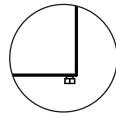

No feet.
3/8" tall glides.

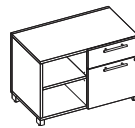

36" - 48" Wide
(Bookcase Left)

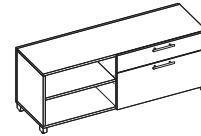

54" - 72" Wide
(Bookcase Left)

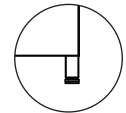

Product is elevated
on 2 1/8" tall feet.

Specify

Notes

- Laminate Selection for Case
- Laminate Selection for Drawers/Face
- Choice of Handle

- On sizes 36" - 48" wide, pedestal width is 15.78 wide. On sizes 54" - 72" wide, drawer width is 30" wide.
- 21" high storage can be used to support 29" high spines.

Electrical Jumpers

ELECTRICAL JUMPERS

Actual L	Model Number	List
18	E-MX8W4PTPC18	212
21	E-MX8W4PTPC21	222
24	E-UN8W4VT16	260
30	E-UN8W4J30	276
33	E-HM8W4PJ24	277
37	E-MW8W4PJ18	272
39	E-HM8W4PJ30	277
43	E-MW8W4PJ24	303
45	E-MW8W4PJ24E	315
48	E-UN8W4J48	276
49	E-MW8W4PJ30	324
51	E-MW8W4PJ30E	331
55	E-MW8W4PJ36	334
57	E-MW8W4PJ36E	342
61	E-MW8W4PJ42	345
63	E-MW8W4PJ42E	351
67	E-MW8W4PJ48	372
69	E-MW8W4PJ48E	382
79	E-MW8W4PJ60	400
81	E-MW8W4PJ60E	421
86	E-MW8W4PJ86	458

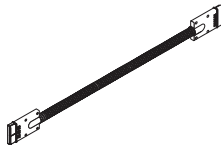

Calibrate Community Jumper Specification Grid:
Jumper length when joining powered spine beams together.

Spine Width	To 36"	To 42"	To 48"	To 54"	To 60"	To 66"	To 72"	To 78"	To 84"	To 90"	To 96"
From 36"	24	30	33	33	37	37	43	43	48	51	55
From 42"	30	30	33	37	39	43	43	48	51	55	57
From 48"	33	33	37	39	43	43	48	51	55	57	61
From 54"	33	37	39	43	43	48	51	55	57	61	63
From 60"	37	39	43	43	48	51	55	57	61	63	67
From 66"	37	43	43	48	51	55	57	61	63	67	69
From 72"	43	43	48	51	55	57	61	63	67	69	79
From 78"	43	48	51	55	57	61	63	67	69	79	79
From 84"	48	51	55	57	61	63	67	69	69	79	79
from 90"	51	55	57	61	63	67	69	79	79	79	79
From 96"	55	57	61	63	67	69	79	79	79	79	86

Notes

- Electrical jumpers connect powered spines.
- Electrical jumpers are listed in actual lengths to assist with specification. Jumper use is explained in the chart on this page.
- Single and Double Sided Spines require connecting on one side of spine only.
- **Important:** Certain areas of Chicago prohibit the use of modular electrical systems and require all electrical components to be hard wired. All electrical components need to be supplied by the electrician.

Outlets

DUPLEX OUTLETS

Line	Color	Model Number	List
1	Black	E-MW8W4DO1	78
2	Black	E-MW8W4DO2	78
3	Black	E-MW8W4DO3	78
4	Black	E-MW8W4DO4	78
1	White	E-MW8W4DO1-W	78
2	White	E-MW8W4DO2-W	78
3	White	E-MW8W4DO3-W	78
4	White	E-MW8W4DO4-W	78

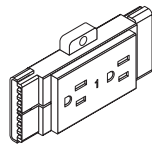

CALIFORNIA TITLE 24 CONTROLLED DUPLEX OUTLETS

Line	Color	Model Number	List
1	Black	E-MW8W4T24DO1	90
2	Black	E-MW8W4T24DO2	90
3	Black	E-MW8W4T24DO3	90
4	Black	E-MW8W4T24DO4	90
1	White	E-MW8W4T24DO1-W	90
2	White	E-MW8W4T24DO2-W	90
3	White	E-MW8W4T24DO3-W	90
4	White	E-MW8W4T24DO4-W	90

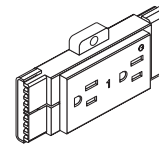

Notes

- Duplex Outlets are available at designated circuits 1 through 4.
- Each duplex outlet contains two single receptacles (places to plug into) of the same circuit and are specified separately from powerways.
- Available in black or white. The lettering on outlets for Circuit 1, 2 and 3 is white. The lettering on outlets for Circuit 4 is orange.
- Outlets are screw mounted to powerway.
- Duplex outlets are standard 15 amp outlets.
- Can be used with multi-circuit electrical units.

Notes

- In California, 50 percent of all outlets in a systems panel cluster or benching cluster, for new construction, MUST be controlled outlets, even if there is no task lighting.
- Customers should plan on using circuits 2 and 3 for controlled circuits, and plan general load for all other items on circuits 1 and 4.
- If using 2 + 2 configuration, controlled circuits should be 1 and 2, and general load circuits on 4 and 5.
- Outlets must have the “controlled” symbol for identification purposes.
- Can be used with multi-circuit electrical units.

USB OUTLETS

Line	Color	Model Number	List
1	Black	E-UN8W4USB01	317
2	Black	E-UN8W4USB02	317
3	Black	E-UN8W4USB03	317
4	Black	E-UN8W4USB04	317
1	White	E-UN8W4USB01-W	283
2	White	E-UN8W4USB02-W	283
3	White	E-UN8W4USB03-W	283
4	White	E-UN8W4USB04-W	283

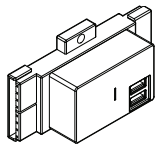

Notes

- USB Outlets bring charging options to panel power distribution systems.
- The USB Outlets provide convenient charging power access through dual ports on the face of the receptacle.
- The USB Outlets offer a total of 2 Amps between two USB charging ports.
- The USB Outlets are UL and FCC Part 15A approved.
- Can be used with multi-circuit electrical units.

DUPLEX OUTLET HOLE COVERS

Model Number	List
E-UNWC	30

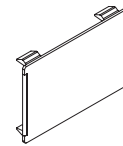

Specify

- Paint Selection for Hole Cover

Notes

- Duplex Outlet Hole Covers are supplied with each powered panel to cover unused duplex outlet locations (six).
- 24"W panels only include three duplex outlet hole covers.
- Order extra hole covers separately only when required.
- Can be used with multi-circuit electrical units.

Data Plate Kits

DATA PLATE KIT

Item	Model Number	List
6 Port Data Gang Plate	E-HDP6B-SM	34
CAT 5e Jack	E-HRJ45-SM	123
CAT 6 Data Jack	E-HXJ6BK-SM	134
Hole Blank (10 Pack)	E-SFBB10-SM	83

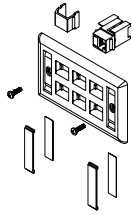

Notes

- Single Data Plate Kit has six ports for modular jacks.
- Bezel screws directly to the access box in pre-drilled and tapped hole pattern.
- RJ-45 jacks can be used in place of RJ-11 jacks.

SINGLE GANG PLATE ADAPTER

Model Number	List
E-DJA	47

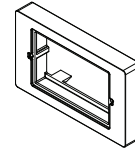

Notes

- Single Gang Plate Adapter (1) provided with each access box to adapt single gang plates to box.
- Single gang plates cannot be used with “grommet only” option.

Infeeds for Infeed Base Supports

SIDE-MOUNTED BASE INFEEDS

Actual L	Use	Model Number	List
72"	Standard	E-UN8W4BIFS	493
72"	New York City	E-HM8W4BIFSNY	980

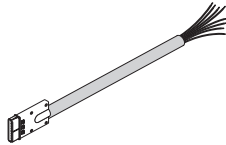

Notes

- Side-mounted base infeeds provide interface with building power at the end of the power units and mounts to the powerway at jumper location.
- Each base infeed is 6' in length, encased in "liquid tight".
- New York City code requires the use of a special base feed with an in-line junction box.

CEILING INFEED

Actual L	Model Number	List
144"	E-UN8W4CIF	577

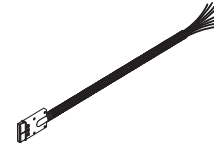

Notes

- Ceiling infeeds provide interface with building power from a suspended ceiling through a power pole shell.
- Each ceiling feed is 12' long.
- Power pole shells are ordered separately.

END MOUNT POLE

Type	Model Number	List	Grade C Paint
For 21 High	T-BEMP21	1,411	+25
For 29 High	T-BEMP29	1,411	+25



Specify

Notes

- Paint Selection
- End mount poles are used for concealing ceiling infeeds or data cables from a max 11'6" standard suspended ceiling.
- Choose pole that corresponds to the spine height.
- Order ceiling feed separately.
- Poles must be attached to ceiling grids at time of installation and will not support pole alone.
- Poles require cutting standard round 2 3/4" grommet in end panels.

Tackboards for Spine Hutch A

PET TACKBOARD FOR SPINE HUTCH A

H	W	Model Number	List
12	24	C-CTACK1224A	366
12	30	C-CTACK1230A	385
12	36	C-CTACK1236A	403
12	42	C-CTACK1242A	442
12	48	C-CTACK1248A	462
12	54	C-CTACK1254A	480
12	60	C-CTACK1260A	501
12	66	C-CTACK1266A	518
12	72	C-CTACK1272A	537
16	24	C-CTACK1624A	385
16	30	C-CTACK1630A	423
16	36	C-CTACK1636A	442
16	42	C-CTACK1642A	462
16	48	C-CTACK1648A	480
16	54	C-CTACK1654A	518
16	60	C-CTACK1660A	537
16	66	C-CTACK1666A	557
16	72	C-CTACK1672A	576
20	24	C-CTACK2024A	403
20	30	C-CTACK2030A	442
20	36	C-CTACK2036A	462
20	42	C-CTACK2042A	501
20	48	C-CTACK2048A	518
20	54	C-CTACK2054A	537
20	60	C-CTACK2060A	576
20	66	C-CTACK2066A	594
20	72	C-CTACK2072A	634

FABRIC TACKBOARD FOR SPINE HUTCH A

H	W	Model Number	List	Fabric Grade C	Fabric Grade D
12	24	C-CTACKF1224A	720	+11	+23
12	30	C-CTACKF1230A	728	+11	+23
12	36	C-CTACKF1236A	736	+11	+23
12	42	C-CTACKF1242A	745	+11	+23
12	48	C-CTACKF1248A	764	+11	+23
12	54	C-CTACKF1254A	783	+11	+23
12	60	C-CTACKF1260A	804	+11	+23
12	66	C-CTACKF1266A	789	+11	+23
12	72	C-CTACKF1272A	805	+11	+23
16	24	C-CTACKF1624A	739	+17	+37
16	30	C-CTACKF1630A	749	+17	+37
16	36	C-CTACKF1636A	760	+17	+37
16	42	C-CTACKF1642A	769	+17	+37
16	48	C-CTACKF1648A	788	+17	+37
16	54	C-CTACKF1654A	805	+17	+37
16	60	C-CTACKF1660A	823	+17	+37
16	66	C-CTACKF1666A	850	+17	+37
16	72	C-CTACKF1672A	870	+17	+37
20	24	C-CTACKF2024A	760	+23	+50
20	30	C-CTACKF2030A	771	+23	+50
20	36	C-CTACKF2036A	783	+23	+50
20	42	C-CTACKF2042A	795	+23	+50
20	48	C-CTACKF2048A	814	+23	+50
20	54	C-CTACKF2054A	835	+23	+50
20	60	C-CTACKF2060A	855	+23	+50
20	66	C-CTACKF2066A	875	+23	+50
20	72	C-CTACKF2072A	898	+23	+50

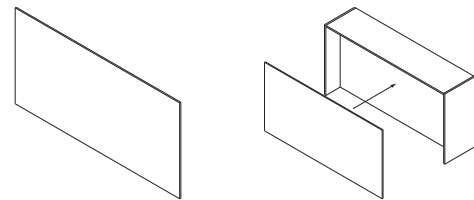
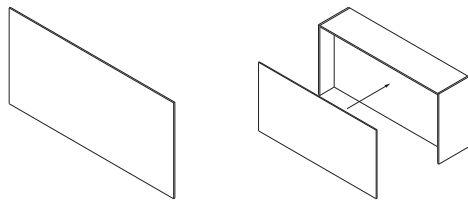

Specify

- Color Selection for PET- Lite Grey, Medium Grey, Tan or Vibrant Blue

Notes

- Match each tackboard to its specific hutch using height, width and style dimensions.
- On PET tackboards, tack holes may remain visible after tacks have been removed.

Specify

- Fabric Selection

Notes

- Match each tackboard to its specific hutch using height, width and style dimensions.
- Tackboard fabric direction is vertical on 24" to 48" wide units and will run horizontally for 54" to 96" wide pieces.

Tackboards for Spine Hutch A

PET TACKBOARD FOR SPINE HUTCH A

H	W	Model Number	List
28	24	C-CTACK2824A	442
28	30	C-CTACK2830A	480
28	36	C-CTACK2836A	518
28	42	C-CTACK2842A	557
28	48	C-CTACK2848A	576
28	54	C-CTACK2854A	614
28	60	C-CTACK2860A	652
28	66	C-CTACK2866A	692
28	72	C-CTACK2872A	710
36	24	C-CTACK3624A	480
36	30	C-CTACK3630A	537
36	36	C-CTACK3636A	576
36	42	C-CTACK3642A	614
36	48	C-CTACK3648A	652
36	54	C-CTACK3654A	692
36	60	C-CTACK3660A	728
36	66	C-CTACK3666A	767
36	72	C-CTACK3672A	805

FABRIC TACKBOARD FOR SPINE HUTCH A

H	W	Model Number	List	Fabric Grade C	Fabric Grade D
28	24	C-CTACKF2824A	801	+34	+73
28	30	C-CTACKF2830A	815	+34	+73
28	36	C-CTACKF2836A	830	+34	+73
28	42	C-CTACKF2842A	844	+34	+73
28	48	C-CTACKF2848A	861	+34	+73
28	54	C-CTACKF2854A	876	+34	+73
28	60	C-CTACKF2860A	891	+34	+73
28	66	C-CTACKF2866A	997	+34	+73
28	72	C-CTACKF2872A	1,029	+34	+73
36	24	C-CTACKF3624A	840	+46	+100
36	30	C-CTACKF3630A	859	+46	+100
36	36	C-CTACKF3636A	876	+46	+100
36	42	C-CTACKF3642A	896	+46	+100
36	48	C-CTACKF3648A	916	+46	+100
36	54	C-CTACKF3654A	938	+46	+100
36	60	C-CTACKF3660A	956	+46	+100
36	66	C-CTACKF3666A	1,049	+46	+100
36	72	C-CTACKF3672A	1,083	+46	+100

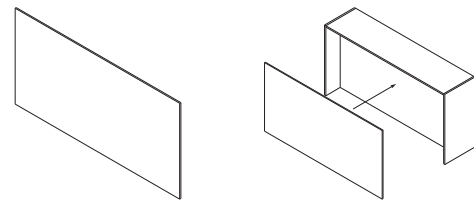
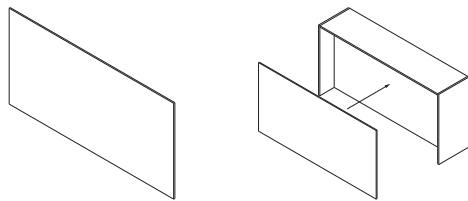

Specify **Notes**

- Color Selection for PET- Lite Grey, Medium Grey, Tan or Vibrant Blue
- Match each tackboard to it's specific hutch using height, width and style dimensions.
- On PET tackboards, tack holes may remain visible after tacks have been removed.

Specify **Notes**

- Fabric Selection
- Match each tackboard to it's specific hutch using height, width and style dimensions.
- Tackboard fabric direction is vertical on 24" to 48" wide units and will run horizontally for 54" to 96" wide pieces.

Tackboards for Spine Hutch B

PET TACKBOARD FOR SPINE HUTCH B			
H	W	Model Number	List
12	36	C-CTACK1236B	403
12	42	C-CTACK1242B	442
12	48	C-CTACK1248B	462
12	54	C-CTACK1254B	480
12	60	C-CTACK1260B	501
12	66	C-CTACK1266B	518
12	72	C-CTACK1272B	537
16	36	C-CTACK1636B	442
16	42	C-CTACK1642B	462
16	48	C-CTACK1648B	480
16	54	C-CTACK1654B	518
16	60	C-CTACK1660B	537
16	66	C-CTACK1666B	557
16	72	C-CTACK1672B	576
20	36	C-CTACK2036B	462
20	42	C-CTACK2042B	501
20	48	C-CTACK2048B	518
20	54	C-CTACK2054B	537
20	60	C-CTACK2060B	576
20	66	C-CTACK2066B	594
20	72	C-CTACK2072B	634

FABRIC TACKBOARD FOR SPINE HUTCH B					
H	W	Model Number	List	Fabric Grade C	Fabric Grade D
12	36	C-CTACKF1236B	736	+11	+23
12	42	C-CTACKF1242B	745	+11	+23
12	48	C-CTACKF1248B	764	+11	+23
12	54	C-CTACKF1254B	783	+11	+23
12	60	C-CTACKF1260B	804	+11	+23
12	66	C-CTACKF1266B	789	+11	+23
12	72	C-CTACKF1272B	805	+11	+23
16	36	C-CTACKF1636B	760	+17	+37
16	42	C-CTACKF1642B	769	+17	+37
16	48	C-CTACKF1648B	788	+17	+37
16	54	C-CTACKF1654B	805	+17	+37
16	60	C-CTACKF1660B	823	+17	+37
16	66	C-CTACKF1666B	850	+17	+37
16	72	C-CTACKF1672B	870	+17	+37
20	36	C-CTACKF2036B	783	+23	+50
20	42	C-CTACKF2042B	795	+23	+50
20	48	C-CTACKF2048B	814	+23	+50
20	54	C-CTACKF2054B	835	+23	+50
20	60	C-CTACKF2060B	855	+23	+50
20	66	C-CTACKF2066B	875	+23	+50
20	72	C-CTACKF2072B	898	+23	+50

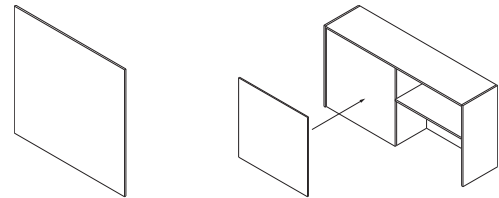
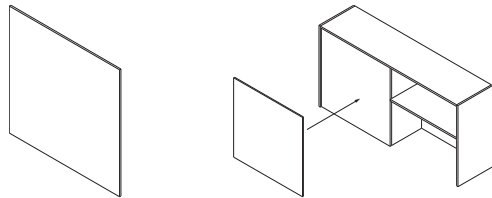

Specify

- Color Selection for PET- Lite Grey, Medium Grey, Tan or Vibrant Blue

Notes

- Match each tackboard to it's specific hutch using height, width and style dimensions.
- On PET tackboards, tack holes may remain visible after tacks have been removed.

Specify

- Fabric Selection

Notes

- Match each tackboard to it's specific hutch using height, width and style dimensions.
- Tackboard fabric direction is vertical on 24" to 48" wide units and will run horizontally for 54" to 96" wide pieces.

Tackboards for Spine Hutch B

PET TACKBOARD FOR SPINE HUTCH B

H	W	Model Number	List
28	36	C-CTACK2836B	518
28	42	C-CTACK2842B	557
28	48	C-CTACK2848B	576
28	54	C-CTACK2854B	614
28	60	C-CTACK2860B	652
28	66	C-CTACK2866B	692
28	72	C-CTACK2872B	710
36	36	C-CTACK3636B	576
36	42	C-CTACK3642B	614
36	48	C-CTACK3648B	652
36	54	C-CTACK3654B	692
36	60	C-CTACK3660B	728
36	66	C-CTACK3666B	767
36	72	C-CTACK3672B	805

FABRIC TACKBOARD FOR SPINE HUTCH B

H	W	Model Number	List	Fabric Grade C	Fabric Grade D
28	36	C-CTACKF2836B	830	+34	+73
28	42	C-CTACKF2842B	844	+34	+73
28	48	C-CTACKF2848B	861	+34	+73
28	54	C-CTACKF2854B	876	+34	+73
28	60	C-CTACKF2860B	891	+34	+73
28	66	C-CTACKF2866B	997	+34	+73
28	72	C-CTACKF2872B	1,029	+34	+73
36	36	C-CTACKF3636B	876	+46	+100
36	42	C-CTACKF3642B	896	+46	+100
36	48	C-CTACKF3648B	916	+46	+100
36	54	C-CTACKF3654B	938	+46	+100
36	60	C-CTACKF3660B	956	+46	+100
36	66	C-CTACKF3666B	1,049	+46	+100
36	72	C-CTACKF3672B	1,083	+46	+100

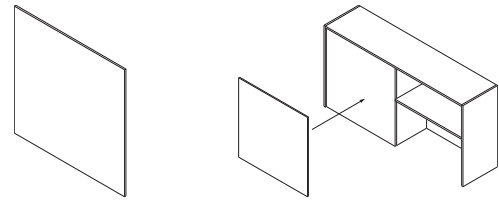
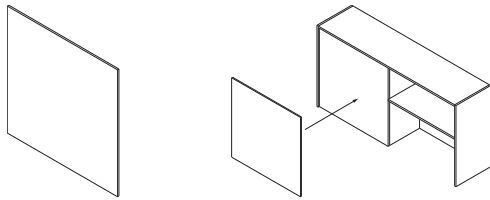

Specify

Notes

- Color Selection for PET- Lite Grey, Medium Grey, Tan or Vibrant Blue

- Match each tackboard to it's specific hutch using height, width and style dimensions.
- On PET tackboards, tack holes may remain visible after tacks have been removed.

Specify

Notes

- Fabric Selection

- Match each tackboard to it's specific hutch using height, width and style dimensions.
- Tackboard fabric direction is vertical on 24" to 48" wide units and will run horizontally for 54" to 96" wide pieces.

Tackboards for Spine Hutch C

PET TACKBOARD FOR SPINE HUTCH C

H	W	Model Number	List
20	24	C-CTACK2024C	403
20	30	C-CTACK2030C	442
20	36	C-CTACK2036C	462
20	42	C-CTACK2042C	501
20	48	C-CTACK2048C	518
20	54	C-CTACK2054C	537
20	60	C-CTACK2060C	576
20	66	C-CTACK2066C	594
20	72	C-CTACK2072C	634
20	78	C-CTACK2078C	652
20	84	C-CTACK2084C	672
28	24	C-CTACK2824C	442
28	30	C-CTACK2830C	480
28	36	C-CTACK2836C	518
28	42	C-CTACK2842C	557
28	48	C-CTACK2848C	576
28	54	C-CTACK2854C	614
28	60	C-CTACK2860C	652
28	66	C-CTACK2866C	692
28	72	C-CTACK2872C	710
28	78	C-CTACK2878C	748
28	84	C-CTACK2884C	787
36	24	C-CTACK3624C	480
36	30	C-CTACK3630C	537
36	36	C-CTACK3636C	576
36	42	C-CTACK3642C	614
36	48	C-CTACK3648C	652
36	54	C-CTACK3654C	692
36	60	C-CTACK3660C	728
36	66	C-CTACK3666C	767
36	72	C-CTACK3672C	805
36	78	C-CTACK3678C	844
36	84	C-CTACK3684C	881

FABRIC TACKBOARD FOR SPINE HUTCH C

H	W	Model Number	List	Fabric Grade C	Fabric Grade D
20	24	C-CTACKF2024C	760	+11	+23
20	30	C-CTACKF2030C	771	+11	+23
20	36	C-CTACKF2036C	783	+11	+23
20	42	C-CTACKF2042C	795	+11	+23
20	48	C-CTACKF2048C	814	+11	+23
20	54	C-CTACKF2054C	835	+11	+23
20	60	C-CTACKF2060C	855	+11	+23
20	66	C-CTACKF2066C	875	+11	+23
20	72	C-CTACKF2072C	898	+11	+23
20	78	C-CTACKF2078C	920	+11	+23
20	84	C-CTACKF2084C	941	+11	+23
28	24	C-CTACKF2824C	801	+17	+37
28	30	C-CTACKF2830C	815	+17	+37
28	36	C-CTACKF2836C	830	+17	+37
28	42	C-CTACKF2842C	844	+17	+37
28	48	C-CTACKF2848C	861	+17	+37
28	54	C-CTACKF2854C	876	+17	+37
28	60	C-CTACKF2860C	891	+17	+37
28	66	C-CTACKF2866C	997	+17	+37
28	72	C-CTACKF2872C	1,029	+17	+37
28	78	C-CTACKF2878C	1,060	+17	+37
28	84	C-CTACKF2884C	1,091	+17	+37
36	24	C-CTACKF3624C	840	+23	+50
36	30	C-CTACKF3630C	859	+23	+50
36	36	C-CTACKF3636C	876	+23	+50
36	42	C-CTACKF3642C	896	+23	+50
36	48	C-CTACKF3648C	916	+23	+50
36	54	C-CTACKF3654C	938	+23	+50
36	60	C-CTACKF3660C	956	+23	+50
36	66	C-CTACKF3666C	1,049	+23	+50
36	72	C-CTACKF3672C	1,083	+23	+50
36	78	C-CTACKF3678C	1,116	+23	+50
36	84	C-CTACKF3684C	1,150	+23	+50

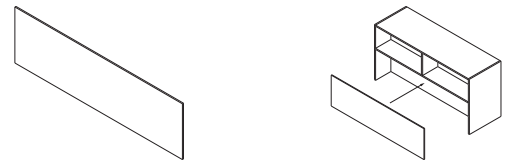
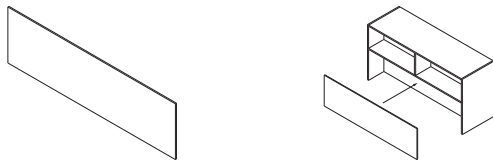

- | | |
|--|--|
| <p>Specify</p> <ul style="list-style-type: none"> • Color Selection for PET- Lite Grey, Medium Grey, Tan or Vibrant Blue | <p>Notes</p> <ul style="list-style-type: none"> • Match each tackboard to it's specific hutch using height, width and style dimensions. • On PET tackboards, tack holes may remain visible after tacks have been removed. |
|--|--|

- | | |
|--|--|
| <p>Specify</p> <ul style="list-style-type: none"> • Fabric Selection | <p>Notes</p> <ul style="list-style-type: none"> • Match each tackboard to it's specific hutch using height, width and style dimensions. • Tackboard fabric direction is vertical on 24" to 48" wide units and will run horizontally for 54" to 96" wide pieces. |
|--|--|

Tackboards for Spine Hutch C

PET TACKBOARD FOR SPINE HUTCH C WITH CUBBY

H	W	Cubby Size Used For	Model Number	List
28	24	16	C-CTACK2824C16	403
28	30	16	C-CTACK2830C16	442
28	36	16	C-CTACK2836C16	462
28	42	16	C-CTACK2842C16	501
28	48	16	C-CTACK2848C16	518
28	54	16	C-CTACK2854C16	537
28	60	16	C-CTACK2860C16	576
28	66	16	C-CTACK2866C16	594
28	72	16	C-CTACK2872C16	634
28	78	16	C-CTACK2878C16	652
28	84	16	C-CTACK2884C16	672
36	24	8	C-CTACK3624C08	517
36	30	8	C-CTACK3630C08	575
36	36	8	C-CTACK3636C08	614
36	42	8	C-CTACK3642C08	652
36	48	8	C-CTACK3648C08	688
36	54	8	C-CTACK3654C08	728
36	60	8	C-CTACK3660C08	766
36	66	8	C-CTACK3666C08	805
36	72	8	C-CTACK3672C08	843
36	78	8	C-CTACK3678C08	881
36	84	8	C-CTACK3684C08	918

FABRIC TACKBOARD FOR SPINE HUTCH C WITH CUBBY

H	W	Cubby Size Used For	Model Number	List	Fabric Grade C	Fabric Grade D
28	24	16	C-CTACKF2824C16	760	+11	+23
28	30	16	C-CTACKF2830C16	771	+11	+23
28	36	16	C-CTACKF2836C16	783	+11	+23
28	42	16	C-CTACKF2842C16	795	+11	+23
28	48	16	C-CTACKF2848C16	814	+11	+23
28	54	16	C-CTACKF2854C16	835	+11	+23
28	60	16	C-CTACKF2860C16	855	+11	+23
28	66	16	C-CTACKF2866C16	875	+11	+23
28	72	16	C-CTACKF2872C16	922	+11	+23
28	78	16	C-CTACKF2878C16	920	+11	+23
28	84	16	C-CTACKF2884C16	941	+11	+23
36	24	8	C-CTACKF3624C08	877	+26	+63
36	30	8	C-CTACKF3630C08	897	+26	+63
36	36	8	C-CTACKF3636C08	914	+26	+63
36	42	8	C-CTACKF3642C08	934	+26	+63
36	48	8	C-CTACKF3648C08	954	+26	+63
36	54	8	C-CTACKF3654C08	976	+26	+63
36	60	8	C-CTACKF3660C08	994	+26	+63
36	66	8	C-CTACKF3666C08	1,087	+26	+63
36	72	8	C-CTACKF3672C08	1,120	+26	+63
36	78	8	C-CTACKF3678C08	1,153	+26	+63
36	84	8	C-CTACKF3684C08	1,187	+26	+63

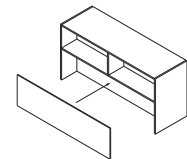
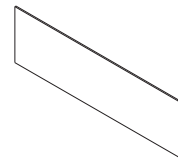
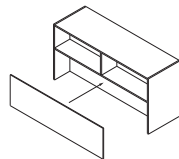
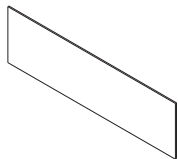

Specify

Notes

- Color Selection for PET- Lite Grey, Medium Grey, Tan or Vibrant Blue

- Match each tackboard to it's specific hutch using height, width and style dimensions.
- On PET tackboards, tack holes may remain visible after tacks have been removed.

Specify

Notes

- Fabric Selection

- Match each tackboard to it's specific hutch using height, width and style dimensions.
- Tackboard fabric direction is vertical on 24" to 48" wide units and will run horizontally for 54" to 96" wide pieces.

Tackboards for Spine Hutch D

PET TACKBOARD FOR SPINE HUTCH D

H	W	Model Number	List
20	36	C-CTACK2036D	462
20	42	C-CTACK2042D	501
20	48	C-CTACK2048D	518
20	54	C-CTACK2054D	537
20	60	C-CTACK2060D	576
20	66	C-CTACK2066D	594
20	72	C-CTACK2072D	634
20	78	C-CTACK2078D	652
20	84	C-CTACK2084D	672
28	36	C-CTACK2836D	518
28	42	C-CTACK2842D	557
28	48	C-CTACK2848D	576
28	54	C-CTACK2854D	614
28	60	C-CTACK2860D	652
28	66	C-CTACK2866D	692
28	72	C-CTACK2872D	710
28	78	C-CTACK2878D	748
28	84	C-CTACK2884D	787
36	36	C-CTACK3636D	576
36	42	C-CTACK3642D	614
36	48	C-CTACK3648D	652
36	54	C-CTACK3654D	692
36	60	C-CTACK3660D	728
36	66	C-CTACK3666D	767
36	72	C-CTACK3672D	805
36	78	C-CTACK3678D	844
36	84	C-CTACK3684D	881

FABRIC TACKBOARD FOR SPINE HUTCH D

H	W	Model Number	List	Fabric Grade C	Fabric Grade D
20	36	C-CTACKF2036D	783	+11	+23
20	42	C-CTACKF2042D	795	+11	+23
20	48	C-CTACKF2048D	814	+11	+23
20	54	C-CTACKF2054D	835	+11	+23
20	60	C-CTACKF2060D	855	+11	+23
20	66	C-CTACKF2066D	875	+11	+23
20	72	C-CTACKF2072D	898	+11	+23
20	78	C-CTACKF2078D	920	+11	+23
20	84	C-CTACKF2084D	941	+11	+23
28	36	C-CTACKF2836D	830	+17	+37
28	42	C-CTACKF2842D	844	+17	+37
28	48	C-CTACKF2848D	861	+17	+37
28	54	C-CTACKF2854D	876	+17	+37
28	60	C-CTACKF2860D	891	+17	+37
28	66	C-CTACKF2866D	997	+17	+37
28	72	C-CTACKF2872D	1,029	+17	+37
28	78	C-CTACKF2878D	1,060	+17	+37
28	84	C-CTACKF2884D	1,091	+17	+37
36	36	C-CTACKF3636D	876	+23	+50
36	42	C-CTACKF3642D	896	+23	+50
36	48	C-CTACKF3648D	916	+23	+50
36	54	C-CTACKF3654D	938	+23	+50
36	60	C-CTACKF3660D	956	+23	+50
36	66	C-CTACKF3666D	1,049	+23	+50
36	72	C-CTACKF3672D	1,083	+23	+50
36	78	C-CTACKF3678D	1,116	+23	+50
36	84	C-CTACKF3684D	1,150	+23	+50

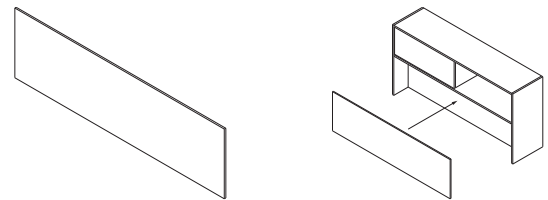
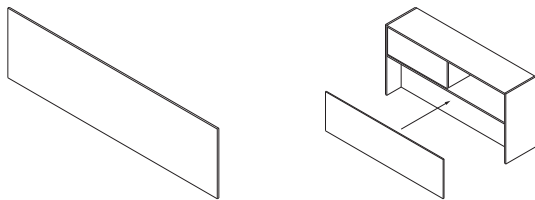

Specify

- Color Selection for PET- Lite Grey, Medium Grey, Tan or Vibrant Blue

Notes

- Match each tackboard to its specific hutch using height, width and style dimensions.
- On PET tackboards, tack holes may remain visible after tacks have been removed.

Specify

- Fabric Selection

Notes

- Match each tackboard to its specific hutch using height, width and style dimensions.
- Tackboard fabric direction is vertical on 24" to 48" wide units and will run horizontally for 54" to 96" wide pieces.

Tackboards for Spine Hutch D

PET TACKBOARD FOR SPINE HUTCH D WITH CUBBY

H	W	Cubby Size Used For	Model Number	List
28	36	16	C-CTACK2836D16	462
28	42	16	C-CTACK2842D16	501
28	48	16	C-CTACK2848D16	518
28	54	16	C-CTACK2854D16	537
28	60	16	C-CTACK2860D16	576
28	66	16	C-CTACK2866D16	594
28	72	16	C-CTACK2872D16	634
28	78	16	C-CTACK2878D16	652
28	84	16	C-CTACK2884D16	672
36	36	8	C-CTACK3636D08	614
36	42	8	C-CTACK3642D08	652
36	48	8	C-CTACK3648D08	688
36	54	8	C-CTACK3654D08	728
36	60	8	C-CTACK3660D08	766
36	66	8	C-CTACK3666D08	805
36	72	8	C-CTACK3672D08	843
36	78	8	C-CTACK3678D08	881
36	84	8	C-CTACK3684D08	918

FABRIC TACKBOARD FOR SPINE HUTCH D WITH CUBBY

H	W	Cubby Size Used For	Model Number	List	Fabric Grade C	Fabric Grade D
28	36	16	C-CTACKF2836D16	783	+11	+23
28	42	16	C-CTACKF2842D16	795	+11	+23
28	48	16	C-CTACKF2848D16	814	+11	+23
28	54	16	C-CTACKF2854D16	835	+11	+23
28	60	16	C-CTACKF2860D16	855	+11	+23
28	66	16	C-CTACKF2866D16	875	+11	+23
28	72	16	C-CTACKF2872D16	922	+11	+23
28	78	16	C-CTACKF2878D16	920	+11	+23
28	84	16	C-CTACKF2884D16	941	+11	+23
36	36	8	C-CTACKF3636D08	914	+26	+63
36	42	8	C-CTACKF3642D08	934	+26	+63
36	48	8	C-CTACKF3648D08	954	+26	+63
36	54	8	C-CTACKF3654D08	976	+26	+63
36	60	8	C-CTACKF3660D08	994	+26	+63
36	66	8	C-CTACKF3666D08	1,087	+26	+63
36	72	8	C-CTACKF3672D08	1,120	+26	+63
36	78	8	C-CTACKF3678D08	1,153	+26	+63
36	84	8	C-CTACKF3684D08	1,187	+26	+63

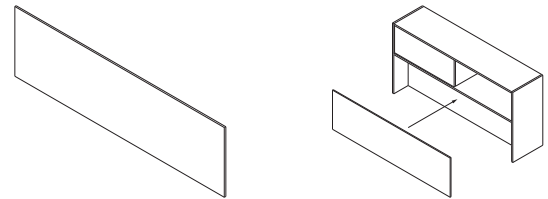
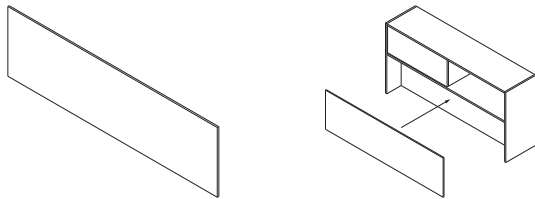

Specify **Notes**

- Color Selection for PET- Lite Grey, Medium Grey, Tan or Vibrant Blue
- Match each tackboard to it's specific hutch using height, width and style dimensions.
- On PET tackboards, tack holes may remain visible after tacks have been removed.

Specify **Notes**

- Fabric Selection
- Match each tackboard to it's specific hutch using height, width and style dimensions.
- Tackboard fabric direction is vertical on 24" to 48" wide units and will run horizontally for 54" to 96" wide pieces.

Tackboards for Spine Hutch E

PET TACKBOARD FOR SPINE HUTCH E

H	W	Model Number	List
28	36	C-CTACK2836E	518
28	42	C-CTACK2842E	557
28	48	C-CTACK2848E	576
28	54	C-CTACK2854E	614
28	60	C-CTACK2860E	652
28	66	C-CTACK2866E	692
28	72	C-CTACK2872E	710
28	78	C-CTACK2878E	748
28	84	C-CTACK2884E	787
36	36	C-CTACK3636E	576
36	42	C-CTACK3642E	614
36	48	C-CTACK3648E	652
36	54	C-CTACK3654E	692
36	60	C-CTACK3660E	728
36	66	C-CTACK3666E	767
36	72	C-CTACK3672E	805
36	78	C-CTACK3678E	844
36	84	C-CTACK3684E	881

FABRIC TACKBOARD FOR SPINE HUTCH E

H	W	Model Number	List	Fabric Grade C	Fabric Grade D
28	36	C-CTACKF2836E	830	+11	+23
28	42	C-CTACKF2842E	844	+11	+23
28	48	C-CTACKF2848E	861	+11	+23
28	54	C-CTACKF2854E	876	+11	+23
28	60	C-CTACKF2860E	891	+11	+23
28	66	C-CTACKF2866E	997	+11	+23
28	72	C-CTACKF2872E	1,029	+11	+23
28	78	C-CTACKF2878E	1,060	+11	+23
28	84	C-CTACKF2884E	1,091	+11	+23
36	36	C-CTACKF3636E	876	+23	+50
36	42	C-CTACKF3642E	896	+23	+50
36	48	C-CTACKF3648E	916	+23	+50
36	54	C-CTACKF3654E	938	+23	+50
36	60	C-CTACKF3660E	956	+23	+50
36	66	C-CTACKF3666E	1,049	+23	+50
36	72	C-CTACKF3672E	1,083	+23	+50
36	78	C-CTACKF3678E	1,116	+23	+50
36	84	C-CTACKF3684E	1,150	+23	+50

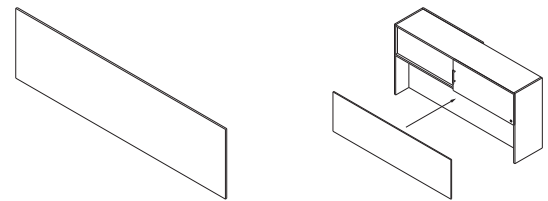
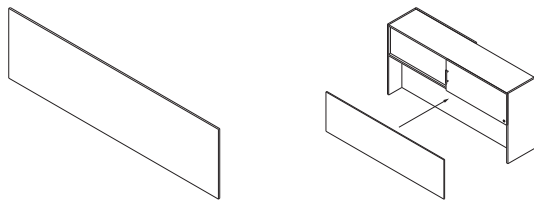

Specify **Notes**

- Color Selection for PET- Lite Grey, Medium Grey, Tan or Vibrant Blue
- Match each tackboard to it's specific hutch using height, width and style dimensions.
- On PET tackboards, tack holes may remain visible after tacks have been removed.

Specify **Notes**

- Fabric Selection
- Match each tackboard to it's specific hutch using height, width and style dimensions.
- Tackboard fabric direction is vertical on 24" to 48" wide units and will run horizontally for 54" to 96" wide pieces.

Tackboards for Spine Hutch G

PET TACKBOARD FOR SPINE HUTCH G

H	W	Model Number	List
20	24	C-CTACK2024G	403
20	30	C-CTACK2030G	442
20	36	C-CTACK2036G	462
20	42	C-CTACK2042G	501
20	48	C-CTACK2048G	518
20	54	C-CTACK2054G	537
20	60	C-CTACK2060G	576
20	66	C-CTACK2066G	594
20	72	C-CTACK2072G	634
20	78	C-CTACK2078G	652
20	84	C-CTACK2084G	672
28	24	C-CTACK2824G	442
28	30	C-CTACK2830G	480
28	36	C-CTACK2836G	518
28	42	C-CTACK2842G	557
28	48	C-CTACK2848G	576
28	54	C-CTACK2854G	614
28	60	C-CTACK2860G	652
28	66	C-CTACK2866G	692
28	72	C-CTACK2872G	710
28	78	C-CTACK2878G	748
28	84	C-CTACK2884G	787
36	24	C-CTACK3624G	480
36	30	C-CTACK3630G	537
36	36	C-CTACK3636G	576
36	42	C-CTACK3642G	614
36	48	C-CTACK3648G	652
36	54	C-CTACK3654G	692
36	60	C-CTACK3660G	728
36	66	C-CTACK3666G	767
36	72	C-CTACK3672G	805
36	78	C-CTACK3678G	844
36	84	C-CTACK3684G	881

FABRIC TACKBOARD FOR SPINE HUTCH G

H	W	Model Number	List	Fabric Grade C	Fabric Grade D
20	24	C-CTACKF2024G	760	+11	+23
20	30	C-CTACKF2030G	771	+11	+23
20	36	C-CTACKF2036G	783	+11	+23
20	42	C-CTACKF2042G	795	+11	+23
20	48	C-CTACKF2048G	814	+11	+23
20	54	C-CTACKF2054G	835	+11	+23
20	60	C-CTACKF2060G	855	+11	+23
20	66	C-CTACKF2066G	875	+11	+23
20	72	C-CTACKF2072G	898	+11	+23
20	78	C-CTACKF2078G	920	+11	+23
20	84	C-CTACKF2084G	941	+11	+23
28	24	C-CTACKF2824G	801	+23	+50
28	30	C-CTACKF2830G	815	+23	+50
28	36	C-CTACKF2836G	830	+23	+50
28	42	C-CTACKF2842G	844	+23	+50
28	48	C-CTACKF2848G	861	+23	+50
28	54	C-CTACKF2854G	876	+23	+50
28	60	C-CTACKF2860G	891	+23	+50
28	66	C-CTACKF2866G	997	+23	+50
28	72	C-CTACKF2872G	1,029	+23	+50
28	78	C-CTACKF2878G	1,060	+23	+50
28	84	C-CTACKF2884G	1,091	+23	+50
36	24	C-CTACKF3624G	840	+23	+50
36	30	C-CTACKF3630G	859	+23	+50
36	36	C-CTACKF3636G	876	+23	+50
36	42	C-CTACKF3642G	896	+23	+50
36	48	C-CTACKF3648G	916	+23	+50
36	54	C-CTACKF3654G	938	+23	+50
36	60	C-CTACKF3660G	956	+23	+50
36	66	C-CTACKF3666G	1,049	+23	+50
36	72	C-CTACKF3672G	1,083	+23	+50
36	78	C-CTACKF3678G	1,116	+23	+50
36	84	C-CTACKF3684G	1,150	+23	+50

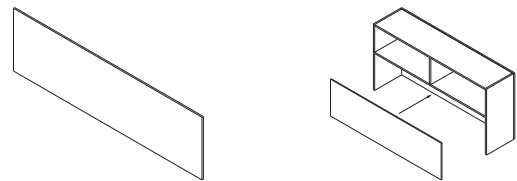
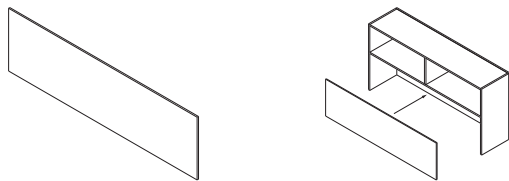

Specify **Notes**

- Color Selection for PET-Lite Grey, Medium Grey, Tan or Vibrant Blue
- Match each tackboard to its specific hutch using height, width and style dimensions.
- On PET tackboards, tack holes may remain visible after tacks have been removed.

Specify **Notes**

- Fabric Selection
- Match each tackboard to its specific hutch using height, width and style dimensions.
- Tackboard fabric direction is vertical on 24" to 48" wide units and will run horizontally for 54" to 96" wide pieces.

Tackboards for Spine Hutch G

PET TACKBOARD FOR SPINE HUTCH G WITH CUBBY

H	W	Cubby Size Used For	Model Number	List
28	24	16	C-CTACK2824G16	403
28	30	16	C-CTACK2830G16	442
28	36	16	C-CTACK2836G16	462
28	42	16	C-CTACK2842G16	501
28	48	16	C-CTACK2848G16	518
28	54	16	C-CTACK2854G16	537
28	60	16	C-CTACK2860G16	576
28	66	16	C-CTACK2866G16	594
28	72	16	C-CTACK2872G16	634
28	78	16	C-CTACK2878G16	652
28	84	16	C-CTACK2884G16	672
36	24	8	C-CTACK3624G08	517
36	30	8	C-CTACK3630G08	575
36	36	8	C-CTACK3636G08	614
36	42	8	C-CTACK3642G08	652
36	48	8	C-CTACK3648G08	688
36	54	8	C-CTACK3654G08	728
36	60	8	C-CTACK3660G08	766
36	66	8	C-CTACK3666G08	805
36	72	8	C-CTACK3672G08	843
36	78	8	C-CTACK3678G08	881
36	84	8	C-CTACK3684G08	918

FABRIC TACKBOARD FOR SPINE HUTCH G WITH CUBBY

H	W	Cubby Size Used For	Model Number	List	Fabric Grade C	Fabric Grade D
28	24	16	C-CTACKF2824G16	760	+11	+23
28	30	16	C-CTACKF2830G16	771	+11	+23
28	36	16	C-CTACKF2836G16	783	+11	+23
28	42	16	C-CTACKF2842G16	795	+11	+23
28	48	16	C-CTACKF2848G16	814	+11	+23
28	54	16	C-CTACKF2854G16	835	+11	+23
28	60	16	C-CTACKF2860G16	855	+11	+23
28	66	16	C-CTACKF2866G16	875	+11	+23
28	72	16	C-CTACKF2872G16	898	+11	+23
28	78	16	C-CTACKF2878G16	920	+11	+23
28	84	16	C-CTACKF2884G16	941	+11	+23
36	24	8	C-CTACKF3624G08	877	+26	+63
36	30	8	C-CTACKF3630G08	897	+26	+63
36	36	8	C-CTACKF3636G08	914	+26	+63
36	42	8	C-CTACKF3642G08	934	+26	+63
36	48	8	C-CTACKF3648G08	954	+26	+63
36	54	8	C-CTACKF3654G08	976	+26	+63
36	60	8	C-CTACKF3660G08	994	+26	+63
36	66	8	C-CTACKF3666G08	1,087	+26	+63
36	72	8	C-CTACKF3672G08	1,120	+26	+63
36	78	8	C-CTACKF3678G08	1,153	+26	+63
36	84	8	C-CTACKF3684G08	1,187	+26	+63

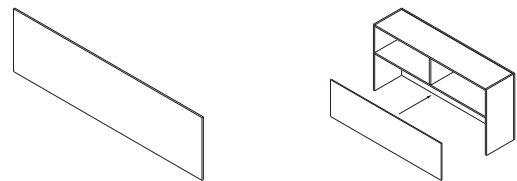
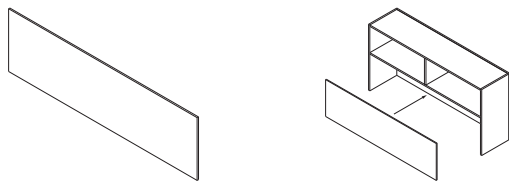

Specify **Notes**

- Color Selection for PET- Lite Grey, Medium Grey, Tan or Vibrant Blue
- Match each tackboard to it's specific hutch using height, width and style dimensions.
- On PET tackboards, tack holes may remain visible after tacks have been removed.

Specify **Notes**

- Fabric Selection
- Match each tackboard to it's specific hutch using height, width and style dimensions.
- Tackboard fabric direction is vertical on 24" to 48" wide units and will run horizontally for 54" to 96" wide pieces.

Tackboards for Spine Hutch H (Cantilevered)

PET TACKBOARD FOR SPINE HUTCH H (CANTILEVERED)

H	W	Model Number	List
20	60	C-CTACK2060H	576
20	66	C-CTACK2066H	594
20	72	C-CTACK2072H	634
20	78	C-CTACK2078H	652
20	84	C-CTACK2084H	672
28	60	C-CTACK2860H	652
28	66	C-CTACK2866H	692
28	72	C-CTACK2872H	710
28	78	C-CTACK2878H	748
28	84	C-CTACK2884H	787
36	60	C-CTACK3660H	728
36	66	C-CTACK3666H	767
36	72	C-CTACK3672H	805
36	78	C-CTACK3678H	844
36	84	C-CTACK3684H	881

FABRIC TACKBOARD FOR SPINE HUTCH H (CANTILEVERED)

H	W	Model Number	List	Fabric Grade C	Fabric Grade D
20	60	C-CTACKF2060H	855	+11	+23
20	66	C-CTACKF2066H	875	+11	+23
20	72	C-CTACKF2072H	898	+11	+23
20	78	C-CTACKF2078H	920	+11	+23
20	84	C-CTACKF2084H	941	+11	+23
28	60	C-CTACKF2860H	891	+23	+50
28	66	C-CTACKF2866H	997	+23	+50
28	72	C-CTACKF2872H	1,029	+23	+50
28	78	C-CTACKF2878H	1,060	+23	+50
28	84	C-CTACKF2884H	1,091	+23	+50
36	60	C-CTACKF3660H	956	+23	+50
36	66	C-CTACKF3666H	1,049	+23	+50
36	72	C-CTACKF3672H	1,083	+23	+50
36	78	C-CTACKF3678H	1,116	+23	+50
36	84	C-CTACKF3684H	1,150	+23	+50

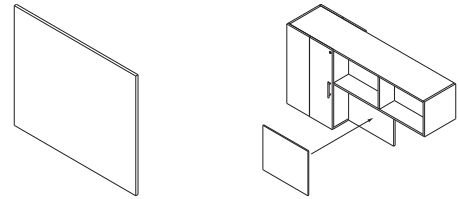
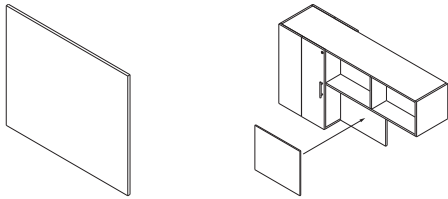

Specify **Notes**

- Color Selection for PET- Lite Grey, Medium Grey, Tan or Vibrant Blue
- Match each tackboard to it's specific hutch using height, width and style dimensions.
- On PET tackboards, tack holes may remain visible after tacks have been removed.

Specify **Notes**

- Fabric Selection
- Match each tackboard to it's specific hutch using height, width and style dimensions.
- Tackboard fabric direction is vertical on 24" to 48" wide units and will run horizontally for 54" to 96" wide pieces.

Tackboards for Spine Hutch H (Cantilevered)

PET TACKBOARD FOR SPINE HUTCH H WITH CUBBY (CANTILEVERED)

H	W	Cubby Size Used For	Model Number	List
36	60	8	C-CTACK3660H08	766
36	66	8	C-CTACK3666H08	805
36	72	8	C-CTACK3672H08	843
36	78	8	C-CTACK3678H08	881
36	84	8	C-CTACK3684H08	918

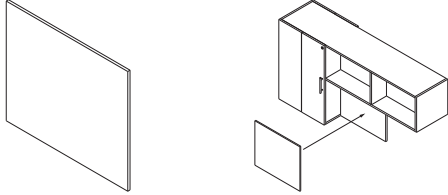

Specify

Notes

- Color Selection for PET- Lite Grey, Medium Grey, Tan or Vibrant Blue
- Match each tackboard to it's specific hutch using height, width and style dimensions.
- On PET tackboards, tack holes may remain visible after tacks have been removed.

FABRIC TACKBOARD FOR SPINE HUTCH H WITH CUBBY (CANTILEVERED)

H	W	Cubby Size Used For	Model Number	List	Fabric Grade C	Fabric Grade D
36	60	8	C-CTACKF3660H08	994	+26	+63
36	66	8	C-CTACKF3666H08	1,087	+26	+63
36	72	8	C-CTACKF3672H08	1,120	+26	+63
36	78	8	C-CTACKF3678H08	1,153	+26	+63
36	84	8	C-CTACKF3684H08	1,187	+26	+63

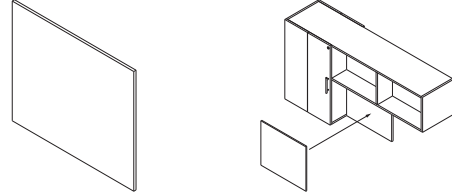

Specify

Notes

- Fabric Selection
- Match each tackboard to it's specific hutch using height, width and style dimensions.
- Tackboard fabric direction is vertical on 24" to 48" wide units and will run horizontally for 54" to 96" wide pieces.

Tackboards for Spine Hutch H (Full Panel)

PET TACKBOARD FOR SPINE HUTCH H (FULL PANEL)

H	W	Model Number	List
20	60	C-CTACK2060HF	480
20	66	C-CTACK2066HF	501
20	72	C-CTACK2072HF	518
20	78	C-CTACK2078HF	537
20	84	C-CTACK2084HF	557
28	60	C-CTACK2860HF	537
28	66	C-CTACK2866HF	557
28	72	C-CTACK2872HF	594
28	78	C-CTACK2878HF	594
28	84	C-CTACK2884HF	634
36	60	C-CTACK3660HF	557
36	66	C-CTACK3666HF	576
36	72	C-CTACK3672HF	594
36	78	C-CTACK3678HF	614
36	84	C-CTACK3684HF	634

FABRIC TACKBOARD FOR SPINE HUTCH H (FULL PANEL)

H	W	Model Number	List	Fabric Grade C	Fabric Grade D
20	60	C-CTACKF2060HF	736	+11	+23
20	66	C-CTACKF2066HF	746	+11	+23
20	72	C-CTACKF2072HF	764	+11	+23
20	78	C-CTACKF2078HF	764	+11	+23
20	84	C-CTACKF2084HF	786	+11	+23
28	60	C-CTACKF2860HF	783	+23	+50
28	66	C-CTACKF2866HF	795	+23	+50
28	72	C-CTACKF2872HF	814	+23	+50
28	78	C-CTACKF2878HF	814	+23	+50
28	84	C-CTACKF2884HF	835	+23	+50
36	60	C-CTACKF3660HF	783	+23	+50
36	66	C-CTACKF3666HF	795	+23	+50
36	72	C-CTACKF3672HF	814	+23	+50
36	78	C-CTACKF3678HF	814	+23	+50
36	84	C-CTACKF3684HF	835	+23	+50

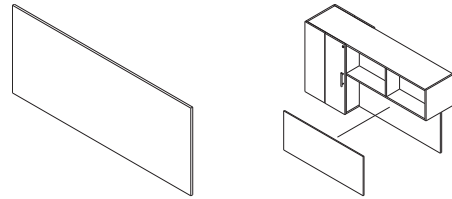
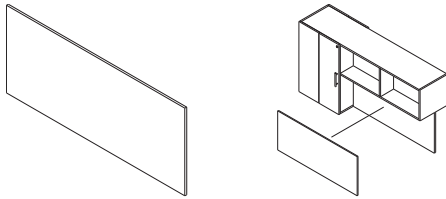

Specify **Notes**

- Color Selection for PET- Lite Grey, Medium Grey, Tan or Vibrant Blue
- Match each tackboard to it's specific hutch using height, width and style dimensions.
- On PET tackboards, tack holes may remain visible after tacks have been removed.

Specify **Notes**

- Fabric Selection
- Match each tackboard to it's specific hutch using height, width and style dimensions.
- Tackboard fabric direction is vertical on 24" to 48" wide units and will run horizontally for 54" to 96" wide pieces.

Tackboards for Spine Hutch H (Full Panel)

PET TACKBOARD FOR SPINE HUTCH H WITH CUBBY (FULL PANEL)

H	W	Cubby Size Used For	Model Number	List
36	60	8	C-CTACK3660HF08	594
36	66	8	C-CTACK3666HF08	614
36	72	8	C-CTACK3672HF08	632
36	78	8	C-CTACK3678HF08	652
36	84	8	C-CTACK3684HF08	672

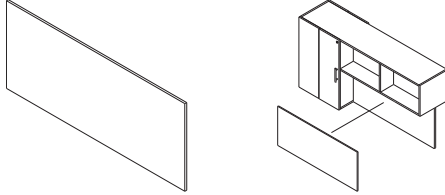

Specify

Notes

- Color Selection for PET- Lite Grey, Medium Grey, Tan or Vibrant Blue
- Match each tackboard to it's specific hutch using height, width and style dimensions.
- On PET tackboards, tack holes may remain visible after tacks have been removed.

FABRIC TACKBOARD FOR SPINE HUTCH H WITH CUBBY (FULL PANEL)

H	W	Cubby Size Used For	Model Number	List	Fabric Grade C	Fabric Grade D
36	60	8	C-CTACKF3660HF8	820	+26	+63
36	66	8	C-CTACKF3666HF8	833	+26	+63
36	72	8	C-CTACKF3672HF8	850	+26	+63
36	78	8	C-CTACKF3678HF8	850	+26	+63
36	84	8	C-CTACKF3684HF8	873	+26	+63

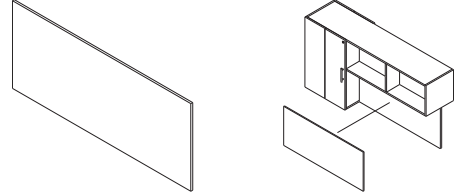

Specify

Notes

- Fabric Selection
- Match each tackboard to it's specific hutch using height, width and style dimensions.
- Tackboard fabric direction is vertical on 24" to 48" wide units and will run horizontally for 54" to 96" wide pieces.

Tackboards for Spine Hutch J

PET TACKBOARD FOR SPINE HUTCH J

H	W	Model Number	List
20	60	C-CTACK2060J	576
20	66	C-CTACK2066J	594
20	72	C-CTACK2072J	634
20	78	C-CTACK2078J	652
20	84	C-CTACK2084J	672
28	60	C-CTACK2860J	652
28	66	C-CTACK2866J	692
28	72	C-CTACK2872J	710
28	78	C-CTACK2878J	748
28	84	C-CTACK2884J	787
36	60	C-CTACK3660J	728
36	66	C-CTACK3666J	767
36	72	C-CTACK3672J	805
36	78	C-CTACK3678J	844
36	84	C-CTACK3684J	881

FABRIC TACKBOARD FOR SPINE HUTCH J

H	W	Model Number	List	Fabric Grade C	Fabric Grade D
20	60	C-CTACKF2060J	855	+11	+23
20	66	C-CTACKF2066J	875	+11	+23
20	72	C-CTACKF2072J	898	+11	+23
20	78	C-CTACKF2078J	920	+11	+23
20	84	C-CTACKF2084J	941	+11	+23
28	60	C-CTACKF2860J	891	+23	+50
28	66	C-CTACKF2866J	997	+23	+50
28	72	C-CTACKF2872J	1,029	+23	+50
28	78	C-CTACKF2878J	1,060	+23	+50
28	84	C-CTACKF2884J	1,091	+23	+50
36	60	C-CTACKF3660J	956	+23	+50
36	66	C-CTACKF3666J	1,049	+23	+50
36	72	C-CTACKF3672J	1,083	+23	+50
36	78	C-CTACKF3678J	1,116	+23	+50
36	84	C-CTACKF3684J	1,150	+23	+50

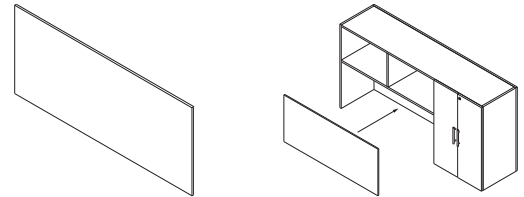
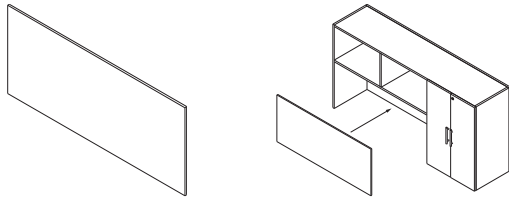

Specify **Notes**

- Color Selection for PET- Lite Grey, Medium Grey, Tan or Vibrant Blue
- Match each tackboard to it's specific hutch using height, width and style dimensions.
- On PET tackboards, tack holes may remain visible after tacks have been removed.

Specify **Notes**

- Fabric Selection
- Match each tackboard to it's specific hutch using height, width and style dimensions.
- Tackboard fabric direction is vertical on 24" to 48" wide units and will run horizontally for 54" to 96" wide pieces.

Tackboards for Spine Hutch J

PET TACKBOARD FOR SPINE HUTCH J WITH CUBBY

H	W	Cubby Size Used For	Model Number	List
36	60	8	C-CTACK3660J08	766
36	66	8	C-CTACK3666J08	805
36	72	8	C-CTACK3672J08	843
36	78	8	C-CTACK3678J08	881
36	84	8	C-CTACK3684J08	918

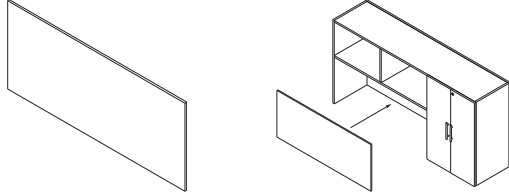

Specify

- Color Selection for PET- Lite Grey, Medium Grey, Tan or Vibrant Blue

Notes

- Match each tackboard to it's specific hutch using height, width and style dimensions.
- On PET tackboards, tack holes may remain visible after tacks have been removed.

FABRIC TACKBOARD FOR SPINE HUTCH J WITH CUBBY

H	W	Cubby Size Used For	Model Number	List	Fabric Grade C	Fabric Grade D
36	60	8	C-CTACKF3660J08	994	+26	+63
36	66	8	C-CTACKF3666J08	1,087	+26	+63
36	72	8	C-CTACKF3672J08	1,120	+26	+63
36	78	8	C-CTACKF3678J08	1,153	+26	+63
36	84	8	C-CTACKF3684J08	1,187	+26	+63

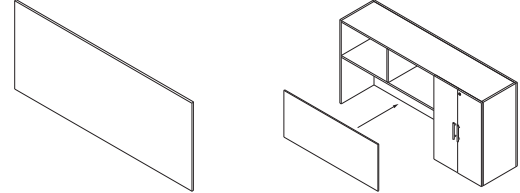

Specify

- Fabric Selection

Notes

- Match each tackboard to it's specific hutch using height, width and style dimensions.
- Tackboard fabric direction is vertical on 24" to 48" wide units and will run horizontally for 54" to 96" wide pieces.

Tackboards for Spine Hutch K

PET TACKBOARD FOR SPINE HUTCH K

H	W	Model Number	List
28	36	C-CTACK2836K	518
28	42	C-CTACK2842K	557
28	48	C-CTACK2848K	576
28	54	C-CTACK2854K	614
28	60	C-CTACK2860K	652
28	66	C-CTACK2866K	692
28	72	C-CTACK2872K	710
28	78	C-CTACK2878K	748
28	84	C-CTACK2884K	787
36	36	C-CTACK3636K	576
36	42	C-CTACK3642K	614
36	48	C-CTACK3648K	652
36	54	C-CTACK3654K	692
36	60	C-CTACK3660K	728
36	66	C-CTACK3666K	767
36	72	C-CTACK3672K	805
36	78	C-CTACK3678K	844
36	84	C-CTACK3684K	881

FABRIC TACKBOARD FOR SPINE HUTCH K

H	W	Model Number	List	Fabric Grade C	Fabric Grade D
28	36	C-CTACKF2836K	830	+17	+37
28	42	C-CTACKF2842K	844	+17	+37
28	48	C-CTACKF2848K	861	+17	+37
28	54	C-CTACKF2854K	876	+17	+37
28	60	C-CTACKF2860K	891	+17	+37
28	66	C-CTACKF2866K	997	+17	+37
28	72	C-CTACKF2872K	1,029	+17	+37
28	78	C-CTACKF2878K	1,060	+17	+37
28	84	C-CTACKF2884K	1,091	+17	+37
36	36	C-CTACKF3636K	876	+23	+50
36	42	C-CTACKF3642K	896	+23	+50
36	48	C-CTACKF3648K	916	+23	+50
36	54	C-CTACKF3654K	938	+23	+50
36	60	C-CTACKF3660K	956	+23	+50
36	66	C-CTACKF3666K	1,049	+23	+50
36	72	C-CTACKF3672K	1,083	+23	+50
36	78	C-CTACKF3678K	1,116	+23	+50
36	84	C-CTACKF3684K	1,150	+23	+50

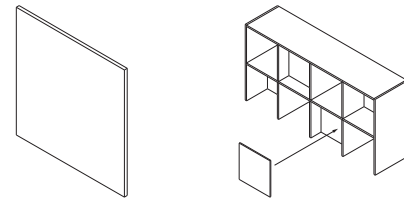
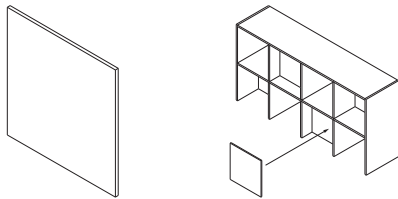

Specify **Notes**

- Color Selection for PET- Lite Grey, Medium Grey, Tan or Vibrant Blue
- Match each tackboard to it's specific hutch using height, width and style dimensions.
- Each tackboard is sold individually (not as a set).
- On PET tackboards, tack holes may remain visible after tacks have been removed.

Specify **Notes**

- Fabric Selection
- Match each tackboard to it's specific hutch using height, width and style dimensions.
- Tackboard fabric direction is vertical on 24" to 48" wide units and will run horizontally for 54" to 96" wide pieces.

Tackboards for Spine Hutch N

PET TACKBOARD FOR SPINE HUTCH N

H	W	Model Number	List
28	24	C-CTACK2824N	442
28	30	C-CTACK2830N	480
28	36	C-CTACK2836N	518
28	42	C-CTACK2842N	557
28	48	C-CTACK2848N	576
28	54	C-CTACK2854N	614
28	60	C-CTACK2860N	652
28	66	C-CTACK2866N	692
28	72	C-CTACK2872N	710
36	24	C-CTACK3624N	480
36	30	C-CTACK3630N	537
36	36	C-CTACK3636N	576
36	42	C-CTACK3642N	614
36	48	C-CTACK3648N	652
36	54	C-CTACK3654N	692
36	60	C-CTACK3660N	728
36	66	C-CTACK3666N	767
36	72	C-CTACK3672N	805

FABRIC TACKBOARD FOR SPINE HUTCH N

H	W	Model Number	List	Fabric Grade C	Fabric Grade D
28	24	C-CTACKF2824N	801	+23	+50
28	30	C-CTACKF2830N	815	+23	+50
28	36	C-CTACKF2836N	830	+23	+50
28	42	C-CTACKF2842N	844	+23	+50
28	48	C-CTACKF2848N	861	+23	+50
28	54	C-CTACKF2854N	876	+23	+50
28	60	C-CTACKF2860N	891	+23	+50
28	66	C-CTACKF2866N	997	+23	+50
28	72	C-CTACKF2872N	1,029	+23	+50
28	78	C-CTACKF2878N	1,060	+23	+50
28	84	C-CTACKF2884N	1,091	+23	+50
36	24	C-CTACKF3624N	840	+23	+50
36	30	C-CTACKF3630N	859	+23	+50
36	36	C-CTACKF3636N	876	+23	+50
36	42	C-CTACKF3642N	896	+23	+50
36	48	C-CTACKF3648N	916	+23	+50
36	54	C-CTACKF3654N	938	+23	+50
36	60	C-CTACKF3660N	956	+23	+50
36	66	C-CTACKF3666N	1,049	+23	+50
36	72	C-CTACKF3672N	1,083	+23	+50

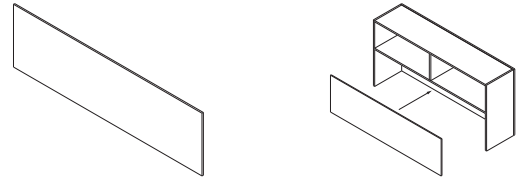
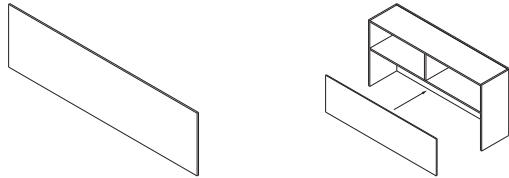

Specify **Notes**

- Color Selection for PET-Lite Grey, Medium Grey, Tan or Vibrant Blue
- Match each tackboard to it's specific hutch using height, width and style dimensions.
- On PET tackboards, tack holes may remain visible after tacks have been removed.

Specify **Notes**

- Fabric Selection
- Match each tackboard to it's specific hutch using height, width and style dimensions.
- Tackboard fabric direction is vertical on 24" to 48" wide units and will run horizontally for 54" to 96" wide pieces.

Tackboards for Spine Hutch R

PET TACKBOARD FOR SPINE HUTCH R

H	W	Model Number	List
12	24	C-CTACK1224R	366
12	30	C-CTACK1230R	385
12	36	C-CTACK1236R	403
12	42	C-CTACK1242R	442
12	48	C-CTACK1248R	462
12	54	C-CTACK1254R	480
12	60	C-CTACK1260R	501
12	66	C-CTACK1266R	518
12	72	C-CTACK1272R	537
16	24	C-CTACK1624R	385
16	30	C-CTACK1630R	423
16	36	C-CTACK1636R	442
16	42	C-CTACK1642R	462
16	48	C-CTACK1648R	480
16	54	C-CTACK1654R	518
16	60	C-CTACK1660R	537
16	66	C-CTACK1666R	557
16	72	C-CTACK1672R	576
20	24	C-CTACK2024R	403
20	30	C-CTACK2030R	442
20	36	C-CTACK2036R	462
20	42	C-CTACK2042R	501
20	48	C-CTACK2048R	518
20	54	C-CTACK2054R	537
20	60	C-CTACK2060R	576
20	66	C-CTACK2066R	594
20	72	C-CTACK2072R	634

FABRIC TACKBOARD FOR SPINE HUTCH R

H	W	Model Number	List	Fabric Grade C	Fabric Grade D
12	24	C-CTACKF1224R	720	+11	+23
12	30	C-CTACKF1230R	728	+11	+23
12	36	C-CTACKF1236R	736	+11	+23
12	42	C-CTACKF1242R	745	+11	+23
12	48	C-CTACKF1248R	764	+11	+23
12	54	C-CTACKF1254R	783	+11	+23
12	60	C-CTACKF1260R	804	+11	+23
12	66	C-CTACKF1266R	789	+11	+23
12	72	C-CTACKF1272R	805	+11	+23
16	24	C-CTACKF1624R	739	+17	+37
16	30	C-CTACKF1630R	749	+17	+37
16	36	C-CTACKF1636R	760	+17	+37
16	42	C-CTACKF1642R	769	+17	+37
16	48	C-CTACKF1648R	788	+17	+37
16	54	C-CTACKF1654R	805	+17	+37
16	60	C-CTACKF1660R	823	+17	+37
16	66	C-CTACKF1666R	850	+17	+37
16	72	C-CTACKF1672R	870	+17	+37
20	24	C-CTACKF2024R	760	+23	+50
20	30	C-CTACKF2030R	771	+23	+50
20	36	C-CTACKF2036R	783	+23	+50
20	42	C-CTACKF2042R	795	+23	+50
20	48	C-CTACKF2048R	814	+23	+50
20	54	C-CTACKF2054R	835	+23	+50
20	60	C-CTACKF2060R	855	+23	+50
20	66	C-CTACKF2066R	875	+23	+50
20	72	C-CTACKF2072R	898	+23	+50

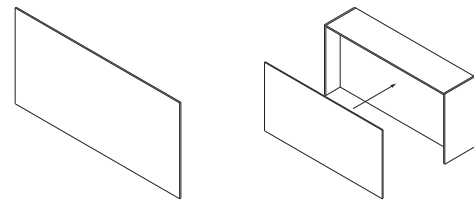
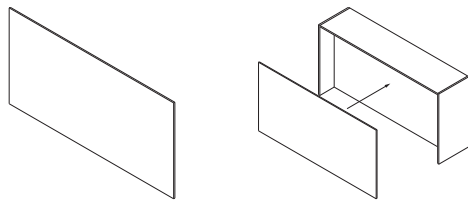

Specify

- Color Selection for PET- Lite Grey, Medium Grey, Tan or Vibrant Blue

Notes

- Match each tackboard to its specific hutch using height, width and style dimensions.
- On PET tackboards, tack holes may remain visible after tacks have been removed.

Specify

- Fabric Selection

Notes

- Match each tackboard to its specific hutch using height, width and style dimensions.
- Tackboard fabric direction is vertical on 24" to 48" wide units and will run horizontally for 54" to 96" wide pieces.

Tackboards for Spine Hutch R

PET TACKBOARD FOR SPINE HUTCH R

H	W	Model Number	List
28	24	C-CTACK2824R	442
28	30	C-CTACK2830R	480
28	36	C-CTACK2836R	518
28	42	C-CTACK2842R	557
28	48	C-CTACK2848R	576
28	54	C-CTACK2854R	614
28	60	C-CTACK2860R	652
28	66	C-CTACK2866R	692
28	72	C-CTACK2872R	710
36	24	C-CTACK3624R	480
36	30	C-CTACK3630R	537
36	36	C-CTACK3636R	576
36	42	C-CTACK3642R	614
36	48	C-CTACK3648R	652
36	54	C-CTACK3654R	692
36	60	C-CTACK3660R	728
36	66	C-CTACK3666R	767
36	72	C-CTACK3672R	805

FABRIC TACKBOARD FOR SPINE HUTCH R

H	W	Model Number	List	Fabric Grade C	Fabric Grade D
28	24	C-CTACKF2824R	801	+34	+73
28	30	C-CTACKF2830R	815	+34	+73
28	36	C-CTACKF2836R	830	+34	+73
28	42	C-CTACKF2842R	844	+34	+73
28	48	C-CTACKF2848R	861	+34	+73
28	54	C-CTACKF2854R	876	+34	+73
28	60	C-CTACKF2860R	891	+34	+73
28	66	C-CTACKF2866R	997	+34	+73
28	72	C-CTACKF2872R	1,029	+34	+73
36	24	C-CTACKF3624R	840	+46	+100
36	30	C-CTACKF3630R	859	+46	+100
36	36	C-CTACKF3636R	876	+46	+100
36	42	C-CTACKF3642R	896	+46	+100
36	48	C-CTACKF3648R	916	+46	+100
36	54	C-CTACKF3654R	938	+46	+100
36	60	C-CTACKF3660R	956	+46	+100
36	66	C-CTACKF3666R	1,049	+46	+100
36	72	C-CTACKF3672R	1,083	+46	+100

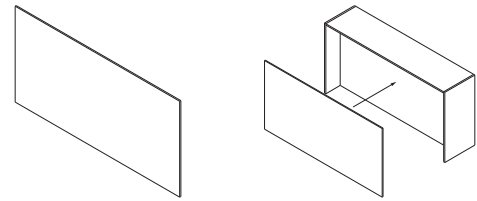
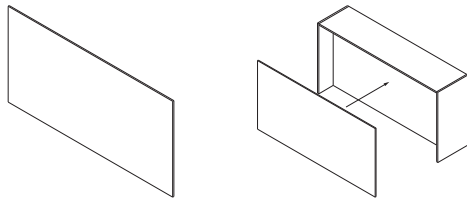

Specify **Notes**

- Color Selection for PET- Lite Grey, Medium Grey, Tan or Vibrant Blue
- Match each tackboard to it's specific hutch using height, width and style dimensions.
- On PET tackboards, tack holes may remain visible after tacks have been removed.

Specify **Notes**

- Fabric Selection
- Match each tackboard to it's specific hutch using height, width and style dimensions.
- Tackboard fabric direction is vertical on 24" to 48" wide units and will run horizontally for 54" to 96" wide pieces.

Soft Close Mechanism For Hinged Door

SOFT CLOSE MECHANISM FOR HINGED DOOR

Part Number

List

X-SOFTHINGE

38

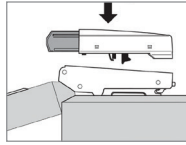
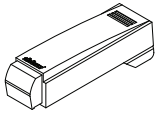

Notes

- Mounting method: snaps on to hinge. No tools required.
- Material: steel
- Color/finish: Nickel-plated
- One required for doors up to 30" tall; doors between 31"H and 66"H – order two; doors over 66"H – order three.
- Compatible only with laminate storage; not compatible with L-Series metal storage.

GANGING KIT FOR CASEGOODS

Part Number

List

X-GANGKIT

15



Notes

- Used for ganging two casegoods together.



National Showrooms:

Leominster

AIS Headquarters
25 Tucker Drive
Leominster, MA 01453

Chicago

The Merchandise Mart
Suite 1086
Chicago, Illinois 60654

New York

AIS New York
257 Park Avenue South
New York, New York 10010

Washington, D.C.

AIS Washington, D.C.
1501 M St, NW, STE 230
Washington, D.C. 20005

GSA Sales

GSA Contract 47QSMA20D08Q4
Multiple Award Schedule (MAS)
Large Category: Furniture & Furnishings
Subcategories: Office Furniture, Packaged
Office Furniture and Furniture Services

For additional information on AIS:

Dealer Showrooms, Representative
Directory, Project Case Studies, Online
Catalog & Product Showcase
Visit: www.ais-inc.com