

CALIBRATE[®] SERIES CASEGOODS & RECEPTION

March 2023 Price List

AIS

PRODUCT INFORMATION

Calibrate Statement of Line 5
 Calibrate Finish Options 15
 Calibrate Product Details 18
 Calibrate Typicals 38

DESK SHELLS

24", 30" and 36" Deep Desk Shells 47
 Desk Shells with Access Modesties 48
 Desk Shells with Full Modesty Flushes and Desk Shell Center Supports 49
 Desk Returns 50
 Desk Bridges 51

RECEPTION

Reception Desk Shells and Returns 52
 Reception Corner Stack-On 53
 Reception Stack-Ons and Countertops 54

RUN-OFF WORKSURFACES

Rectangular Floating Run-Off Worksurfaces 55
 Radius Rectangular Floating Run-Off Worksurfaces 57
 Blade and Wedge Floating Run-Off Worksurfaces 58
 Run-Offs for 29" High Post Legs 59
 Run-Offs for Desk Shells 60
 Rectangular Run-Offs 61
 D Tops 63
 Stack-On Desks 64

TABLE DESKS

Rectangular and Round Corner Rectangular Table Desks (Fixed and Mobile) 66
 Square Table Desks (Fixed and Mobile) 67
 Round and Triangle Table Desks (Fixed and Mobile) 68
 Blade Table Desks (Fixed and Mobile) 69
 Blade Table Desks with Flat Sides (Fixed and Mobile) 70
 Wedge Table Desks (Fixed and Mobile) 71
 O-Leg Table Desks 72
 Cantilevered Height Adjustable Tables 73
 Cantilevered Height Adjustable Tables with Run-Offs 74
 3-Leg Cantilevered Height Adjustable Table Desks 76
 Cantilevered Height Adjustable Table Assembly Doors 78
 Enclosed Based Single Stage Height Adjustable Table Desks 79
 Telescoping Height Adjustable Executive Desks 80
 Height Adjustable Table Bases 81
 21" High Fixed Modesty HAT Base 82
 Height Adjustable Table Legs and Worksurfaces 84
 Calibrate 3-Leg Height Adjustable Tables Version 2 86
 Calibrate 3-Leg Height Adjustable Tables 90
 Foot Kits, End Panels and Modesties for Height Adjustable Tables 92
 Calibrate Combo Unit w/Integrated Calibrate Height Adjustable Table 93
 LB Lounge Corner and End Tables, Volker Cube Nesting Table 94

WALL MOUNTED STORAGE

Open Wall Mounted Storage 95
 Wall Mounted Storage with Cabinet Doors 96
 Wall Mounted Storage with Sliding Doors 97

Wall Mounted L Shelves 98
 Wall Panels 100
 Whiteboard Wall Panels. 102

SUSPENDED STORAGE

Suspended Utility Storage and Accessories 104

STORAGE

18" High Mobile Pedestals 105
 21" High BF Pedestals 106
 21" High Hidden Drawer BF Pedestals 107
 21" High Cubby Pedestals 108
 21" High Lateral Floor Storage 109
 36" High Floor Bookcases 110
 21" High Floor Bookcases 111
 21" High Floor Bookcases for Floating Tops and Shared Floor Bookcases 112
 36" High Floor Cabinets 113
 21" High Floor Cabinets 114
 21" High Floor Credenzas. 115
 21" High Combo Units with BF Pedestal and Bookcase 117
 21" High Non-Powered Access Cabinets. 118
 21" High Powered Access Cabinets 119
 28" High BBF Pedestals 120
 28" High FF Pedestals 121
 28" High BBF Laterals and Two Drawer Laterals 122
 28" High Floor Bookcases 123
 28" High Shared Floor Bookcases 124
 28" High Two Door Cabinets 125
 28" High Four Door Cabinets 126
 28" High Single Door Cabinets and Credenzas with Cabinet Doors 127
 28" High Credenzas with Sliding Doors. 128
 28" High Combo BBF and Combo FF Storage 129
 28" High Combo Laterals 130
 42" and 50" High Lateral Bookcases 131
 42" and 50" High Laterals with Sliding Doors 132
 42" and 50" Two Door Cabinets 133
 27", 42", 50" High Side Access Roll Out / Pantry Towers 134
 42" Three Drawer Laterals and 54" Four Drawer Laterals 135
 BF Wardrobe Towers 136
 BBF Wardrobe Towers 137
 FF Wardrobe Towers 138
 BF Pedestal Towers with Open Front 139
 BF Pedestal Towers with Open Side 140
 BF Pedestal Towers with Cupboard 141
 BBF Pedestal Towers with Open Front 142
 BBF Pedestal Towers with Open Side 143
 BBF Pedestal Towers with Cupboard. 144
 FF Pedestal Towers with Open Front 145
 FF Pedestal Towers with Open Side 146
 FF Pedestal Towers with Cupboard. 147
 BF Lateral Bookcases. 148
 BF Laterals with Cabinet Doors. 149
 BBF Lateral Bookcases. 150

BBF Lateral Bookcases with Divider 151

BBF Laterals with Cabinet Doors 152

FF Lateral Bookcases 153

FF Lateral Bookcases with Divider 154

FF Laterals with Cabinet Doors 155

66", 74" and 82" High Two Door Cabinets 156

Bookcases 157

Single Door Towers 158

Lockers 159

DRY PLANTERS

Calibrate Dry Planters. 161

Calibrate Stack-On Dry Planters 163

Calibrate Single Wrap Dry Planters 164

Calibrate Double Wrap Dry Planters 165

STACK-ON STORAGE

Stack-On Bookcases 166

Stack-On Cabinets and Wardrobes. 167

HUTCHES

Open Hutches. 168

Hutches with Cabinet Doors 170

Hutches with Sliding Doors 173

TACKBOARDS

Wall Mounted Tackboards 176

Tackboard Hutch Mounts for Calibrate 178

ACCESSORIES

Paper Flows. 179

Drawers 180

Locks and Keys. 181

Credenza and Pedestal Cushions 182

Monitor Arms 183

Task Lights 184

Electrical 185

U-Channels, Support Brackets and End Panel Risers 186

Task Light Wire Managers for Tackboards 187

File Bars. 188

Miscellaneous Accessories 189

Soft Close Mechanism For Hinged Door 190

WARRANTY & TERMS AND CONDITIONS

For Warranty & Terms and Conditions please visit:
<https://aiscmsprod.blob.core.windows.net/infocenter/AISTermsWarranty.pdf>

 Select items available on quick ship Calibrate Countdown program. See [Calibrate Countdown price list](#) for full details.

Note: Please see Screens Price Lists for Calibrate specific screens.

Desk Shells, Returns, Bridges, Reception and Run-Offs for Calibrate

DESK SHELLS

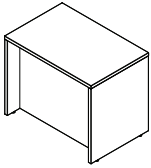

Desk Shell w/ Full Modesty Recessed

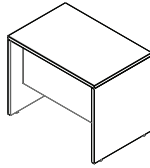

Desk Shell w/ Three-Quarter Modesty Recessed

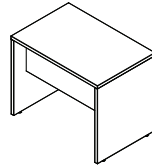

Desk Shell w/ Half Modesty Recessed

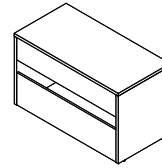

Desk Shell w/ Access Modesty

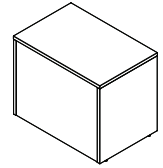

Desk Shell w/ Full Modesty Flush

RETURNS AND BRIDGES

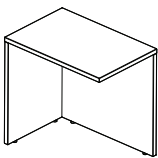

Desk Return
Left or Right
Left Return Shown

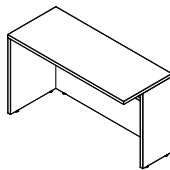

Desk Return w/ Access Modesty
Left or Right
Left Return Shown

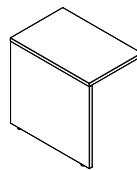

Desk Bridge w/ Full Modesty Flush

RECEPTION

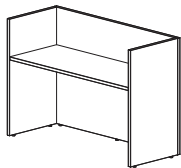

Reception Desk Shell

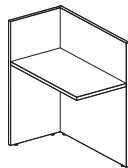

Receptions Return
Left or Right
Left Return Shown

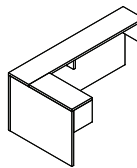

Reception Corner Stack-On

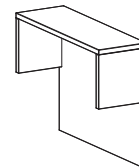

Reception Stack-On

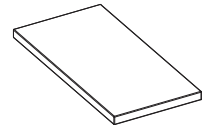

Reception Worksurface

RUN-OFFS

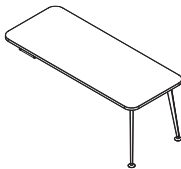

Radius Rect. Floating w/ Tapered Leg
2mm or Knife Edge
Powered or Non-Powered
Non-Powered Knife Edge Shown

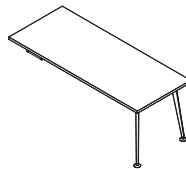

Rectangular Floating w/ Tapered Legs
2mm or Knife Edge
Powered or Non-Powered
Non-Powered Knife Edge Shown

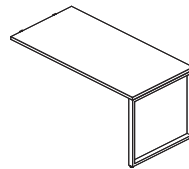

Rectangular Floating w/ O-Legs
2mm Edge
Powered or Non-Powered
Non-Powered 2mm Edge Shown

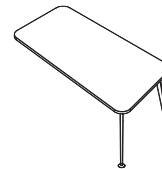

Blade Floating w/ Tapered Leg
Left or Right, 2mm or Knife Edge
Powered or Non-Powered
Non-Powered Right Knife Edge Shown

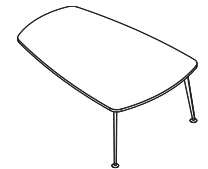

Wedge Floating w/ Tapered Leg
2mm or Knife Edge
Powered or Non-Powered
Non-Powered Knife Edge Shown

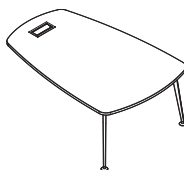

Wedge Floating w/ Tapered Leg Powered
2mm or Knife Edge
Knife Edge Shown

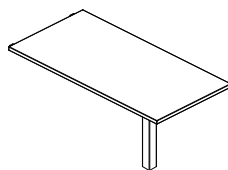

Rect. Run-Off for 29" High Post Leg
2mm or Knife Edge,
Square or Round Leg
2mm Edge with Square Leg Shown

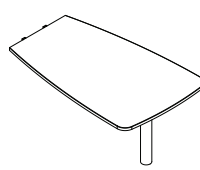

Wedge Run-Off for 29" High Post Legs
2mm or Knife Edge,
Square or Round Leg
2mm Edge with Round Leg Shown

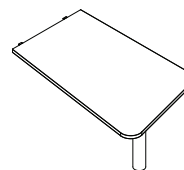

Blade Run-Off for 29" High Post Leg
Left or Right, 2mm or Knife Edge, Square
or Round Leg
Right 2mm Edge with Round Leg Shown

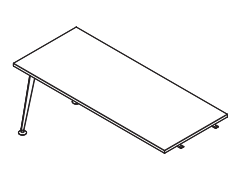

Rectangular Run-Off w/ Tapered Leg
for Desk Shells
2mm or Knife Edge
2mm Edge Shown

Run-Offs and Table Desks for Calibrate

RUN-OFFS

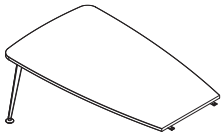

Wedge Run-Off w/ Tapered Leg for Desk Shell
2mm or Knife Edge
2mm Edge Shown

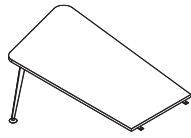

Blade Run-Off w/ Tapered Leg for Desk Shells
Left or Right, 2mm or Knife Edge
Left 2mm Edge Shown

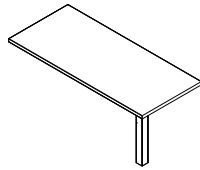

Rect. Run-Off w/ Post Leg
With or Without Modesty,
Square or Round Leg
Sq. Leg Without Modesty Shown

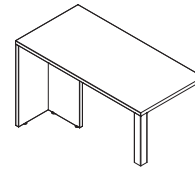

Rect. Run-Off w/ Post Leg Freestanding
With or Without Modesty,
Square or Round Leg
Sq. Leg Without Modesty Shown

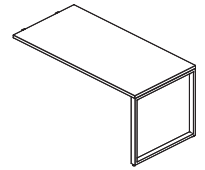

Rect. Run-Off w/ O-Legs

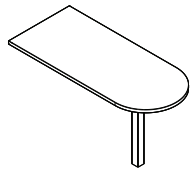

D Top
Square or Round Leg
Square Leg Shown

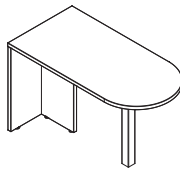

Freestanding D Top
With or Without Modesty,
Square or Round Leg
Sq. Leg Without Modesty Shown

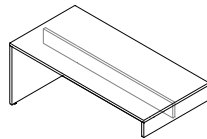

Stack-On Desk
Left Hand, Right Hand or Centered
Centered Stack-On Desk Shown

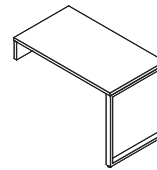

Stack-On Desk w/ O-Legs

TABLE DESKS

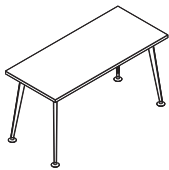

Rectangular Table w/ Tapered Post Legs
2mm or Knife Edge,
With or Without Casters
2mm Edge Without Casters Shown

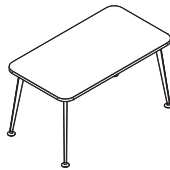

Round Corner Rectangular Table w/ Tapered Post Legs
2mm or Knife Edge,
With or Without Casters
2mm Edge Without Casters Shown

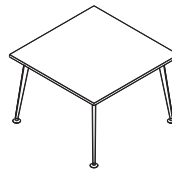

Square Table w/ Tapered Post Legs
2mm or Knife Edge,
With or Without Casters
2mm Edge Without Casters Shown

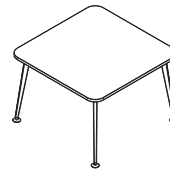

Round Corner Square Table w/ Tapered Post Legs
2mm or Knife Edge,
With or Without Casters
2mm Edge Without Casters Shown



Round Table w/ Tapered Post Legs
2mm or Knife Edge,
With or Without Casters
2mm Edge Without Caster Shown



Triangle Table w/ Tapered Post Legs
2mm or Knife Edge,
With or Without Casters
2mm Edge Without Casters Shown

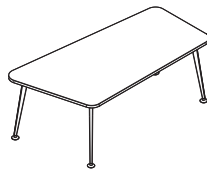

Blade Table w/ Tapered Post Legs
2mm or Knife Edge, Left or Right
With or Without Casters
Right 2mm Edge Without Casters Shown

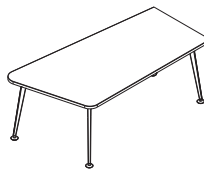

Blade Table w/ Flat Side and Tapered Post Legs
2mm or Knife Edge, Left or Right
With or Without Casters
Right 2mm Edge Without Casters Shown

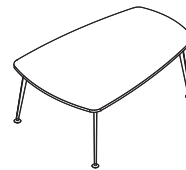

Wedge Table w/ Tapered Post Legs
2mm or Knife Edge,
With or Without Casters
2mm Edge Without Casters Shown

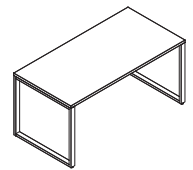

O-Leg Table Desks
2mm Edge

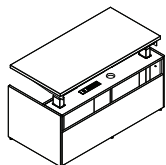

Cantilevered Height Adjustable Table Desk
Powered or Non-Powered
Powered (Back) Shown

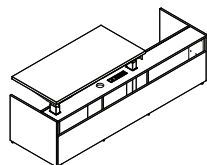

Cantilevered Height Adjustable Table Desk w/ Run-Offs
Powered or Non-Powered,
for Left or Right Runoff, 24 or 30 Depths
Powered (Left Back) Shown

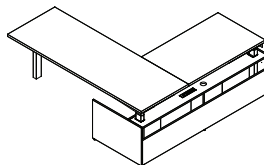

3-Leg Cantilevered Height Adjustable Table Desk
Powered or Non-Powered,
for Main Surface Left or Right
Powered (Back) Shown

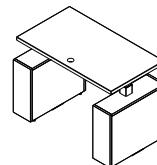

Executive Height Adjustable Desk
2mm or Knife Edge,
With or Without Fixed Modesty
Square Edge Without Modesty Shown

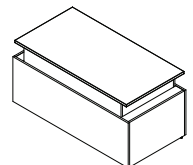

Telescoping Height Adjustable Executive Desk
2mm or Knife Edge,
2mm Edge Shown

Table Desks for Calibrate

TABLE DESKS

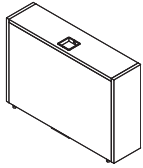

Height Adjustable Table Bases
24 or 30 Depths

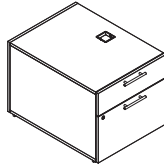

BF Height Adjustable Table Bases
24 or 30 Depths

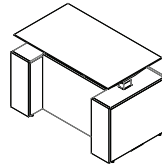

21" High Fixed Modesty HAT Base to
HAT Base
for use with 42, 48, 54, 60, 66, 72, 78, 84,
90, and 96 Wide Top

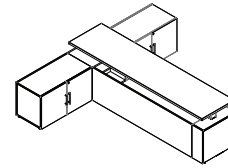

21" High Fixed Modesty HAT Base
18" to HAT Base
for use with 60, 66, 72, 78, 84, 90,
and 96 Wide Top,
18 and 24 Depths

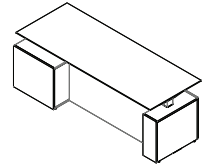

21" High Fixed Modesty HAT Base to
Box File HAT Base
for use with 60, 66, 72, 78, 84, 90,
and 96 Wide Top,

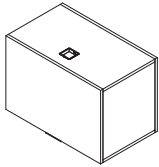

Height Adjustable Table Bases
With or Without Side Access,
Powered or Non-Powered
24 or 30 Wide, 18 or 24 Depths
Non-Powered Without Side Access Shown

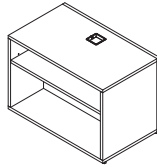

Height Adjustable Table Bases w/
Bookcase
With or Without Side Access,
18 or 24 Deep, 24 or 30 Wide

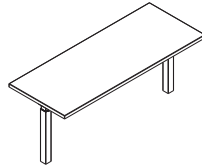

Height Adjustable Table
2-Leg Bases with Worksurfaces
2mm or Knife Edge
24 or 30 Deep, 48 - 84 Widths

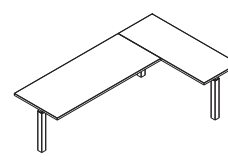

Height Adjustable Table
3-Leg Bases w/ Worksurfaces
2mm or Knife Edge
24/30 Deep, 48/42 - 84/72 Widths

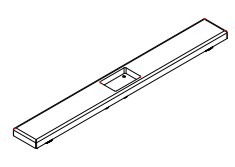

Height Adjustable Table
Single Foot Kit

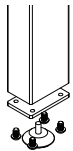

Height Adjustable Table
Foot Glide

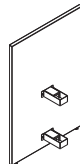

End Panels for
Calibrate Height Adjustable Tables

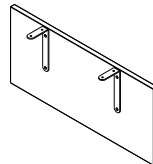

Height Adjustable Table Modesty
42 - 96 Widths

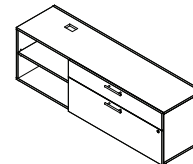

Combo Unit w/ Integrated Calibrate
Height Adjustable Table
24 or 30 Wide, 18 or 24 Depths
66 Wide x 24 Deep (Left) Shown

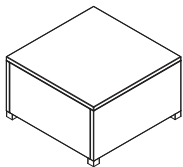

LB Lounge Corner Table
Powered or Non-Powered

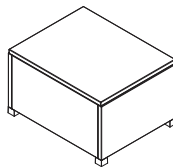

LB Lounge End Table
Powered or Non-Powered

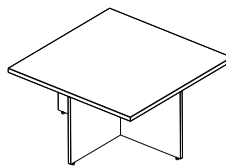

Volker Cube Nesting Table

Wall Mounted Storage and Suspended Storage for Calibrate

WALL MOUNTED STORAGE

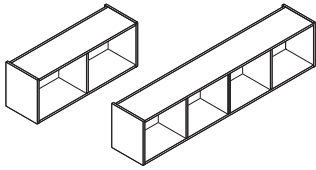

16" High Wall Mounted Open Overhead
36 - 96 Widths
42 and 72 Widths Shown

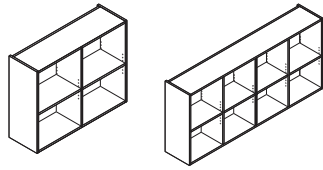

Wall Mounted Open Overhead Double Height
36 - 78 Widths
42 and 72 Widths Shown

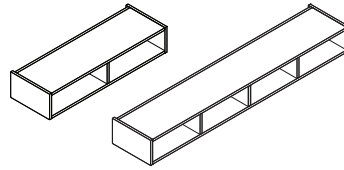

8" High Wall Mounted Open Overhead
36 - 96 Widths
42 and 72 Widths Shown

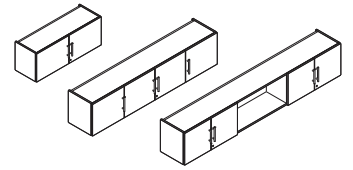

16" High Wall Mounted Overhead w/ Cabinet Doors
Laminate or Framed Doors, 36 - 96 Widths
Laminate Doors in 42, 72 and 90 Widths Shown

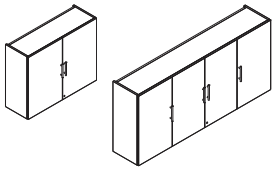

Double Height Wall Mounted Overhead w/ Cabinet Doors
Laminate or Framed Doors
36 - 78 Widths
Laminate Doors in 42 and 72 Widths Shown

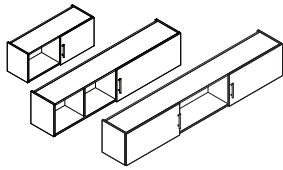

16" High Wall Mounted Overhead w/ Sliding Doors
Left or Right Hand
Laminate or Framed Sliding Doors
36 - 96 Widths
Right Side Lock Laminate Doors in 42, 72, 90 Widths Shown

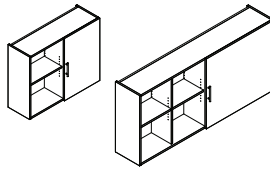

Double Height Wall Mounted Overhead w/ Sliding Doors
Left or Right Hand, Laminate or Framed Sliding Doors
36 - 78 Widths
Right Side Lock Laminate Doors in 42, 72 Widths Shown

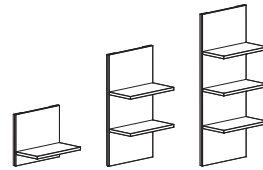

Wall Mounted L Shelves
16, 20, 28, 32, 36, 45, 52, 60 High
24 - 72 Widths, 12 Deep
28, 45 and 60 High Shown

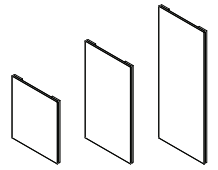

Wall Mounted Panels
16, 20, 28, 32, 36, 45, 52, 60 High
24 - 72 Widths, 1 1/2 Deep
28, 45 and 60 High Shown

SUSPENDED STORAGE

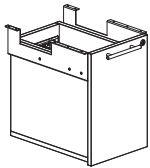

Powered Suspended Utility Storage

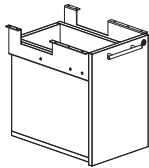

Non-Powered Suspended Utility Storage

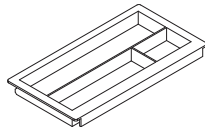

Suspended Utility Pencil Tray

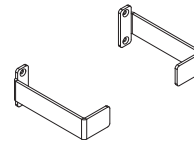

Hanging Folder Kits

Floor Storage for Calibrate

FLOOR STORAGE

21" High Floor Storage

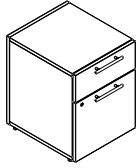

BF Pedestal
18, 22 or 24 Depths
On Glides, Feet or Casters
18 Depth Pedestal on Glides Shown

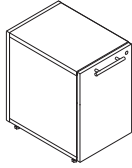

Hidden Drawer BF Pedestal
18, 22 or 24 Depths
On Glides, Feet or Casters
18 Depth Pedestal on Glides Shown

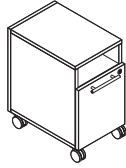

Cubby Pedestals
File, Box Box, Box or Hidden BF
On Casters
Cubby File on Casters Shown

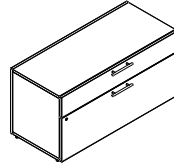

BF Lateral
30 - 42 Widths, 18, 22 or 24 Depths
On Glides or Feet
18 Depth, 42 Width on Glides Shown

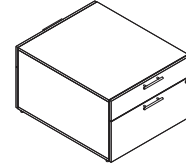

Double Pencil Lateral
30 - 42 Widths, 36 Deep
On Glides or Feet
30 Width on Glides Shown

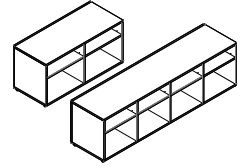

Floor Bookcase
24 - 72 Widths
On Glides or Feet
42 and 72 Widths on Glides Shown

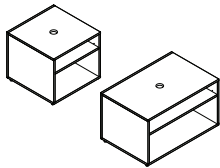

Floor Bookcase for Floating Tops
24 - 36 Widths, 18, 24 or 30 Depths
On Glides or Feet
24 and 36 Widths on Glides Shown

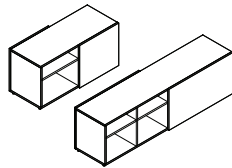

Shared Floor Bookcase
Left or Right Hand, 36 - 72 Widths, 18
Deep, On Glides or Feet
Left Hand 42 and 72 Widths on
Glides Shown

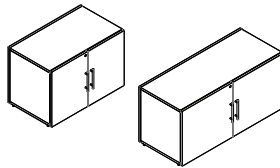

Two Door Cabinet
24 - 48 Widths, 18 Deep
On Glides or Feet
30 and 42 Widths on Glides Shown

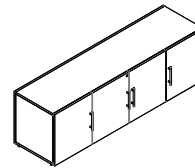

Four Door Cabinet
54 - 72 Widths, 18 Deep
On Glides or Feet
72 Width on Glides Shown

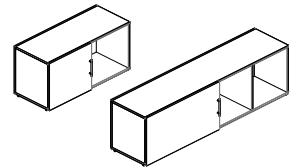

Credenza w/ Sliding Doors
Left or Right Side Lock
36 - 72 Widths, 18 Deep, On Glides or Feet
Left Side Lock in 42 and 72 Widths on
Glides Shown

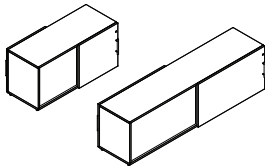

Shared Credenza w/ Sliding Doors
Left or Right Side Lock
36 - 72 Widths, 18 Deep, On Glides or Feet
Right Side Lock in 42 and 72 Widths on
Glides Shown

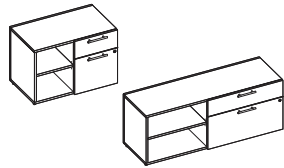

**Combo Unit w/
BF Pedestal and Bookcase**
30 - 72 Widths, 18 or 24 Depths
On Glides or Feet, Bookcase Left or Right
Bookcase Left 36 and 54 Deep on
Glides Shown

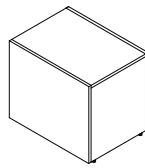

Non-Powered Access Cabinets
24 - 30 Widths, 18 - 24 Deep
Open or Closed Back
24 Wide, 18 Deep w/ Closed Back Shown

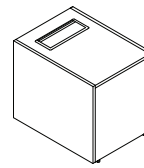

Powered Access Cabinets
24 - 30 Widths, 18 - 24 Deep
Open or Closed Back
24 Wide, 18 Deep w/ Closed Back Shown

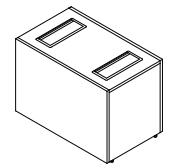

Double Powered Access Cabinets
24 - 30 Widths, 18 - 24 Deep
Open or Closed Back
24 Wide, 18 Deep w/ Closed Back Shown

28" High Floor Storage



BBF Pedestal
18, 23, 24, 29, 30 Depths
On Glides or Feet
Full Depth on Glides Shown

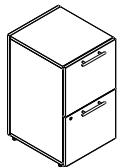

FF Pedestal
18, 23, 24, 29, 30 Depths
On Glides or Feet
Full Depth on Glides Shown

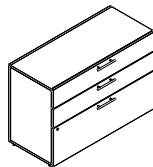

BBF Lateral
30 - 42 Widths, 18, 22, 24, 28 Depths
On Glides or Feet
Full Depth, 42 Width on Glides Shown

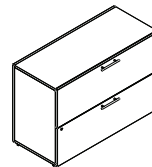

Two Drawer Lateral
30 - 42 Widths, 18, 22, 24, 28 Depths
On Glides or Feet
Full Depth, 42 Width on Glides Shown

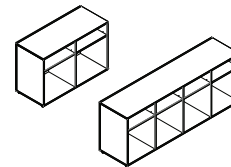

Floor Bookcase
24 - 72 Widths, 14, 18, 24 Depths
On Glides or Feet
42 and 72 Widths on Glides Shown

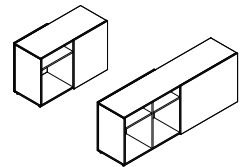

Shared Floor Bookcase
Left or Right Hand, 36 - 72 Widths,
18 Deep, On Glides or Feet
Left Hand 42 and 72 Widths on
Glides Shown

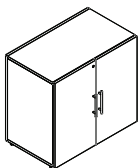

Two Door Cabinet
24 - 48 Widths, 18, 22, 24, 28 Depths
On Glides or Feet
Full Depth, 30 Width on Glides Shown

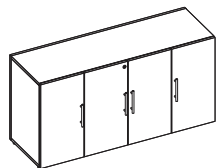

Four Door Cabinet
54 - 72 Widths, 18, 22, 24, 28 Depths
On Glides or Feet
54 Wide on Glides Shown

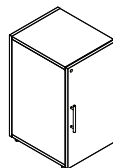

Single Door Tower
Left or Right Hinge
18, 24, 30 Depth, On Glides or Feet
Right-Hinge Door 18 Deep on Glides Shown

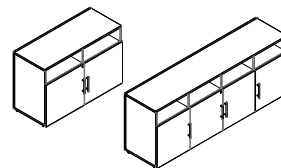

Credenza w/ Cabinet Doors
24 - 72 Widths, 18 Deep
On Glides or Feet
42 and 72 Widths on Glides Shown

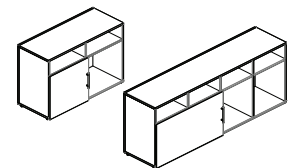

Credenza w/ Sliding Doors
Left or Right Hand,
36 - 72 Widths, 18 Deep, On Glides or Feet
Left Side Lock Doors in
42 and 72 Widths on Glides Shown

Floor Storage for Calibrate

28" High Floor Storage

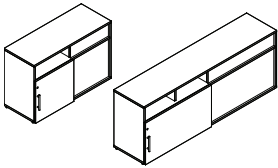

Shared Credenza w/ Sliding Doors
Left or Right Hand, 36 - 72 Widths, 18 Deep
On Glides or Feet
Left Side Lock Doors in
42 and 72 Widths on Glides Shown

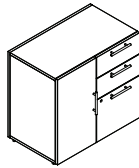

Combo BBF with Door
18, 22, 24, 28 Depths
Left or Right Door, On Glides or Feet
Full Depth w/ BBF Right, Door Left on
Glides Shown

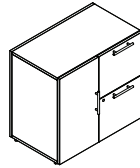

Combo FF with Door
18, 22, 24, 28 Depths
Left or Right Door, On Glides or Feet
Full Depth w/ FF Right, Door Left on
Glides Shown

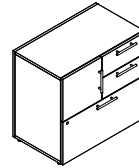

Combo Lateral w/ BB and Door
18, 22, 24, 28 Depths
Left or Right Door, On Glides or Feet
Full Depth w/ BB Right, Door Left on
Glides Shown

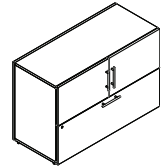

**Combo Lateral w/
Bottom Lateral and Top Doors**
30 - 42 Widths, 18, 22, 24, 28 Depths,
On Glides or Feet
Full Depth, 42 Width on Glides Shown

42" and Higher Floor Storage

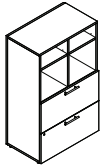

Lateral Bookcase
42 and 50 High, 18 Deep
On Glides or Feet
50 High on Glides Shown

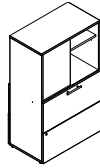

Shared Lateral Bookcase
42 and 50 High, 18 Deep
Left or Right Hand, On Glides or Feet,
Optional Writable Surface
Right Handed in 50 High on Glides Shown

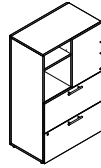

Lateral w/ Sliding Door
42 and 50 High, 18 Deep
Left or Right Hand, On Glides or Feet
Right Side Lock Door in 50 High on
Glides Shown

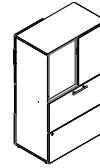

Shared Lateral w/ Sliding Door
42 and 50 High, 18 Deep
Left or Right Hand, On Glides or Feet,
Optional Writable Surface
Right Side Lock in 50 High on Glides Shown

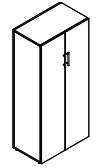

Two Door Cabinet
42, 50, 66, 74 and 82 High, 30, 36 and
42 Widths, 18, 24 and 30 Depths,
On Glides or Feet
66 High on Glides Shown



Single Door Tower
42, 50, 58, 66 and 74 High
12 Wide, 18, 24 and 30 Depths
Left or Right Hinge, On Glides Only
Right-Hinge Doors in 66 High Shown

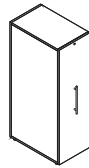

Side Access Roll-Out/Pantry Tower
27, 42 and 50 High
15 and 18 Wide, 24 and 30 Depths
Left or Right Handed, On Glides Only
Right Hand in 50 High Shown



42" High Three Drawer Lateral
30, 36 and 42 Wide, 18 and 24 Depths
On Glides or Feet
30 Wide, 18 Deep on Glides Shown

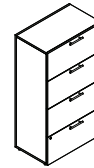

54" High Four Drawer Lateral
30, 36 and 42 Wide, 18 and 24 Depths
On Glides or Feet
30 Wide, 18 Deep on Glides Shown

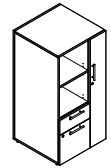

BF Wardrobe Tower w/ Open Front
50, 66, 74 and 82 High, 24 Deep
Right or Left Hand, On Glides or Feet
BF Left, Door Right in 50 High on
Glides Shown

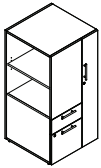

BF Wardrobe Tower w/ Open Side
50, 66, 74 and 82 High, 24 Deep
Right or Left Hand, On Glides or Feet*
BF Left, Door Right in 50 High on
Glides Shown

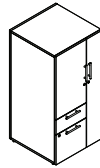

BF Wardrobe Tower with Cupboard
50, 66, 74 and 82 High, 24 Deep
Right or Left Hand, On Glides or Feet*
BF Left, Door Right in 50 High on
Glides Shown

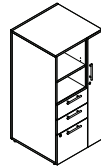

BBF Wardrobe Tower w/ Open Front
50, 66, 74 and 82 High, 24 Deep
Right or Left Hand, On Glides or Feet*
BBF Left, Door Right in 50 High on
Glides Shown

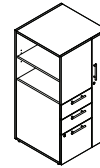

BBF Wardrobe Tower w/ Open Side
50, 66, 74 and 82 High, 24 Deep
Right or Left Hand, On Glides or Feet*
BBF Left, Door Right in 50 High Shown on
Glides Shown

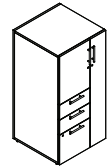

BBF Wardrobe Tower w/ Cupboard
50, 66, 74 and 82 High, 24 Deep
Right or Left Hand, On Glides or Feet*
BBF Left, Door Right in 50 High Shown on
Glides Shown

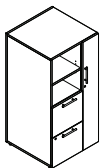

FF Wardrobe Tower w/ Open Front
50, 66, 74 and 82 High, 24 Deep
Right or Left Hand, On Glides or Feet*
FF Left, Door Right in 50 High on
Glides Shown

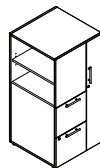

FF Wardrobe Tower w/ Open Side
50, 66, 74 and 82 High, 24 Deep
Right or Left Hand, On Glides or Feet*
FF Left, Door Right in 50 High on
Glides Shown

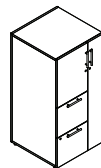

FF Wardrobe Tower w/ Cupboard
50, 66, 74 and 82 High, 24 Deep
Right or Left Hand, On Glides or Feet*
FF Left, Door Right in 50 High on
Glides Shown

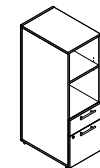

BF Pedestal Tower w/ Open Front
50, 66, 74 and 82 High, 24 Deep
On Glides or Feet*
50 High on Glides Shown

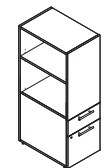

BF Pedestal Tower w/ Open Side
50, 66, 74 and 85 High, 24 Deep
Open Left or Open Right,
On Glides or Feet*
Open Left in 50H on Glides Shown

*Units on feet available up to 66" H

42" and Higher Floor Storage

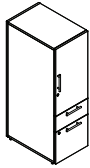

BF Pedestal Tower w/ Cupboard
50, 66, 74, 85 High, 24 Deep
Left or Right Hinge, On Glides or Feet
Right-Hinge in 50 High on Glides Shown



BBF Pedestal Tower w/ Open Front
50, 66 and 82 High, 24 Deep
On Glides or Feet
50 High on Glides Shown

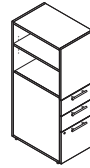

BBF Pedestal Tower w/ Open Side
50, 66, 74 and 85 High, 24 Deep
Open Left or Open Right,
On Glides or Feet
Open Left in 50H on Glides Shown

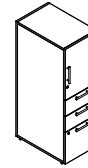

BBF Pedestal Tower w/ Cupboard
50, 66, 74, 85 High, 24 Deep
Left or Right Hinge
On Glides or Feet
Right-Hinge in 66 High on Glides Shown

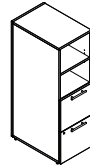

FF Pedestal Tower w/ Open Front
50, 66, 74 and 82 High, 24 Deep
On Glides or Feet
50 High on Glides Shown

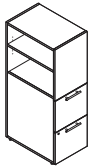

FF Pedestal Tower w/ Open Side
50, 66, 74 and 85 High, 24 Deep
Open Left or Open Right,
On Glides or Feet
Open Left in 50H on Glides Shown

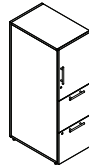

FF Pedestal Tower w/ Cupboard
50, 66, 74, 85 High, 24 Deep
Left or Right Hinge
On Glides or Feet
Right-Hinge in 50 High on Glides Shown

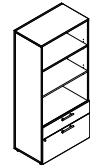

BF Lateral Bookcase
66, 74 and 82 High, 30 and 36 Widths
18 and 24 Depths
On Glides or Feet
66 High on Glides Shown

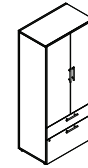

BF Lateral w/ Cabinet Doors
66, 74 and 82 High, 30 and 36 Widths
18 and 24 Depths
On Glides or Feet
66 High on Glides Shown

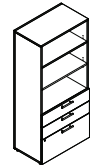

BBF Lateral Bookcase
66, 74 and 82 High, 30 and 36 Widths
18 and 24 Depths
With or Without Divider, On Glides or Feet
66 High on Glides Shown

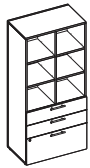

BBF Lateral Bookcase w/ Divider
42, 50, 66, 74 and 82 High,
30, 36 and 42 Widths, 18 Deep
On Glides or Feet
66 High on Glides Shown

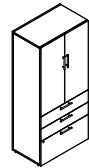

BBF Lateral w/ Cabinet Doors
66, 74 and 82 High, 30 and 36 Widths
18 and 24 Depths
On Glides or Feet
66 High on Glides Shown

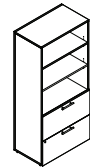

FF Lateral Bookcase
66, 74 and 82 High
30 and 36 Widths, 18 and 24 Depths
With or Without Divider, On Glides or Feet
66 High on Glides Shown

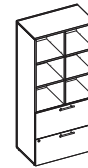

FF Lateral Bookcase w/ Divider
66, 74 and 82 High,
30, 36 and 42 Widths, 18 Deep
On Glides or Feet
66 High on Glides Shown

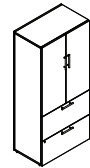

FF Lateral w/ Cabinet Doors
66, 74 and 82 High, 30 and 36 Widths
18 and 24 Depths
On Glides or Feet
66 High on Glides Shown

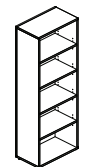

Floor Bookcase
42, 50, 66 and 74 High
30 and 36 Widths, 14 Deep
On Glides or Feet
66 High on Glides Shown

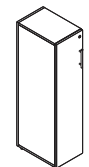

Single Door Locker
42, 50, 66 and 74 High,
12 Wide, 18 and 24 Depths
On Glides or Feet
50 High on Glides Shown



Double Door Locker
42 and 50 High,
12 Wide, 18 and 24 Depths
On Glides or Feet
50 High on Glides Shown

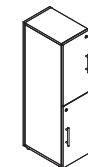

Double Door Lockers w/ Opposite Doors
42 and 50 High,
12 Wide, 18 and 24 Depths
On Glides or Feet
50 High on Glides Shown

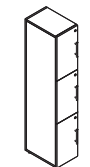

Triple Door Locker
66 and 74 High,
12 Wide, 18 and 24 Depths
On Glides or Feet
66 High on Glides Shown

Dry Planters and Stack-On Storage for Calibrate

DRY PLANTERS

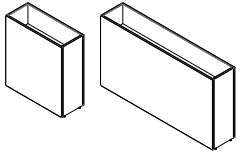

Stand Alone Dry Planter
 34", 42" and 50" High
 30", 36", 42", 48", 54" and 60" Widths
 12", 18" and 24" Deep

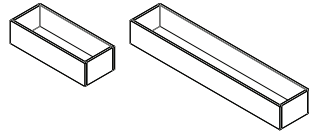

Stack-On Dry Planter
 8" High
 30", 36", 42", 48", 54" and 60" Widths
 12", 18" and 24" Deep

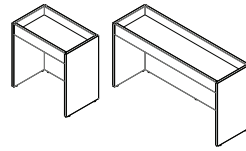

Single Wrap Dry Planter
 34" and 50" High
 30", 36", 42", 48", 54", 60", 66",
 72", 78" and 84" Widths
 18" and 24" Deep

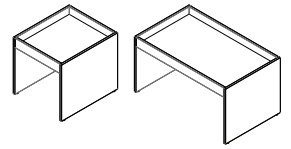

Double Wrap Dry Planter
 34" and 50" High
 30", 36", 42", 48", 54", 60", 66",
 72", 78" and 84" Widths
 36" and 48" Deep

STACK-ON STORAGE

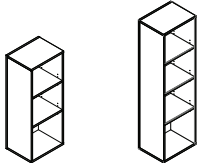

Stack-On Bookcase
 50, 58, 66 and 74 High
 18, 30 and 36 Widths, 14 Deep

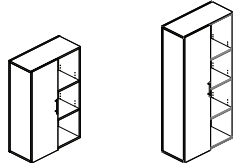

Stack-On Bookcase w/ Sliding Door
 50, 58, 66 and 74 High
 30, 36 and 42 Widths, 14 Deep, Left or Right Hand
Left Side Lock Sliding Door Shown

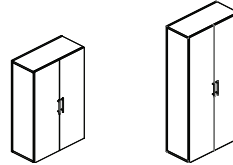

Stack-On Two Door Cabinet
 50, 58, 66 and 74 High
 18, 30 and 36 Widths, 14 Deep

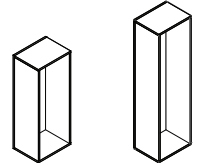

Stack-On Wardrobe
 50, 58, 66 and 74 High, 18 Wide, 14 Deep

Hutches for Calibrate

HUTCHES

Open Hutches

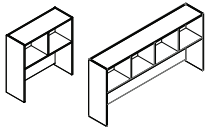

37" High Single Open Hutch
36 - 96 Widths
42 and 72 Widths Shown

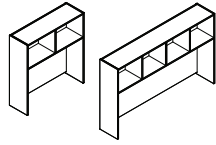

45" High Single Open Hutch
36 - 96 Widths
42 and 72 Widths Shown

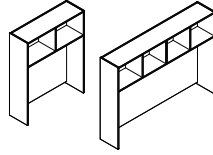

53" High Single Open Hutch
36 - 96 Widths
42 and 72 Widths Shown

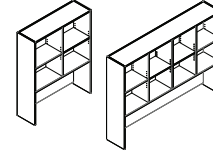

53" High Double Open Hutch
36 - 78 Widths
42 and 72 Widths Shown

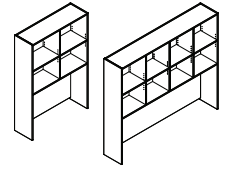

61" High Double Open Hutch
36 - 78 Widths
42 and 72 Widths Shown

Hutches with Cabinet Doors

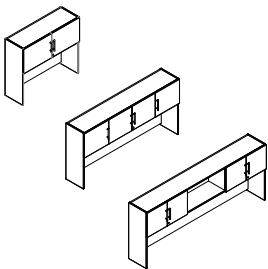

37" High Single Hutch w/
Cabinet Doors
Laminate or Framed Doors
36 - 96 Widths
Laminate in 42, 72 and 90 Widths Shown

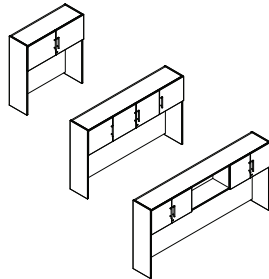

45" High Single Hutch w/
Cabinet Doors
Laminate or Framed Doors
36 - 96 Widths
Laminate in 42, 72 and 90 Widths Shown

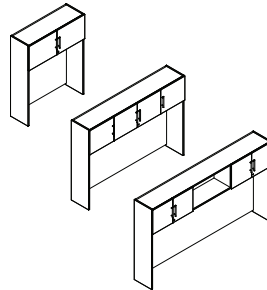

53" High Single Hutch w/
Cabinet Doors
Laminate or Framed Doors
36 - 96 Widths
Laminate in 42, 72 and 90 Widths Shown

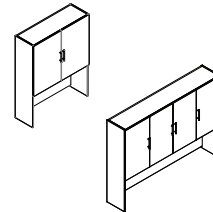

53" High Double Hutch w/
Cabinet Doors
Laminate or Framed Doors
36 - 78 Widths
Laminate in 42 and 72 Widths Shown

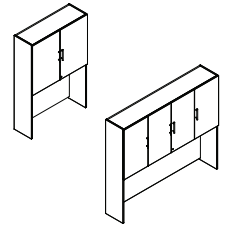

61" High Double Hutch w/
Cabinet Doors
Laminate or Framed Doors
36 - 78 Widths
Laminate in 42 and 72 Widths Shown

Hutches with Sliding Doors

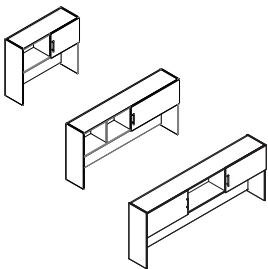

37" High Single Hutch w/
Sliding Doors
Laminate or Framed Sliding Doors
Left or Right Hand
36 - 96 Widths
Laminate Right Side Lock Sliding Doors in
42, 72 and 90 Widths Shown

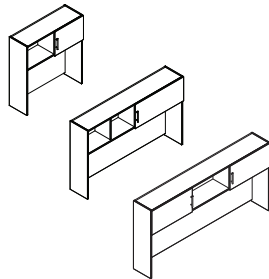

45" High Single Hutch w/
Sliding Doors
Laminate or Framed Sliding Doors
Left or Right Hand
36 - 96 Widths
Laminate Right Side Lock Sliding Doors in
42, 72 and 90 Widths Shown

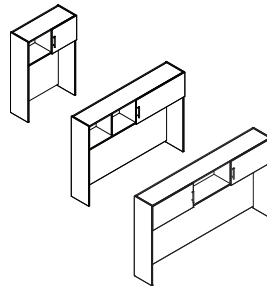

53" High Single Hutch w/
Sliding Doors
Laminate or Framed Sliding Doors
Left or Right Hand
36 - 96 Widths
Laminate Right Side Lock Sliding Doors in
42, 72 and 90 Widths Shown

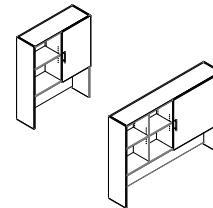

53" High Double Hutch w/
Sliding Doors
Laminate or Framed Sliding Doors
Left or Right Hand
36 - 78 Widths
Laminate Right Side Lock Sliding Doors in
42 and 72 Widths Shown

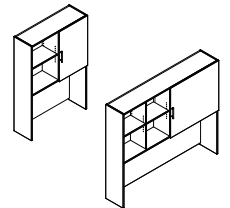

61" High Double Hutch w/
Sliding Doors
Laminate or Framed Sliding Doors
Left or Right Hand
36 - 78 Widths
Laminate Right Side Lock Sliding Doors in
42 and 72 Widths Shown

Tackboards and Miscellaneous Accessories for Calibrate

TACK BOARDS



Vertical Tackboard Wall Mount
53 - 61 High, 24 - 36 Widths

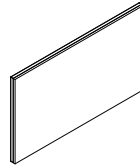
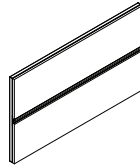

Tackboard Wall Mount
20, 28 and 35 High, 36 - 96 Widths
With or Without Tool Rail
Left Shown with Tool Rail

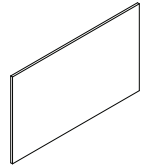

Tackboard Hutch Mount
20, 28 and 35 High, 36 - 96 Widths
With or Without Tool Rail
Left Shown with Tool Rail

MISCELLANEOUS ACCESSORIES

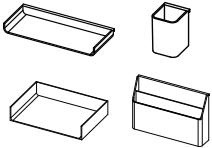

Paper Flow Elements

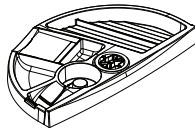

Spin Out Drawers

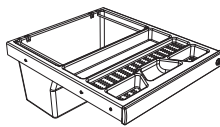

Pelican Drawers

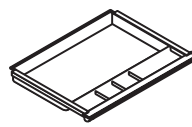

Pencil Drawer

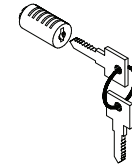

Key Alike Kit



Digital Locks

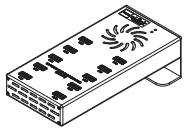

Digital Lock Charging Units

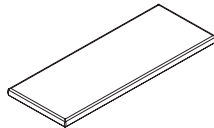

Cushion for Credenza
24 - 72 Widths

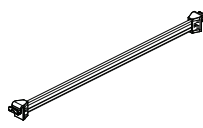

File Bars for Drawers

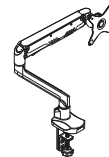

Monitor Arms
Single or Dual

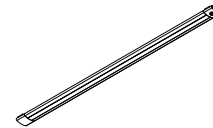

Overhead LED Task Light

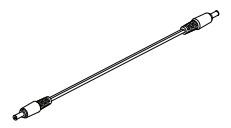

Overhead LED Task Light
Jumper Cable



LED Desk Lamp
Clamp, Short Arm or Desk Base
Clamp Base Shown

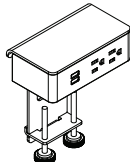

Ashley Duo
Clamp or Under Mount
Clamp Mount Shown

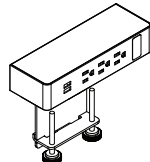

Ashley Trio
Clamp or Under Mount
Clamp Mount Shown

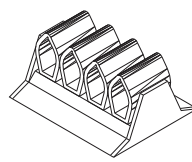

Cable Grip



Cord Manager for Tapered Leg

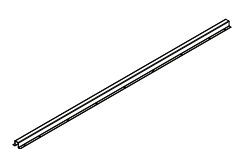

U-Channel

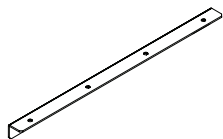

Worksurface Support Bracket



Panel Support Bracket

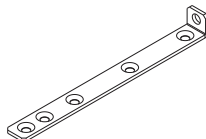

Hutch Wall Bracket

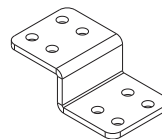

Z-Bracket



Tasklight Wire Manager for
Tackboards

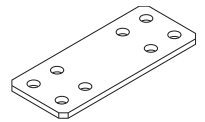

Flat Plate

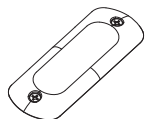

Flat Plate Cover

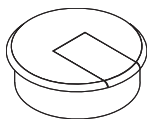

Grommet Hole Covers

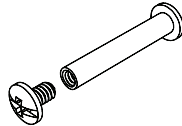

Ganging Bolts

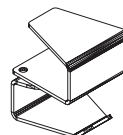

Bag Hook

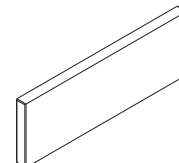

End Panel Riser

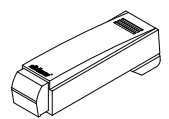

Soft Close Mechanism for
Hinged Door

Upholstery Fabric Options

UPHOLSTERY OPTIONS

Name	Grade
Durdle	A
Medley	A
Mirador	A
Palette	A
Terrain	A
Wellesley Polyurethane	A
Zagger	A
Beehave	B
Gem	B
Stamper	B
Blazer	D

Performance Alta™

Frock	B
Mirage	B
Prospect	B
Sway	B

CF Stinson Alliance Upholstery

Charlotte	D
Fleck	D
Lateral	D
Flanders	E
Hopsack	E
Outlander	E
Square One	E

Mayer Alliance Upholstery

Rumba	B
Fedora	C
Havana	C
Sydney	C
Channel	D
Engrave	D
Haven	D
Legacy	D

Momentum Alliance Program

Bobby	B
Grid	B
Origin	B
Odyssey	C
Tradition	C
Canter	D
Cover Cloth	D
Point	D
Beta	E
Boom II	E
Faux Felt	E

Note: All AIS alta upholstery orders will have alta application as a standard feature. Alta enables virtually any textile to withstand the rigors of real life without leaving a mark. Alta improves repellency to oil and water based stains, is easy to clean and can enhance physical properties of the fibers. The technology is permanent and imperceptible to the eye and hand. To Clean: Blot with a dry towel. If residue remains, flush with warm water. Learn more at applied-textiles.com

C.O.M. Fabric Policy

- Please view all pre-approved COMs here: <https://www.ais-inc.com/resources/fabrics-and-finishes/pre-approved-coms>
- It is mandatory that you work directly with your AIS Customer Service Representative for all COM related testing and orders. They will provide all necessary forms to you, as well as work with you with regard to sending in correct yardage and where to send it, along with necessary RA# or #s. Please note an RA must be submitted along with the fabric for testing, as well as an RA created for an actual order.
- Customer Service must be advised as to the width of the fabric rolls being supplied (54"W or 60"W). Customer Service must also be advised if the fabric has a backer.
- Yardage required for the job must be calculated by an AIS Customer Service Rep.
- Once AIS has approved the COM fabric, a fabric sample needs to be marked by the dealer with "Front", "Top", and "Bottom", to be sure fabric is applied correctly. The fabric sample then needs to be attached to a COM Fabric Dealer Form and forwarded to AIS Customer Service. [The COM Fabric Dealer Form may be downloaded or printed here.](#)
- Fabrics may be discontinued or obsolete without notice.
- Contact AIS Customer Service with any questions regarding fabric availability.
- All directional fabric will be railroaded.

Tackboard Fabric Options

VERTICAL SURFACE FABRICS

Name	Grade
Amaze	A
Avenue	A
Cape Cod	A
Engage	A
Mirador	A
New England	A
Rainfall	A
Simplicity	A
Theory	A
Twizzle	A
Lido	B
Marin	B
Nature	B
Off the Grid	B
Purpose	B
Spinel	B
Sprite	B

Note: 66" & 72" wide screens – if applying directional fabrics they will need to be railroaded for application. If using a COM fabric that is 54" wide, any screen over 48" wide would need to have the fabric railroaded as well.

C.O.M. Fabric Policy

- It is mandatory that you work directly with your AIS Customer Service Representative for all COM related testing and orders. They will provide all necessary forms to you, as well as work with you with regard to sending in correct yardage and where to send it, along with necessary RA# or #s. Please note an RA must be submitted along with the fabric for testing, as well as an RA created for an actual order.
- **Please Note:** A three to five yard sample is required for testing and approval for use on all monolithic panel systems. A one yard sample is required for testing and approval on Divi Insert Tiles, Matrix Tiles, flipper doors and tackboards. We may be able to test upholstery fabrics with a swatch, your Customer Service Representative will advise based on the fabric being tested; otherwise a 1 yard sample must be submitted for testing. Results take 48 - 72 hours.
- Customer Service must be advised as to the width of the fabric rolls being supplied (54"W or 60"W). Customer Service must also be advised if the fabric has a backer.
- Yardage required for the job must be calculated by an AIS Customer Service Rep.
- Once AIS has approved the COM fabric, a fabric sample needs to be marked by the dealer with "Front", "Top", and "Bottom", to be sure fabric is applied correctly. The fabric sample then needs to be attached to a COM Fabric Dealer Form and forwarded to AIS Customer Service. [The COM Fabric Dealer Form may be downloaded or printed here.](#)
- Fabrics may be discontinued or obsolete without notice.
- Contact AIS Customer Service with any questions regarding fabric availability.
- All directional fabric will be railroaded.

Laminate and Paint Options

CALIBRATE PAINT OPTIONS

Name	Color Code	Grade
Black	BK	A
Chalk	CK	A
Dark Tone	DT	A
Grey Value 1	GV1	A
Innertone	HT	A
Light Tone	LT	A
Medium Tone	MT	A
Metallic Silver	MS	A
Satin White	SW	A
Warm Brown	WB	A
Champagne Metallic	CHM	B
Dark Grey Metallic	DGM	B
Flint Grey Metallic	FGM	B
Light Grey	LG	B
Tan Value 1	TV1	B
Antique Gold	AG	C
Graphite Sky	GS	C
Burnt Orange	BO	C
Brown	BR	C
Steel Blue	SB	C
Baltic Blue	BB	C
Ruby Red	RR	C
Kelly Green	KG	C

Calibrate paint options can be used on any paintable surface with the exception of Height Adjustable Table Desk legs. Paint options available for Height Adjustable Table Legs are indicated by an * next to the paint name and are graded as A.

LAMINATE OPTIONS

Name	Grade
Absolute Acajou	A
Aimtoo Savatre	A
Black	A
Brazilwood	A
Chalk	A
Corporate Walnut	A
Dark Rum Cherry	A
Field Elm	A
Grand Cherry	A
Grey Elm	A
Landmark	A
Leave Likatre	A
Linen	A
Looks Likatre	A
Maritime Dune	A
Midwest Maple	A
Neo Walnut	A
Phantom Ecrú	A
Phantom Pearl	A
Storm	A
Summer Drops	A
True White	A
Trytoo Savatre	A
White Chocolate	A

Laminate options apply to worksurfaces, body/case, desk shell bases, modesties and doors/drawers. Matching edgeband available for all Calibrate laminate options.

Custom Paints

- Extended lead-time will apply.
- Any color not shown on Quick Ship, Standard Grade A or Grade B will be considered custom.
- A \$450 net paint match fee will be assessed following receipt of (2) 5"x5" samples of paint being matched. Additionally, Grade B paint-charges will be applied to all applicable products on the order.
- **Important Note:** Most paint match pricing can be covered by the Grade B up-charge in the catalog, however the final pricing can only be determined after the paint is matched and a product list is provided to AIS customer service. An additional fee may apply based on job size and paint color.

Calibrate Product Details

General Construction Details

- Worksurfaces are 1 1/8" thick, thermally fused laminate with matching edgeband. For available finishes please refer to Finishes section.
- High Pressure laminate options are available as a special, please note we are not able to offer matching edgebands for High Pressure laminates.
- Storage elements have 3/4" thick case construction with 1mm edge.
- Laminate drawer and door faces are 3/4" thick.
- 2mm edges available on worksurfaces and reverse knife edge on limited surfaces. See Product Detail: Edge Profile Details for examples.
- Leveling feet are adjustable up to 1" for all floor supported components.
- Units are finished all over, including the backs.
- Shelves will match body selection
- Laminate patterns such as grain or geometric shapes do not "match" face to face. However this is not noticeable on most laminate options with the exception of natural looking woods where cathedrals appear. AIS cannot guarantee that the woodgrain will match up on the different parts of the same surface.
- AIS recommends the use of mouse pads to protect longevity and integrity of worksurfaces.

Handle Options

- Four handle options are available:
 1. Bar Pull (in Brushed Nickel)
 2. Loop Pull (in Brushed Nickel)
 3. Rectangular Pull (in Bright Silver)
 4. L Pull (in Black, Metallic Silver or White)
- Symbols default with the bar pull but can be adjusted while applying your finishes.
- The handle hole spread is 5" if you wish to supply your own handles.
- Please see Product Detail: Drawer and Handles Guide for handle examples.

Assembly Details

- Desk shells, bridges and returns ship flat and must be installed in the field as shown. Storage elements ship fully assembled.
- Adjustable shelves are adjustable in 32mm increments.
- Easy assembly using CAM and PIN construction allows ease of disassembly.
- Credenzas are modular and units ganged together in the field.
- Supporting hardware for seam connections are included with returns and bridge pieces.

Desk Shells

- Desk shells have 5 pre-configured options. If another desking option is needed alternatives can be created using worksurfaces and full laminate support end panels which provide numerous options not shown.
- Desk shell depths are 24", 30" and 36" deep and widths run from 36" to 96" wide.
- Storage combinations should be specified as partial depth on any desk shell with a modesty (18" deep storage units will also fit under anything with a modesty).
- When specifying the quarter height and half height desk shell modesties keep in mind if you required storage items and the desk is not against the wall then they will be visible from under the modesties.
- Desk shells with widths 72" or larger have a movable center support.
- Leveling feet adjustable up to 1" for Calibrate floor storage.
- Please see Product Detail: Desk Shell Installation for desk shell construction examples.
- Please see Product Detail: Full Laminate Support Panels and Full Laminate Support Panel Configurations for full laminate support panel (FLSP) configuration examples.

Returns

- Return shell comes with full height height modesty panel, one full depth end panel and supporting hardware for seam connection.
- Returns can be specified in conjunction with AIS desk shells or specified as a stand alone piece if you have a storage component on the open ended side. Returns can be tied together with a Calibrate surface to storage bracket.
- Please see Product Detail for "L desk" unit examples.

Bridges

- Full modesty flush option only (for bridges without the modesty a standard worksurface can be specified).
- Supporting hardware for seam connections are included.

Run-Off Worksurfaces

- All standard run-off's are designed to match the standard desk heights.
- Floating tops work in conjunction with the 21" high storage units.
- The units are offered as non-powered and powered. The power options will come standard with (4) power outlets, (1) convenience outlet, (2) 2.1 amp USB, (2) keystone jack locations and (2) cord pass throughs (7/8" diameter each).

D Tops

- D Tops come with leg and are only available in square or rounded options.
- D Tops are available with or without a modesty.

Height Adjustable Table Desks

- Available in 24" and 30" depths and widths run 42" to 96" wide.
- Height adjustable table desks can be specified with or without a modesty.
- Please see Product Detail: Height Adjustable Table Desk Range for information about the height adjustable table desk range.

Suspended Modesty

- Suspended modesties can be specified on the height adjustable table desks without fixed modesties.
- Units are 12" high and are offered in 24" to 78" widths. Please follow the details on suspended modesty pricing page for what width modesty goes with what height adjustable table desk.

Storage

- AIS offers a wide variety of storage options and configurations that will work with your office needs. For more details please see below.
- Full depth units come with counterweights except for units with cut-outs.
- Partial depth units do not have counterweights. These units should be specified in a manner in which they are secured by a worksurface or ganged together with another storage unit using the Calibrate surface to support bracket.
- Framed doors are a silver vinyl wrapping with frosted acrylic.
- 18" deep towers and pull-out towers include a coat hook.
- 24" deep towers include a coat rod for hangers.
- Filing offered is side-to-side as standard for pencil lateral and file laterals that are 24" deep as well as partial depth laterals (22" deep and 29" deep).
- Front to back filing is an option that can be purchased as an accessory and will ship separately.
- All storage symbols will show the bar pull, however in worksheet you can swap the handle out as an option to one of the other standard offerings.
- 18" deep pedestals have 12" deep x 12" wide box drawers. Please see Product Detail: Pedestal and Lateral Dimensions for example.
- 24" deep pedestals have 20" deep x 12" wide box drawers. Please see Product Detail: Pedestal and Lateral Dimensions for example.
- 30" deep pedestals have 20" deep x 12" wide box drawers. Please see Product Detail: Pedestal and Lateral Dimensions for example.
- Pencil trays are included in the BBF and BF pedestals.
- Shelving counts: 42" high units have 2 shelves; 50" and 66" high units have 3 shelves; 74" and 82" high units have 4 shelves.
- Feet on storage are silver.

Overheads and Hutches

- Available as wall mounted or as a surface mounted hutch.
- Tackboards are specified separately, they do not come with the hutches.
- Installation details: Hutches will be secured to the top of the desk shell with cam and bolts or with double sided tape and screws to the wall and the side units when available. Hutch Wall Brackets (C-XHWP) are required when hutch is offset from wall or when not ganged to an adjacent tower unit.
- Wall mounted items are secured using cleat mounts. Security screws need to run through the wall cleat to assure that overhead cannot dislodge.

Calibrate Product Details**Locks**

- Box/Box/Files (BBF) pedestals will only lock the file and the middle box drawer, not the top box.
- File/File (FF) pedestal locks will secure both drawers.
- For all lateral files, wardrobe and storage units the locks will secure the drawers/door for the entire unit.
- All drawers lock on 3, 4 and 5 drawer laterals.
- Units will come with 2 keys per lock.
- Key-alike options are available per storage unit, additional lock cores may be ordered (for an additional charge) to key-alike an entire office.
- Items with 2 or more locks per unit will be keyed alike.

Tackboards

- Tackboards are designed to work with your stations need, with or without storage.
- Tackboard fabric direction is vertical on 24" to 48" wide units and will run horizontally for 54" to 96" wide pieces.
- Please see Product Detail for examples of tackboard fabric direction.

Table Desks

- Table desks are offered with square or round corners and tapered legs only.
- Desk sizes range from 48" to 78" wide and 30" to 36" deep.
- If another leg option is needed, a standard top with one of the other post leg offerings can be specified.
- Table desks can be shared throughout the Calibrate line.

Calibrate Product Details

Edge Profile Details

Worksurfaces are 1 1/8" thick, thermally fused laminate with matching edgeband.

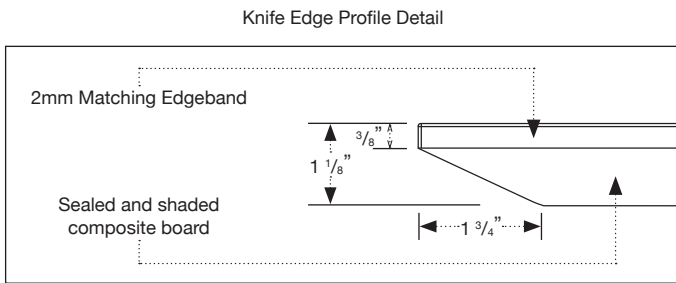
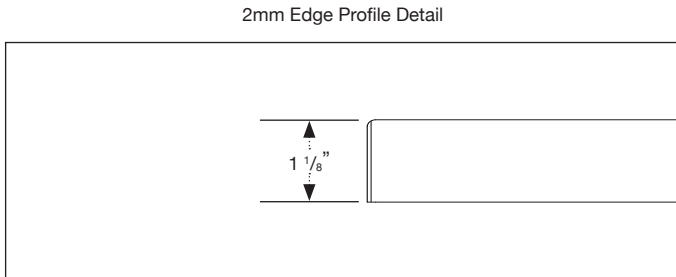

Height Adjustable Table Desk Range

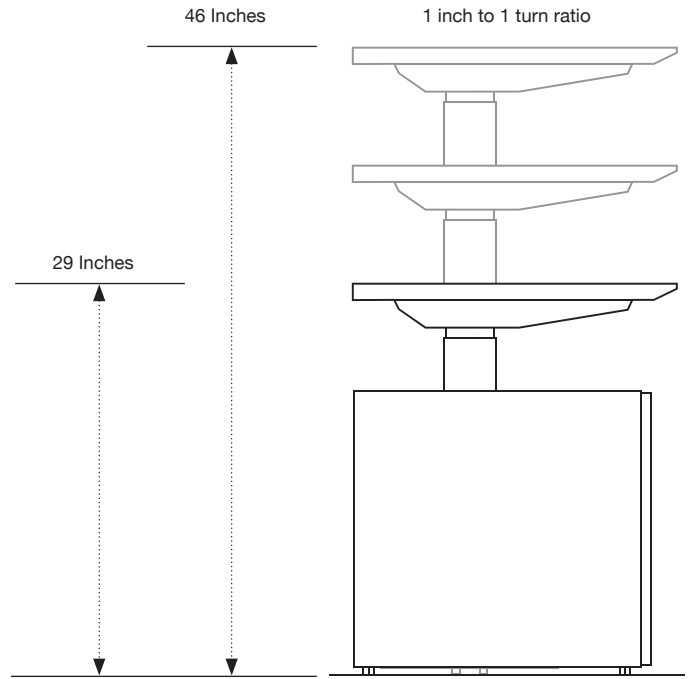

Wall Mounted Tackboard with Tool Rail

Tackboards assemble with or without an integrated tool rail mounted to front. Tackboards then attach with metal clips.

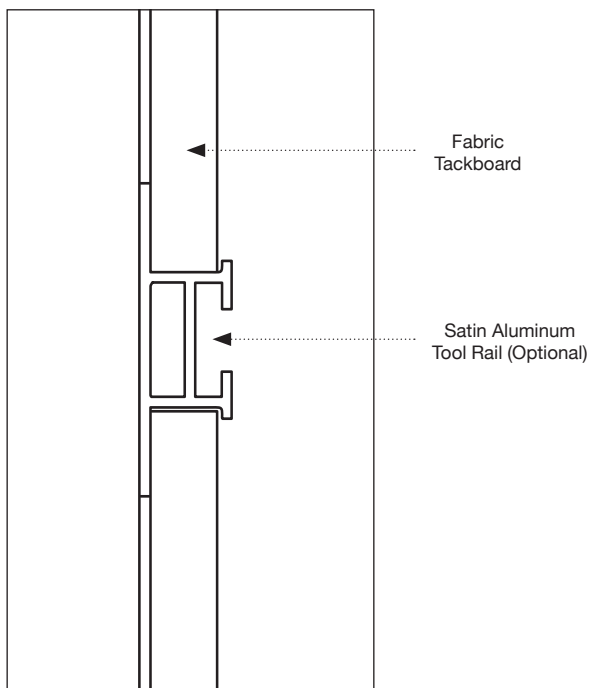

Drawer and Door Handles Guide

Four drawer and door handle options are offered:

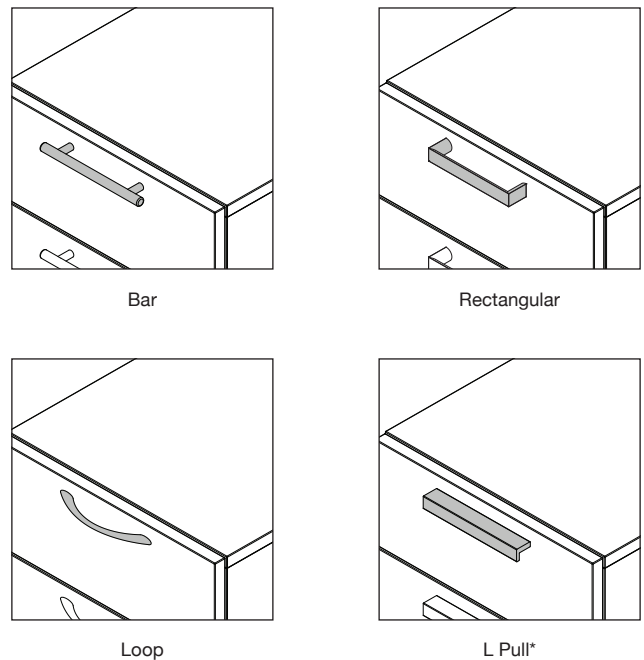

*L Pull handle is available in Black, Metallic Silver or Satin White.

Calibrate Product Details

Calibrate Heights

Calibrate heights shown using nominal dimensions. Please refer to Product Details: Actual vs. Nominal Heights to view actual vs nominal height charts.

21" High Floor Storage with Hutches and Hutch Mount Tackboards

Note: There is a 1" gap under tackboards for cables.

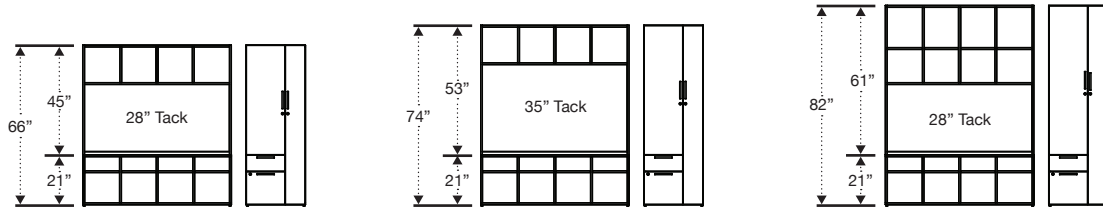

21" High Floor Storage with Wall Mounted Overheads, No Worksurfaces on Floor Storage and Wall Mounted Tackboards

Note: Tackboards sit flush to storage.

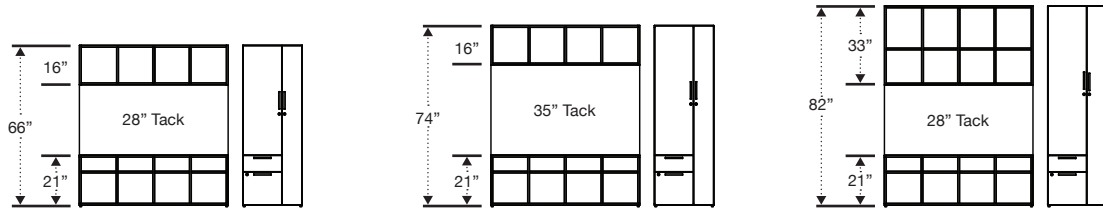

28" High Floor Storage with Hutches and Worksurfaces on Floor Storage

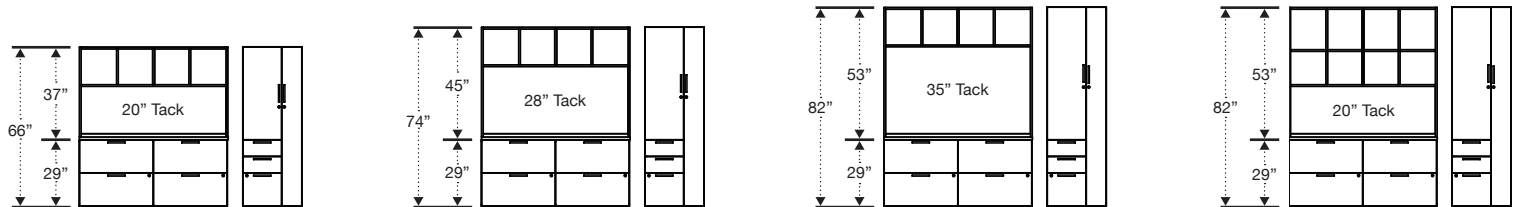

28" High Floor Storage with Wall Mounted Overheads, No Worksurfaces on Floor Storage

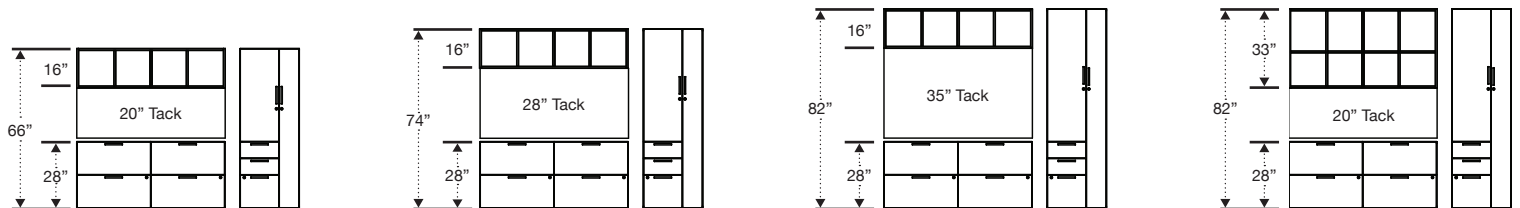

Calibrate Heights (Cont.)

Calibrate heights shown using nominal dimensions. Please refer to Product Details: Actual vs. Nominal Heights to view actual vs nominal height charts.

28" High Floor Storage with Wall Mounted Overheads and Worksurfaces on Floor Storage

Note: There is no gap above or below tackboard.

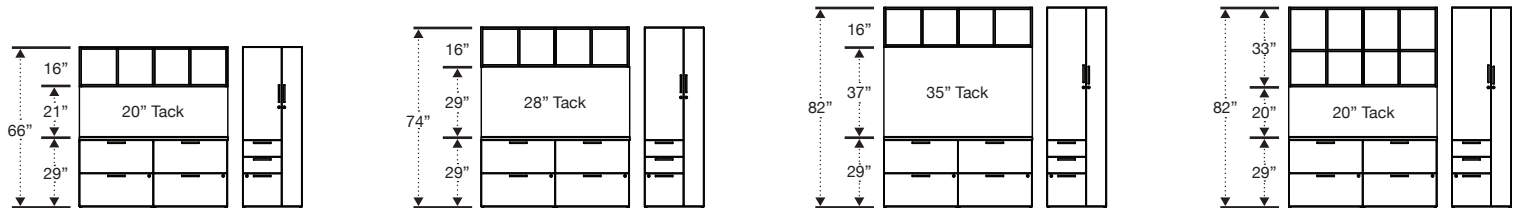

29" High Desk Shells with Hutches and Hutch Mount Tackboards

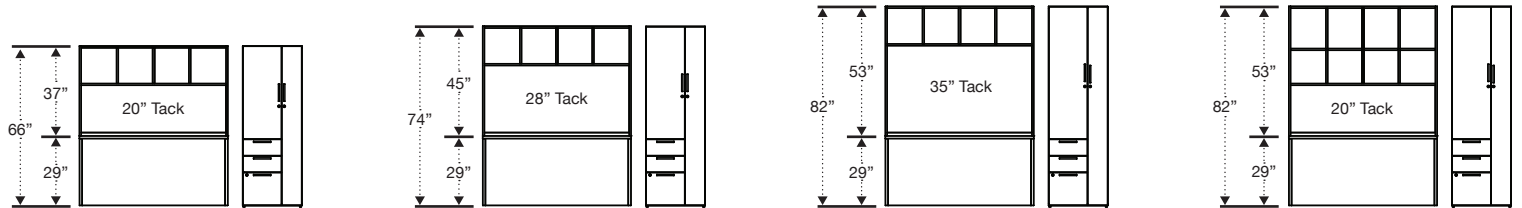

29" High Desk Shells with Wall Mounted Overhead

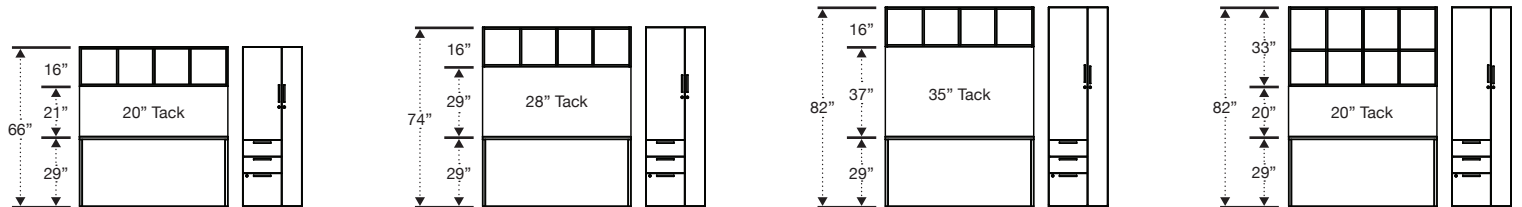

Floor Storage and Wall Mounted Overheads

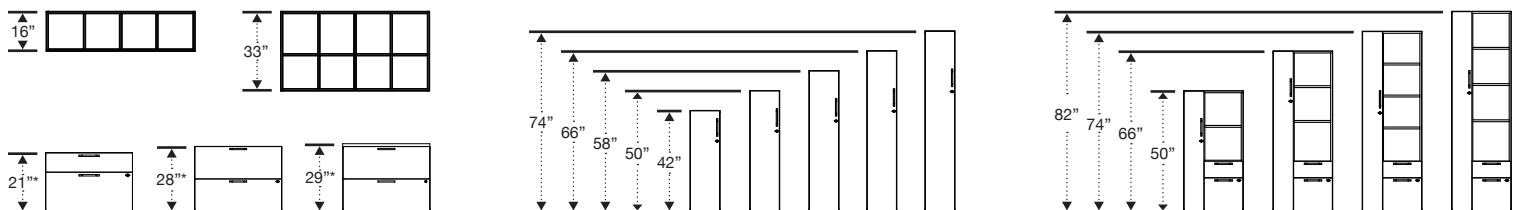

*Measurements shown include surface.

Calibrate Product Details

Actual vs Nominal Heights

Floor Units		Hutches and Stack		Towers	
Actual Heights	Nominal Height	Actual Heights	Nominal Height	Actual Heights	Nominal Height
20.714	21	8.31	8	41	42
27.438	28	36.286	37	49	50
28.64	29	44.286	45	57	58
		52.286	53 (Single)	64.963	66
		52.286	53 (Double)	72.963	74
		60.286	61	80.963	82

Base Unit and Hutch Combinations						
Base Unit Actual Height	Base Unit Nominal Height	Stack Unit Actual Heights	Stack Unit Nominal Height	Actual Combined	Nominal Combined	Tower Match
20.714	21	8.31	8 (Power Stack Shelf)	29.024	29	Matches 29 High
20.714	21	36.286	37 (Single)	57	N/A	N/A
20.714	21	44.286	45 (Single)	65	66	Matches 66 High
20.714	21	52.286	53 (Single)	73	74	Matches 74 High
20.714	21	52.286	53 (Double)	73	N/A	N/A
20.714	21	60.286	61	81	82	Matches 82 High
27.438	28	8.31	8	35.748	N/A	N/A
27.438	28	36.286	37	63.724	N/A	N/A
27.438	28	44.286	45	71.724	N/A	N/A
27.438	28	52.286	53	79.724	N/A	N/A
27.438	28	60.286	61	87.724	N/A	N/A
28.64	29	8.31	8	36.95	N/A	N/A
28.64	29	36.286	37	64.426	66	Matches 66 High
28.64	29	44.286	45	72.926	74	Matches 74 High
28.64	29	52.286	53 (Single)	80.926	N/A	N/A
28.64	29	52.286	53 (Double)	80.926	82	Matches 82 High
28.64	29	60.286	61	88.926	N/A	N/A

Wood Grain Direction

Grain direction runs vertical for all pieces except for the back of 48" wide cabinets, in which case it runs horizontal. Calibrate wood grain is always vertical on storage fronts and doors. Grains run vertically on items under 60" wide. Items over 60" wide have the grain will run horizontally.

Note: Wood grains do not "match" face to face. AIS cannot guarantee that the woodgrain will match up on the different parts of the same surface.

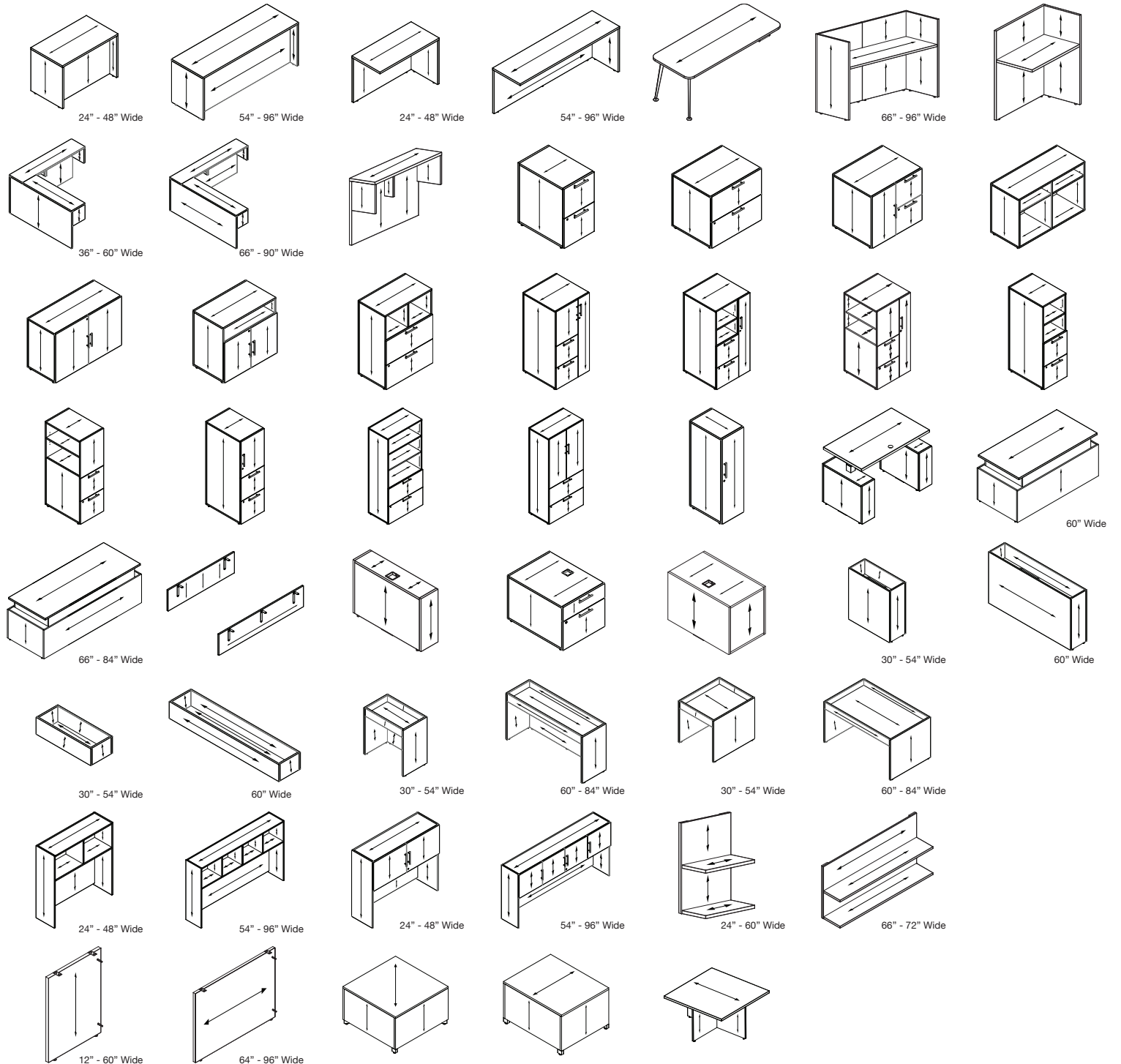

Calibrate Product Details

Tackboard Fabric Direction

Tackboard fabrics runs vertically on 24" - 48" width tackboards. Fabric runs horizontally on 54" - 96" width tackboards.

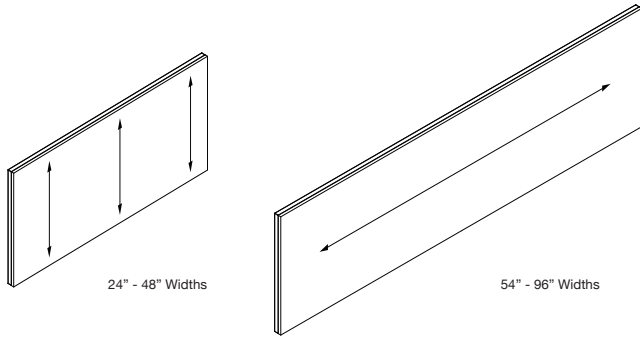

Cut-Outs

Surface with full depth storage with counterweight
Storage units do not need to be ganged together.

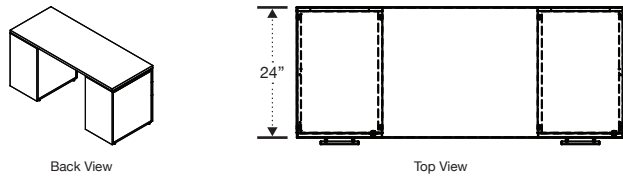

Desk shell with partial depth
Storage units must be attached to desk shell. Modesty access has a 5" opening. Bottom modesty measures approximately 13" from floor to access opening.

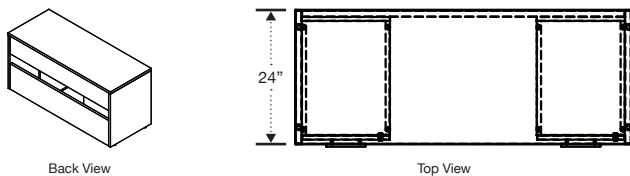

Surface with partial depth storage
Storage units must be ganged together.

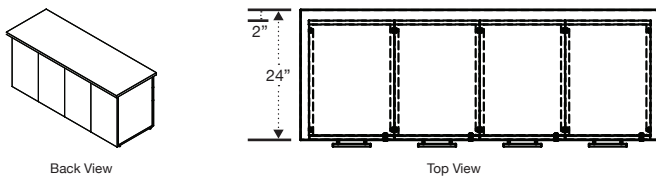

Grommet Locations for Desk Shells, Returns, Bridges & Reception

GROMMET OPTIONS

Option	Location	Desk Shell, Return, Bridges List	Height Adjustable Worksurface List
A	No Grommets	-	-
B	Location 1	+45	+38
C	Location 2	+45	+38
D	Location 3	+45	+38
E	Locations 2 and 3	-	+76
F	Locations 1, 2 and 3	-	+114
G	Locations 1 and 2	-	+76
H	Locations 1 and 3	-	+76

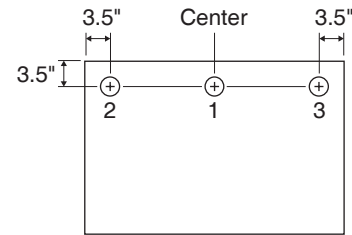

Note: Desk shells with recessed modesties feature grommets that are 8.33" from back edge to allow grommet to be on the inside of modesty.

RECEPTION GROMMET OPTIONS

Option	Location	Reception List
None	No Grommets	-
Center	Center	+45
Left	Left	+45
Right	Right	+45

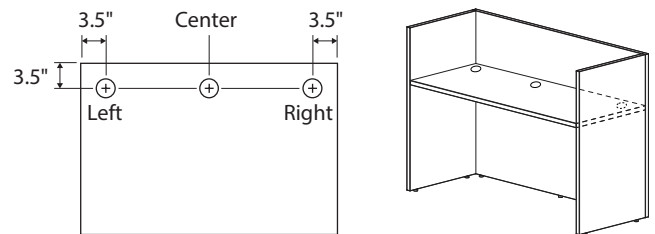

Desk Shell Installation

Desk shells, bridges and returns ship flat and must be installed in the field as shown. Storage elements ship fully assembled.

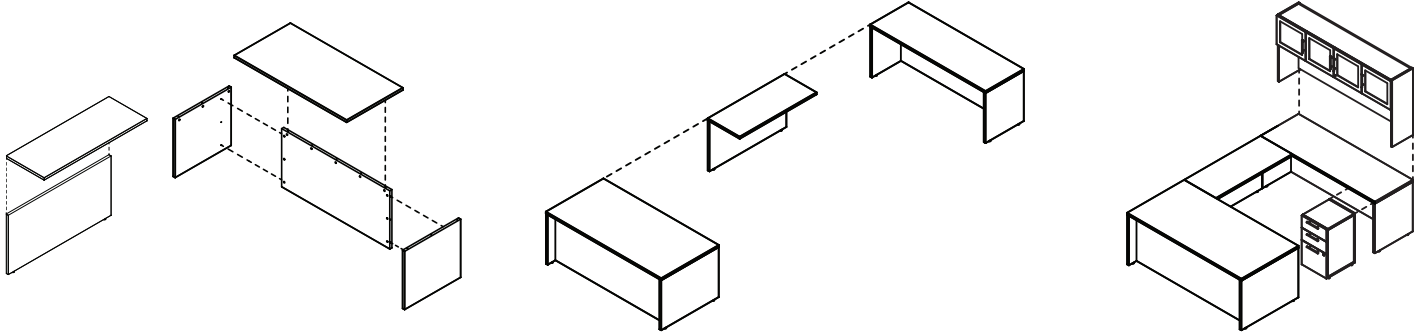

Pedestal and Lateral Dimensions

Pedestal Tower Depths and Widths:

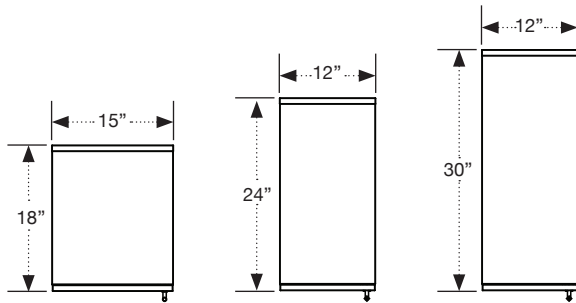

Lateral Tower Depths and Widths:

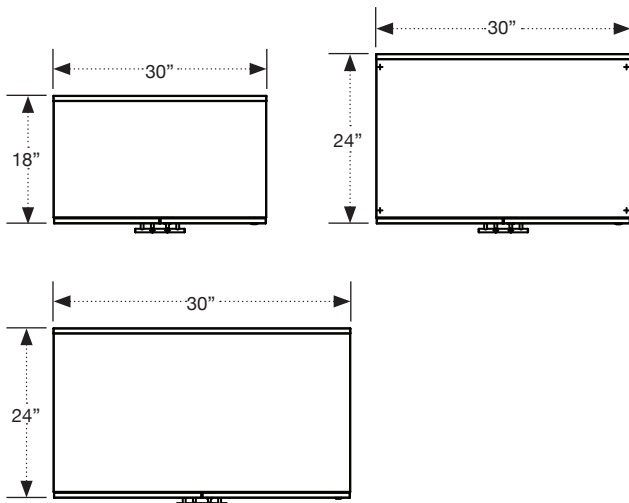

Calibrate Storage Feet vs Glides

Calibrate Storage on Feet

Calibrate Storage on Glides

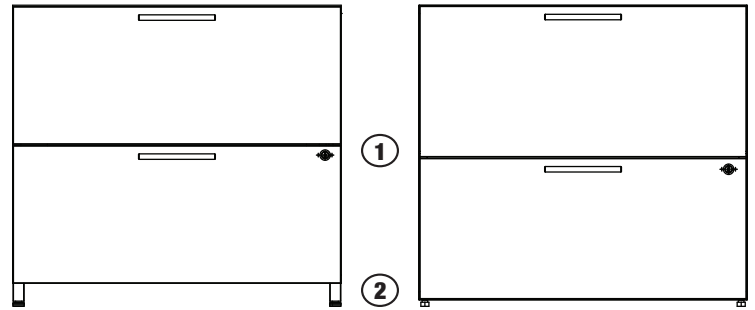

1. Calibrate Storage on Feet vs Calibrate Storage on Glides Drawer Height

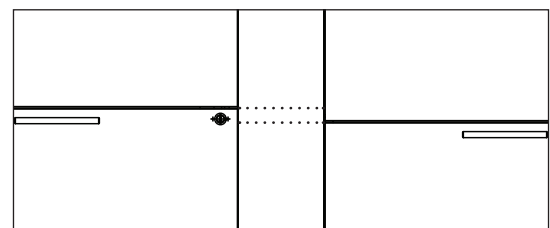

2. Calibrate Storage on Feet vs Calibrate Storage on Glides Height

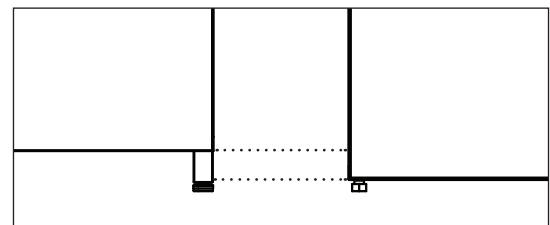

Calibrate Product Details

Filing Details

File Bar	Model Number	Dimension
A	RH-WFB10	8.39
B	RH-WFB16	14.39
C	RH-WFB12	12.125
D	RH-WFB19	19.46
E	RH-WFB26	25.77
F	RH-WFB32	31.77
G	RH-WFB38	37.77

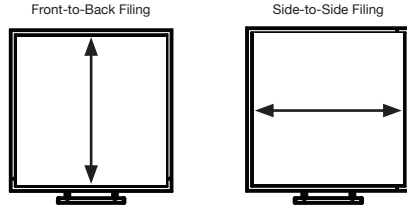

18" Deep File Drawers

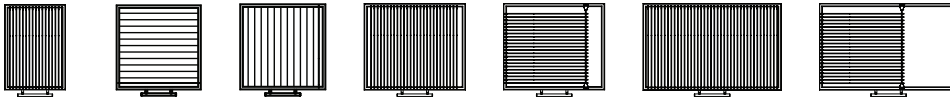

12 Wide Letter Side-to-Side File Bar Not Required
 16 Wide Letter Front-to-Back File Bar Not Required
 16 Wide Letter Side-to-Side File Bar Not Required
 18 Wide Letter Side-to-Side File Bar Not Required
 18 Wide Letter Front-to-Back w/ File Bar C (Not Included)
 24 Wide Letter Side-to-Side File Bar Not Required
 24 Wide Letter Front-to-Back w/ File Bar C (Not Included)

24" Deep File Drawers

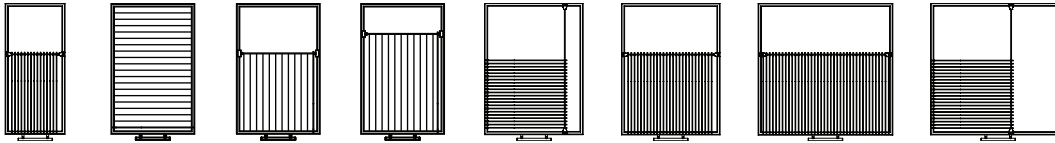

12 Wide Letter Side-to-Side w/ File Bar A (Included)
 16 Wide Letter Front-to-Back File Bar Not Required
 16 Wide Letter Side-to-Side w/ File Bar B (Not Included)
 16 Wide Legal Side-to-Side w/ File Bar B (Not Included)
 18 Wide Letter Front-to-Back w/ File Bar D (Not Included)
 18 Wide Letter Side-to-Side w/ File Bar C (Included)
 24 Wide Letter Side-to-Side w/ File Bar D (Included)
 24 Wide Letter Front-to-Back w/ File Bar D (Included)

30" Wide x 18" Deep File Drawers

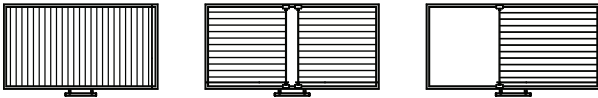

Letter Side-to-Side File Bar Not Required
 Letter Front-to-Back w/ File Bar C (Qty. 2) (Not Included)
 Legal Front-to-Back w/ File Bar C (Not Included)

36" Wide x 18" Deep File Drawers



Letter Side-to-Side File Bar Not Required
 Letter Front-to-Back w/ File Bar C (Qty. 4) (Not Included)
 Legal Front-to-Back w/ File Bar C (Qty. 2) (Not Included)
 Letter (Left), Legal (Right) Front-to-Back w/ File Bar C (Qty. 2) (Not Included)

42" Wide x 18" Deep File Drawers



Letter Side-to-Side File Bar Not Required
 Letter Front-to-Back w/ File Bar C (Qty. 4) (Not Included)
 Legal Front-to-Back w/ File Bar C (Qty. 2) (Not Included)
 Letter (Left), Legal (Right) Front-to-Back w/ File Bar C (Qty. 2) (Not Included)

Filing Details (Cont.)

File Bar	Model Number	Dimension
A	RH-WFB10	8.39
B	RH-WFB16	14.39
C	RH-WFB12	12.125
D	RH-WFB19	19.46
E	RH-WFB26	25.77
F	RH-WFB32	31.77
G	RH-WFB38	37.77

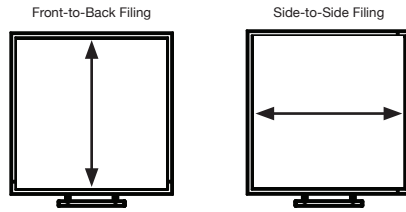

30" Wide x 24" Deep File Drawers

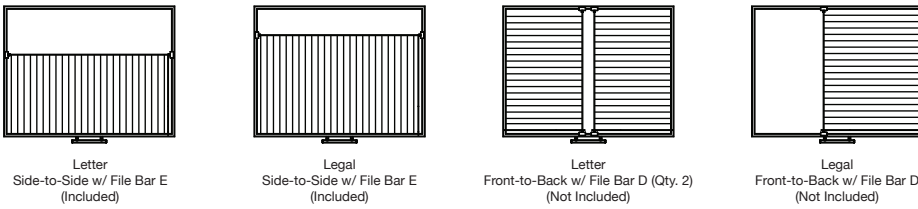

36" Wide x 24" Deep File Drawers

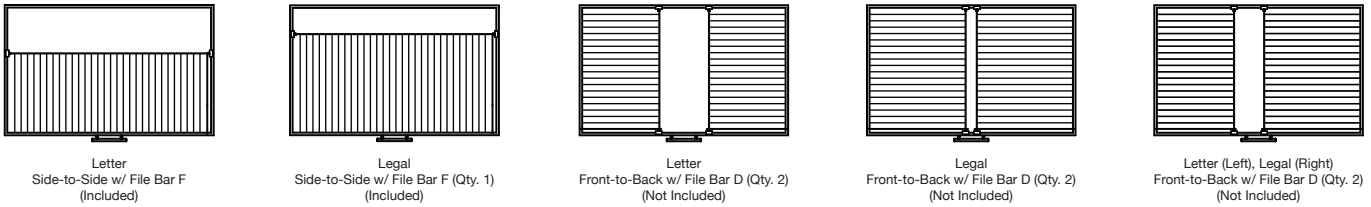

42" Wide x 24" Deep Laterals

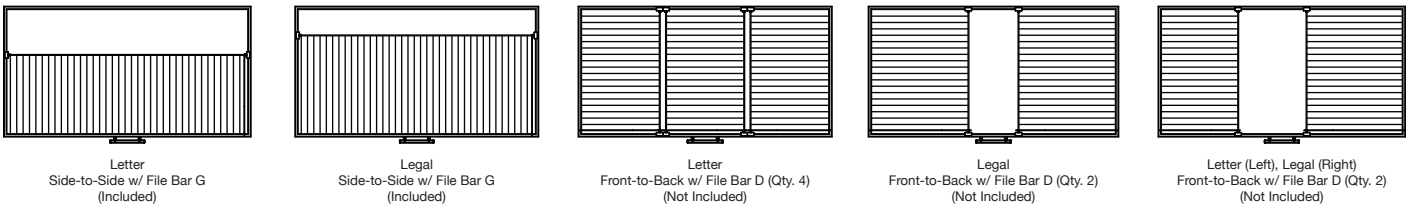

Calibrate Product Details

Run-Off Connections

Standard Run-Off Connection (Desk Shell with Run-Off)
Desk Shell with Flushed Modesty Shown

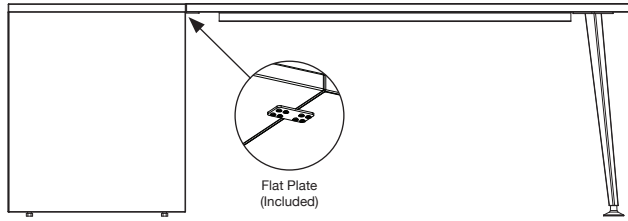

Standard Run-Off Connection (Desk Shell and Floor Bookcase with Run-Off)
Desk Shell with Flushed Modesty and 18" Deep Floor Bookcase Shown

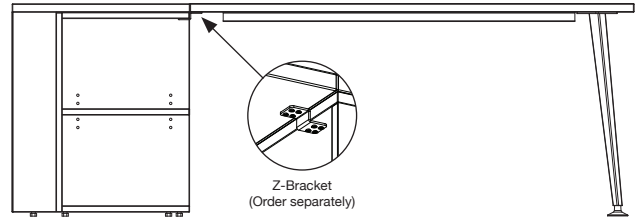

Floating Run-Off Surfaces

Floating Run-Off Surfaces are designed to be supported from 21" high storage elements. Run-off surfaces may be ordered with a powered unit that includes an access door with interior storage for devices with standard 15 amp NEMA outlets, (2) 2.1 amp USBs, (2) 1 1/4 diameter pass through grommets and (2) keystone style jack/device holes for data or HDMI jacks. Includes 15 amp overload switch with reset, surge protection. Cables may also be managed through this power unit from the desktop surface.



Side View

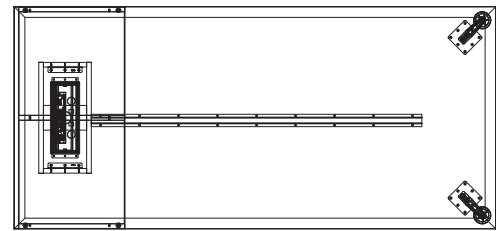

Top View

Run-Off Support

EXAMPLE 1 - STABLE

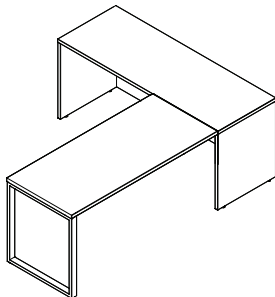

Run-Off and Table Desk Tops

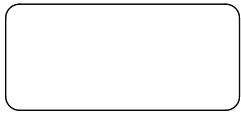

Radius Rectangular Top



Rectangular Top

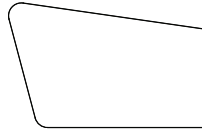

Blade Top (Left)

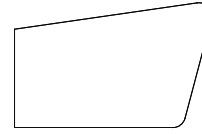

Blade Top (Right)

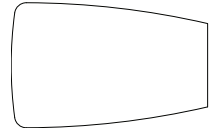

Wedge Top



D Top



Square Table Top

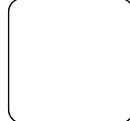

Round Corner Square Table Top

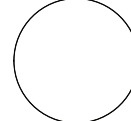

Round Table Top

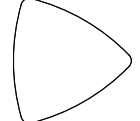

Triangle Table Top

Left - Right Handing Logic for Calibrate Series

Handing for Cabinet Doors:



Hinge-Left



Hinge-Right

Handing for Sliding Doors:

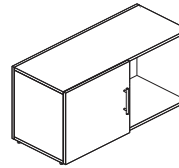

Left Side Lock

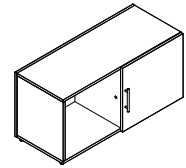

Right Side Lock

Handing for Shared Storage:

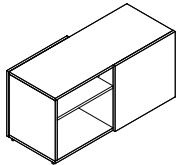

Open Left

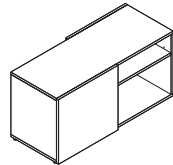

Open Right

Handing for Shared Storage:

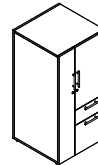

Wardrobe Left Hand

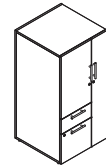

Wardrobe Right Hand

Handing for Side Access Storage:

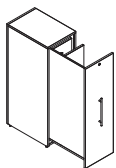

Left-Handed

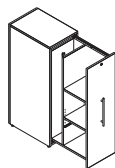

Right-Handed

Handing for Towers with Open Side:



Open Right, Place Left

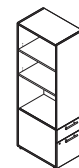

Open Left, Place Right

Calibrate Product Details

Calibrate Storage Functional Loads

CALIBRATE STORAGE FUNCTIONAL LOADS			
Description	Model Number	Top-to-Bottom Drawer Functional Load (lbs)	Total Functional Load (lbs)
BF Pedestal (18" Deep)	X-BFP18	5/30	35
BF Pedestal (22" Deep)	X-BFP22C	10/45	55
BF Pedestal (24" Deep)	X-BFP24	10/45	55
BF Pedestal on Feet (18" Deep)	C-BFP18	5/30	35
BF Pedestal on Feet (22" Deep)	C-BFP22	10/45	55
BF Pedestal on Feet (24" Deep)	C-BFP24	10/45	55
BF Pedestal on Casters (no cushion)	C-BFP18MNC	5/10	35
BF Pedestal on Casters (with cushion)	C-BFP18M	5/10	35
BF Lateral (30" Wide, 18" Deep)	X-PLAT2D3018	15/65	80
BF Lateral (36" Wide, 18" Deep)	X-PLAT2D3618	15/80	95
BF Lateral (42" Wide, 18" Deep)	X-PLAT2D4218	20/95	115
BF Lateral (30" Wide, 22" Deep)	X-PLAT2D3022C	20/105	125
BF Lateral (36" Wide, 22" Deep)	X-PLAT2D3622C	30/130	160
BF Lateral (42" Wide, 22" Deep)	X-PLAT2D4222C	35/155	190
BF Lateral (30" Wide, 24" Deep)	X-PLAT2D3024	20/105	125
BF Lateral (36" Wide, 24" Deep)	X-PLAT2D3624	30/130	160
BF Lateral (42" Wide, 24" Deep)	X-PLAT2D4224	35/155	190
BF Lateral on Feet (30" Wide, 18" Deep)	C-PLATJ2D30	15/65	80
BF Lateral on Feet (36" Wide, 18" Deep)	C-PLATJ2D36	15/80	95
BF Lateral on Feet (42" Wide, 18" Deep)	C-PLATJ2D42	20/95	115
BF Lateral on Feet (30" Wide, 22" Deep)	C-PLAT2D3022	20/105	125
BF Lateral on Feet (36" Wide, 22" Deep)	C-PLAT2D3622	30/130	160
BF Lateral on Feet (42" Wide, 22" Deep)	C-PLAT2D4222	35/155	190
BF Lateral on Feet (30" Wide, 24" Deep)	C-PLAT2D3024	20/105	125
BF Lateral on Feet (36" Wide, 24" Deep)	C-PLAT2D3624	30/130	160
BF Lateral on Feet (42" Wide, 24" Deep)	C-PLAT2D4224	35/155	190
Double Pencil Lateral (30" Wide)	X-PLAT2D30	30/130	160
Double Pencil Lateral (36" Wide)	X-PLAT2D36	30/160	190
Double Pencil Lateral (42" Wide)	X-PLAT2D42	40/190	230
Double Pencil Lateral on Feet (30" Wide)	C-DPLAT2D30	30/130	160
Double Pencil Lateral on Feet (36" Wide)	C-DPLAT2D36	30/160	190
Double Pencil Lateral on Feet (42" Wide)	C-DPLAT2D42	40/190	230

Calibrate Storage Functional Loads (Cont.)

CALIBRATE STORAGE FUNCTIONAL LOADS			
Description	Model Number	Top-to-Bottom Drawer Functional Load (lbs)	Total Functional Load (lbs)
BBF Pedestal (18" Deep)	X-BBFPFS18	10/10/30	50
BBF Pedestal (23" Deep)	X-BBFPFS23	10/10/45	65
BBF Pedestal (24" Deep)	X-BBFPFS24	10/10/45	65
BBF Pedestal (29" Deep)	X-BBFPFS29	10/10/45	65
BBF Pedestal (30" Deep)	X-BBFPFS30	10/10/45	65
BBF Pedestal on Feet (18" Deep)	C-BBFPFS18	10/10/30	50
BBF Pedestal on Feet (23" Deep)	C-BBFPFS23	10/10/45	65
BBF Pedestal on Feet (24" Deep)	C-BBFPFS24	10/10/45	65
BBF Pedestal on Feet (29" Deep)	C-BBFPFS29	10/10/45	65
BBF Pedestal on Feet (30" Deep)	C-BBFPFS30	10/10/45	65
FF Pedestal (18" Deep)	X-FFPFS18	30/30	60
FF Pedestal (23" Deep)	X-FFPFS23	45/45	90
FF Pedestal (24" Deep)	X-FFPFS24	45/45	90
FF Pedestal (29" Deep)	X-FFPFS29	45/45	90
FF Pedestal (30" Deep)	X-FFPFS30	45/45	90
FF Pedestal on Feet (18" Deep)	C-FFPFS18	30/30	60
FF Pedestal on Feet (23" Deep)	C-FFPFS23	45/45	90
FF Pedestal on Feet (24" Deep)	C-FFPFS24	45/45	90
FF Pedestal on Feet (29" Deep)	C-FFPFS29	45/45	90
FF Pedestal on Feet (30" Deep)	C-FFPFS30	45/45	90
BBF Lateral (30" Wide, 18" Deep)	X-BBFLAT3018	15/15/60	90
BBF Lateral (36" Wide, 18" Deep)	X-BBFLAT3618	15/15/80	110
BBF Lateral (42" Wide, 18" Deep)	X-BBFLAT4218	20/20/95	135
BBF Lateral (30" Wide, 23" Deep)	X-BBFLAT3023	20/20/105	145
BBF Lateral (36" Wide, 23" Deep)	X-BBFLAT3623	30/30/130	190
BBF Lateral (42" Wide, 23" Deep)	X-BBFLAT4223	35/35/155	225
BBF Lateral (30" Wide, 24" Deep)	X-BBFLAT3024	20/20/105	145
BBF Lateral (36" Wide, 24" Deep)	X-BBFLAT3624	30/30/130	190
BBF Lateral (42" Wide, 24" Deep)	X-BBFLAT4224	35/35/155	225
BBF Lateral (30" Wide, 29" Deep)	X-BBFLAT3029	20/20/105	145
BBF Lateral (36" Wide, 29" Deep)	X-BBFLAT3629	30/30/130	190
BBF Lateral (42" Wide, 29" Deep)	X-BBFLAT4229	35/35/155	225

Calibrate Product Details

Calibrate Storage Functional Loads (Cont.)

CALIBRATE STORAGE FUNCTIONAL LOADS			
Description	Model Number	Top-to-Bottom Drawer Functional Load (lbs)	Total Functional Load (lbs)
BBF Lateral on Feet (30" Wide, 18" Deep)	C-BBFLAT3018	15/15/60	90
BBF Lateral on Feet (36" Wide, 18" Deep)	C-BBFLAT3618	15/15/80	110
BBF Lateral on Feet (42" Wide, 18" Deep)	C-BBFLAT4218	20/20/95	135
BBF Lateral on Feet (30" Wide, 23" Deep)	C-BBFLAT3023	20/20/105	145
BBF Lateral on Feet (36" Wide, 23" Deep)	C-BBFLAT3623	30/30/130	190
BBF Lateral on Feet (42" Wide, 23" Deep)	C-BBFLAT4223	35/35/155	225
BBF Lateral on Feet (30" Wide, 24" Deep)	C-BBFLAT3024	20/20/105	145
BBF Lateral on Feet (36" Wide, 24" Deep)	C-BBFLAT3624	30/30/130	190
BBF Lateral on Feet (42" Wide, 24" Deep)	C-BBFLAT4224	35/35/155	225
BBF Lateral on Feet (30" Wide, 29" Deep)	C-BBFLAT3029	20/20/105	145
BBF Lateral on Feet (36" Wide, 29" Deep)	C-BBFLAT3629	30/30/130	190
BBF Lateral on Feet (42" Wide, 29" Deep)	C-BBFLAT4229	35/35/155	225
Two Drawer Lateral (30" Wide, 18" Deep)	X-LAT2DFS3018	65/65	130
Two Drawer Lateral (36" Wide, 18" Deep)	X-LAT2DFS3618	80/80	160
Two Drawer Lateral (42" Wide, 18" Deep)	X-LAT2DFS4218	95/95	190
Two Drawer Lateral (30" Wide, 23" Deep)	X-LAT2DFS3023	105/105	210
Two Drawer Lateral (36" Wide, 23" Deep)	X-LAT2DFS3623	130/130	260
Two Drawer Lateral (42" Wide, 23" Deep)	X-LAT2DFS4223	155/155	310
Two Drawer Lateral (30" Wide, 24" Deep)	X-LAT2DFS3024	105/105	210
Two Drawer Lateral (36" Wide, 24" Deep)	X-LAT2DFS3624	130/130	260
Two Drawer Lateral (42" Wide, 24" Deep)	X-LAT2DFS4224	155/155	310
Two Drawer Lateral (30" Wide, 29" Deep)	X-LAT2DFS3029	105/105	210
Two Drawer Lateral (36" Wide, 29" Deep)	X-LAT2DFS3629	130/130	260
Two Drawer Lateral (42" Wide, 29" Deep)	X-LAT2DFS4229	155/155	310
Two Drawer Lateral on Feet (30" Wide, 18" Deep)	C-LAT2D1830	65/65	130
Two Drawer Lateral on Feet (36" Wide, 18" Deep)	C-LAT2D1836	80/80	160
Two Drawer Lateral on Feet (42" Wide, 18" Deep)	C-LAT2D1842	95/95	190
Two Drawer Lateral on Feet (30" Wide, 23" Deep)	C-LAT2DFS3023	105/105	210
Two Drawer Lateral on Feet (36" Wide, 23" Deep)	C-LAT2DFS3623	130/130	260
Two Drawer Lateral on Feet (42" Wide, 23" Deep)	C-LAT2DFS4223	155/155	310
Two Drawer Lateral on Feet (30" Wide, 24" Deep)	C-LAT2D2430	105/105	210
Two Drawer Lateral on Feet (36" Wide, 24" Deep)	C-LAT2D2436	130/130	260
Two Drawer Lateral on Feet (42" Wide, 24" Deep)	C-LAT2D2442	155/155	310
Two Drawer Lateral on Feet (30" Wide, 29" Deep)	C-LAT2DFS3029	105/105	210
Two Drawer Lateral on Feet (36" Wide, 29" Deep)	C-LAT2DFS3629	130/130	260
Two Drawer Lateral on Feet (42" Wide, 29" Deep)	C-LAT2DFS4229	155/155	310

Calibrate Reception Installation

Reception stack-on units attached via combination of double sided tape and screws. When using reception desk shells and reception countertop, reception desk shells must always be greater than or equal to in width to reception countertop. When mounted on reception desk shells, the reception countertop overhang must always be centered or off-centered towards the inside of the reception desk shell unit.

Example 1: Standard desk shell with reception stack-on and partial depth FF pedestal.

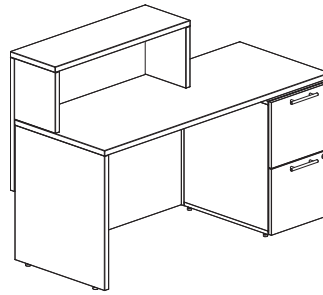
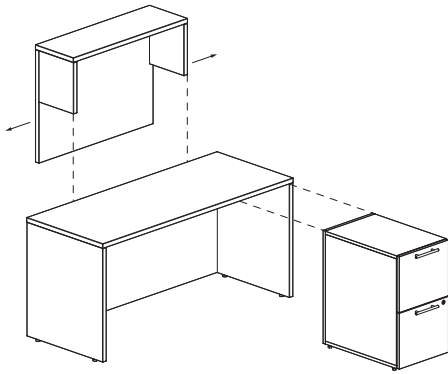

View behind reception desk

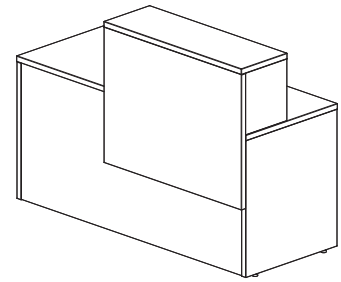

View from front of reception desk

Example 2: Reception desk shell with right reception return, reception worksurface and full depth FF pedestal.

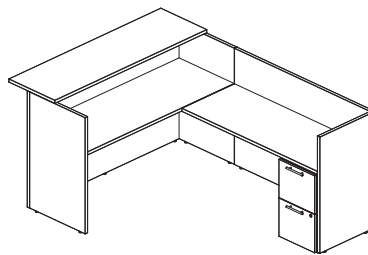
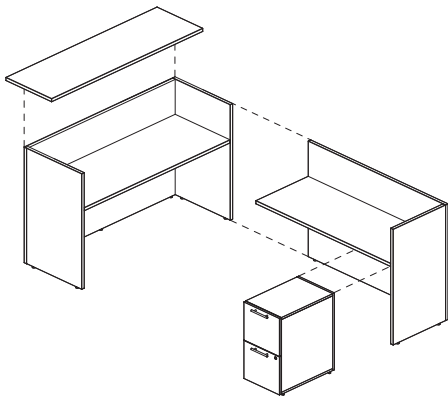

View behind reception desk

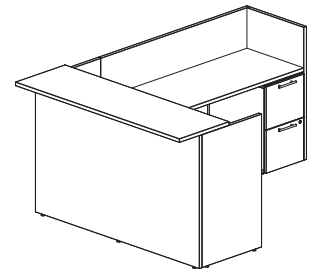

View from front of reception desk

Calibrate Product Details

Wall Mounted L Shelf Product Details

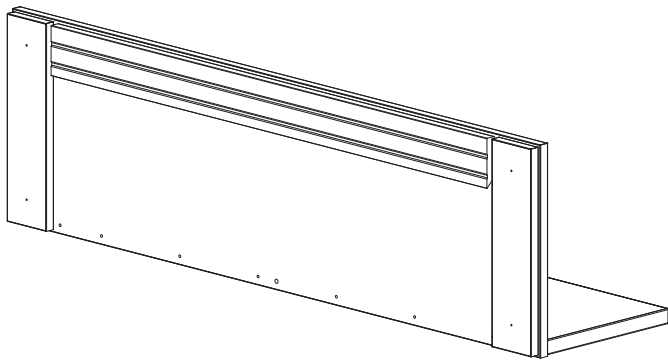

Backside of L Shelf

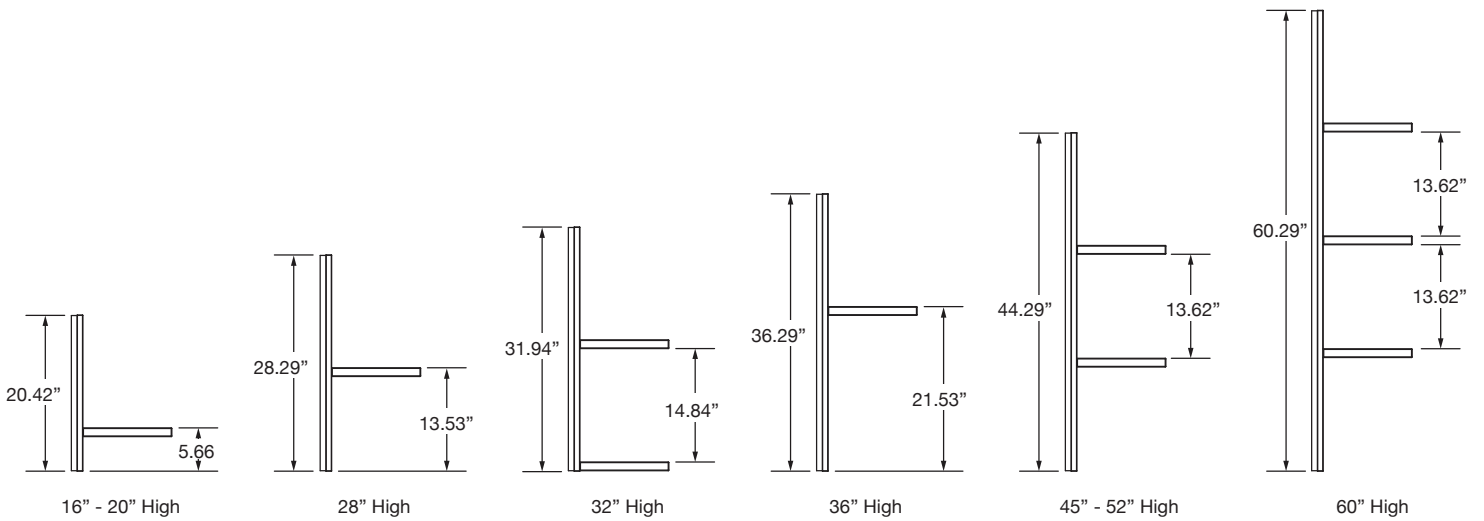
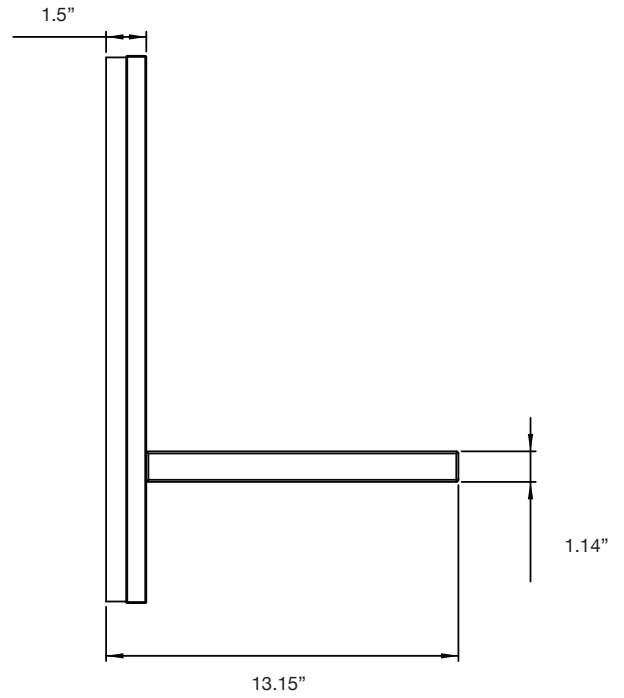

Wall Panel Product Details

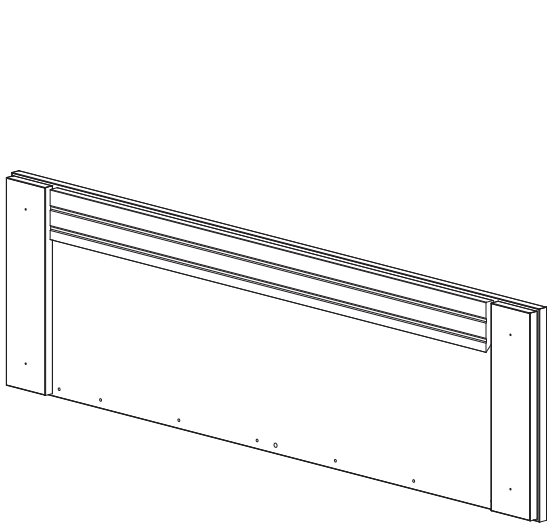

Backside of L Shelf

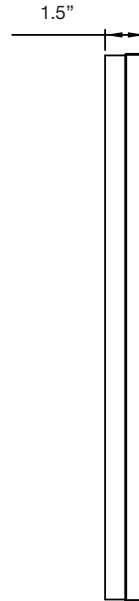

16" - 20" High



28" High

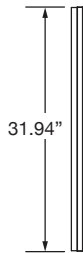

32" High



36" High



45" - 52" High



60" High

Typicals 1 & 2

Typical 1

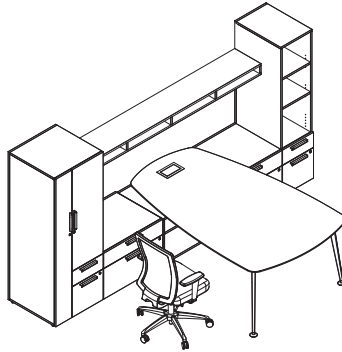

Description	Model Number	Quantity
1. CBX Floor Bookcase for Floating Tops 24Dx21Hx30W	X-BCRO2430	1x
2. CBX Wedge Floating Knife Edge Tprd Leg PWR 28-42Dx78W	X-FK-ROW2878TP	1x
3. CB Overhead WM Open 14Dx08Hx90W	C-OWM089014	1x
4. CBX Full Depth Lat BF 24Dx21Hx30W	X-PLAT2D3024	2x
5. CBX BF Ped Tower with Open Front 24Dx66Hx16W	X-PTBFOF66	1x
6. CBX Tackboard Wall Mount 20Hx90W	X-TACKWM2090	1x
7. CBX Wardrobe BF CD LH 24Dx66Hx24W	X-WBFCDL66	1x

Typical 2

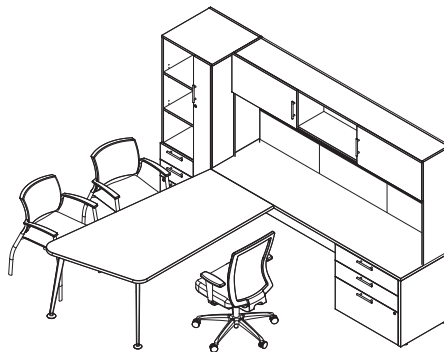

Description	Model Number	Quantity
1. CBX Partial Depth Lat BBF 22Dx28Hx36W	X-BBFLAT3623	1x
2. CB Desk Return RH 24Dx90Wx29H	X-DR9024R	1x
3. CBX Blade Run-Off Right Handed for Desk Shells w/Tapered Legs	X-DROBL3072T	1x
4. CBX Single Hutch with Sliding Doors 14Dx45Hx90W	X-SHSD4590	1x
5. CBX Tackboard Hutch Mount 28Hx90W	X-TACKHM2890	1x
6. CBX Open Front BBF Wardrobe RH 24Dx74Hx24W	X-WRBBFOF74	1x

Typical 3

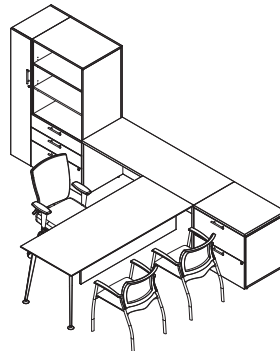

Description	Model Number	Quantity
1. Rectangular - 2mm Edge - 24D x 36W*	W-WS2436	1x
2. CBX BBF Lat Bookcase 24Dx66Hx30W	X-BBFLBC663024	1x
3. CB Desk Shell with Full Mod Flush 24Dx66Wx29h	X-DSFM6624	1x
4. CBX Rect Run-Off for Desk Shells 30Dx72W	X-DROR3072T	1x
5. CBX 2D Full Depth Lat 24Dx28Hx36W	X-LAT2DFS3624	1x
6. CBX Single Door Tower Hinge Left 24Dx66Hx12W	X-SDCL6624	1x
7. CBX Suspended HAT Modesty 12h for 72W (54 Actual)	X-HATM1272	1x

*Worksurfaces shown are not included in this price list. See AIS Worksurfaces and Support Price Lists to specify.

Typical 4

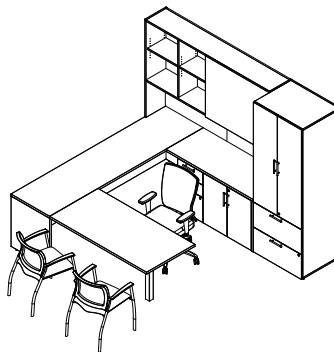

Description	Model Number	Quantity
1. CB Desk Return RH 24Dx54Wx29H	X-DR5424R	1x
2. CBX Partial Depth BBF Ped 22Dx28Hx16W	X-BBFFFS23	1x
3. CBX Partial Depth 2D Cab 22Dx28Hx30W	X-DDC3023	1x
4. CBX Double Hutch with Sliding Door RH 14Dx53Hx78W	X-DHSDR5378	1x
5. CB Desk Shell with Full Mod Flush 24Dx96Wx29h	X-DSFM9624	1x
6. CBX FF Lat with Cabinet Doors 24Dx82Hx30W	X-FFLCD823024	1x
7. CBX Tackboard Hutch Mount 20Hx78W	X-TACKHM2078	1x
8. CBX Rectangular RO for 29H Post Leg 30Dx60W	X-WSROR3060P	1x

Typicals 5 & 6

Typical 5

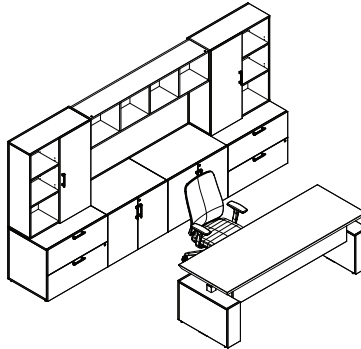

Description	Model Number	Quantity
1. Overhead - WM - 16H X 72W X 14D Open	C-OWM167214	1x
2. CBX Full Depth 2D Cab 24Dx28Hx36W	X-DDC3624	2x
3. CBX Height Adj Desk Knife Edge 30Dx84W	X-HAT2K3084	1x
4. CBX Suspended HAT Modesty 12h for 84W (66 Actual)	X-HATM1284	1x
5. CBX 2D Full Depth Lat 24Dx28Hx36W	X-LAT2DFS3624	2x
6. CBX Stack On Bookcase with Sliding Door LH 14Dx45Hx36W	X-SOSDL4536	1x
7. CBX Stack On Bookcase with Sliding Door RH 14Dx45Hx36W	X-SOSDR4536	1x
8. CBX Tackboard Wall Mount 28Hx72W	X-TACKWM2872	1x

Typical 6

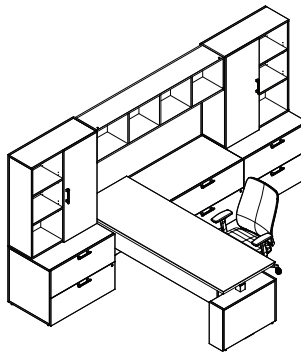

Description	Model Number	Quantity
1. Overhead - WM - 16H X 72W X 14D Open	C-OWM167214	1x
2. CBX Height Adj Desk Knife Edge with Fixed Mod 30Dx84W	X-HAT2KF3084	1x
3. CBX 2D Full Depth Lat 24Dx28Hx36W	X-LAT2DFS3624	2x
4. CBX 2D Full Depth Lat 24Dx28Hx42W	X-LAT2DFS4224	1x
5. CBX Stack On Bookcase with Sliding Door LH 14Dx45Hx36W	X-SOSDL4536	1x
6. CBX Stack On Bookcase with Sliding Door RH 14Dx45Hx36W	X-SOSDR4536	1x
7. CBX Tackboard Wall Mount 28Hx72W	X-TACKWM2872	1x

Typical 7

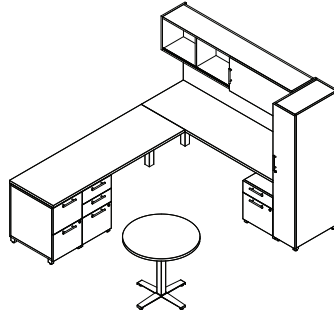

Description	Model Number	Quantity
1. CBU - Box / Box / File Pedestal	C-BBFPFS24	1x
2. CBU - Box / File Pedestal Mobile 18" deep	C-BFP18M	1x
3. CBU - File / File Pedestal	C-FFPFS24	1x
4. CBU - Overhead - WM - 16H X 72W X 14D - Sliding Laminate - RH	C-OWMS167214RL	1x
5. CB U-Channel - 60W	WPS-VC60	1x
6. CBU - 1 Door Cabinet - 66H X 12W X 24D - Laminate Door - Hinge Right	C-SDC661224LL	1x
7. CB Rectangular - 2mm Edge - 24D x 72W*	W-WS2472	2x
8. N-Leg 2.5 x 2.5 Single Crossbar 27" x 24" Freestanding*	WFS-NL22724	1x
9. TBL - Rnd, 2mm, 30Dx29H, STLX30, GLD	T-RDR3029SXG	1x
10. CBX Tackboard Wall Mount 20Hx72W	X-TACKWM2072	1x
11. CB Flat Plate	WPS-FP	2x
12. CB DESKING L-BRACKET BLACK	O-WSLB	1x

*Worksurfaces shown are not included in this price list. See AIS Worksurfaces and Support Price Lists to specify.

Typical 8

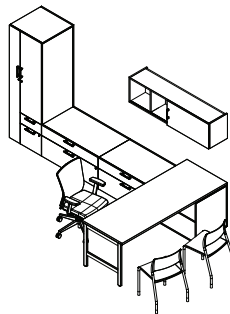

Description	Model Number	Quantity
1. Overhead - WM - 16H X 60W X 14D - Sliding Laminate - RH	C-OWMS166014RL	1x
2. Rectangular - 2mm Edge - 30D x 78W*	W-WS3078	1x
3. A-Leg - 1x2 Post - 27H - 30 Depth - Freestanding*	WFS-ALW2730FS	1x
4. CBX Full Depth Floor Bookcase 18Dx28Hx30W	X-CBC283018	1x
5. CBX Full Depth Lat BF 24Dx21Hx42W	X-PLAT2D4224	2x
6. CBX Wardrobe BF CD LH 24Dx74Hx24W	X-WBFCDL74	1x
7. U-Channel - 48W	WPS-VC48	2x

*Worksurfaces shown are not included in this price list. See AIS Worksurfaces and Support Price Lists to specify.

Typicals 9 & 10

Typical 9

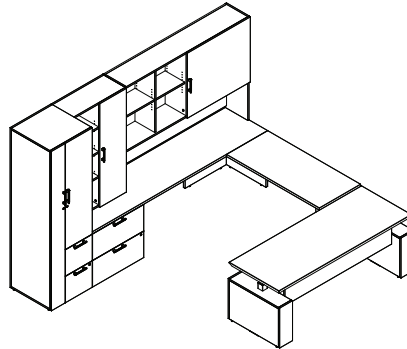

Description	Model Number	Quantity
1. CBX Wardrobe FF CD LH 24Dx82Hx24W	X-WFFCDL82	1x
2. CBX Tackboard Hutch Mount 20Hx66W	X-TACKHM2066	1x
3. CBX Stack On Bookcase with Sliding Door RH 14Dx53Hx30W	X-SOSDR5330	1x
4. CBX 2D Full Depth Lat 24Dx28Hx30W	X-LAT2DFS3024	1x
5. CBX Height Adj Desk Square Edge 30Dx78W	X-HATS3078	1x
6. CBX Suspended HAT Modesty 12h for 84W (66 Actual)	X-HATM1284	1x
7. CBX Double Hutch with Sliding Door RH 14Dx53Hx66W	X-DHSDR5366	1x
8. Flatplate	WPS-FP	2x
9. FLSP A - Male 1 End Flush - 24D*	WFS-FLSPMEF24	2x
10. FLSP F - Female 1 End - 24D*	WFS-FLSPF1E24	1x
11. FLSP F - Female 1 End - 12D*	WFS-FLSPF1E12	1x
12. Rectangular - 2mm Edge - 24D x 54W*	W-WS2454	1x
13. Rectangular - 2mm Edge - 24D x 96W*	W-WS2496	1x

*Worksurfaces shown are not included in this price list. See AIS Worksurfaces and Support Price Lists to specify.

Typical 10

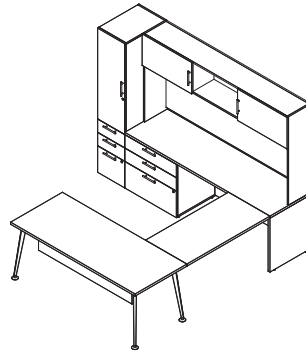

Description	Model Number	Quantity
1. Frameless Glass Modesty Kit 12"H X 54"W	A-FGMM1254	1x
2. TBL Rec Table Sq Cnr Tprd Leg 29Hx72Wx30D	T-RCR307229TPG	1x
3. CBX Partial Depth Lat BBF 22Dx28Hx30W	X-BBFLAT3023	1x
4. Rectangular - 2mm Edge - 24D x 48W*	W-WS2448	1x
5. CB Desk Return RH 24Dx84Wx29H	X-DR8424R	1x
6. CBX Ped Tower BBF with Cupboard Hinge Left 24Dx74Hx16W	X-PTBBFCL74	1x
7. CBX Single Hutch with Sliding Doors 14Dx45Hx84W	X-SHSD4584	1x
8. Flat Plate	WPS-FP	4x
9. CBX Tackboard Hutch Mount 28Hx84W	X-TACKHM2884	1x
10. CB U-Channel - 72W	WPS-VC72	1x

*Worksurfaces shown are not included in this price list. See AIS Worksurfaces and Support Price Lists to specify.

Typical 11

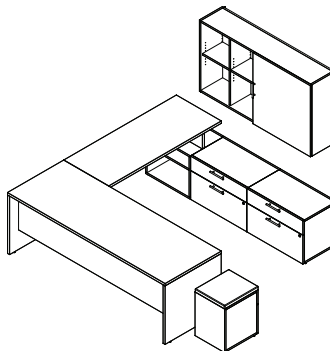

Description	Model Number	Quantity
1. 24" End Panel Riser*	X-RISER0724	1x
2. Rectangular - 2mm Edge - 24D x 60W*	W-WS2460	1x
3. CBX Full Depth Floor Bookcase 18Dx21Hx24W	X-CBC2024	1x
4. CB Desk Shell 3/4 Mod Recessed 30Dx84Wx29h	X-DS8430-3QM	1x
5. CBX Full Depth Lat BF 18Dx21Hx30W	X-PLAT2D3018	2x
6. CB Wall Mounted Cabinet Sliding Door RH 14Dx32Hx60W	X-SDRWM326014	1x
7. Box / File Pedestal Mobile 18" Deep	C-BFP18M	1x
8. Cushion for Pedestal Top Laminate Case Good 16.563 x 24.063	C-PEDCUSHION	1x
9. Flat Plate	WPS-FP	2x
10. CB U-Channel - 48W	WPS-VC48	1x

*Worksurfaces shown are not included in this price list. See AIS Worksurfaces and Support Price Lists to specify.

Typicals 12 & 13

Typical 12

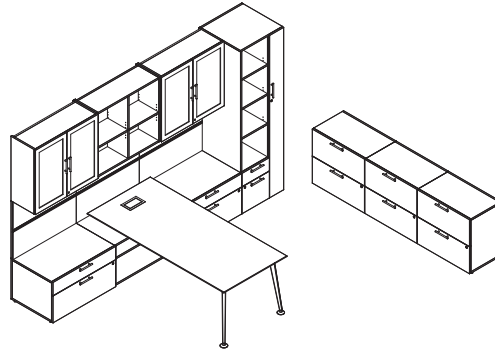

Description	Model Number	Quantity
1. CBX Floor Bookcase 24Dx21Hx36W	X-BCRO2436	1x
2. CBX Rect Knife Edge Floating Tprd Leg PWR 36Dx78W	X-FK-ROR3678TP	1x
3. CBX 2D Full Depth Lat 18Dx28Hx30W	X-LAT2DFS3018	3x
4. CBX Full Depth Lat BF 24Dx21Hx36W	X-PLAT2D3624	2x
5. CBX Open Front BF Wardrobe RH 24Dx82Hx24W	X-WRBF0F82	1x
6. CB Wall Mounted Bookcase Double Height 14Dx32Hx36W	X-ODWM323614	1x
7. CBX Tackboard Wall Mount with Tool Rail 28Hx36W	X-TACKWMT1436	3x
8. CB Wall Mounted With Framed Cabinet Doors- Double Height 14Dx32Hx36	X-GCDWM323614	2x

Typical 13

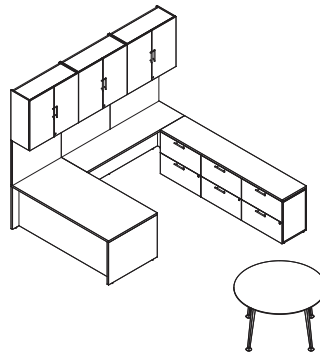

Description	Model Number	Quantity
1. TBL Round Table Tprd Leg 29Hx48Wx48D	T-RDR4829TPG	1x
2. CB Desk Return RH 20Dx72Wx29H	X-DR7220R	1x
3. CB Desk Shell Full Mod Recessed 36Dx72Wx29h	X-DS7236	1x
4. CBX 2D Full Depth Lat 18Dx28Hx30W	X-LAT2DFS3018	3x
5. CBX Tackboard Wall Mount 20Hx36W	X-TACKWM2036	3x
6. CB Wall Mounted Cabinet Double Height 14Dx32Hx36W	X-CDWM323614	3x

Typical 14

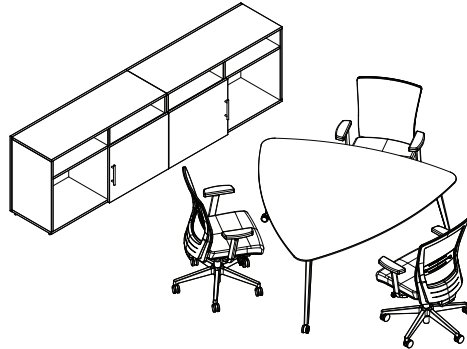

Description	Model Number	Quantity
1. TBL Knife Edge Triangle Table Tprd Leg Casters 29Hx60Wx36D	T-TRK6029TPC	1x
2. CBX Full Depth Cred with Sliding Doors LH 18Dx28Hx48W	X-CSDL2748	1x
3. CBX Full Depth Cred with Sliding Door RH 18Dx28Hx48W	X-CSDR2748	1x

Typical 15

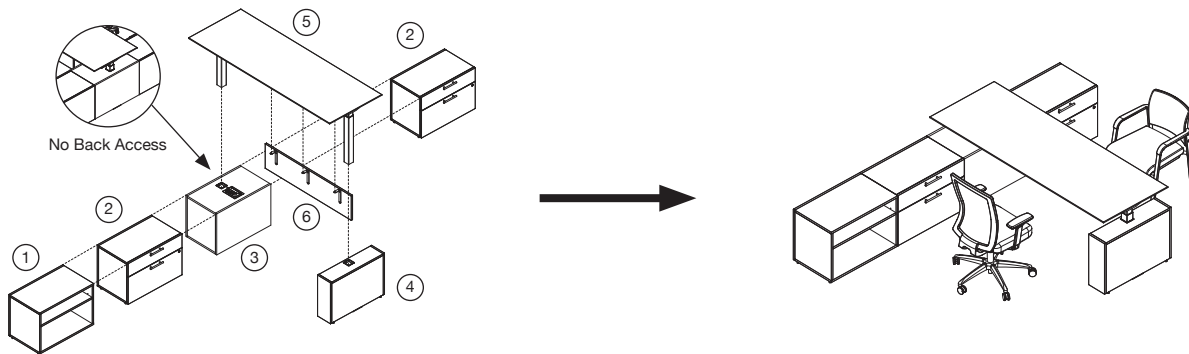

Description	Model Number	Quantity
1. CBX Full Depth Floor Bookcase 18Dx21Hx30W	X-CBC2030	1x
2. CBX Full Depth Lat BF 18Dx21Hx30W	X-PLAT2D3018	2x
3. CBX HAT BASE Powered-No Back Access 21Hx30Wx18D	X-HBPE3018	1x
4. CBX HAT BASE 30"	X-HBE30	1x
5. CBX HA 2-leg base with WS KNF Edge 30Dx84W	X-2HKE3084	1x
6. CBX Suspended HAT Modesty 12h for 66W (50 Actual)	X-HATM1266	x1

Typicals 16 & 17

Typical 16

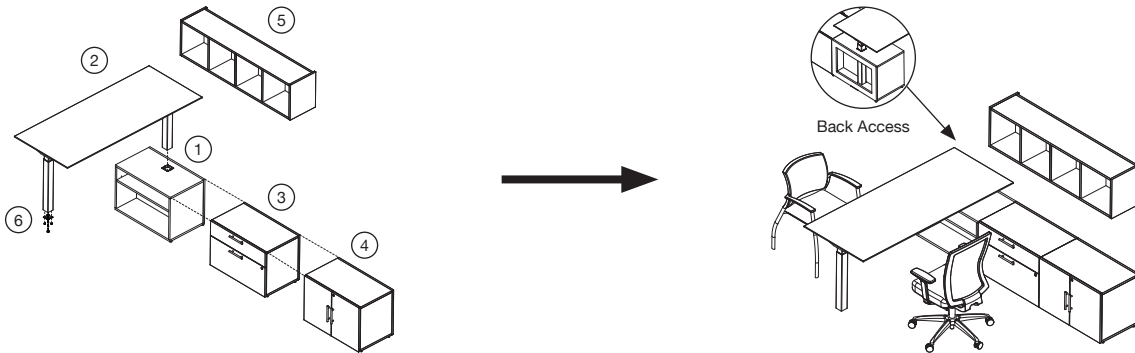

Description	Model Number	Quantity
1. CBX HAT Base Bookcase With Back Access 21H x30Wx18D	X-HBBCE-BA3018	x1
2. CBX HA 2-leg base with WS KNF Edge 30Dx72W	X-2HKE3072	x1
3. CBX Full Depth Lat BF 18Dx21Hx30W	X-PLAT2D3018	x1
4. CBX 2D Full Depth Cab 18Dx21Hx30W	X-CCD2030	x1
5. Overhead Wallmounted 16Hx60Wx4D Open	C-OWM166014	x1
6. Height Adjustable Table Foot Glide	O-GSO	x1

Typical 17

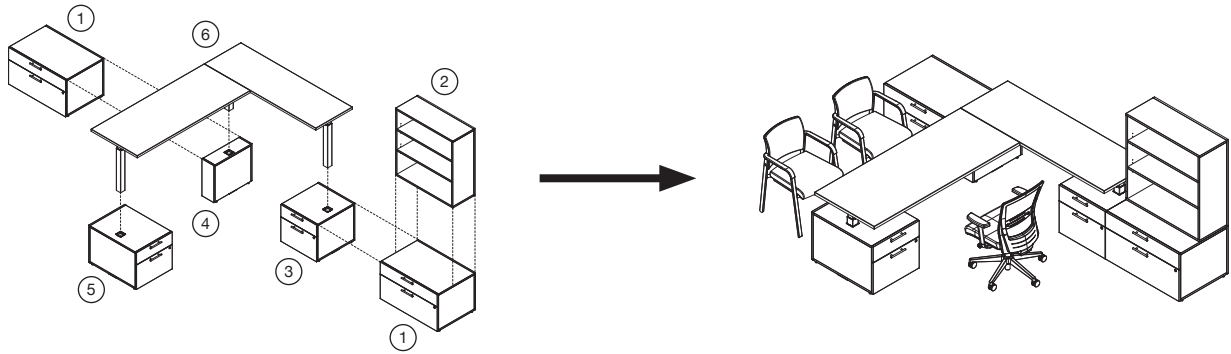

Description	Model Number	Quantity
1. CBX Full Depth Lat BF 24Dx21Hx36W	X-PLAT2D3624	x2
2. CBX Stack On Bookcase 14Dx37Hx36W	X-SOBC3736	x1
3. CBX BF HAT Base 24" Right	X-HBE24R	x1
4. CBX HAT Base 24"	X-HBE24	x1
5. CBX BF HAT Base 30" Left	X-HBE30L	x1
6. CBX HA 3-leg base WS SQ Edge 24Dx72Wx30Dx72W Main Left	X-3HSEL24723072	x1

24", 30" and 36" Deep Desk Shells

24" DESK SHELL								
			Full Modesty		Three-Quarter Modesty		Half Modesty	
H	W	D	Model Number	List	Model Number	List	Model Number	List
29	36	24	X-DS3624	1,127	X-DS3624-3QM	1,090	X-DS3624-HM	1,056
29	42	24	X-DS4224	1,169	X-DS4224-3QM	1,127	X-DS4224-HM	1,087
29	48	24	X-DS4824	1,217	X-DS4824-3QM	1,168	X-DS4824-HM	1,123
29	54	24	X-DS5424	1,262	X-DS5424-3QM	1,210	X-DS5424-HM	1,141
29	60	24	X-DS6024	1,313	X-DS6024-3QM	1,251	X-DS6024-HM	1,192
29	66	24	X-DS6624	1,360	X-DS6624-3QM	1,293	X-DS6624-HM	1,232
29	72	24	X-DS7224	1,409	X-DS7224-3QM	1,334	X-DS7224-HM	1,266
29	78	24	X-DS7824	1,456	X-DS7824-3QM	1,379	X-DS7824-HM	1,301
29	84	24	X-DS8424	1,505	X-DS8424-3QM	1,421	X-DS8424-HM	1,338
29	90	24	X-DS9024	1,551	X-DS9024-3QM	1,462	X-DS9024-HM	1,374
29	96	24	X-DS9624	1,597	X-DS9624-3QM	1,505	X-DS9624-HM	1,410

30" DESK SHELL								
			Full Modesty		Three-Quarter Modesty		Half Modesty	
H	W	D	Model Number	List	Model Number	List	Model Number	List
29	36	30	X-DS3630	1,210	X-DS3630-3QM	1,171	X-DS3630-HM	1,137
29	42	30	X-DS4230	1,257	X-DS4230-3QM	1,213	X-DS4230-HM	1,172
29	48	30	X-DS4830	1,312	X-DS4830-3QM	1,260	X-DS4830-HM	1,213
29	54	30	X-DS5430	1,362	X-DS5430-3QM	1,308	X-DS5430-HM	1,254
29	60	30	X-DS6030	1,342	X-DS6030-3QM	1,355	X-DS6030-HM	1,294
29	66	30	X-DS6630	1,471	X-DS6630-3QM	1,402	X-DS6630-HM	1,338
29	72	30	X-DS7230	1,522	X-DS7230-3QM	1,450	X-DS7230-HM	1,382
29	78	30	X-DS7830	1,575	X-DS7830-3QM	1,496	X-DS7830-HM	1,422
29	84	30	X-DS8430	1,643	X-DS8430-3QM	1,545	X-DS8430-HM	1,464
29	90	30	X-DS9030	1,682	X-DS9030-3QM	1,590	X-DS9030-HM	1,505
29	96	30	X-DS9630	1,734	X-DS9630-3QM	1,638	X-DS9630-HM	1,545

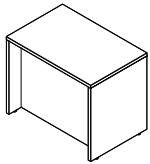

Full

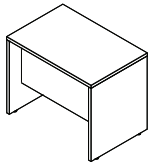

Three-Quarter

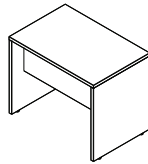

Half

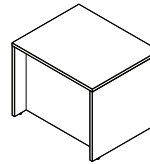

Full

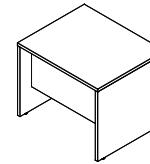

Three-Quarter

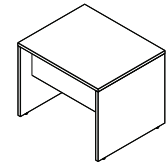

Half

36" DESK SHELL								
			Full Modesty		Three-Quarter Modesty		Half Modesty	
H	W	D	Model Number	List	Model Number	List	Model Number	List
29	36	36	X-DS3636	1,284	X-DS3636-3QM	1,254	X-DS3636-HM	1,220
29	42	36	X-DS4236	1,344	X-DS4236-3QM	1,267	X-DS4236-HM	1,224
29	48	36	X-DS4836	1,401	X-DS4836-3QM	1,354	X-DS4836-HM	1,308
29	54	36	X-DS5436	1,460	X-DS5436-3QM	1,406	X-DS5436-HM	1,354
29	60	36	X-DS6036	1,516	X-DS6036-3QM	1,458	X-DS6036-HM	1,399
29	66	36	X-DS6636	1,576	X-DS6636-3QM	1,512	X-DS6636-HM	1,448
29	72	36	X-DS7236	1,635	X-DS7236-3QM	1,563	X-DS7236-HM	1,494
29	78	36	X-DS7836	1,692	X-DS7836-3QM	1,614	X-DS7836-HM	1,542
29	84	36	X-DS8436	1,750	X-DS8436-3QM	1,668	X-DS8436-HM	1,587
29	90	36	X-DS9036	1,807	X-DS9036-3QM	1,721	X-DS9036-HM	1,633
29	96	36	X-DS9636	1,867	X-DS9636-3QM	1,773	X-DS9636-HM	1,681

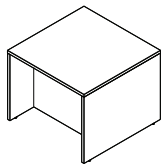

Full

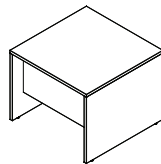

Three-Quarter

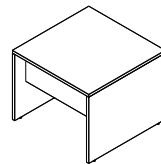

Half

Specify

Notes

- Laminate Selection for Worksurface
- Laminate Selection for Base
- Grommet Location

- Select sizes available on quick ship Calibrate Countdown program. See [Calibrate Countdown price list](#) for full details.

Desk Shells with Access Modesties

24" DEEP DESK SHELL FULL MODESTY WITH ACCESS MODESTY

H	W	D	Model Number	List
29	36	24	X-DSS3624	1,106
29	42	24	X-DSS4224	1,152
29	48	24	X-DSS4824	1,199
29	54	24	X-DSS5424	1,242
29	60	24	X-DSS6024	1,287
29	66	24	X-DSS6624	1,332
29	72	24	X-DSS7224	1,375
29	78	24	X-DSS7824	1,422
29	84	24	X-DSS8424	1,466
29	90	24	X-DSS9024	1,510
29	96	24	X-DSS9624	1,554

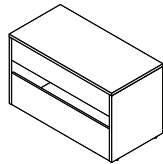

30" DEEP DESK SHELL FULL MODESTY WITH ACCESS MODESTY

H	W	D	Model Number	List
29	36	30	X-DSS3630	1,188
29	42	30	X-DSS4230	1,242
29	48	30	X-DSS4830	1,291
29	54	30	X-DSS5430	1,341
29	60	30	X-DSS6030	1,390
29	66	30	X-DSS6630	1,441
29	72	30	X-DSS7230	1,491
29	78	30	X-DSS7830	1,542
29	84	30	X-DSS8430	1,589
29	90	30	X-DSS9030	1,640
29	96	30	X-DSS9630	1,687

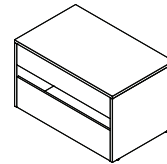

36" DEEP DESK SHELL FULL MODESTY WITH ACCESS MODESTY

H	W	D	Model Number	List
29	36	36	X-DSS3636	1,274
29	42	36	X-DSS4236	1,304
29	48	36	X-DSS4836	1,384
29	54	36	X-DSS5436	1,439
29	60	36	X-DSS6036	1,494
29	66	36	X-DSS6636	1,550
29	72	36	X-DSS7236	1,605
29	78	36	X-DSS7836	1,659
29	84	36	X-DSS8436	1,713
29	90	36	X-DSS9036	1,767
29	96	36	X-DSS9636	1,821

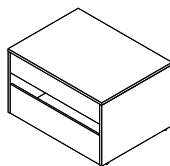

Specify

- Laminate Selection for Worksurface
- Laminate Selection for Base
- Grommet Location

Notes

- Modesty access has a 5" opening.
- Bottom modesty measures approximately 13" from floor to access opening.

Desk Shells with Full Modesty Flushes and Desk Shell Center Supports

24" DEEP DESK SHELL WITH FULL MODESTY FLUSH

H	W	D	Model Number	List
29	36	24	X-DSFM3624	1,128
29	42	24	X-DSFM4224	1,176
29	48	24	X-DSFM4824	1,218
29	54	24	X-DSFM5424	1,263
29	60	24	X-DSFM6024	1,314
29	66	24	X-DSFM6624	1,361
29	72	24	X-DSFM7224	1,410
29	78	24	X-DSFM7824	1,456
29	84	24	X-DSFM8424	1,506
29	90	24	X-DSFM9024	1,552
29	96	24	X-DSFM9624	1,601

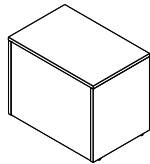

30" DEEP DESK SHELL WITH FULL MODESTY FLUSH

H	W	D	Model Number	List
29	36	30	X-DSFM3630	1,211
29	42	30	X-DSFM4230	1,263
29	48	30	X-DSFM4830	1,312
29	54	30	X-DSFM5430	1,362
29	60	30	X-DSFM6030	1,415
29	66	30	X-DSFM6630	1,471
29	72	30	X-DSFM7230	1,522
29	78	30	X-DSFM7830	1,576
29	84	30	X-DSFM8430	1,627
29	90	30	X-DSFM9030	1,682
29	96	30	X-DSFM9630	1,735

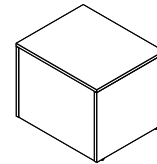

Specify

Notes

- Laminate Selection Worksurface
 - Laminate Selection for Base
 - Grommet Location
- Select sizes available on quick ship Calibrate Countdown program. See [Calibrate Countdown price list](#) for full details.

CALIBRATE DESK SHELL CENTER SUPPORT

H	W	Model Number	List
27	12	X-DSCS	441



Specify

Notes

- Laminate Selection
- Calibrate Desk Shell Center Support attaches with brackets into any position across the width of any desk shell.

Desk Returns

DESK RETURNS					
H	W	D	Left	Right	List
			Model Number	Model Number	
29	30	20	X-DR3020L	X-DR3020R	898
29	36	20	X-DR3620L	X-DR3620R	941
29	42	20	X-DR4220L	X-DR4220R	987
29	48	20	X-DR4820L	X-DR4820R	1,029
29	54	20	X-DR5420L	X-DR5420R	1,072
29	60	20	X-DR6020L	X-DR6020R	1,119
29	66	20	X-DR6620L	X-DR6620R	1,124
29	72	20	X-DR7220L	X-DR7220R	1,168
29	78	20	X-DR7820L	X-DR7820R	1,211
29	84	20	X-DR8420L	X-DR8420R	1,254
29	90	20	X-DR9020L	X-DR9020R	1,299
29	96	20	X-DR9620L	X-DR9620R	1,344
29	30	24	X-DR3024L	X-DR3024R	931
29	36	24	X-DR3624L	X-DR3624R	979
29	42	24	X-DR4224L	X-DR4224R	1,028
29	48	24	X-DR4824L	X-DR4824R	1,073
29	54	24	X-DR5424L	X-DR5424R	1,124
29	60	24	X-DR6024L	X-DR6024R	1,171
29	66	24	X-DR6624L	X-DR6624R	1,179
29	72	24	X-DR7224L	X-DR7224R	1,224
29	78	24	X-DR7824L	X-DR7824R	1,275
29	84	24	X-DR8424L	X-DR8424R	1,321
29	90	24	X-DR9024L	X-DR9024R	1,368
29	96	24	X-DR9624L	X-DR9624R	1,415

DESK RETURNS WITH ACCESS MODESTY					
H	W	D	Left	Right	List
			Model Number	Model Number	
29	30	20	X-DRR3020L	X-DRR3020R	945
29	36	20	X-DRR3620L	X-DRR3620R	989
29	42	20	X-DRR4220L	X-DRR4220R	1,030
29	48	20	X-DRR4820L	X-DRR4820R	1,072
29	54	20	X-DRR5420L	X-DRR5420R	1,116
29	60	20	X-DRR6020L	X-DRR6020R	1,157
29	66	20	X-DRR6620L	X-DRR6620R	1,198
29	72	20	X-DRR7220L	X-DRR7220R	1,240
29	78	20	X-DRR7820L	X-DRR7820R	1,281
29	84	20	X-DRR8420L	X-DRR8420R	1,323
29	90	20	X-DRR9020L	X-DRR9020R	1,365
29	96	20	X-DRR9620L	X-DRR9620R	1,448
29	30	24	X-DRR3024L	X-DRR3024R	1,008
29	36	24	X-DRR3624L	X-DRR3624R	1,051
29	42	24	X-DRR4224L	X-DRR4224R	1,093
29	48	24	X-DRR4824L	X-DRR4824R	1,139
29	54	24	X-DRR5424L	X-DRR5424R	1,181
29	60	24	X-DRR6024L	X-DRR6024R	1,222
29	66	24	X-DRR6624L	X-DRR6624R	1,266
29	72	24	X-DRR7224L	X-DRR7224R	1,307
29	78	24	X-DRR7824L	X-DRR7824R	1,350
29	84	24	X-DRR8424L	X-DRR8424R	1,394
29	90	24	X-DRR9024L	X-DRR9024R	1,434
29	96	24	X-DRR9624L	X-DRR9624R	1,476

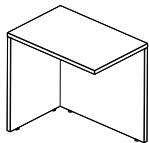

Left

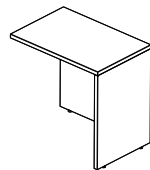

Right

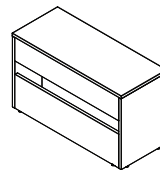

Left (Back)

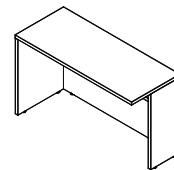

Left (Front)

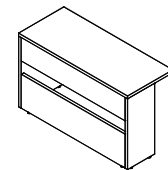

Right (Back)

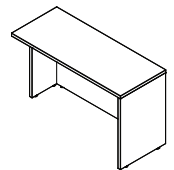

Right (Front)

Specify	Notes
• Laminate Selection for Worksurface	• Select sizes available on quick ship Calibrate Countdown program. See Calibrate Countdown price list for full details.
• Laminate Selection for Base	
• Grommet Location	

Specify	Notes
• Laminate Selection for Worksurface	• Modesty access has a 5" opening. • Bottom modesty measures approximately 13" from floor to access opening. • Support panel measures 12".
• Laminate Selection for Base	
• Grommet Location	

DESK BRIDGE WITH FULL MODESTY FLUSH

H	W	D	Model Number	List
29	30	20	X-DB3020	698
29	36	20	X-DB3620	727
29	42	20	X-DB4220	754
29	48	20	X-DB4820	780
29	54	20	X-DB5420	808
29	60	20	X-DB6020	840
29	30	24	X-DB3024	705
29	36	24	X-DB3624	736
29	42	24	X-DB4224	768
29	48	24	X-DB4824	801
29	54	24	X-DB5424	833
29	60	24	X-DB6024	866

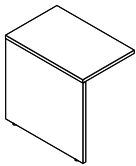

20" Deep

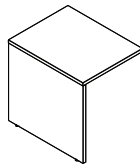

24" Deep

Specify

Notes

- Laminate Selection for Worksurface
- Laminate Selection for Base
- Grommet Location

- Select sizes available on quick ship Calibrate Countdown program. See [Calibrate Countdown price list](#) for full details.

Reception Desk Shells and Returns

RECEPTION DESK SHELL				
H	W	D	Model Number	List
42	60	24	X-RDSH2460	1,525
42	66	24	X-RDSH2466	1,590
42	72	24	X-RDSH2472	1,651
42	78	24	X-RDSH2478	1,712
42	84	24	X-RDSH2484	1,773
42	90	24	X-RDSH2490	1,833
42	96	24	X-RDSH2496	1,893
42	60	30	X-RDSH3060	1,657
42	66	30	X-RDSH3066	1,726
42	72	30	X-RDSH3072	1,797
42	78	30	X-RDSH3078	1,863
42	84	30	X-RDSH3084	1,932
42	90	30	X-RDSH3090	1,996
42	96	30	X-RDSH3096	2,065

RECEPTION RETURN					
H	W	D	Return Left	Return Right	List
			Model Number	Model Number	
42	36	20	X-RDRL2036	X-RDRR2036	977
42	42	20	X-RDRL2042	X-RDRR2042	1,028
42	48	20	X-RDRL2048	X-RDRR2048	1,075
42	54	20	X-RDRL2054	X-RDRR2054	1,127
42	60	20	X-RDRL2060	X-RDRR2060	1,178
42	36	24	X-RDRL2436	X-RDRR2436	1,020
42	42	24	X-RDRL2442	X-RDRR2442	1,073
42	48	24	X-RDRL2448	X-RDRR2448	1,128
42	54	24	X-RDRL2454	X-RDRR2454	1,181
42	60	24	X-RDRL2460	X-RDRR2460	1,222

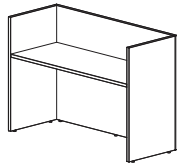

60 Wide

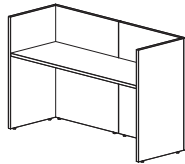

66 - 96 Wide

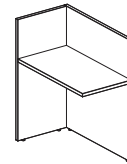

Return Left

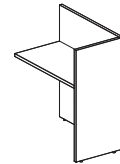

Return Right

Specify

- Laminate Selection for Worksurface
- Laminate Selection for Case
- Additional Grommet Locations (+45)
- Grommet Cover Color (if applicable)

Notes

- Ships knocked down.
- Laminate wood grain will run vertically for all panels 60" wide or less. Laminate wood grain will run horizontally for all panels greater than 60" wide.
- Grommet holes with covers are specified as options.

Reception Corner Stack-On

RECEPTION CORNER STACK-ON					
H	W	D	Left	Right	List
			Model Number	Model Number	
28	36	36	X-RDCSO3636L	X-RDCSO3636R	2,487
28	42	42	X-RDCSO4242L	X-RDCSO4242R	2,556
28	48	48	X-RDCSO4848L	X-RDCSO4848R	2,636
28	54	54	X-RDCSO5454L	X-RDCSO5454R	3,059
28	60	60	X-RDCSO6060L	X-RDCSO6060R	3,126
28	66	66	X-RDCSO6666L	X-RDCSO6666R	3,208
28	72	72	X-RDCSO7272L	X-RDCSO7272R	3,275
28	78	78	X-RDCSO7878L	X-RDCSO7878R	3,286
28	84	84	X-RDCSO8484L	X-RDCSO8484R	3,353
28	90	90	X-RDCSO9090L	X-RDCSO9090R	3,413
28	42	36	X-RDCSO4236L	X-RDCSO4236R	2,521
28	48	36	X-RDCSO4836L	X-RDCSO4836R	2,561
28	54	36	X-RDCSO5436L	X-RDCSO5436R	2,773
28	60	36	X-RDCSO6036L	X-RDCSO6036R	2,806
28	66	36	X-RDCSO6636L	X-RDCSO6636R	2,847
28	72	36	X-RDCSO7236L	X-RDCSO7236R	2,881
28	78	36	X-RDCSO7836L	X-RDCSO7836R	2,886
28	84	36	X-RDCSO8436L	X-RDCSO8436R	2,920
28	90	36	X-RDCSO9036L	X-RDCSO9036R	2,950
28	48	42	X-RDCSO4842L	X-RDCSO4842R	2,596
28	54	42	X-RDCSO5442L	X-RDCSO5442R	2,807
28	60	42	X-RDCSO6042L	X-RDCSO6042R	2,841
28	66	42	X-RDCSO6642L	X-RDCSO6642R	2,882
28	72	42	X-RDCSO7242L	X-RDCSO7242R	2,915
28	78	42	X-RDCSO7842L	X-RDCSO7842R	2,921
28	84	42	X-RDCSO8442L	X-RDCSO8442R	2,954
28	90	42	X-RDCSO9042L	X-RDCSO9042R	2,985
28	54	48	X-RDCSO5448L	X-RDCSO5448R	2,847

RECEPTION CORNER STACK-ON					
H	W	D	Left	Right	List
			Model Number	Model Number	
28	60	48	X-RDCSO6048L	X-RDCSO6048R	2,881
28	66	48	X-RDCSO6648L	X-RDCSO6648R	2,922
28	72	48	X-RDCSO7248L	X-RDCSO7248R	2,955
28	78	48	X-RDCSO7848L	X-RDCSO7848R	2,961
28	84	48	X-RDCSO8448L	X-RDCSO8448R	2,994
28	90	48	X-RDCSO9048L	X-RDCSO9048R	3,024
28	60	54	X-RDCSO6054L	X-RDCSO6054R	3,093
28	66	54	X-RDCSO6654L	X-RDCSO6654R	3,134
28	72	54	X-RDCSO7254L	X-RDCSO7254R	3,167
28	78	54	X-RDCSO7854L	X-RDCSO7854R	3,172
28	84	54	X-RDCSO8454L	X-RDCSO8454R	3,206
28	90	54	X-RDCSO9054L	X-RDCSO9054R	3,236
28	66	60	X-RDCSO6660L	X-RDCSO6660R	3,167
28	72	60	X-RDCSO7260L	X-RDCSO7260R	3,201
28	78	60	X-RDCSO7860L	X-RDCSO7860R	3,206
28	84	60	X-RDCSO8460L	X-RDCSO8460R	3,239
28	90	60	X-RDCSO9060L	X-RDCSO9060R	3,270
28	72	66	X-RDCSO7266L	X-RDCSO7266R	3,242
28	78	66	X-RDCSO7866L	X-RDCSO7866R	3,247
28	84	66	X-RDCSO8466L	X-RDCSO8466R	3,280
28	90	66	X-RDCSO9066L	X-RDCSO9066R	3,311
28	78	72	X-RDCSO7872L	X-RDCSO7872R	3,280
28	84	72	X-RDCSO8472L	X-RDCSO8472R	3,314
28	90	72	X-RDCSO9072L	X-RDCSO9072R	3,344
28	84	78	X-RDCSO8478L	X-RDCSO8478R	3,319
28	90	78	X-RDCSO9078L	X-RDCSO9078R	3,350
28	90	84	X-RDCSO9084L	X-RDCSO9084R	3,383

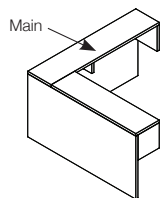

Return Left (symmetrical)

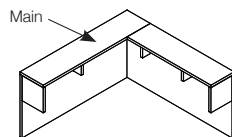

Return Right (symmetrical)

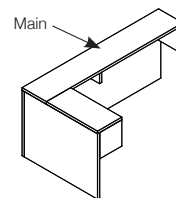

Return Left (asymmetrical)

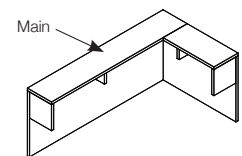

Return Right (asymmetrical)

Specify

- Laminate Selection for Worksurface
- Laminate Selection for Case

Notes

- Ships knocked down.
- Laminate wood grain will run vertically for all panels 60" wide or less.
- Laminate wood grain will run horizontally for all panels greater than 60" wide.

Reception Stack-Ons and Countertops

RECEPTION STACK-ON

H	W	D	Model Number	List
28	36	12	X-RDSO1236	1,244
28	42	12	X-RDSO1242	1,278
28	48	12	X-RDSO1248	1,318
28	54	12	X-RDSO1254	1,530
28	60	12	X-RDSO1260	1,563
28	66	12	X-RDSO1266	1,604
28	72	12	X-RDSO1272	1,638
28	78	12	X-RDSO1278	1,643
28	84	12	X-RDSO1284	1,677
28	90	12	X-RDSO1290	1,707
28	96	12	X-RDSO1296	1,740

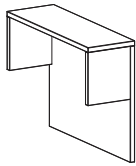

36 - 48 Wide

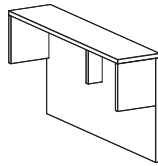

54 - 96 Wide

Specify

Notes

- Laminate Selection for Worksurface
- Laminate Selection for Case

- Ships knocked down.
- Laminate wood grain will run vertically for all panels 60" wide or less.
- Laminate wood grain will run horizontally for all panels greater than 60" wide.

RECEPTION COUNTERTOP

H	W	Model Number	List
12	24	X-RDCT1224	299
12	30	X-RDCT1230	344
12	33	X-RDCT1233	350
12	36	X-RDCT1236	367
12	39	X-RDCT1239	384
12	42	X-RDCT1242	431
12	45	X-RDCT1245	440
12	48	X-RDCT1248	458
12	54	X-RDCT1254	496
12	60	X-RDCT1260	536
12	66	X-RDCT1266	596
12	72	X-RDCT1272	642
12	78	X-RDCT1278	679
12	84	X-RDCT1284	755
12	90	X-RDCT1290	788
12	96	X-RDCT1296	859

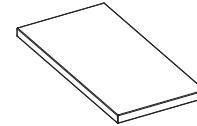

Specify

Notes

- Laminate Selection for Worksurface

- Includes brackets for mounting.
- Counter top width must always be smaller than or equal to width of reception desk shell.

Rectangular Floating Run-Off Worksurfaces

RECTANGULAR FLOATING RUN-OFFS (2MM EDGE WITH TAPERED LEG)					
		Powered		Non-Powered	
D	W	Model Number	List	Model Number	List
30	60	X-FS-ROR3060TP	4,859	X-FS-ROR3060T	1,893
30	66	X-FS-ROR3066TP	4,959	X-FS-ROR3066T	1,989
30	72	X-FS-ROR3072TP	5,003	X-FS-ROR3072T	2,033
30	78	X-FS-ROR3078TP	5,047	X-FS-ROR3078T	2,075
36	72	X-FS-ROR3672TP	5,043	X-FS-ROR3672T	2,154
36	78	X-FS-ROR3678TP	5,175	X-FS-ROR3678T	2,205

RECTANGULAR FLOATING RUN-OFFS (KNIFE EDGE WITH TAPERED LEG)					
		Powered		Non-Powered	
D	W	Model Number	List	Model Number	List
30	60	X-FK-ROR3060TP	6,204	X-FK-ROR3060T	3,357
30	66	X-FK-ROR3066TP	6,314	X-FK-ROR3066T	3,410
30	72	X-FK-ROR3072TP	6,374	X-FK-ROR3072T	3,467
30	78	X-FK-ROR3078TP	6,433	X-FK-ROR3078T	3,583
36	72	X-FK-ROR3672TP	6,539	X-FK-ROR3672T	3,690
36	78	X-FK-ROR3678TP	6,601	X-FK-ROR3678T	3,751

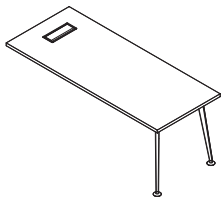

Powered

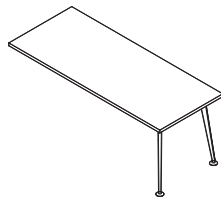

Non-Powered

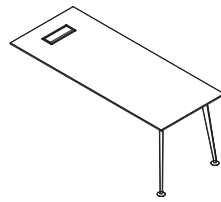

Powered

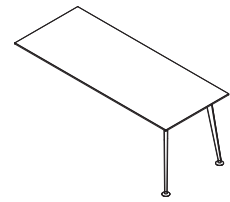

Non-Powered

Specify

- Laminate Selection for Worksurface
- Laminate Selection for Riser
- Edgeband Selection
- Finish Selection for Leg
- Paint Selection for Power - Black, Silver or White

Notes

- Power option includes access door with interior storage for devices with (3) standard 15 amp NEMA outlets, (2) 2.1 amp USBs, (2) 1 1/4 diamter pass through grommets and (2) Keystone style jack/device holes for data or HDMI jacks. Includes 15 amp overload switch with reset, surge protection.
- Includes attachment hardware and worksurface U-Channels.

Rectangular Floating Run-Off Worksurfaces

RECTANGULAR FLOATING RUN-OFFS (2MM EDGE WITH O-LEG)

D	W	Powered		Non-Powered	
		Model Number	List	Model Number	List
30	60	X-FS-ROR3060OP	5,588	X-FS-ROR3060O	2,177
30	66	X-FS-ROR3066OP	5,702	X-FS-ROR3066O	2,288
30	72	X-FS-ROR3072OP	5,754	X-FS-ROR3072O	2,338
30	78	X-FS-ROR3078OP	5,804	X-FS-ROR3078O	2,387
36	72	X-FS-ROR3672OP	5,799	X-FS-ROR3672O	2,477
36	78	X-FS-ROR3678OP	5,950	X-FS-ROR3678O	2,533

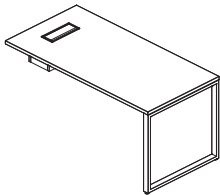

Powered

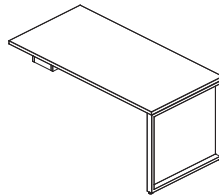

Non-Powered

Specify

- Laminate Selection for Worksurface
- Laminate Selection for Riser
- Edgeband Selection
- Paint Selection for Leg (+25 for Grade C)
- Paint Selection for Power - Black, Silver or White

Notes

- Power option includes access door with interior storage for devices with (3) standard 15 amp NEMA outlets, (2) 2.1 amp USBs, (2) 1 1/4 diameter pass through grommets and (2) Keystone style jack/device holes for data or HDMI jacks. Includes 15 amp overload switch with reset, surge protection.
- O-Legs are constructed from 1" x 2" painted steel.
- Legs have 1 1/2" leveling glides.
- Includes attachment hardware and worksurface U-Channels.

Radius Rectangular Floating Run-Off Worksurfaces

**RADIUS RECTANGULAR FLOATING RUN-OFFS
(2MM EDGE WITH TAPERED LEG)**

D	W	Powered		Non-Powered	
		Model Number	List	Model Number	List
30	60	X-FS-RORR3060TP	4,987	X-FS-RORR3060T	2,038
30	66	X-FS-RORR3066TP	5,087	X-FS-RORR3066T	2,139
30	72	X-FS-RORR3072TP	5,132	X-FS-RORR3072T	2,181
30	78	X-FS-RORR3078TP	5,174	X-FS-RORR3078T	2,226
36	72	X-FS-RORR3672TP	5,258	X-FS-RORR3672T	2,307
36	78	X-FS-RORR3678TP	5,303	X-FS-RORR3678T	2,358

**RADIUS RECTANGULAR FLOATING RUN-OFFS
(KNIFE EDGE WITH TAPERED LEG)**

D	W	Powered		Non-Powered	
		Model Number	List	Model Number	List
30	60	X-FK-RORR3060TP	6,203	X-FK-RORR3060T	3,356
30	66	X-FK-RORR3066TP	6,314	X-FK-RORR3066T	3,467
30	72	X-FK-RORR3072TP	6,374	X-FK-RORR3072T	3,525
30	78	X-FK-RORR3078TP	6,432	X-FK-RORR3078T	3,583
36	72	X-FK-RORR3672TP	6,537	X-FK-RORR3672T	3,690
36	78	X-FK-RORR3678TP	6,601	X-FK-RORR3678T	3,751

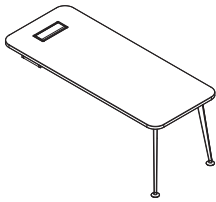

Powered

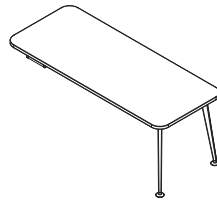

Non-Powered

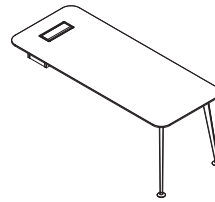

Powered

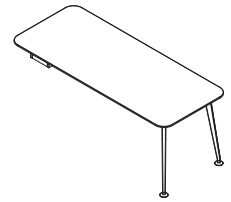

Non-Powered

Specify

- Laminate Selection for Worksurface
- Laminate Selection for Riser
- Edgeband Selection
- Finish Selection for Leg
- Paint Selection for Power - Black, Silver or White

Notes

- Power option includes access door with interior storage for devices with (3) standard 15 amp NEMA outlets, (2) 2.1 amp USBs, (2) 1 1/4 diamter pass through grommets and (2) Keystone style jack/device holes for data or HDMI jacks. Includes 15 amp overload switch with reset, surge protection.
- Includes attachment hardware and worksurface U-Channels.

Blade and Wedge Floating Run-Off Worksurfaces

BLADE FLOATING RUN-OFFS (2MM EDGE WITH TAPERED LEG)

D	W	Handing	Powered		Non-Powered	
			Model Number	List	Model Number	List
30	72	Left	X-FS-ROBL3072TP	5,312	X-FS-ROBL3072T	2,366
30	78	Left	X-FS-ROBL3078TP	5,366	X-FS-ROBL3078T	2,419
30	72	Right	X-FS-ROBR3072TP	5,312	X-FS-ROBR3072T	2,366
30	78	Right	X-FS-ROBR3078TP	5,366	X-FS-ROBR3078T	2,419

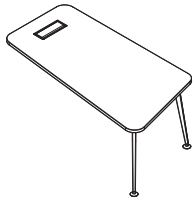

Powered

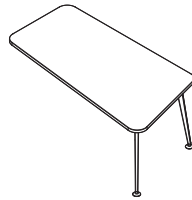

Non-Powered

BLADE FLOATING RUN-OFFS (KNIFE EDGE WITH TAPERED LEG)

D	W	Handing	Powered		Non-Powered	
			Model Number	List	Model Number	List
30	72	Left	X-FK-ROBL3072TP	6,600	X-FK-ROBL3072T	3,853
30	78	Left	X-FK-ROBL3078TP	6,669	X-FK-ROBL3078T	3,920
30	72	Right	X-FK-ROBR3072TP	6,600	X-FK-ROBR3072T	3,853
30	78	Right	X-FK-ROBR3078TP	6,669	X-FK-ROBR3078T	3,920

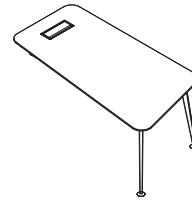

Powered

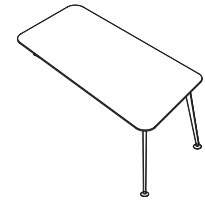

Non-Powered

WEDGE FLOATING RUN-OFFS (2MM EDGE WITH TAPERED LEG)

D	W	Powered		Non-Powered	
		Model Number	List	Model Number	List
28	66	X-FS-ROW2866TP	5,258	X-FS-ROW2866T	2,308
28	72	X-FS-ROW2872TP	5,433	X-FS-ROW2872T	2,570
28	78	X-FS-ROW2878TP	5,557	X-FS-ROW2878T	2,610
32	72	X-FS-ROW3272TP	5,386	X-FS-ROW3272T	2,376
32	78	X-FS-ROW3278TP	5,508	X-FS-ROW3278T	2,590

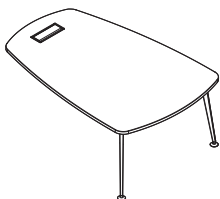

Powered

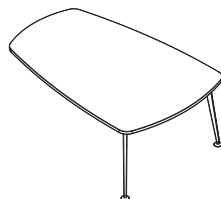

Non-Powered

WEDGE FLOATING RUN-OFFS (KNIFE EDGE WITH TAPERED LEG)

D	W	Powered		Non-Powered	
		Model Number	List	Model Number	List
28	66	X-FK-ROW2866TP	6,674	X-FK-ROW2866T	3,827
28	72	X-FK-ROW2872TP	6,907	X-FK-ROW2872T	4,060
28	78	X-FK-ROW2878TP	7,135	X-FK-ROW2878T	4,162
32	72	X-FK-ROW3272TP	6,917	X-FK-ROW3272T	4,070
32	78	X-FK-ROW3278TP	7,063	X-FK-ROW3278T	4,192

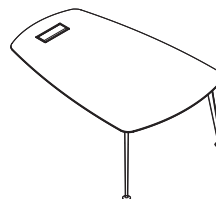

Powered

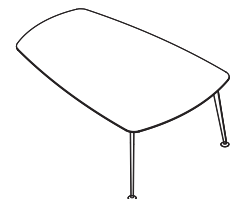

Non-Powered

Specify

- Laminate Selection for Worksurface
- Laminate Selection for Riser
- Edgeband Selection
- Finish Selection for Leg
- Paint Selection for Power - Black, Silver or White

Notes

- Power option includes access door with interior storage for devices with (3) standard 15 amp NEMA outlets, (2) 2.1 amp USBs, (2) 1 1/4 diameter pass through grommets and (2) Keystone style jack/device holes for data or HDMI jacks. Includes 15 amp overload switch with reset, surge protection.
- Includes attachment hardware and worksurface U-Channels.

Run-Offs for 29" High Post Legs

RECTANGULAR RUN-OFF FOR 29" HIGH POST LEGS

D	W	2mm Edge		Knife Edge	
		Model Number	List	Model Number	List
30	60	X-WSROR3060P	960	X-WSROK3060P	2,423
30	66	X-WSROR3066P	992	X-WSROK3066P	2,479
30	72	X-WSROR3072P	1,003	X-WSROK3072P	2,518
30	78	X-WSROR3078P	1,049	X-WSROK3078P	2,598
36	72	X-WSROR3672P	1,109	X-WSROK3672P	2,685
36	78	X-WSROR3678P	1,156	X-WSROK3678P	2,750

WEDGE RUN-OFF FOR 29" HIGH POST LEGS

D	W	2mm Edge		Knife Edge	
		Model Number	List	Model Number	List
42	66	X-WSROW4266P	1,313	X-WSROKW4266P	2,861
42	72	X-WSROW4272P	1,471	X-WSROKW4272P	3,081
42	78	X-WSROW4278P	1,544	X-WSROKW4278P	3,175
48	66	X-WSROW4866P	1,404	X-WSROKW4866P	2,991
48	72	X-WSROW4872P	1,573	X-WSROKW4872P	3,219
48	78	X-WSROW4878P	1,647	X-WSROKW4878P	3,318

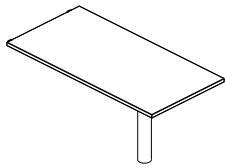

2mm Edge

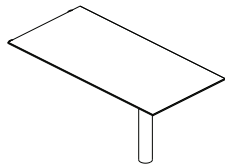

Knife Edge

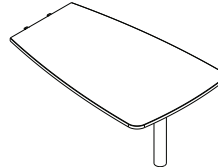

2mm Edge

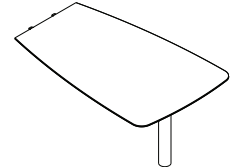

Knife Edge

BLADE RUN-OFF FOR 29" HIGH POST LEGS

D	W	Handing	2mm Edge		Knife Edge	
			Model Number	List	Model Number	List
30	60	Left	X-WSROBL3060P	1,186	X-WSROKBL3060P	2,703
30	66	Left	X-WSROBL3066P	1,240	X-WSROKBL3066P	2,773
30	72	Left	X-WSROBL3072P	1,293	X-WSROKBL3072P	2,847
30	78	Left	X-WSROBL3078P	1,352	X-WSROKBL3078P	2,918
30	60	Right	X-WSROBR3060P	1,186	X-WSROKBR3060P	2,703
30	66	Right	X-WSROBR3066P	1,240	X-WSROKBR3066P	2,773
30	72	Right	X-WSROBR3072P	1,293	X-WSROKBR3072P	2,847
30	78	Right	X-WSROBR3078P	1,352	X-WSROKBR3078P	2,918

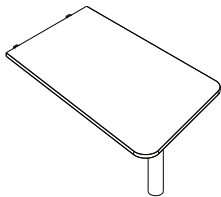

2mm Edge

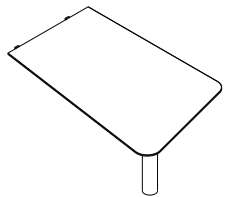

Knife Edge

Specify

- Laminate Selection for Worksurface
- Edgeband Selection
- Leg Selection - Round or Square
- Finish Selection for Leg

Notes

- Default Symbol is round leg, for square leg please select under options.
- For use without power needs.
- Includes attachment hardware.
- Left hand blade run-off shown above.

Run-Offs for Desk Shells

RECTANGULAR RUN-OFF FOR DESK SHELLS

D	W	2mm Edge with Tapered Leg		Knife Edge with Tapered Leg	
		Model Number	List	Model Number	List
30	60	X-DROR3060T	1,876	X-DROK3060T	3,353
30	66	X-DROR3066T	1,923	X-DROK3066T	3,409
30	72	X-DROR3072T	1,965	X-DROK3072T	3,447
30	78	X-DROR3078T	2,008	X-DROK3078T	3,527
36	72	X-DROR3672T	2,091	X-DROK3672T	3,633
36	78	X-DROR3678T	2,137	X-DROK3678T	3,696

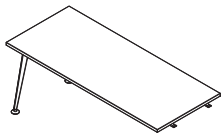

2mm Edge

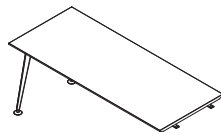

Knife Edge

WEDGE RUN-OFF FOR DESK SHELLS

D	W	2mm Edge with Tapered Leg		Knife Edge with Tapered Leg	
		Model Number	List	Model Number	List
42	66	X-DROW4266T	2,322	X-DROKW4266T	3,839
42	72	X-DROW4272T	2,480	X-DROKW4272T	4,057
42	78	X-DROW4278T	2,554	X-DROKW4278T	4,151
48	66	X-DROW4866T	2,446	X-DROKW4866T	3,996
48	72	X-DROW4872T	2,615	X-DROKW4872T	4,227
48	78	X-DROW4878T	2,691	X-DROKW4878T	4,325

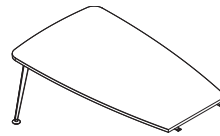

2mm Edge

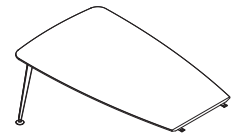

Knife Edge

BLADE RUN-OFF FOR DESK SHELLS

D	W	Handing	2mm Edge with Tapered Leg		Knife Edge with Tapered Leg	
			Model Number	List	Model Number	List
30	60	Left	X-DROBL3060T	2,182	X-DROKBL3060T	3,928
30	66	Left	X-DROBL3066T	2,238	X-DROKBL3066T	4,000
30	72	Left	X-DROBL3072T	2,291	X-DROKBL3072T	4,071
30	78	Left	X-DROBL3078T	2,343	X-DROKBL3078T	4,143
30	60	Right	X-DROBR3060T	2,182	X-DROKBR3060T	3,928
30	66	Right	X-DROBR3066T	2,238	X-DROKBR3066T	4,000
30	72	Right	X-DROBR3072T	2,291	X-DROKBR3072T	4,071
30	78	Right	X-DROBR3078T	2,343	X-DROKBR3078T	4,143

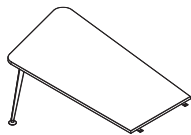

2mm Edge

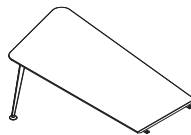

Knife Edge

Specify

- Laminate Selection for Worksurface
- Edgeband Selection
- Finish Selection for Leg

Notes

- For use without power needs.
- Includes attachment hardware.
- Left hand blade run-off shown above.

Rectangular Run-Offs

RECTANGULAR RUN-OFF WITH POST LEG					
		Without Modesty		With Modesty	
D	W	Model Number	List	Model Number	List
24	36	X-RRO2436P	1,082	X-RROM2436P	1,291
24	42	X-RRO2442P	1,096	X-RROM2442P	1,329
24	48	X-RRO2448P	1,130	X-RROM2448P	1,384
24	54	X-RRO2454P	1,164	X-RROM2454P	1,439
24	60	X-RRO2460P	1,198	X-RROM2460P	1,543
24	66	X-RRO2466P	1,230	X-RROM2466P	1,583
30	48	X-RRO3048P	1,193	X-RROM3048P	1,449
30	54	X-RRO3054P	1,236	X-RROM3054P	1,511
30	60	X-RRO3060P	1,278	X-RROM3060P	1,582
30	66	X-RRO3066P	1,319	X-RROM3066P	1,641
30	72	X-RRO3072P	1,360	X-RROM3072P	1,701
36	66	X-RRO3666P	1,440	X-RROM3666P	1,761
36	72	X-RRO3672P	1,495	X-RROM3672P	1,836

RECTANGULAR RUN-OFF WITH POST LEG					
		Without Modesty		With Modesty	
D	W	Model Number	List	Model Number	List
24	48	X-RROFS2448P	1,430	X-RROFSM2448P	1,521
24	54	X-RROFS2454P	1,464	X-RROFSM2454P	1,571
24	60	X-RROFS2460P	1,495	X-RROFSM2460P	1,616
24	66	X-RROFS2466P	1,525	X-RROFSM2466P	1,671
30	48	X-RROFS3048P	1,527	X-RROFSM3048P	1,619
30	54	X-RROFS3054P	1,569	X-RROFSM3054P	1,672
30	60	X-RROFS3060P	1,606	X-RROFSM3060P	1,726
30	66	X-RROFS3066P	1,645	X-RROFSM3066P	1,791
30	72	X-RROFS3072P	1,684	X-RROFSM3072P	1,844
36	66	X-RROFS3666P	1,762	X-RROFSM3666P	1,908
36	72	X-RROFS3672P	1,807	X-RROFSM3672P	1,969

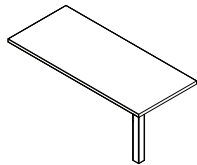

Without Modesty

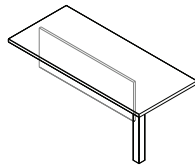

With Modesty

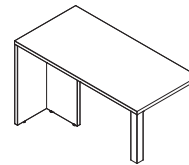

Without Modesty

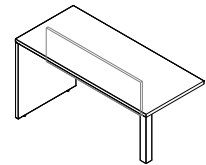

With Modesty

- | Specify | Notes |
|-----------------------------------------------------------------------------------------------------------------------------------------------------------------------------------------------------|---------------------------------------------------------------------------------------------------------------------------------------------------------------------------------------------------------------|
| <ul style="list-style-type: none"> • Laminate Selection for Worksurface • Edgeband Selection • Leg Selection - Round or Square • Finish Selection for Leg | <ul style="list-style-type: none"> • Default Symbol is round leg, for square leg please select under options. • Includes attachment hardware. • Cannot be used freestanding. |

- | Specify | Notes |
|--------------------------------------------------------------------------------------------------------------------------------------------------------------------------------------------------------------------------------------------|---------------------------------------------------------------------------------------------------------------------------------------------------------------------------------------------------------------|
| <ul style="list-style-type: none"> • Laminate Selection for Worksurface • Laminate Selection for Base • Edgeband Selection • Leg Selection - Round or Square • Finish Selection for Leg | <ul style="list-style-type: none"> • Default Symbol is round leg, for square leg please select under options. • Includes attachment hardware. • Cannot be used freestanding. |

Rectangular Run-Offs

2MM EDGE RECTANGULAR RUN-OFFS WITH O-LEGS

D	W	Model Number	List
24	36	X-DROR2436O	1,879
24	42	X-DROR2442O	1,932
24	48	X-DROR2448O	1,982
24	54	X-DROR2454O	2,033
24	60	X-DROR2460O	2,083
24	66	X-DROR2466O	2,137
24	72	X-DROR2472O	2,185
24	78	X-DROR2478O	2,235
24	84	X-DROR2484O	2,285
30	36	X-DROR3036O	1,954
30	42	X-DROR3042O	2,005
30	48	X-DROR3048O	2,056
30	54	X-DROR3054O	2,108
30	60	X-DROR3060O	2,157
30	66	X-DROR3066O	2,211
30	72	X-DROR3072O	2,259
30	78	X-DROR3078O	2,308
30	84	X-DROR3084O	2,360
36	72	X-DROR3672O	2,402
36	78	X-DROR3678O	2,456

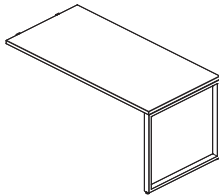

Specify

- Laminate Selection for Worksurface
- Edgeband Selection
- Paint Selection for Leg (+25 for Grade C)

Notes

- O-Legs are constructed from 1" x 2" painted steel.
- Legs have 1 1/2" leveling glides.
- Includes attachment hardware. Units 48" wide and over also include a worksurface u-channel.

D TOP					
D	W	Without Modesty		With Modesty	
		Model Number	List	Model Number	List
24	36	X-DTOP2436	1,093	X-DTOPM2436P	1,455
24	42	X-DTOP2442	1,110	X-DTOPM2442P	1,493
24	48	X-DTOP2448	1,146	X-DTOPM2448P	1,549
24	54	X-DTOP2454	1,182	X-DTOPM2454P	1,612
24	60	X-DTOP2460	1,219	X-DTOPM2460P	1,645
24	66	X-DTOP2466	1,254	X-DTOPM2466P	1,722
30	48	X-DTOP3048	1,213	X-DTOPM3048P	1,614
30	54	X-DTOP3054	1,260	X-DTOPM3054P	1,690
30	60	X-DTOP3060	1,309	X-DTOPM3060P	1,754
30	66	X-DTOP3066	1,358	X-DTOPM3066P	1,821
30	72	X-DTOP3072	1,389	X-DTOPM3072P	1,878
36	66	X-DTOP3666	1,435	X-DTOPM3666P	1,929
36	72	X-DTOP3672	1,483	X-DTOPM3672P	1,952

D TOP					
D	W	Without Modesty		With Modesty	
		Model Number	List	Model Number	List
24	36	X-DTOPFS2436P	1,584	X-DTOPFSM2436P	1,734
24	42	X-DTOPFS2442P	1,616	X-DTOPFSM2442P	1,782
24	48	X-DTOPFS2448P	1,653	X-DTOPFSM2448P	1,835
24	54	X-DTOPFS2454P	1,686	X-DTOPFSM2454P	1,880
24	60	X-DTOPFS2460P	1,718	X-DTOPFSM2460P	1,928
24	66	X-DTOPFS2466P	1,750	X-DTOPFSM2466P	1,976
30	48	X-DTOPFS3048P	1,784	X-DTOPFSM3048P	1,963
30	54	X-DTOPFS3054P	1,821	X-DTOPFSM3054P	2,019
30	60	X-DTOPFS3060P	1,862	X-DTOPFSM3060P	2,073
30	66	X-DTOPFS3066P	1,901	X-DTOPFSM3066P	2,128
30	72	X-DTOPFS3072P	1,942	X-DTOPFSM3072P	2,180
36	66	X-DTOPFS3666P	2,060	X-DTOPFSM3666P	2,287
36	72	X-DTOPFS3672P	2,105	X-DTOPFSM3672P	2,345

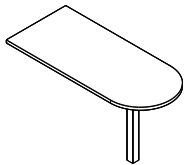

Without Modesty

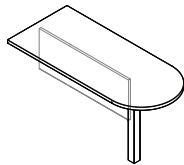

With Modesty

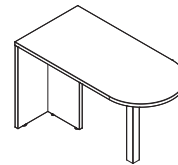

Without Modesty

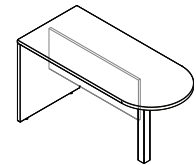

With Modesty

Specify	Notes
<ul style="list-style-type: none"> • Laminate Selection for Worksurface • Edgeband Selection • Leg Selection - Round or Square • Finish Selection for Leg 	<ul style="list-style-type: none"> • Default Symbol is round leg, for square leg please select under options. • Includes attachment hardware. • Cannot be used freestanding.

Specify	Notes
<ul style="list-style-type: none"> • Laminate Selection for Worksurface • Laminate Selection for Base • Edgeband Selection • Leg Selection - Round or Square • Finish Selection for Leg 	<ul style="list-style-type: none"> • Default Symbol is round leg, for square leg please select under options. • Includes attachment hardware. • Cannot be used freestanding.

Stack-On Desks

STACK-ON DESKS					
H	W	D	Left Hand	Right Hand	List
			Model Number	Model Number	
28	42	24	X-SODL284224	X-SODR284224	1,087
28	48	24	X-SODL284824	X-SODR284824	1,123
28	54	24	X-SODL285424	X-SODR285424	1,141
28	60	24	X-SODL286024	X-SODR286024	1,192
28	66	24	X-SODL286624	X-SODR286624	1,232
28	72	24	X-SODL287224	X-SODR287224	1,266
28	78	24	X-SODL287824	X-SODR287824	1,301
28	84	24	X-SODL288424	X-SODR288424	1,338
28	42	30	X-SODL284230	X-SODR284230	1,172
28	48	30	X-SODL284830	X-SODR284830	1,213
28	54	30	X-SODL285430	X-SODR285430	1,254
28	60	30	X-SODL286030	X-SODR286030	1,294
28	66	30	X-SODL286630	X-SODR286630	1,338
28	72	30	X-SODL287230	X-SODR287230	1,382
28	78	30	X-SODL287830	X-SODR287830	1,422
28	84	30	X-SODL288430	X-SODR288430	1,464

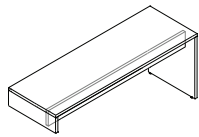

Left

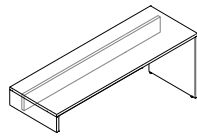

Right

Specify	Notes
<ul style="list-style-type: none"> • Laminate Selection for Worksurface • Laminate Selection for Case • Edgeband Selection 	<ul style="list-style-type: none"> • Features a laminate riser. • Stack on Desks are designed to be stacked on 21" high floor storage or 21" high Calibrate Community spine beams to serve as run-off desks perpendicular to spines.

CENTERED STACK-ON DESKS					
H	W	D	Model Number	List	
28	42	36	X-SODM284236	1,224	
28	48	36	X-SODM284836	1,308	
28	54	36	X-SODM285436	1,354	
28	60	36	X-SODM286036	1,399	
28	66	36	X-SODM286636	1,448	
28	72	36	X-SODM287236	1,494	
28	78	36	X-SODM287836	1,542	
28	84	36	X-SODM288436	1,587	

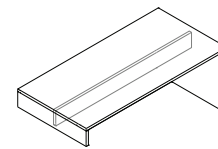

Specify	Notes
<ul style="list-style-type: none"> • Laminate Selection for Worksurface • Laminate Selection for Case • Edgeband Selection 	<ul style="list-style-type: none"> • Features a laminate riser. • Stack on Desks are designed to be stacked on 21" high floor storage or 21" high Calibrate Community spine beams to serve as run-off desks perpendicular to spines.

STACK-ON DESK WITH O-LEGS

H	W	D	Model Number	List
29	42	24	X-SODO284224	1,248
29	48	24	X-SODO284824	1,290
29	54	24	X-SODO285424	1,313
29	60	24	X-SODO286024	1,369
29	66	24	X-SODO286624	1,415
29	72	24	X-SODO287224	1,454
29	78	24	X-SODO287824	1,495
29	84	24	X-SODO288424	1,539
29	42	30	X-SODO284230	1,349
29	48	30	X-SODO284830	1,395
29	54	30	X-SODO285430	1,443
29	60	30	X-SODO286030	1,490
29	66	30	X-SODO286630	1,539
29	72	30	X-SODO287230	1,587
29	78	30	X-SODO287830	1,635
29	84	30	X-SODO288430	1,683
29	42	36	X-SODO284236	1,409
29	48	36	X-SODO284836	1,503
29	54	36	X-SODO285436	1,555
29	60	36	X-SODO286036	1,610
29	66	36	X-SODO286636	1,664
29	72	36	X-SODO287236	1,717
29	78	36	X-SODO287836	1,772
29	84	36	X-SODO288436	1,825

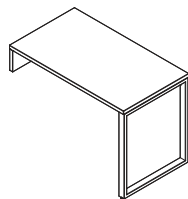

Specify

Notes

- Laminate Selection for Worksurface
- Laminate Selection for Worksurface Riser
- Edgeband Selection
- Paint Selection for Leg (+25 for Grade C)

- O-Legs are constructed from 1 x 2 painted steel.
- Legs have 1 1/2" leveling glides.
- Features a laminate riser.
- Stack on Desks are designed to be stacked on 21" high floor storage or 21" high Calibrate Community spine beams to serve as run-off desks perpendicular to spines.

Rectangular and Round Corner Rectangular Table Desks (Fixed and Mobile)

2MM EDGE RECTANGULAR TABLES WITH TAPERED POST LEGS						
			Without Casters		With Casters	
D	W	H	Model Number	List	Model Number	List
30	48	29	T-RCR304829TPG	1,842	T-RCR304829TPC	1,721
30	54	29	T-RCR305429TPG	1,884	T-RCR305429TPC	1,762
30	60	29	T-RCR306029TPG	1,925	T-RCR306029TPC	1,804
30	66	29	T-RCR306629TPG	1,969	T-RCR306629TPC	1,847
30	72	29	T-RCR307229TPG	2,013	T-RCR307229TPC	1,888
30	78	29	T-RCR307829TPG	2,488	T-RCR307829TPC	2,541
36	72	29	T-RCR367229TPG	2,181	T-RCR367229TPC	2,060
36	78	29	T-RCR367829TPG	2,604	T-RCR367829TPC	2,657

KNIFE EDGE RECTANGULAR TABLES WITH TAPERED POST LEGS						
			Without Casters		With Casters	
D	W	H	Model Number	List	Model Number	List
30	48	29	T-RCK304829TPG	3,203	T-RCK304829TPC	3,097
30	54	29	T-RCK305429TPG	3,263	T-RCK305429TPC	3,159
30	60	29	T-RCK306029TPG	3,327	T-RCK306029TPC	3,222
30	66	29	T-RCK306629TPG	3,462	T-RCK306629TPC	3,358
30	72	29	T-RCK307229TPG	3,536	T-RCK307229TPC	3,434
30	78	29	T-RCK307829TPG	4,106	T-RCK307829TPC	4,157
36	72	29	T-RCK367229TPG	3,663	T-RCK367229TPC	3,557
36	78	29	T-RCK367829TPG	4,299	T-RCK367829TPC	4,353

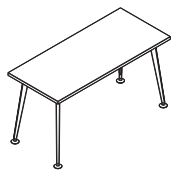

Without Casters

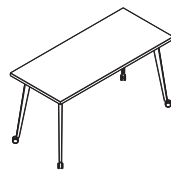

With Casters

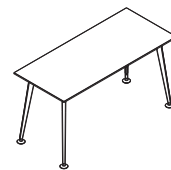

Without Casters

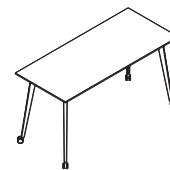

With Casters

2MM EDGE ROUND CORNER RECTANGULAR TABLE WITH TAPERED POST LEGS						
			Without Casters		With Casters	
D	W	H	Model Number	List	Model Number	List
30	48	29	T-RRR304829TPG	2,299	T-RRR304829TPC	2,353
30	54	29	T-RRR305429TPG	2,364	T-RRR305429TPC	2,413
30	60	29	T-RRR306029TPG	2,428	T-RRR306029TPC	2,478
30	66	29	T-RRR306629TPG	2,489	T-RRR306629TPC	2,542
30	72	29	T-RRR307229TPG	2,575	T-RRR307229TPC	2,628
30	78	29	T-RRR307829TPG	2,625	T-RRR307829TPC	2,675
36	72	29	T-RRR367229TPG	2,629	T-RRR367229TPC	2,681
36	78	29	T-RRR367829TPG	2,743	T-RRR367829TPC	2,793

KNIFE EDGE ROUND CORNER RECTANGULAR TABLE WITH TAPERED POST LEGS						
			Without Casters		With Casters	
D	W	H	Model Number	List	Model Number	List
30	48	29	T-RRK304829TPG	3,827	T-RRK304829TPC	3,879
30	54	29	T-RRK305429TPG	3,905	T-RRK305429TPC	3,958
30	60	29	T-RRK306029TPG	3,984	T-RRK306029TPC	4,034
30	66	29	T-RRK306629TPG	4,060	T-RRK306629TPC	4,111
30	72	29	T-RRK307229TPG	4,169	T-RRK307229TPC	4,221
30	78	29	T-RRK307829TPG	4,232	T-RRK307829TPC	4,286
36	72	29	T-RRK367229TPG	4,320	T-RRK367229TPC	4,371
36	78	29	T-RRK367829TPG	4,384	T-RRK367829TPC	4,437

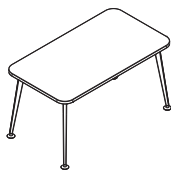

Without Casters

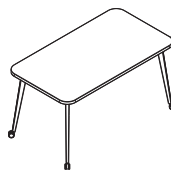

With Casters

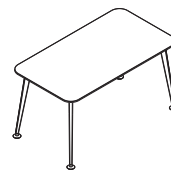

Without Casters

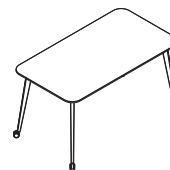

With Casters

Specify

Notes

- Laminate Selection for Worksurface
- Leg Finish

- Casters are locking.

Square Table Desks (Fixed and Mobile)

2MM EDGE SQUARE TABLES WITH TAPERED POST LEGS						
			Without Casters		With Casters	
D	W	H	Model Number	List	Model Number	List
36	36	29	T-SQR363629TPG	1,745	T-SQR363629TPC	1,623
42	42	29	T-SQR424229TPG	1,825	T-SQR424229TPC	1,703
48	48	29	T-SQR484829TPG	2,060	T-SQR484829TPC	1,939
54	54	29	T-SQR545429TPG	2,189	T-SQR545429TPC	2,067
60	60	29	T-SQR606029TPC	2,353	T-SQR606029TPG	2,473

KNIFE EDGE SQUARE TABLES WITH TAPERED POST LEGS						
			Without Casters		With Casters	
D	W	H	Model Number	List	Model Number	List
36	36	29	T-SQK363629TPG	3,097	T-SQK363629TPC	2,992
42	42	29	T-SQK424229TPG	3,230	T-SQK424229TPC	3,127
48	48	29	T-SQK484829TPG	3,516	T-SQK484829TPC	3,410
54	54	29	T-SQK545429TPG	3,712	T-SQK545429TPC	3,609
60	60	29	T-SQK606029TPG	4,060	T-SQK606029TPC	3,955

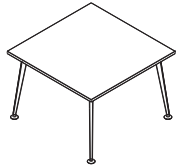

Without Casters

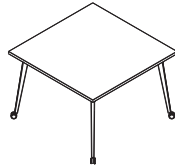

With Casters

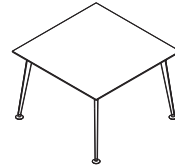

Without Casters

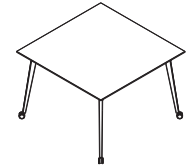

With Casters

2MM EDGE ROUND CORNER SQUARE TABLE WITH TAPERED POST LEGS						
			Without Casters		With Casters	
D	W	H	Model Number	List	Model Number	List
36	36	29	T-SRR363629TPG	2,214	T-SRR363629TPC	2,265
42	42	29	T-SRR424229TPG	2,320	T-SRR424229TPC	2,370
48	48	29	T-SRR484829TPG	2,422	T-SRR484829TPC	2,474
54	54	29	T-SRR545429TPG	2,588	T-SRR545429TPC	2,638
60	60	29	T-SRR606029TPG	2,692	T-SRR606029TPC	2,744

KNIFE EDGE ROUND CORNER SQUARE TABLE WITH TAPERED POST LEGS						
			Without Casters		With Casters	
D	W	H	Model Number	List	Model Number	List
36	36	29	T-SRK363629TPG	3,481	T-SRK363629TPC	3,655
42	42	29	T-SRK424229TPG	3,749	T-SRK424229TPC	3,800
48	48	29	T-SRK484829TPG	3,925	T-SRK484829TPC	3,974
54	54	29	T-SRK545429TPG	4,099	T-SRK545429TPC	4,150
60	60	29	T-SRK606029TPG	4,242	T-SRK606029TPC	4,292

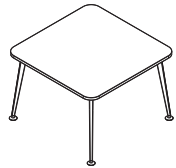

Without Casters



With Casters

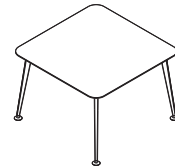

Without Casters

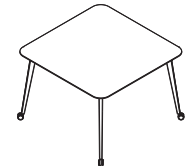

With Casters

Specify

Notes

- Laminate Selection for Worksurface
- Leg Finish

- Casters are locking.

Round and Triangle Table Desks (Fixed and Mobile)

2MM EDGE ROUND TABLE WITH TAPERED POST LEGS

D	W	H	Without Casters		With Casters	
			Model Number	List	Model Number	List
36	36	29	T-RDR3629TPG	1,745	T-RDR3629TPC	1,623
42	42	29	T-RDR4229TPG	1,825	T-RDR4229TPC	1,703
48	48	29	T-RDR4829TPG	1,915	T-RDR4829TPC	1,793
54	54	29	T-RDR5429TPG	2,166	T-RDR5429TPC	2,043
60	60	29	T-RDR6029TPG	2,302	T-RDR6029TPC	2,181



Without Casters



With Casters

KNIFE EDGE ROUND TABLE WITH TAPERED POST LEGS

D	W	H	Without Casters		With Casters	
			Model Number	List	Model Number	List
36	36	29	T-RDK3629TPG	3,097	T-RDK3629TPC	2,992
42	42	29	T-RDK4229TPG	3,230	T-RDK4229TPC	3,127
48	48	29	T-RDK4829TPG	3,390	T-RDK4829TPC	3,286
54	54	29	T-RDK5429TPG	3,694	T-RDK5429TPC	3,588
60	60	29	T-RDK6029TPG	3,913	T-RDK6029TPC	3,810

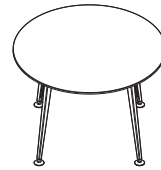

Without Casters



With Casters

2MM EDGE TRIANGLE TABLE WITH TAPERED POST LEGS

D	H	Without Casters		With Casters	
		Model Number	List	Model Number	List
48	29	T-TRR4829TPG	1,902	T-TRR4829TPC	1,780
54	29	T-TRR5429TPG	2,005	T-TRR5429TPC	1,884
60	29	T-TRR6029TPG	2,121	T-TRR6029TPC	1,998



Without Casters



With Casters

KNIFE EDGE TRIANGLE TABLE WITH TAPERED POST LEGS

D	H	Without Casters		With Casters	
		Model Number	List	Model Number	List
48	29	T-TRK4829TPG	3,378	T-TRK4829TPC	3,275
54	29	T-TRK5429TPG	3,557	T-TRK5429TPC	3,451
60	29	T-TRK6029TPG	3,757	T-TRK6029TPC	3,650



Without Casters



With Casters

Specify

- Laminate Selection for Worksurface
- Leg Finish

Notes

- Casters are locking.

Blade Table Desks (Fixed and Mobile)

2MM EDGE BLADE LEFT TABLE WITH TAPERED POST LEGS

D	W	H	Without Casters		With Casters	
			Model Number	List	Model Number	List
30	72	29	T-BLR307229TPG	3,162	T-BLR307229TPC	3,220
30	78	29	T-BLR307829TPG	3,286	T-BLR307829TPC	3,346

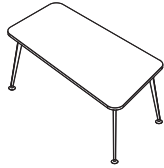

Without Casters



With Casters

KNIFE EDGE BLADE LEFT TABLE WITH TAPERED POST LEGS

D	W	H	Without Casters		With Casters	
			Model Number	List	Model Number	List
30	72	29	T-BLK307229TPG	5,078	T-BLK307229TPC	5,138
30	78	29	T-BLK307829TPG	5,220	T-BLK307829TPC	5,271

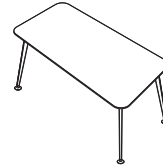

Without Casters

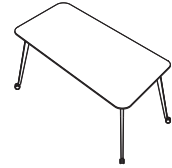

With Casters

2MM EDGE BLADE RIGHT TABLE WITH TAPERED POST LEGS

D	W	H	Without Casters		With Casters	
			Model Number	List	Model Number	List
30	72	29	T-BRR307229TPG	3,162	T-BRR307229TPC	3,220
30	78	29	T-BRR307829TPG	3,286	T-BRR307829TPC	3,346

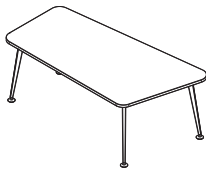

Without Casters

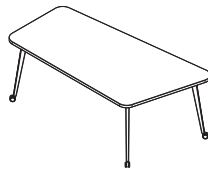

With Casters

KNIFE EDGE BLADE RIGHT TABLE WITH TAPERED POST LEGS

D	W	H	Without Casters		With Casters	
			Model Number	List	Model Number	List
30	72	29	T-BRK307229TPG	5,078	T-BRK307229TPC	5,138
30	78	29	T-BRK307829TPG	5,220	T-BRK307829TPC	5,271

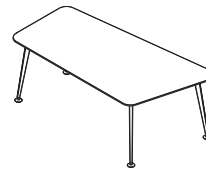

Without Casters

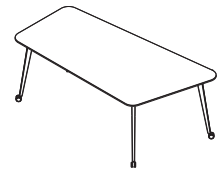

With Casters

Specify

- Laminate Selection for Worksurface
- Leg Finish

Notes

- Casters are locking.

Blade Table Desks with Flat Sides (Fixed and Mobile)

2MM EDGE BLADE TABLE WITH FLAT SIDE AND TAPERED LEGS (LEFT)

			Without Casters		With Casters	
H	W	D	Model Number	List	Model Number	List
29	72	30	T-BFLR307229TPG	2,628	T-BFLR307229TPC	2,679
29	78	30	T-BFLR307829TPG	2,731	T-BFLR307829TPC	2,781

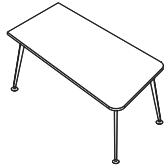

Without Casters
(Blade Right Shown)



With Casters
(Blade Right Shown)

KNIFE EDGE BLADE TABLE WITH FLAT SIDE AND TAPERED LEGS (LEFT)

			Without Casters		With Casters	
H	W	D	Model Number	List	Model Number	List
29	72	30	T-BFLK307229TPG	3,959	T-BFLK307229TPC	4,004
29	78	30	T-BFLK307829TPG	4,071	T-BFLK307829TPC	4,109

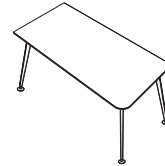

Without Casters
(Blade Right Shown)

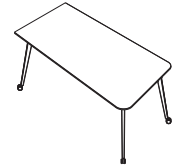

With Casters
(Blade Right Shown)

2MM EDGE BLADE TABLE WITH FLAT SIDE AND TAPERED LEGS (RIGHT)

			Without Casters		With Casters	
H	W	D	Model Number	List	Model Number	List
29	72	30	T-BFRR307229TPG	2,628	T-BFRR307229TPC	2,679
29	78	30	T-BFRR307829TPG	2,731	T-BFRR307829TPC	2,658

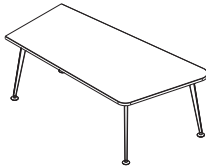

Without Casters
(Blade Left Shown)

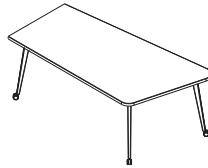

With Casters
(Blade Left Shown)

KNIFE EDGE BLADE TABLE WITH FLAT SIDE AND TAPERED LEGS (RIGHT)

			Without Casters		With Casters	
H	W	D	Model Number	List	Model Number	List
29	72	30	T-BFRK307229TPG	3,959	T-BFRK307229TPC	4,004
29	78	30	T-BFRK307829TPG	4,071	T-BFRK307829TPC	4,109

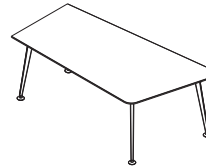

Without Casters
(Blade Left Shown)

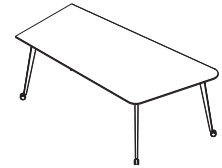

With Casters
(Blade Left Shown)

Specify

- Laminate Selection for Worksurface
- Leg Finish

Notes

- Casters are locking.

Wedge Table Desks (Fixed and Mobile)

2MM EDGE WEDGE TABLE WITH TAPERED LEGS

D	W	H	Without Casters		With Casters	
			Model Number	List	Model Number	List
28	66	29	T-WGR286629TPG	3,176	T-WGR286629TPC	3,236
32	72	29	T-WGR327229TPG	3,365	T-WGR327229TPC	3,425
32	78	29	T-WGR327829TPG	3,468	T-WGR327829TPC	3,527

KNIFE EDGE WEDGE TABLE WITH TAPERED LEGS

D	W	H	Without Casters		With Casters	
			Model Number	List	Model Number	List
28	66	29	T-WGK286629TPG	5,089	T-WGK286629TPC	5,150
32	72	29	T-WGK327229TPG	5,359	T-WGK327229TPC	5,418
32	78	29	T-WGK327829TPG	5,490	T-WGK327829TPC	5,548

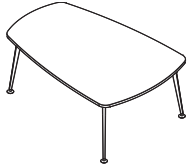

Without Casters

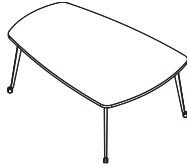

With Casters

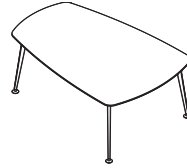

Without Casters

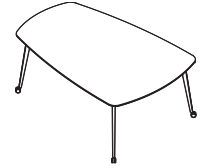

With Casters

Specify

Notes

- Laminate Selection for Worksurface
- Leg Finish

- Casters are locking.

O-Leg Table Desks

2MM EDGE O-LEG TABLE DESKS

D	W	H	Model Number	List
24	48	29	T-RCR244829OLG	2,738
24	54	29	T-RCR245429OLG	2,792
24	60	29	T-RCR246029OLG	2,837
24	66	29	T-RCR246629OLG	2,897
24	72	29	T-RCR247229OLG	2,943
24	78	29	T-RCR247829OLG	3,120
24	84	29	T-RCR248429OLG	3,163
30	48	29	T-RCR304829OLG	2,947
30	54	29	T-RCR305429OLG	3,013
30	60	29	T-RCR306029OLG	3,068
30	66	29	T-RCR306629OLG	3,139
30	72	29	T-RCR307229OLG	3,195
30	78	29	T-RCR307829OLG	3,383
30	84	29	T-RCR308429OLG	3,436
36	48	29	T-RCR364829OLG	3,258
36	54	29	T-RCR365429OLG	3,333
36	60	29	T-RCR366029OLG	3,399
36	66	29	T-RCR366629OLG	3,481
36	72	29	T-RCR367229OLG	3,548
36	78	29	T-RCR367829OLG	3,748
36	84	29	T-RCR368429OLG	3,810

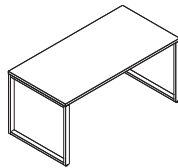

Specify	Notes
<ul style="list-style-type: none"> • Laminate Selection for Worksurface • Color Selection for Edge • Color Selection for Leg 	<ul style="list-style-type: none"> • Steel O-Legs have a 1" x 2" profile. • O-Legs have 1 1/2" leveling glides. • For use with 2mm edgebanding all around the worksurface. • Not sized for use with knife edge work surfaces. • Ships unassembled. • Includes U channel(s) to reinforce the work surface. • Field installed grommets are required to be inset for O-Leg attachment bracket.

Cantilevered Height Adjustable Tables

CANTILEVERED HEIGHT ADJUSTABLE TABLE DESKS					
D	W	Non-Powered		Powered	
		Model Number	List	Model Number	List
24	42	X-CHAA2442	5,616	X-CHAPA2442	6,188
24	48	X-CHAA2448	5,826	X-CHAPA2448	6,426
24	54	X-CHAA2454	6,065	X-CHAPA2454	6,666
24	60	X-CHAA2460	6,141	X-CHAPA2460	6,743
24	66	X-CHAA2466	6,223	X-CHAPA2466	6,824
24	72	X-CHAA2472	6,304	X-CHAPA2472	6,906
30	42	X-CHAA3042	6,225	X-CHAPA3042	6,239
30	48	X-CHAA3048	5,972	X-CHAPA3048	6,478
30	54	X-CHAA3054	6,215	X-CHAPA3054	6,721
30	60	X-CHAA3060	6,296	X-CHAPA3060	6,802
30	66	X-CHAA3066	6,381	X-CHAPA3066	6,888
30	72	X-CHAA3072	6,468	X-CHAPA3072	6,974

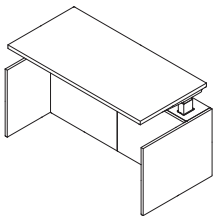

Front

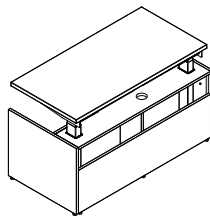

Non-Powered (Back)

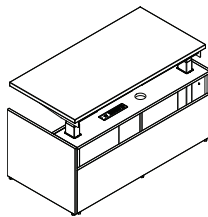

Powered (Back)

Specify

- Laminate Selection for Worksurface
- Laminate Selection for Base
- Paint Selection for Columns - White, Black or Metallic Silver
- Optional Worksurface Grommet Locations (+38)
- Grommet Cover Color (if applicable)

Notes

- Electric with two motors. Motorized base with 1" glide adjustment and 20" height adjustment from 27.5" to 48.5" high, LED programmable hand switch with four memory presets, vertical travel speed is approximately 1.5" per second.
- Features soft collision technology that halts and retracts when table surface meets resistance.
- Supply voltage: 90-127V / 50-60Hz. Nominal voltage: 120V / 60Hz.
- U-channels are 24" shorter than the nominal worksurface width.
- Grommet holes with covers are specified as options.
- All freestanding units have two doors.
- All units include rear access and one grommet.
- Special brackets are included for 36" - 42" wide units.

Cantilevered Height Adjustable Tables with Run-Offs

CANTILEVERED HEIGHT ADJUSTABLE TABLE DESKS FOR 24D LEFT HAND RUN-OFF				
HAT Surface D x W	Non-Powered		Powered	
	Model Number	List	Model Number	List
24 x 36	X-CHALA242436	5,728	X-CHALPA242436	6,323
24 x 72	X-CHALA242442	5,979	X-CHALPA242442	6,578
24 x 48	X-CHALA242448	6,232	X-CHALPA242448	6,833
24 x 54	X-CHALA242454	6,484	X-CHALPA242454	7,084
24 x 60	X-CHALA242460	6,565	X-CHALPA242460	7,166
24 x 66	X-CHALA242466	6,641	X-CHALPA242466	7,243
24 x 72	X-CHALA242472	6,728	X-CHALPA242472	7,329
30 x 36	X-CHALA243036	5,874	X-CHALPA243036	6,468
30 x 42	X-CHALA243042	6,125	X-CHALPA243042	6,722
30 x 48	X-CHALA243048	6,378	X-CHALPA243048	6,978
30 x 54	X-CHALA243054	6,634	X-CHALPA243054	7,234
30 x 60	X-CHALA243060	6,719	X-CHALPA243060	7,321
30 x 66	X-CHALA243066	6,800	X-CHALPA243066	7,402
30 x 72	X-CHALA243072	6,891	X-CHALPA243072	7,492

CANTILEVERED HEIGHT ADJUSTABLE TABLE DESKS FOR 30D LEFT HAND RUN-OFF				
HAT Surface D x W	Non-Powered		Powered	
	Model Number	List	Model Number	List
24 x 36	X-CHALA302436	5,728	X-CHALPA302436	6,329
24 x 72	X-CHALA302442	5,979	X-CHALPA302442	6,581
24 x 48	X-CHALA302448	6,232	X-CHALPA302448	6,833
24 x 54	X-CHALA302454	6,484	X-CHALPA302454	7,084
24 x 60	X-CHALA302460	6,565	X-CHALPA302460	7,166
24 x 66	X-CHALA302466	6,641	X-CHALPA302466	7,243
30 x 36	X-CHALA303036	6,750	X-CHALPA303036	6,475
30 x 42	X-CHALA303042	6,837	X-CHALPA303042	6,727
30 x 48	X-CHALA303048	6,378	X-CHALPA303048	6,978
30 x 54	X-CHALA303054	6,634	X-CHALPA303054	7,234
30 x 60	X-CHALA303060	6,719	X-CHALPA303060	7,321
30 x 66	X-CHALA303066	6,800	X-CHALPA303066	7,402

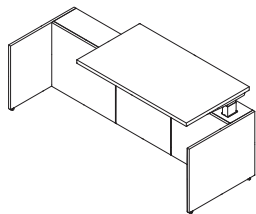

Front (36-48"W)

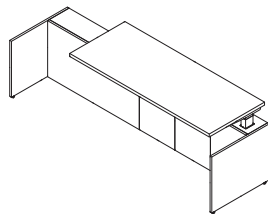

Front (54-72"W)

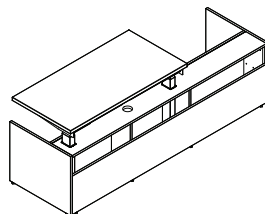

Non-Powered (Back)

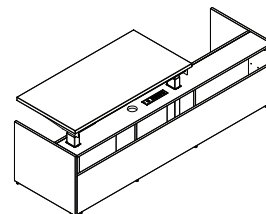

Powered (Back)

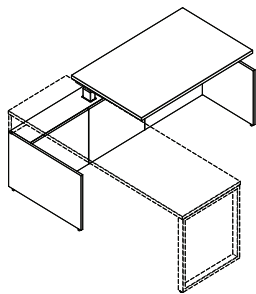

Specify

- Laminate Selection for Worksurface
- Laminate Selection for Base
- Paint Selection for Columns - White, Black or Metallic Silver
- Optional Worksurface Grommet Locations (+38)
- Grommet Cover Color (if applicable)

Notes

- Electric with two motors. Motorized base with 1" glide adjustment and 20" height adjustment from 27.5" to 48.5" high, LED programmable hand switch with four memory presets, vertical travel speed is approximately 1.5" per second.
- Features soft collision technology that halts and retracts when table surface meets resistance.
- Supply voltage: 90-127V / 50-60Hz. Nominal voltage: 120V / 60Hz.
- U-channels are 24" shorter than the nominal worksurface width.
- Grommet holes with covers are specified as options.
- 36" - 48" wide units have one door. 54" - 72" wide units have two doors.
- All units include rear access and one grommet.
- Special brackets are included for 36" - 42" wide units.
- Run-offs sold separately.

Cantilevered Height Adjustable Tables with Run-Offs

CANTILEVERED HEIGHT ADJUSTABLE TABLE DESKS FOR 24D RIGHT HAND RUN-OFF				
HAT Surface D x W	Non-Powered		Powered	
	Model Number	List	Model Number	List
24 x 36	X-CHARA242436	5,728	X-CHARPA242436	6,323
24 x 42	X-CHARA242442	5,979	X-CHARPA242442	6,578
24 x 48	X-CHARA242448	6,232	X-CHARPA242448	6,833
24 x 54	X-CHARA242454	6,484	X-CHARPA242454	7,084
24 x 60	X-CHARA242460	6,565	X-CHARPA242460	7,166
24 x 66	X-CHARA242466	6,641	X-CHARPA242466	7,243
24 x 72	X-CHARA242472	6,728	X-CHARPA242472	7,329
30 x 36	X-CHARA243036	5,874	X-CHARPA243036	6,468
30 x 42	X-CHARA243042	6,125	X-CHARPA243042	6,722
30 x 48	X-CHARA243048	6,378	X-CHARPA243048	6,978
30 x 54	X-CHARA243054	6,634	X-CHARPA243054	7,234
30 x 60	X-CHARA243060	6,719	X-CHARPA243060	7,321
30 x 66	X-CHARA243066	6,800	X-CHARPA243066	7,402
30 x 72	X-CHARA243072	6,891	X-CHARPA243072	7,492

CANTILEVERED HEIGHT ADJUSTABLE TABLE DESKS FOR 30D RIGHT HAND RUN-OFF				
HAT Surface D x W	Non-Powered		Powered	
	Model Number	List	Model Number	List
24 x 36	X-CHARA302436	5,728	X-CHARPA302436	6,329
24 x 42	X-CHARA302442	5,979	X-CHARPA302442	6,581
24 x 48	X-CHARA302448	6,232	X-CHARPA302448	6,833
24 x 54	X-CHARA302454	6,484	X-CHARPA302454	7,084
24 x 60	X-CHARA302460	6,565	X-CHARPA302460	7,166
24 x 66	X-CHARA302466	6,641	X-CHARPA302466	7,243
30 x 36	X-CHARA303036	6,750	X-CHARPA303036	6,475
30 x 42	X-CHARA303042	6,837	X-CHARPA303042	6,727
30 x 48	X-CHARA303048	6,378	X-CHARPA303048	6,978
30 x 54	X-CHARA303054	6,634	X-CHARPA303054	7,234
30 x 60	X-CHARA303060	6,719	X-CHARPA303060	7,321
30 x 66	X-CHARA303066	6,800	X-CHARPA303066	7,402

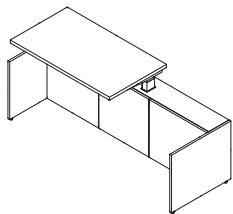

Front (36-48"W)

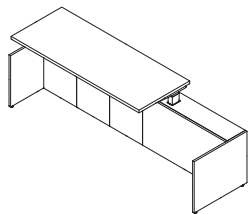

Front (54-72"W)

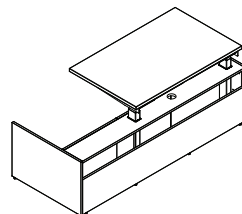

Non-Powered (Back)

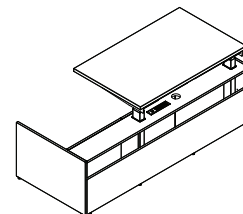

Powered (Back)

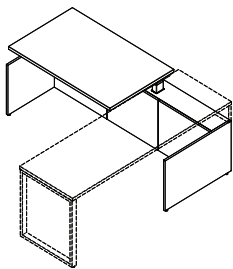

Specify

- Laminate Selection for Worksurface
- Laminate Selection for Base
- Paint Selection for Columns - White, Black or Metallic Silver
- Optional Worksurface Grommet Locations (+38)
- Grommet Cover Color (if applicable)

Notes

- Electric with two motors. Motorized base with 1" glide adjustment and 20" height adjustment from 27.5" to 48.5" high, LED programmable hand switch with four memory presets, vertical travel speed is approximately 1.5" per second.
- Features soft collision technology that halts and retracts when table surface meets resistance.
- Supply voltage: 90-127V / 50-60Hz. Nominal voltage: 120V / 60Hz.
- U-channels are 24" shorter than the nominal worksurface width.
- Grommet holes with covers are specified as options.
- 36" - 48" wide units have one door. 54" - 72" wide units have two doors.
- All units include rear access and one grommet.
- Special brackets are included for 36" - 42" wide units.
- Run-offs sold separately.

3-Leg Cantilevered Height Adjustable Table Desks

3-LEG CANTILEVERED HEIGHT ADJUSTABLE TABLE DESK WITH POWER

HAT Surface D x W	Return	Main Surface Left Model Number	Main Surface Right Model Number	List
30 x 60	24 x 36	X-CH3LPA243660	X-CH3RPA243660	9,135
30 x 60	24 x 42	X-CH3LPA244260	X-CH3RPA244260	9,231
30 x 60	24 x 48	X-CH3LPA244860	X-CH3RPA244860	9,308
30 x 66	24 x 36	X-CH3LPA243666	X-CH3RPA243666	9,173
30 x 66	24 x 42	X-CH3LPA244266	X-CH3RPA244266	9,253
30 x 66	24 x 48	X-CH3LPA244866	X-CH3RPA244866	9,330
30 x 72	24 x 36	X-CH3LPA243672	X-CH3RPA243672	9,195
30 x 72	24 x 42	X-CH3LPA244272	X-CH3RPA244272	9,273
30 x 72	24 x 48	X-CH3LPA244872	X-CH3RPA244872	9,350

3-LEG CANTILEVERED HEIGHT ADJUSTABLE TABLE DESK WITH POWER

HAT Surface D x W	Return	Main Surface Left Model Number	Main Surface Right Model Number	List
30 x 60	30 x 36	X-CH3LPA303660	X-CH3RPA303660	8,422
30 x 60	30 x 42	X-CH3LPA304260	X-CH3RPA304260	8,524
30 x 60	30 x 48	X-CH3LPA304860	X-CH3RPA304860	9,455
30 x 66	30 x 36	X-CH3LPA303666	X-CH3RPA303666	8,461
30 x 66	30 x 42	X-CH3LPA304266	X-CH3RPA304266	8,544
30 x 66	30 x 48	X-CH3LPA304866	X-CH3RPA304866	9,475
30 x 72	30 x 36	X-CH3LPA303672	X-CH3RPA303672	8,482
30 x 72	30 x 42	X-CH3LPA304272	X-CH3RPA304272	8,565
30 x 72	30 x 48	X-CH3LPA304872	X-CH3RPA304872	9,497

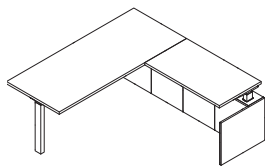

Front

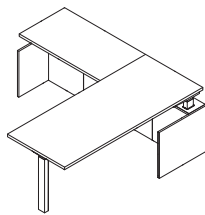

Front

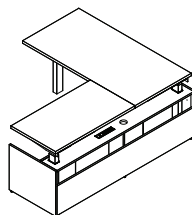

Powered (Back)

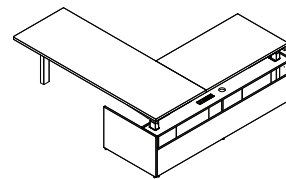

Powered (Back)

Specify

- Laminate Selection for Worksurface
- Laminate Selection for Base
- Paint Selection for Columns - White, Black or Metallic Silver
- Optional Worksurface Grommet Locations (+38)
- Grommet Cover Color (if applicable)

Notes

- Electric with two motors. Motorized base with 1" glide adjustment and 20" height adjustment from 27.5" to 48.5" high, LED programmable hand switch with four memory presets, vertical travel speed is approximately 1.5" per second.
- Features soft collision technology that halts and retracts when table surface meets resistance.
- Supply voltage: 90-127V / 50-60Hz. Nominal voltage: 120V / 60Hz.
- U-channels are 24" shorter than the nominal worksurface width.
- Grommet holes with covers are specified as options.
- All freestanding units have two doors.
- All units include rear access and one grommet.
- Stand alone foot or height-adjustable base/storage sold separately.

3-Leg Cantilevered Height Adjustable Table Desks

3-LEG CANTILEVERED HEIGHT ADJUSTABLE TABLE DESK WITHOUT POWER

HAT Surface D x W	Return	Main Surface Left	Main Surface Right	List
		Model Number	Model Number	
30 x 60	24 x 36	X-CH3LA243660	X-CH3RA243660	8,534
30 x 60	24 x 42	X-CH3LA244260	X-CH3RA244260	8,631
30 x 60	24 x 48	X-CH3LA244860	X-CH3RA244860	7,951
30 x 66	24 x 36	X-CH3LA243666	X-CH3RA243666	8,572
30 x 66	24 x 42	X-CH3LA244266	X-CH3RA244266	8,651
30 x 66	24 x 48	X-CH3LA244866	X-CH3RA244866	7,972
30 x 72	24 x 36	X-CH3LA243672	X-CH3RA243672	8,593
30 x 72	24 x 42	X-CH3LA244272	X-CH3RA244272	8,672
30 x 72	24 x 48	X-CH3LA244872	X-CH3RA244872	7,994

3-LEG CANTILEVERED HEIGHT ADJUSTABLE TABLE DESK WITHOUT POWER

HAT Surface D x W	Return	Main Surface Left	Main Surface Right	List
		Model Number	Model Number	
30 x 60	30 x 36	X-CH3LA303660	X-CH3RA303660	7,822
30 x 60	30 x 42	X-CH3LA304260	X-CH3RA304260	7,922
30 x 60	30 x 48	X-CH3LA304860	X-CH3RA304860	8,853
30 x 66	30 x 36	X-CH3LA303666	X-CH3RA303666	7,860
30 x 66	30 x 42	X-CH3LA304266	X-CH3RA304266	7,943
30 x 66	30 x 48	X-CH3LA304866	X-CH3RA304866	8,875
30 x 72	30 x 36	X-CH3LA303672	X-CH3RA303672	7,880
30 x 72	30 x 42	X-CH3LA304272	X-CH3RA304272	7,964
30 x 72	30 x 48	X-CH3LA304872	X-CH3RA304872	8,895

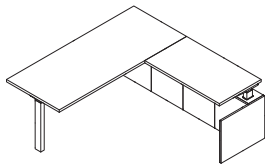

Front

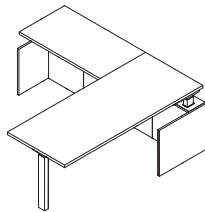

Front

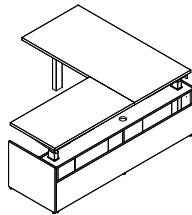

Non-Powered (Back)

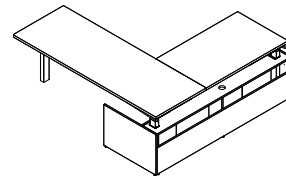

Non-Powered (Back)

Specify

- Laminate Selection for Worksurface
- Laminate Selection for Base
- Paint Selection for Columns - White, Black or Metallic Silver
- Optional Worksurface Grommet Locations (+38)
- Grommet Cover Color (if applicable)

Notes

- Electric with two motors. Motorized base with 1" glide adjustment and 20" height adjustment from 27.5" to 48.5" high, LED programmable hand switch with four memory presets, vertical travel speed is approximately 1.5" per second.
- Features soft collision technology that halts and retracts when table surface meets resistance.
- Supply voltage: 90-127V / 50-60Hz. Nominal voltage: 120V / 60Hz.
- U-channels are 24" shorter than the nominal worksurface width.
- Grommet holes with covers are specified as options.
- All freestanding units have two doors.
- All units include rear access and one grommet.
- Special brackets are included for 36" - 42" wide units.
- Stand alone foot or height-adjustable base/storage sold separately.

Cantilevered Height Adjustable Table Assembly Doors

Cantilevered Height Adjustable Table Assembly Door Locations

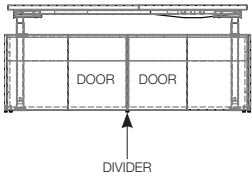
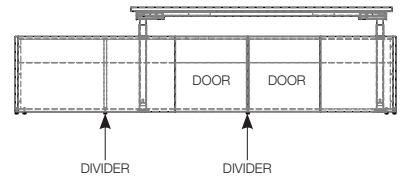
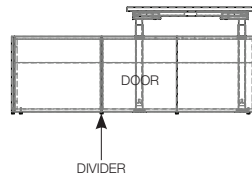
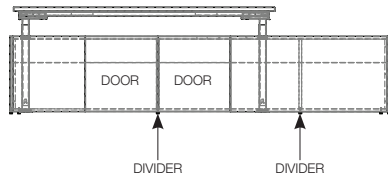
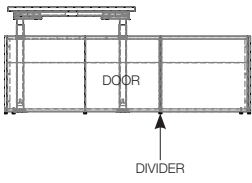
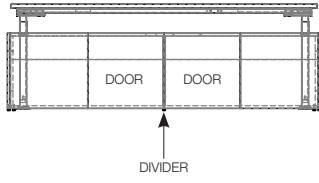
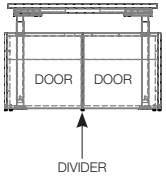

Enclosed Based Single Stage Height Adjustable Table Desks

SQUARE EDGE EXECUTIVE HEIGHT ADJUSTABLE DESK					
		Without Modesty		With Fixed Modesty	
W	D	Model Number	List	Model Number	List
42	24	X-HAT2SE2442	5,541	X-HAT2SFE2442	5,786
48	24	X-HAT2SE2448	5,670	X-HAT2SFE2448	5,896
54	24	X-HAT2SE2454	5,798	X-HAT2SFE2454	6,009
60	24	X-HAT2SE2460	5,831	X-HAT2SFE2460	6,053
66	24	X-HAT2SE2466	5,935	X-HAT2SFE2466	6,167
72	24	X-HAT2SE2472	6,024	X-HAT2SFE2472	6,269
78	24	X-HAT2SE2478	6,101	X-HAT2SFE2478	6,358
84	24	X-HAT2SE2484	6,180	X-HAT2SFE2484	6,433
90	24	X-HAT2SE2490	6,691	X-HAT2SFE2490	6,939
96	24	X-HAT2SE2496	6,800	X-HAT2SFE2496	7,042
42	30	X-HAT2SE3042	5,888	X-HAT2SFE3042	6,131
48	30	X-HAT2SE3048	6,010	X-HAT2SFE3048	6,235
54	30	X-HAT2SE3054	6,129	X-HAT2SFE3054	6,339
60	30	X-HAT2SE3060	6,162	X-HAT2SFE3060	6,383
66	30	X-HAT2SE3066	6,275	X-HAT2SFE3066	6,509
72	30	X-HAT2SE3072	6,371	X-HAT2SFE3072	6,615
78	30	X-HAT2SE3078	6,568	X-HAT2SFE3078	6,825
84	30	X-HAT2SE3084	6,756	X-HAT2SFE3084	7,005
90	30	X-HAT2SE3090	7,374	X-HAT2SFE3090	7,620
96	30	X-HAT2SE3096	7,590	X-HAT2SFE3096	7,830

KNIFE EDGE EXECUTIVE HEIGHT ADJUSTABLE DESK					
		Without Modesty		With Fixed Modesty	
W	D	Model Number	List	Model Number	List
42	24	X-HAT2KE2442	5,825	X-HAT2KFE2442	6,068
48	24	X-HAT2KE2448	6,038	X-HAT2KFE2448	6,266
54	24	X-HAT2KE2454	6,250	X-HAT2KFE2454	6,460
60	24	X-HAT2KE2460	6,273	X-HAT2KFE2460	6,493
66	24	X-HAT2KE2466	6,447	X-HAT2KFE2466	6,679
72	24	X-HAT2KE2472	6,583	X-HAT2KFE2472	6,828
78	24	X-HAT2KE2478	6,701	X-HAT2KFE2478	6,959
84	24	X-HAT2KE2484	6,822	X-HAT2KFE2484	7,072
90	24	X-HAT2KE2490	7,375	X-HAT2KFE2490	7,620
96	24	X-HAT2KE2496	7,525	X-HAT2KFE2496	7,767
42	30	X-HAT2KE3042	6,281	X-HAT2KFE3042	6,525
48	30	X-HAT2KE3048	6,480	X-HAT2KFE3048	6,707
54	30	X-HAT2KE3054	6,679	X-HAT2KFE3054	6,889
60	30	X-HAT2KE3060	6,709	X-HAT2KFE3060	6,931
66	30	X-HAT2KE3066	6,893	X-HAT2KFE3066	7,126
72	30	X-HAT2KE3072	7,042	X-HAT2KFE3072	7,287
78	30	X-HAT2KE3078	7,383	X-HAT2KFE3078	7,640
84	30	X-HAT2KE3084	7,702	X-HAT2KFE3084	7,953
90	30	X-HAT2KE3090	8,454	X-HAT2KFE3090	8,700
96	30	X-HAT2KE3096	8,802	X-HAT2KFE3096	9,044

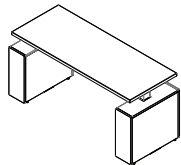

Without Modesty

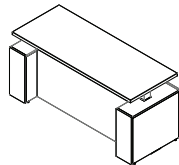

With Modesty

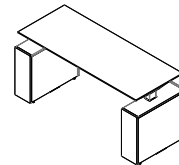

Without Modesty

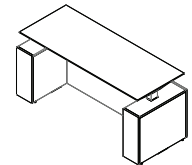

With Modesty

Specify

- Laminate Selection for Worksurface
- Laminate Selection for Base and Modesty
- Paint Selection for Columns - White, Black or Metallic Silver
- Additional Grommet Locations (+38)
- Grommet Cover Color (if applicable)

Notes

- Electric with two motors. Motorized base with 1” glide adjustment and 20” height adjustment from 27.5” to 48.5” high, LED programmable hand switch with four memory presets, vertical travel speed is approximately 1.5” per second.
- Features soft collision technology that halts and retracts when table surface meets resistance.
- Supply voltage: 90-127V / 50-60Hz. Nominal voltage: 120V / 60Hz.
- Knife edge featured on all four side of desk.
- Worksurfaces that are 30” deep and have a width of 60 or wider will come with two u-channels to stiffen the work surface.
- U-channels are 24” shorter than the nominal worksurface width.
- Grommet holes with covers are specified as options.

Telescoping Height Adjustable Executive Desks

TELESCOPING HEIGHT ADJUSTABLE EXECUTIVE DESKS WITH 2MM EDGE WORKSURFACES

D	W	Model Number	List	Grade C Laminate (Worksurface Only)
30	60	T-THATRE3060	7,661	+50
30	66	T-THATRE3066	7,810	+56
30	72	T-THATRE3072	7,938	+61
30	78	T-THATRE3078	8,191	+69
30	84	T-THATRE3084	8,407	+87
36	60	T-THATRE3660	8,044	+68
36	66	T-THATRE3666	8,201	+72
36	72	T-THATRE3672	8,335	+80
36	78	T-THATRE3678	8,598	+88
36	84	T-THATRE3684	8,827	+96

TELESCOPING HEIGHT ADJUSTABLE EXECUTIVE DESKS WITH KNIFE EDGE WORKSURFACES

D	W	Model Number	List	Grade C Laminate (Worksurface Only)
36	60	T-THATKE3660	8,316	+68
36	66	T-THATKE3666	8,551	+72
36	72	T-THATKE3672	8,745	+80
36	78	T-THATKE3678	9,168	+88
36	84	T-THATKE3684	9,543	+96

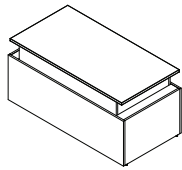

Front View

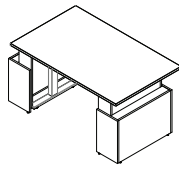

Back View

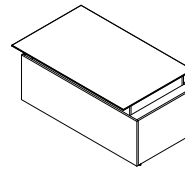

Front View

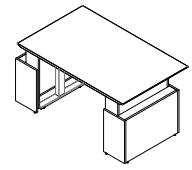

Back View

Specify

- Laminate Selection for Worksurface
- Laminate Selection for Base (includes telescoping modesties)
- Paint Selection for Columns - White, Black or Metallic Silver

Notes

- Electric with three motors and three legs. Height range adjustment from 27.5" to 48.5" high, LED programmable hand switch with four memory presets, vertical travel speed is approximately 1.8" per second.
- Features soft collision technology that halts and retracts when table surface meets resistance.
- Knife edge option featured on three sides of desk (approach and two sides), user edge is 2mm.
- Lifiting capacity of 200 lbs including worksurface and enclosure.
- Grain direction runs vertical for desks up to 60" wide, desks wider than 60" feature a horizontal grain.

Height Adjustable Table Bases

HEIGHT ADJUSTABLE TABLE BASE

H	W	D	Model Number	List
21	8	24	X-HBE24	1,452
21	8	30	X-HBE30	1,591

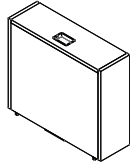

Specify	Notes
<ul style="list-style-type: none"> Laminate Selection for Case 	<ul style="list-style-type: none"> Bases are only compatible with Calibrate Height Adjustable Tables

BOX-FILE HEIGHT ADJUSTABLE TABLE BASE

H	W	D	Hole Left	Hole Right	List
			Model Number	Model Number	
21	23	24	X-HBE24L	X-HBE24R	2,248
21	23	30	X-HBE30L	X-HBE30R	2,389

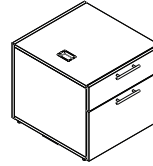

Hole Left

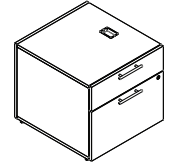

Hole Right

Specify	Notes
<ul style="list-style-type: none"> Laminate Selection for Case Laminate Selection for Face/Drawer Handle Selection 	<ul style="list-style-type: none"> Units contain standard pedestal drawer sizes and can be used with pedestal accessories. Bases are only compatible with Calibrate Height Adjustable Tables

21" High Fixed Modesty HAT Base

FIXED MODESTY HAT BASE TO HAT BASE

H	W	For Use With	Model Number	List
21	42	42W Top	X-HATMTHB2142	810
21	48	48W Top	X-HATMTHB2148	821
21	54	54W Top	X-HATMTHB2154	834
21	60	60W Top	X-HATMTHB2160	845
21	66	66W Top	X-HATMTHB2166	857
21	72	72W Top	X-HATMTHB2172	868
21	78	78W Top	X-HATMTHB2178	881
21	84	84W Top	X-HATMTHB2184	891
21	90	90W Top	X-HATMTHB2190	902
21	96	96W Top	X-HATMTHB2196	913

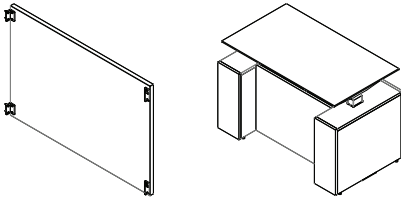

FIXED MODESTY HAT BASE 18" TO HAT BASE

H	W	D	For Use With	Model Number	List
21	60	18	60W Top	X-HATMB18D60	834
21	66	18	66W Top	X-HATMB18D66	845
21	72	18	72W Top	X-HATMB18D72	857
21	78	18	78W Top	X-HATMB18D78	868
21	84	18	84W Top	X-HATMB18D84	881
21	90	18	90W Top	X-HATMB18D90	891
21	96	18	96W Top	X-HATMB18D96	902
21	66	24	66W Top	X-HATMB24D66	845
21	72	24	72W Top	X-HATMB24D72	857
21	78	24	78W Top	X-HATMB24D78	868
21	84	24	84W Top	X-HATMB24D84	881
21	90	24	90W Top	X-HATMB24D90	891
21	96	24	96W Top	X-HATMB24D96	902

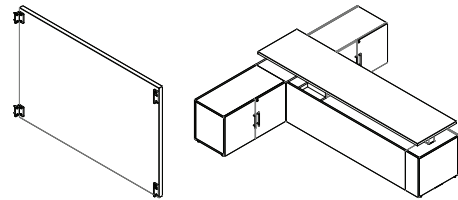

FIXED MODESTY HAT BASE TO BOX FILE HAT BASE

H	W	For Use With	Model Number	List
21	60	60W Top	X-HATMTBF2160	821
21	66	66W Top	X-HATMTBF2166	834
21	72	72W Top	X-HATMTBF2172	845
21	78	78W Top	X-HATMTBF2178	857
21	84	84W Top	X-HATMTBF2184	868
21	90	90W Top	X-HATMTBF2190	881
21	96	96W Top	X-HATMTBF2196	891

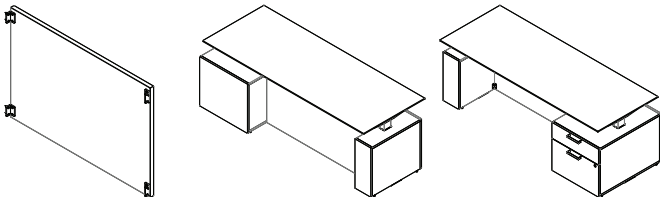

Specify

• Laminates Selection

Notes

- This optional modesty panel can be specified on the height adjustable table desk.
- Vertical grain for sizes up to 66" wide.
- Horizontal grain for sizes 72" to 96" wide.
- Fastens to laminate bases using provided L brackets and screws.

Height Adjustable Table Bases

POWERED HEIGHT ADJUSTABLE TABLE BASE

H	W	D	Without Side Access		With Side Access	
			Model Number	List	Model Number	List
21	24	18	X-HBPE2418	2,748	X-HBPE-BA2418	2,901
21	24	24	X-HBPE2424	2,766	X-HBPE-BA2424	2,921
21	30	18	X-HBPE3018	2,887	X-HBPE-BA3018	3,042
21	30	24	X-HBPE3024	2,907	X-HBPE-BA3024	3,061

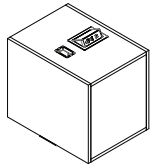

Without Side Access

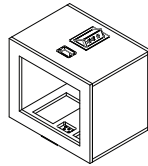

With Side Access

NON-POWERED HEIGHT ADJUSTABLE TABLE BASE

H	W	D	Without Side Access		With Side Access	
			Model Number	List	Model Number	List
21	24	18	X-HBE2418	1,547	X-HBE-BA2418	1,701
21	24	24	X-HBE2424	1,565	X-HBE-BA2424	1,721
21	30	18	X-HBE3018	1,686	X-HBE-BA3018	1,841
21	30	24	X-HBE3024	1,706	X-HBE-BA3024	1,859

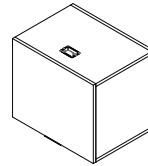

Without Side Access

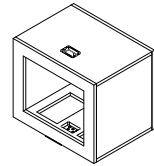

With Side Access

- | Specify | Notes |
|---------|-------|
|---------|-------|
- Laminate Selection for Case
 - Color Selection for Power Unit
- Side Access for use against wall or panel.
 - Powered unit includes Ashley Duo Air (two AC outlets and two USB ports).
 - Bases are only compatible with Calibrate Height Adjustable Tables.
 - Unit has removable front for easy access.
 - Access panel opening 3" less than the overall height/width of the unit.

- | Specify | Notes |
|---------|-------|
|---------|-------|
- Laminate Selection for Case
- Side Access for use against wall or panel.
 - Bases are only compatible with Calibrate Height Adjustable Tables.
 - Unit has removable front for easy access.
 - Access panel opening 3" less than the overall height/width of the unit.

HEIGHT ADJUSTABLE TABLE BASE WITH BOOKCASE

H	W	D	Without Side Access		With Side Access	
			Model Number	List	Model Number	List
21	24	18	X-HBBCE2418	1,910	X-HBBCE-BA2418	2,064
21	24	24	X-HBBCE2424	1,933	X-HBBCE-BA2424	2,085
21	30	18	X-HBBCE3018	1,977	X-HBBCE-BA3018	2,130
21	30	24	X-HBBCE3024	1,997	X-HBBCE-BA3024	2,151

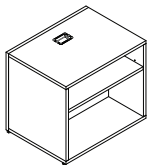

Without Side Access (Front)

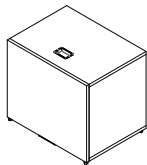

Without Side Access (Back)

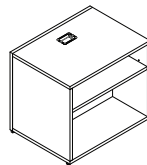

With Side Access (Front)

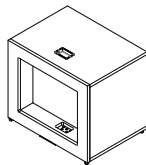

With Side Access (Back)

- | Specify | Notes |
|---------|-------|
|---------|-------|
- Laminate Selection for Case
- Side Access for use against wall or panel.
 - Bases are only compatible with Calibrate Height Adjustable Tables.
 - Access panel opening 3" less than the overall height/width of the unit.

Height Adjustable Table Legs and Worksurfaces

HEIGHT ADJUSTABLE 2-LEG BASES WITH 2MM EDGE WORKSURFACES				
D	W	Model Number	List	Grade C Laminate
24	48	X-2HSE2448	2,950	+33
24	54	X-2HSE2454	3,005	+41
24	60	X-2HSE2460	3,024	+41
24	66	X-2HSE2466	3,045	+46
24	72	X-2HSE2472	3,066	+51
24	78	X-2HSE2478	3,087	+54
24	84	X-2HSE2484	3,109	+58
30	48	X-2HSE3048	3,024	+46
30	54	X-2HSE3054	3,050	+50
30	60	X-2HSE3060	3,075	+50
30	66	X-2HSE3066	3,102	+56
30	72	X-2HSE3072	3,126	+61
30	78	X-2HSE3078	3,148	+69
30	84	X-2HSE3084	3,169	+87

HEIGHT ADJUSTABLE 2-LEG BASES WITH KNIFE EDGE WORKSURFACES				
D	W	Model Number	List	Grade C Laminate
24	48	X-2HKE2448	3,192	+33
24	54	X-2HKE2454	3,213	+41
24	60	X-2HKE2460	3,235	+41
24	66	X-2HKE2466	3,257	+46
24	72	X-2HKE2472	3,278	+51
24	78	X-2HKE2478	3,300	+54
24	84	X-2HKE2484	3,323	+58
30	48	X-2HKE3048	3,344	+46
30	54	X-2HKE3054	3,366	+50
30	60	X-2HKE3060	3,387	+50
30	66	X-2HKE3066	3,409	+56
30	72	X-2HKE3072	3,431	+61
30	78	X-2HKE3078	3,452	+69
30	84	X-2HKE3084	3,475	+87

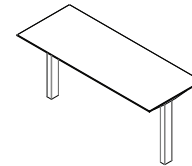
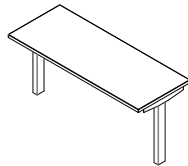

Specify	Notes
<ul style="list-style-type: none"> Laminate Selection for Worksurface Color Selection for Edge Color Selection for Leg - Black, Metallic Silver or White Additional Grommet Locations (+38) Grommet Cover Color (if applicable) 	<ul style="list-style-type: none"> Must be purchased with Height Adjustable Bases, Height Adjustable Storage Bases or Height Adjustable Base Single Foot Kits or Height Adjustable Table Foot Glides to use. 29" to 46" height adjustable range. Supply voltage: 90-127V / 50-60Hz. Nominal voltage: 120V / 60Hz. Sizes are nominal and 1" shorter to accommodate pinch points. Worksurfaces that are 30" deep and have a width of 60 or wider will come with two u-channels to stiffen the work surface. U-channels are 24" shorter than the nominal worksurface width. Grommet holes with covers are specified as options.

Calibrate Height Adjustable Tables

Calibrate 3-Leg Height Adjustable Tables Version 2

CALIBRATE 3-LEG HEIGHT ADJUSTABLE TABLES VERSION 2 MAIN SURFACE RIGHT, RETURN LEFT, 2MM EDGE						
D ¹ Actual	W ¹ Actual	D ² Actual	W ² Actual	Model Number	List	Grade C Laminate
29	46	23	41	X-3HSEL30482442	5,601	+33/+39
29	46	23	47	X-3HSEL30482448	5,675	+33/+46
29	46	23	53	X-3HSEL30482454	5,795	+33/+50
29	46	23	59	X-3HSEL30482460	5,828	+33/+50
29	46	23	65	X-3HSEL30482466	5,942	+33/+56
29	46	23	71	X-3HSEL30482472	6,037	+33/+61
29	52	23	41	X-3HSEL30542442	5,729	+41/+39
29	52	23	47	X-3HSEL30542448	5,804	+41/+46
29	52	23	53	X-3HSEL30542454	5,925	+41/+50
29	52	23	59	X-3HSEL30542460	5,958	+41/+50
29	52	23	65	X-3HSEL30542466	6,070	+41/+56
29	52	23	71	X-3HSEL30542472	6,166	+41/+61
29	58	23	41	X-3HSEL30602442	5,761	+41/+39
29	58	23	47	X-3HSEL30602448	5,836	+41/+46
29	58	23	53	X-3HSEL30602454	5,958	+41/+50
29	58	23	59	X-3HSEL30602460	5,990	+41/+50
29	58	23	65	X-3HSEL30602466	6,101	+41/+56
29	58	23	71	X-3HSEL30602472	6,198	+41/+61
29	64	23	41	X-3HSEL30662442	5,865	+46/+39
29	64	23	47	X-3HSEL30662448	5,939	+46/+46
29	64	23	53	X-3HSEL30662454	6,060	+46/+50
29	64	23	59	X-3HSEL30662460	6,093	+46/+50
29	64	23	65	X-3HSEL30662466	6,206	+46/+56
29	64	23	71	X-3HSEL30662472	6,301	+46/+61

CALIBRATE 3-LEG HEIGHT ADJUSTABLE TABLES VERSION 2 MAIN SURFACE LEFT, RETURN RIGHT, 2MM EDGE						
D ¹ Actual	W ¹ Actual	D ² Actual	W ² Actual	Model Number	List	Grade C Laminate
29	46	23	41	X-3HSER30482442	5,601	+33/+39
29	46	23	47	X-3HSER30482448	5,675	+33/+46
29	46	23	53	X-3HSER30482454	5,795	+33/+50
29	46	23	59	X-3HSER30482460	5,828	+33/+50
29	46	23	65	X-3HSER30482466	5,942	+33/+56
29	46	23	71	X-3HSER30482472	6,037	+33/+61
29	52	23	41	X-3HSER30542442	5,729	+41/+39
29	52	23	47	X-3HSER30542448	5,804	+41/+46
29	52	23	53	X-3HSER30542454	5,925	+41/+50
29	52	23	59	X-3HSER30542460	5,958	+41/+50
29	52	23	65	X-3HSER30542466	6,070	+41/+56
29	52	23	71	X-3HSER30542472	6,166	+41/+61
29	58	23	41	X-3HSER30602442	5,761	+41/+39
29	58	23	47	X-3HSER30602448	5,836	+41/+46
29	58	23	53	X-3HSER30602454	5,958	+41/+50
29	58	23	59	X-3HSER30602460	5,990	+41/+50
29	58	23	65	X-3HSER30602466	6,101	+41/+56
29	58	23	71	X-3HSER30602472	6,198	+41/+61
29	64	23	41	X-3HSER30662442	5,865	+46/+39
29	64	23	47	X-3HSER30662448	5,939	+46/+46
29	64	23	53	X-3HSER30662454	6,060	+46/+50
29	64	23	59	X-3HSER30662460	6,093	+46/+50
29	64	23	65	X-3HSER30662466	6,206	+46/+56
29	64	23	71	X-3HSER30662472	6,301	+46/+61

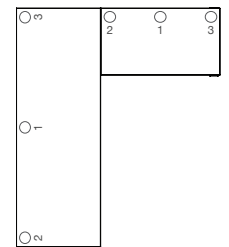
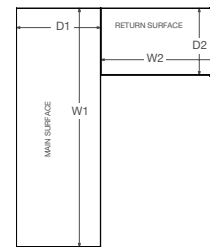
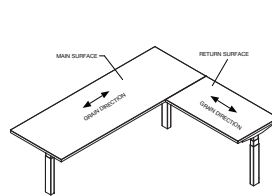
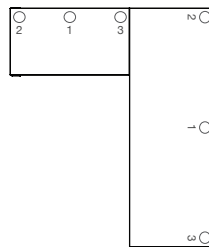
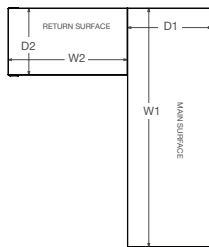
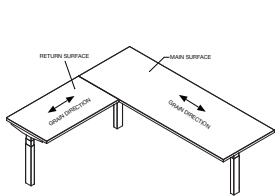

Specify

- Lam. Selection for Main Worksurface
- Lam. Selection for Return Worksurface
- Color Selection for Edge
- Color Selection for Leg - Black, Metallic Silver or White
- Optional Grogmet Locations (+38)
- Grogmet Cover Color (if applicable)

Notes

- **Must be purchased with Height Adjustable Bases, Height Adjustable Storage Bases or Height Adjustable Base Single Foot Kits or Height Adjustable Table Foot Glides to use.**
- 29" to 46" height adjustable range.
- Supply voltage: 90-127V / 50-60Hz. Nominal voltage: 120V / 60Hz.
- Sizes are nominal and 1" shorter to accommodate pinch points.
- Worksurfaces that are 30" deep and have a width of 60 or wider will come with two u-channels to stiffen the work surface.
- U-channels are 24" shorter than the nominal worksurface width.
- Grogmet holes with covers are specified as options.

Calibrate 3-Leg Height Adjustable Tables Version 2

CALIBRATE 3-LEG HEIGHT ADJUSTABLE TABLES VERSION 2 MAIN SURFACE RIGHT, RETURN LEFT, 2MM EDGE						
D ¹ Actual	W ¹ Actual	D ² Actual	W ² Actual	Model Number	List	Grade C Laminate
29	70	23	41	X-3HSEL30722442	5,952	+51/+39
29	70	23	47	X-3HSEL30722448	6,027	+51/+46
29	70	23	53	X-3HSEL30722454	6,149	+51/+50
29	70	23	59	X-3HSEL30722460	6,181	+51/+50
29	70	23	65	X-3HSEL30722466	6,295	+51/+56
29	70	23	71	X-3HSEL30722472	6,389	+51/+61
29	76	23	41	X-3HSEL30782442	6,030	+54/+39
29	76	23	47	X-3HSEL30782448	6,106	+54/+46
29	76	23	53	X-3HSEL30782454	6,227	+54/+50
29	76	23	59	X-3HSEL30782460	6,259	+54/+50
29	76	23	65	X-3HSEL30782466	6,372	+54/+56
29	76	23	71	X-3HSEL30782472	6,466	+54/+61
29	82	23	41	X-3HSEL30842442	6,111	+58/+39
29	82	23	47	X-3HSEL30842448	6,185	+58/+46
29	82	23	53	X-3HSEL30842454	6,307	+58/+50
29	82	23	59	X-3HSEL30842460	6,337	+58/+50
29	82	23	65	X-3HSEL30842466	6,451	+58/+56
29	82	23	71	X-3HSEL30842472	6,546	+58/+61

CALIBRATE 3-LEG HEIGHT ADJUSTABLE TABLES VERSION 2 MAIN SURFACE LEFT, RETURN RIGHT, 2MM EDGE						
D ¹ Actual	W ¹ Actual	D ² Actual	W ² Actual	Model Number	List	Grade C Laminate
29	70	23	41	X-3HSER30722442	5,952	+51/+39
29	70	23	47	X-3HSER30722448	6,027	+51/+46
29	70	23	53	X-3HSER30722454	6,149	+51/+50
29	70	23	59	X-3HSER30722460	6,181	+51/+50
29	70	23	65	X-3HSER30722466	6,295	+51/+56
29	70	23	71	X-3HSER30722472	6,389	+51/+61
29	76	23	41	X-3HSER30782442	6,030	+54/+39
29	76	23	47	X-3HSER30782448	6,106	+54/+46
29	76	23	53	X-3HSER30782454	6,227	+54/+50
29	76	23	59	X-3HSER30782460	6,259	+54/+50
29	76	23	65	X-3HSER30782466	6,372	+54/+56
29	76	23	71	X-3HSER30782472	6,466	+54/+61
29	82	23	41	X-3HSER30842442	6,111	+58/+39
29	82	23	47	X-3HSER30842448	6,185	+58/+46
29	82	23	53	X-3HSER30842454	6,307	+58/+50
29	82	23	59	X-3HSER30842460	6,337	+58/+50
29	82	23	65	X-3HSER30842466	6,451	+58/+56
29	82	23	71	X-3HSER30842472	6,546	+58/+61

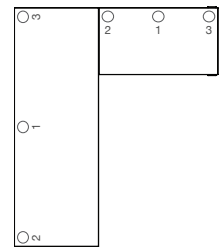
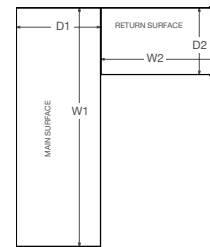
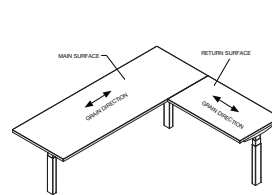
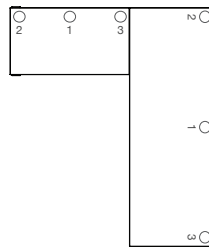
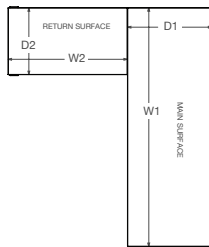
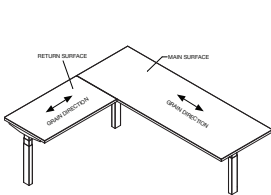

Specify

- Lam. Selection for Main Worksurface
- Lam. Selection for Return Worksurface
- Color Selection for Edge
- Color Selection for Leg - Black, Metallic Silver or White
- Optional Grommet Locations (+38)
- Grommet Cover Color (if applicable)

Notes

- **Must be purchased with Height Adjustable Bases, Height Adjustable Storage Bases or Height Adjustable Base Single Foot Kits or Height Adjustable Table Foot Glides to use.**
- 29" to 46" height adjustable range.
- Supply voltage: 90-127V / 50-60Hz. Nominal voltage: 120V / 60Hz.
- Sizes are nominal and 1" shorter to accommodate pinch points.
- Worksurfaces that are 30" deep and have a width of 60 or wider will come with two u-channels to stiffen the work surface.
- U-channels are 24" shorter than the nominal worksurface width.
- Grommet holes with covers are specified as options.

Calibrate 3-Leg Height Adjustable Tables Version 2

CALIBRATE 3-LEG HEIGHT ADJUSTABLE TABLES VERSION 2 MAIN SURFACE RIGHT, RETURN LEFT, 2MM EDGE						
D ¹ Actual	W ¹ Actual	D ² Actual	W ² Actual	Model Number	List	Grade C Laminate
23	46	29	41	X-3HSEL24483042	5,601	+33/+39
23	46	29	47	X-3HSEL24483048	5,675	+33/+46
23	46	29	53	X-3HSEL24483054	5,795	+33/+50
23	46	29	59	X-3HSEL24483060	5,828	+33/+50
23	46	29	65	X-3HSEL24483066	5,942	+33/+56
23	46	29	71	X-3HSEL24483072	6,037	+33/+61
23	52	29	41	X-3HSEL24543042	5,729	+41/+39
23	52	29	47	X-3HSEL24543048	5,804	+41/+46
23	52	29	53	X-3HSEL24543054	5,925	+41/+50
23	52	29	59	X-3HSEL24543060	5,958	+41/+50
23	52	29	65	X-3HSEL24543066	6,070	+41/+56
23	52	29	71	X-3HSEL24543072	6,166	+41/+61
23	58	29	41	X-3HSEL24603042	5,761	+41/+39
23	58	29	47	X-3HSEL24603048	5,836	+41/+46
23	58	29	53	X-3HSEL24603054	5,958	+41/+50
23	58	29	59	X-3HSEL24603060	5,990	+41/+50
23	58	29	65	X-3HSEL24603066	6,101	+41/+56
23	58	29	71	X-3HSEL24603072	6,198	+41/+61

CALIBRATE 3-LEG HEIGHT ADJUSTABLE TABLES VERSION 2 MAIN SURFACE LEFT, RETURN RIGHT, 2MM EDGE						
D ¹ Actual	W ¹ Actual	D ² Actual	W ² Actual	Model Number	List	Grade C Laminate
23	46	29	41	X-3HSER24483042	5,601	+33/+39
23	46	29	47	X-3HSER24483048	5,675	+33/+46
23	46	29	53	X-3HSER24483054	5,795	+33/+50
23	46	29	59	X-3HSER24483060	5,828	+33/+50
23	46	29	65	X-3HSER24483066	5,942	+33/+56
23	46	29	71	X-3HSER24483072	6,037	+33/+61
23	52	29	41	X-3HSER24543042	5,729	+41/+39
23	52	29	47	X-3HSER24543048	5,804	+41/+46
23	52	29	53	X-3HSER24543054	5,925	+41/+50
23	52	29	59	X-3HSER24543060	5,958	+41/+50
23	52	29	65	X-3HSER24543066	6,070	+41/+56
23	52	29	71	X-3HSER24543072	6,166	+41/+61
23	58	29	41	X-3HSER24603042	5,761	+41/+39
23	58	29	47	X-3HSER24603048	5,836	+41/+46
23	58	29	53	X-3HSER24603054	5,958	+41/+50
23	58	29	59	X-3HSER24603060	5,990	+41/+50
23	58	29	65	X-3HSER24603066	6,101	+41/+56
23	58	29	71	X-3HSER24603072	6,198	+41/+61

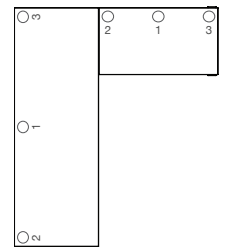
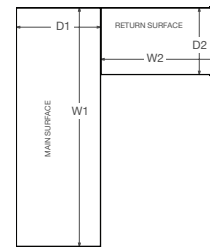
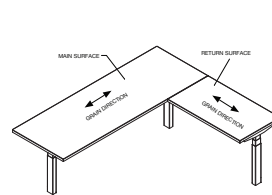
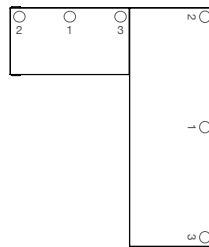
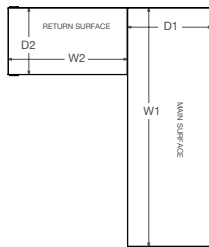
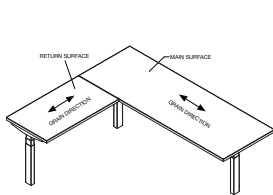

Specify

- Lam. Selection for Main Worksurface
- Lam. Selection for Return Worksurface
- Color Selection for Edge
- Color Selection for Leg - Black, Metallic Silver or White
- Optional Grommet Locations (+38)
- Grommet Cover Color (if applicable)

Notes

- **Must be purchased with Height Adjustable Bases, Height Adjustable Storage Bases or Height Adjustable Base Single Foot Kits or Height Adjustable Table Foot Glides to use.**
- 29" to 46" height adjustable range.
- Supply voltage: 90-127V / 50-60Hz. Nominal voltage: 120V / 60Hz.
- Sizes are nominal and 1" shorter to accommodate pinch points.
- Worksurfaces that are 30" deep and have a width of 60 or wider will come with two u-channels to stiffen the work surface.
- U-channels are 24" shorter than the nominal worksurface width.
- Grommet holes with covers are specified as options.

Calibrate 3-Leg Height Adjustable Tables Version 2

**CALIBRATE 3-LEG HEIGHT ADJUSTABLE TABLES VERSION 2
MAIN SURFACE RIGHT, RETURN LEFT, 2MM EDGE**

D ¹ Actual	W ¹ Actual	D ² Actual	W ² Actual	Model Number	List	Grade C Laminate
23	64	29	41	X-3HSEL24663042	5,865	+46/+39
23	64	29	47	X-3HSEL24663048	5,939	+46/+46
23	64	29	53	X-3HSEL24663054	6,060	+46/+50
23	64	29	59	X-3HSEL24663060	6,093	+46/+50
23	64	29	65	X-3HSEL24663066	6,206	+46/+56
23	64	29	71	X-3HSEL24663072	6,301	+46/+61
23	70	29	41	X-3HSEL24723042	5,952	+51/+39
23	70	29	47	X-3HSEL24723048	6,027	+51/+46
23	70	29	53	X-3HSEL24723054	6,149	+51/+50
23	70	29	59	X-3HSEL24723060	6,181	+51/+50
23	70	29	65	X-3HSEL24723066	6,295	+51/+56
23	70	29	71	X-3HSEL24723072	6,389	+51/+61
23	76	29	41	X-3HSEL24783042	6,030	+54/+39
23	76	29	47	X-3HSEL24783048	6,106	+54/+46
23	76	29	53	X-3HSEL24783054	6,227	+54/+50
23	76	29	59	X-3HSEL24783060	6,259	+54/+50
23	76	29	65	X-3HSEL24783066	6,372	+54/+56
23	76	29	71	X-3HSEL24783072	6,466	+54/+61
23	82	29	41	X-3HSEL24843042	6,111	+58/+39
23	82	29	47	X-3HSEL24843048	6,185	+58/+46
23	82	29	53	X-3HSEL24843054	6,307	+58/+50
23	82	29	59	X-3HSEL24843060	6,337	+58/+50
23	82	29	65	X-3HSEL24843066	6,451	+58/+56
23	82	29	71	X-3HSEL24843072	6,546	+58/+61

**CALIBRATE 3-LEG HEIGHT ADJUSTABLE TABLES VERSION 2
MAIN SURFACE LEFT, RETURN RIGHT, 2MM EDGE**

D ¹ Actual	W ¹ Actual	D ² Actual	W ² Actual	Model Number	List	Grade C Laminate
23	64	29	41	X-3HSER24663042	5,865	+46/+39
23	64	29	47	X-3HSER24663048	5,939	+46/+46
23	64	29	53	X-3HSER24663054	6,060	+46/+50
23	64	29	59	X-3HSER24663060	6,093	+46/+50
23	64	29	65	X-3HSER24663066	6,206	+46/+56
23	64	29	71	X-3HSER24663072	6,301	+46/+61
23	70	29	41	X-3HSER24723042	5,952	+51/+39
23	70	29	47	X-3HSER24723048	6,027	+51/+46
23	70	29	53	X-3HSER24723054	6,149	+51/+50
23	70	29	59	X-3HSER24723060	6,181	+51/+50
23	70	29	65	X-3HSER24723066	6,295	+51/+56
23	70	29	71	X-3HSER24723072	6,389	+51/+61
23	76	29	41	X-3HSER24783042	6,030	+54/+39
23	76	29	47	X-3HSER24783048	6,106	+54/+46
23	76	29	53	X-3HSER24783054	6,227	+54/+50
23	76	29	59	X-3HSER24783060	6,259	+54/+50
23	76	29	65	X-3HSER24783066	6,372	+54/+56
23	76	29	71	X-3HSER24783072	6,466	+54/+61
23	82	29	41	X-3HSER24843042	6,111	+58/+39
23	82	29	47	X-3HSER24843048	6,185	+58/+46
23	82	29	53	X-3HSER24843054	6,307	+58/+50
23	82	29	59	X-3HSER24843060	6,337	+58/+50
23	82	29	65	X-3HSER24843066	6,451	+58/+56
23	82	29	71	X-3HSER24843072	6,546	+58/+61

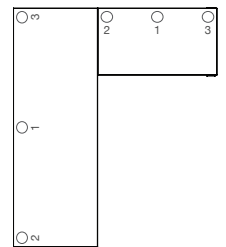
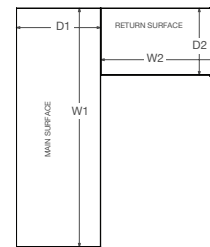
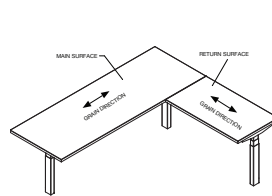
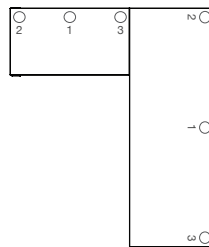
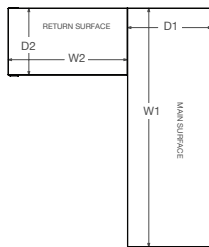
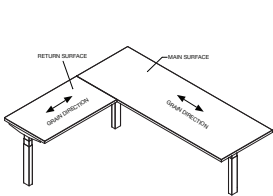

Specify

- Lam. Selection for Main Worksurface
- Lam. Selection for Return Worksurface
- Color Selection for Edge
- Color Selection for Leg - Black, Metallic Silver or White
- Optional Grommet Locations (+38)
- Grommet Cover Color (if applicable)

Notes

- **Must be purchased with Height Adjustable Bases, Height Adjustable Storage Bases or Height Adjustable Base Single Foot Kits or Height Adjustable Table Foot Glides to use.**
- 29" to 46" height adjustable range.
- Supply voltage: 90-127V / 50-60Hz. Nominal voltage: 120V / 60Hz.
- Sizes are nominal and 1" shorter to accommodate pinch points.
- Worksurfaces that are 30" deep and have a width of 60 or wider will come with two u-channels to stiffen the work surface.
- U-channels are 24" shorter than the nominal worksurface width.
- Grommet holes with covers are specified as options.

Calibrate 3-Leg Height Adjustable Tables

**CALIBRATE 3-LEG HEIGHT ADJUSTABLE TABLES
MAIN SURFACE RIGHT, RETURN LEFT, 2MM EDGE**

D ¹ Actual	W ¹ Actual	D ² Actual	W ² Actual	Model Number	List	Grade C Laminate
23	46	23	41	X-3HSEL24482442	5,554	+33/+33
23	46	23	47	X-3HSEL24482448	5,627	+33/+41
23	46	23	53	X-3HSEL24482454	5,747	+33/+41
23	46	23	59	X-3HSEL24482460	5,781	+33/+50
23	46	23	65	X-3HSEL24482466	5,894	+33/+51
23	46	23	71	X-3HSEL24482472	5,989	+33/+54
23	52	23	41	X-3HSEL24542442	5,681	+33/+41
23	52	23	47	X-3HSEL24542448	5,757	+41/+41
23	52	23	53	X-3HSEL24542454	5,878	+41/+41
23	52	23	59	X-3HSEL24542460	5,910	+41/+50
23	52	23	65	X-3HSEL24542466	6,023	+41/+51
23	52	23	71	X-3HSEL24542472	6,118	+41/+54
23	58	23	41	X-3HSEL24602442	5,713	+33/+41
23	58	23	47	X-3HSEL24602448	5,788	+41/+41
23	58	23	53	X-3HSEL24602454	5,910	+41/+41
23	58	23	59	X-3HSEL24602460	5,943	+41/+50
23	58	23	65	X-3HSEL24602466	6,054	+41/+51
23	58	23	71	X-3HSEL24602472	6,150	+41/+54
23	64	23	41	X-3HSEL24662442	5,817	+33/+46
23	64	23	47	X-3HSEL24662448	5,892	+41/+46
23	64	23	53	X-3HSEL24662454	6,013	+41/+46
23	64	23	59	X-3HSEL24662460	6,045	+50/+46
23	64	23	65	X-3HSEL24662466	6,159	+46/+51
23	64	23	71	X-3HSEL24662472	6,254	+46/+54

**CALIBRATE 3-LEG HEIGHT ADJUSTABLE TABLES
MAIN SURFACE LEFT, RETURN RIGHT, 2MM EDGE**

D ¹ Actual	W ¹ Actual	D ² Actual	W ² Actual	Model Number	List	Grade C Laminate
23	46	23	41	X-3HSER24482442	5,554	+33/+33
23	46	23	47	X-3HSER24482448	5,627	+33/+41
23	46	23	53	X-3HSER24482454	5,747	+33/+41
23	46	23	59	X-3HSER24482460	5,781	+33/+50
23	46	23	65	X-3HSER24482466	5,894	+33/+51
23	46	23	71	X-3HSER24482472	5,989	+33/+54
23	52	23	41	X-3HSER24542442	5,681	+33/+41
23	52	23	47	X-3HSER24542448	5,757	+41/+41
23	52	23	53	X-3HSER24542454	5,878	+41/+41
23	52	23	59	X-3HSER24542460	5,910	+41/+50
23	52	23	65	X-3HSER24542466	6,023	+41/+51
23	52	23	71	X-3HSER24542472	6,118	+41/+54
23	58	23	41	X-3HSER24602442	5,713	+33/+41
23	58	23	47	X-3HSER24602448	5,788	+41/+41
23	58	23	53	X-3HSER24602454	5,910	+41/+41
23	58	23	59	X-3HSER24602460	5,943	+41/+50
23	58	23	65	X-3HSER24602466	6,054	+41/+51
23	58	23	71	X-3HSER24602472	6,150	+41/+54
23	64	23	41	X-3HSER24662442	5,817	+33/+46
23	64	23	47	X-3HSER24662448	5,892	+41/+46
23	64	23	53	X-3HSER24662454	6,013	+41/+46
23	64	23	59	X-3HSER24662460	6,045	+50/+46
23	64	23	65	X-3HSER24662466	6,159	+46/+51
23	64	23	71	X-3HSER24662472	6,254	+46/+54

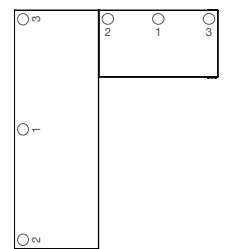
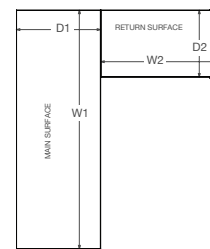
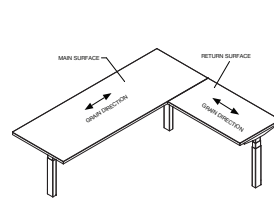
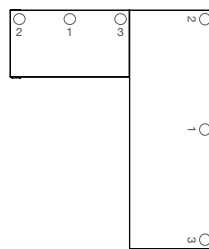
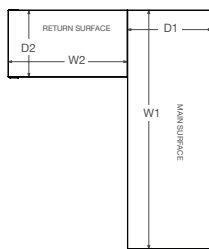
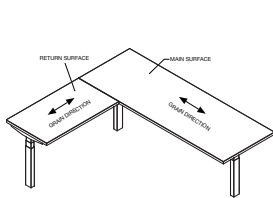

Specify

- Lam. Selection for Main Worksurface
- Lam. Selection for Return Worksurface
- Color Selection for Edge
- Color Selection for Leg - Black, Metallic Silver or White
- Optional Grommet Locations (+38)
- Grommet Cover Color (if applicable)

Notes

- **Must be purchased with Height Adjustable Bases, Height Adjustable Storage Bases or Height Adjustable Base Single Foot Kits or Height Adjustable Table Foot Glides to use.**
- 29" to 46" height adjustable range.
- Supply voltage: 90-127V / 50-60Hz. Nominal voltage: 120V / 60Hz.
- Sizes are nominal and 1" shorter to accommodate pinch points.
- Worksurfaces that are 30" deep and have a width of 60 or wider will come with two u-channels to stiffen the work surface.
- U-channels are 24" shorter than the nominal worksurface width.
- Grommet holes with covers are specified as options.

Calibrate 3-Leg Height Adjustable Tables

**CALIBRATE 3-LEG HEIGHT ADJUSTABLE TABLES
MAIN SURFACE RIGHT, RETURN LEFT, 2MM EDGE**

D ¹ Actual	W ¹ Actual	D ² Actual	W ² Actual	Model Number	List	Grade C Laminate
23	70	23	41	X-3HSEL24722442	5,904	+33/+51
23	70	23	47	X-3HSEL24722448	5,979	+41/+51
23	70	23	53	X-3HSEL24722454	6,101	+41/+51
23	70	23	59	X-3HSEL24722460	6,134	+50/+51
23	70	23	65	X-3HSEL24722466	6,247	+51/+51
23	70	23	71	X-3HSEL24722472	6,341	+51/+54
23	76	23	41	X-3HSEL24782442	5,983	+33/+54
23	76	23	47	X-3HSEL24782448	6,058	+41/+54
23	76	23	53	X-3HSEL24782454	6,179	+41/+54
23	76	23	59	X-3HSEL24782460	6,212	+50/+54
23	76	23	65	X-3HSEL24782466	6,325	+51/+54
23	76	23	71	X-3HSEL24782472	6,418	+54/+54
23	82	23	41	X-3HSEL24842442	6,064	+33/+63
23	82	23	47	X-3HSEL24842448	6,137	+41/+63
23	82	23	53	X-3HSEL24842454	6,259	+41/+63
23	82	23	59	X-3HSEL24842460	6,289	+50/+63
23	82	23	65	X-3HSEL24842466	6,404	+51/+63
23	82	23	71	X-3HSEL24842472	6,499	+54/+63

**CALIBRATE 3-LEG HEIGHT ADJUSTABLE TABLES
MAIN SURFACE LEFT, RETURN RIGHT, 2MM EDGE**

D ¹ Actual	W ¹ Actual	D ² Actual	W ² Actual	Model Number	List	Grade C Laminate
23	70	23	41	X-3HSER24722442	5,904	+33/+51
23	70	23	47	X-3HSER24722448	5,979	+41/+51
23	70	23	53	X-3HSER24722454	6,101	+41/+51
23	70	23	59	X-3HSER24722460	6,134	+50/+51
23	70	23	65	X-3HSER24722466	6,247	+51/+51
23	70	23	71	X-3HSER24722472	6,341	+51/+54
23	76	23	41	X-3HSER24782442	5,983	+33/+54
23	76	23	47	X-3HSER24782448	6,058	+41/+54
23	76	23	53	X-3HSER24782454	6,179	+41/+54
23	76	23	59	X-3HSER24782460	6,212	+50/+54
23	76	23	65	X-3HSER24782466	6,325	+51/+54
23	76	23	71	X-3HSER24782472	6,418	+54/+54
23	82	23	41	X-3HSER24842442	6,064	+33/+63
23	82	23	47	X-3HSER24842448	6,137	+41/+63
23	82	23	53	X-3HSER24842454	6,259	+41/+63
23	82	23	59	X-3HSER24842460	6,289	+50/+63
23	82	23	65	X-3HSER24842466	6,404	+51/+63
23	82	23	71	X-3HSER24842472	6,499	+54/+63

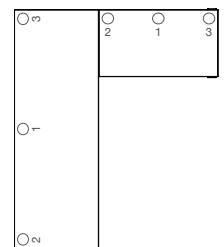
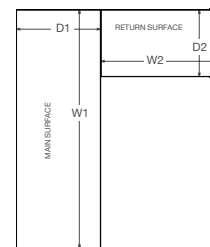
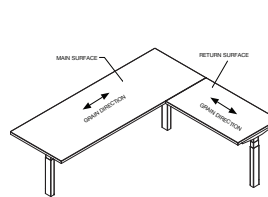
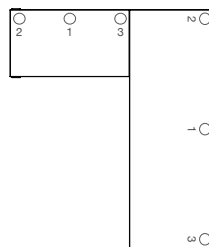
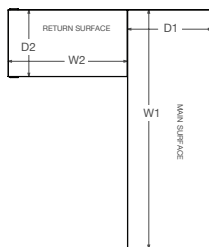
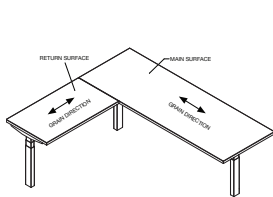

Specify

- Lam. Selection for Main Worksurface
- Lam. Selection for Return Worksurface
- Color Selection for Edge
- Color Selection for Leg - Black, Metallic Silver or White
- Optional Grommet Locations (+38)
- Grommet Cover Color (if applicable)

Notes

- **Must be purchased with Height Adjustable Bases, Height Adjustable Storage Bases or Height Adjustable Base Single Foot Kits or Height Adjustable Table Foot Glides to use.**
- 29" to 46" height adjustable range.
- Supply voltage: 90-127V / 50-60Hz. Nominal voltage: 120V / 60Hz.
- Sizes are nominal and 1" shorter to accommodate pinch points.
- Worksurfaces that are 30" deep and have a width of 60 or wider will come with two u-channels to stiffen the work surface.
- U-channels are 24" shorter than the nominal worksurface width.
- Grommet holes with covers are specified as options.

Foot Kits, End Panels and Modesties for Height Adjustable Tables

CALIBRATE 50MM X 80MM HAT SINGLE FOOT KIT V2

D	Model Number	List
24	T-SFSS-V2	205
30	T-SFSS30-V2	245

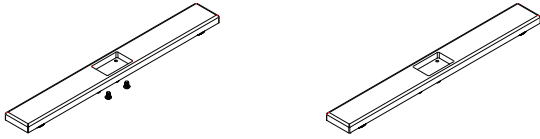

Specify **Notes**

- Paint Selection for Foot

CALIBRATE GLIDE STAND OFF 50MM X80MM - PAINTED

Color	Model Number	List
Black	T-GSO	44

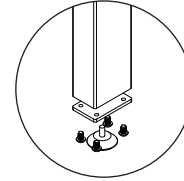

Specify **Notes**

END PANELS FOR DAY-TO-DAY TABLES WITH HEIGHT ADJUSTABLE BASES

D	H	Model Number	List	Grade C Laminate
24	29	T-EPHAT2924	625	+60
24	42	T-EPHAT4224	687	+66
24	46	T-EPHAT4624	706	+74
24	50	T-EPHAT5024	727	+76
30	29	T-EPHAT2930	813	+64
30	42	T-EPHAT4230	875	+68
30	46	T-EPHAT4630	896	+86
30	50	T-EPHAT5030	916	+84

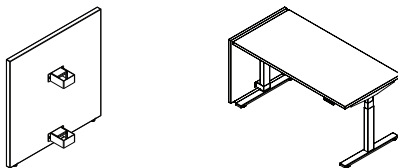

Specify **Notes**

- Laminate Selection
 - Color Selection for Edge
 - Paint Selection for Bracket
- End panel depths match the actual depth of AIS Benching Height Adjustable Tables, and may be installed to either side of the table.
- End Panels are sold individually, to install on both sides of a table, two must be ordered.
- Includes glides.

SUSPENDED HEIGHT ADJUSTABLE MODESTY

H	Nominal Width	Actual Width	Model Number	List
12	42	26	X-HATM1242	737
12	48	32	X-HATM1248	747
12	54	38	X-HATM1254	759
12	60	44	X-HATM1260	768
12	66	50	X-HATM1266	779
12	72	56	X-HATM1272	789
12	78	62	X-HATM1278	801
12	84	68	X-HATM1284	909
12	90	74	X-HATM1290	921
12	96	80	X-HATM1296	931

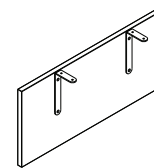

Specify **Notes**

- Laminate Selection
- This optional modesty panel can be specified on the height adjustable table desk.
- Select sizes available on quick ship Calibrate Countdown program. See [Calibrate Countdown price list](#) for full details.

Calibrate Combo Unit w/Integrated Calibrate Height Adjustable Table

COMBO UNIT W/INTEGRATED CALIBRATE HEIGHT ADJUSTABLE TABLE; 24"W BOOKCASE – LEFT

D	W	H	Model Number	List
18	54	21	X-HCL21541824	3,860
18	60	21	X-HCL21601824	4,031
18	66	21	X-HCL21661824	4,201
24	54	21	X-HCL21542424	4,031
24	60	21	X-HCL21602424	4,201
24	66	21	X-HCL21662424	4,371

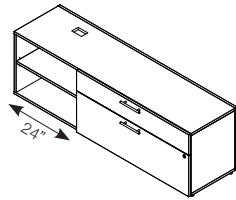

66" Wide x 24" Deep (Left)

COMBO UNIT W/INTEGRATED CALIBRATE HEIGHT ADJUSTABLE TABLE; 24"W BOOKCASE – RIGHT

D	W	H	Model Number	List
18	54	21	X-HCR21541824	3,860
18	60	21	X-HCR21601824	4,031
18	66	21	X-HCR21661824	4,201
24	54	21	X-HCR21542424	4,031
24	60	21	X-HCR21602424	4,201
24	66	21	X-HCR21662424	4,371

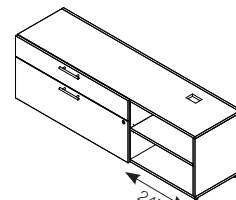

66" Wide x 24" Deep (Right)

Specify **Notes**

- Laminate Selection for Case
 - Laminate Selection for Face/Drawer
 - Handle Selection
- Used with Calibrate Height Adjustable Tables only.
 - Unit includes silver trim ring for leg cutout.

COMBO UNIT W/INTEGRATED CALIBRATE HEIGHT ADJUSTABLE TABLE; 30"W BOOKCASE – LEFT

D	W	H	Model Number	List
18	60	21	X-HCL21601830	4,031
18	66	21	X-HCL21661830	4,201
18	72	21	X-HCL21721830	4,371
24	60	21	X-HCL21602430	4,201
24	66	21	X-HCL21662430	4,371
24	72	21	X-HCL21722430	4,542

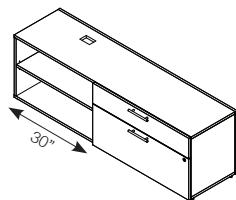

66" Wide x 24" Deep (Left)

COMBO UNIT W/INTEGRATED CALIBRATE HEIGHT ADJUSTABLE TABLE; 30"W BOOKCASE – RIGHT

D	W	H	Model Number	List
18	60	21	X-HCR21601830	4,031
18	66	21	X-HCR21661830	4,201
18	72	21	X-HCR21721830	4,371
24	60	21	X-HCR21602430	4,201
24	66	21	X-HCR21662430	4,371
24	72	21	X-HCR21722430	4,542

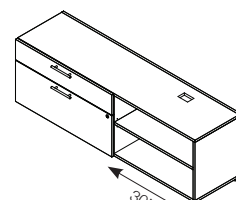

66" Wide x 24" Deep (Right)

Specify **Notes**

- Laminate Selection for Case
 - Laminate Selection for Face/Drawer
 - Handle Selection
- Used with Calibrate Height Adjustable Tables only.
 - Unit includes silver trim ring for leg cutout.

LB Lounge Corner and End Tables, Volker Cube Nesting Table

LB LOUNGE CORNER TABLE						
			Powered		Non-Powered	
H	W	D	Model Number	List	Model Number	List
18	30	30	F-CCT203030P	2,796	F-CCT203030	1,593

LB LOUNGE END TABLE						
			Powered		Non-Powered	
H	W	D	Model Number	List	Model Number	List
18	24	30	F-CET202430P	2,766	F-CET202430	1,569

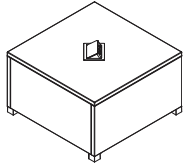

Powered

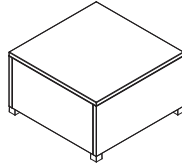

Non-Powered

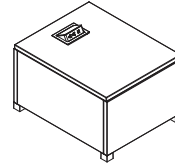

Powered

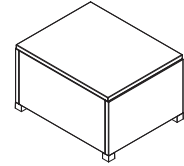

Non-Powered

Specify

Notes

- Laminate Selection for Table
- Color Selection for Power Unit (White/White or White/Silver)
- See below for example configuration.
- LB Lounge Seating sold separately. See Seating Price List for LB Lounge pricing and options.
- Powered tables feature an Ashley Duo Air power unit with two outlets and two USB ports.

VOLKER CUBE NESTING TABLE				
H	W	D	Model Number	List
19.25	37 3/8	37 3/8	F-CNTABLE	1,344

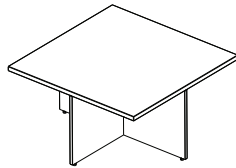

Specify

Notes

- Laminate Selection for Base and Top
- Edgeband Selection for Top
- See below for example configuration.
- Volker Cubes sold separately. See Seating Price List for Volker Cube pricing and options.

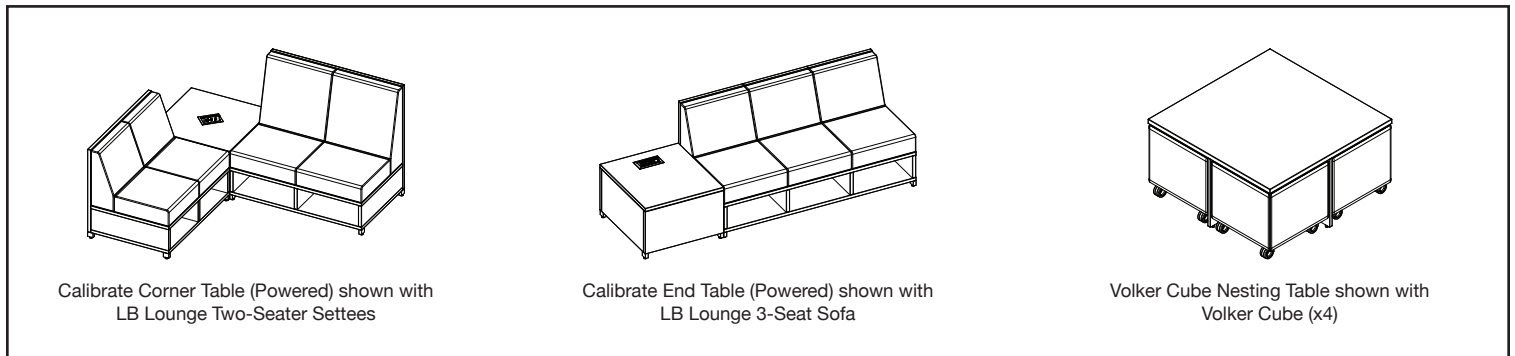

Calibrate Corner Table (Powered) shown with LB Lounge Two-Seater Settees

Calibrate End Table (Powered) shown with LB Lounge 3-Seat Sofa

Volker Cube Nesting Table shown with Volker Cube (x4)

Open Wall Mounted Storage

16" HIGH WALL MOUNTED OPEN OVERHEAD

H	W	D	Model Number	List
16	36	14	C-OWM163614	1,430
16	42	14	C-OWM164214	1,465
16	48	14	C-OWM164814	1,508
16	54	14	C-OWM165414	1,726
16	60	14	C-OWM166014	1,762
16	66	14	C-OWM166614	1,804
16	72	14	C-OWM167214	1,839
16	78	14	C-OWM167814	1,844
16	84	14	C-OWM168414	1,879
16	90	14	C-OWM169014	1,912
16	96	14	C-OWM169614	1,946

DOUBLE HEIGHT WALL MOUNTED OPEN OVERHEAD

H	W	D	Model Number	List
32	36	14	X-ODWM323614	1,929
32	42	14	X-ODWM324214	2,008
32	48	14	X-ODWM324814	2,113
32	54	14	X-ODWM325414	2,367
32	60	14	X-ODWM326014	2,424
32	66	14	X-ODWM326614	2,488
32	72	14	X-ODWM327214	2,548
32	78	14	X-ODWM327814	2,603
32	84	14	X-ODWM328414	2,663
32	90	14	X-ODWM329014	2,720
32	96	14	X-ODWM329614	2,778

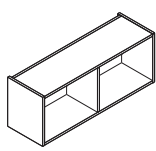

36" - 48" Wide

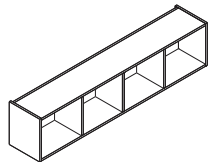

54" - 96" Wide

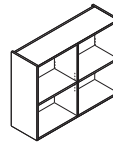

36" - 48" Wide

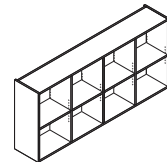

54" - 96" Wide

8" HIGH WALL MOUNTED OPEN OVERHEAD

H	W	D	Model Number	List
8	36	14	C-OWM083614	1,703
8	42	14	C-OWM084214	1,732
8	48	14	C-OWM084814	1,766
8	54	14	C-OWM085414	1,826
8	60	14	C-OWM086014	1,854
8	66	14	C-OWM086614	1,889
8	72	14	C-OWM087214	1,917
8	78	14	C-OWM087814	1,947
8	84	14	C-OWM088414	1,982
8	90	14	C-OWM089014	2,008
8	96	14	C-OWM089614	2,036

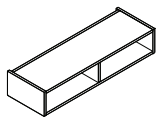

36" - 48" Wide

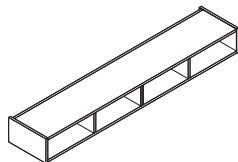

54" - 96" Wide

Specify

• Laminate Selection for Unit

Notes

• Select sizes available on quick ship Calibrate Countdown program. See [Calibrate Countdown price list](#) for full details.

Wall Mounted Storage with Cabinet Doors

WALL MOUNTED OVERHEAD WITH CABINET DOORS

H	W	D	Model Number	List
16	36	14	C-OWMC163614L	1,905
16	42	14	C-OWMC164214L	1,944
16	48	14	C-OWMC164814L	1,990
16	54	14	C-OWMC165414L	2,372
16	60	14	C-OWMC166014L	2,413
16	66	14	C-OWMC166614L	2,464
16	72	14	C-OWMC167214L	2,504
16	78	14	C-OWMC167814L	2,537
16	84	14	C-OWMC168414L	2,547
16	90	14	C-OWMC169014L	2,581
16	96	14	C-OWMC169614L	2,614

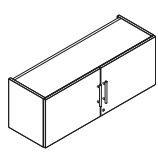

36" - 48" Wide

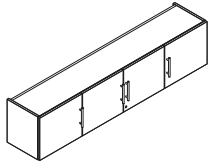

54" - 78" Wide

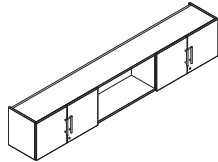

84" - 96" Wide

WALL MOUNTED OVERHEAD WITH FRAMED CABINET DOORS

H	W	D	Model Number	List
16	36	14	C-OWMC163614LG	3,042
16	42	14	C-OWMC164214LG	3,224
16	48	14	C-OWMC164814LG	3,414
16	54	14	C-OWMC165414LG	4,027
16	60	14	C-OWMC166014LG	4,212
16	66	14	C-OWMC166614LG	4,401
16	72	14	C-OWMC167214LG	4,585
16	78	14	C-OWMC167814LG	4,760
16	84	14	C-OWMC168414LG	4,408
16	90	14	C-OWMC169014LG	4,549
16	96	14	C-OWMC169614LG	4,690

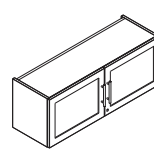

36" - 48" Wide

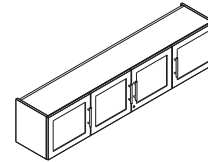

54" - 78" Wide

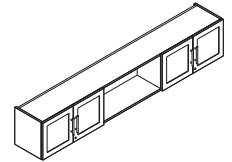

84" - 96" Wide

DOUBLE HEIGHT WALL MOUNTED OVERHEAD WITH CABINET DOORS

H	W	D	Model Number	List
32	36	14	X-CDWM323614	2,198
32	42	14	X-CDWM324214	2,283
32	48	14	X-CDWM324814	2,367
32	54	14	X-CDWM325414	2,882
32	60	14	X-CDWM326014	2,965
32	66	14	X-CDWM326614	3,058
32	72	14	X-CDWM327214	3,143
32	78	14	X-CDWM327814	3,226

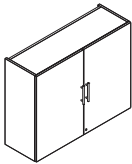

36" - 48" Wide

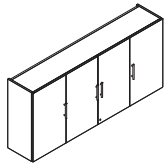

54" - 78" Wide

DOUBLE HEIGHT WALL MOUNTED OVERHEAD WITH FRAMED CABINET DOORS

H	W	D	Model Number	List
32	36	14	X-GCDWM323614	4,130
32	42	14	X-GCDWM324214	4,467
32	48	14	X-GCDWM324814	4,956
32	54	14	X-GCDWM325414	5,728
32	60	14	X-GCDWM326014	6,066
32	66	14	X-GCDWM326614	6,411
32	72	14	X-GCDWM327214	6,748
32	78	14	X-GCDWM327814	7,087

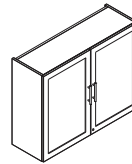

36" - 48" Wide

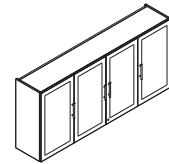

54" - 78" Wide

Specify

- Laminate Selection for Case
- Laminate Selection for Door/Face
- Handle Choice

Notes

- Framed doors are silver vinyl wrapped with frosted glass.
- Select sizes available on quick ship Calibrate Countdown program. See [Calibrate Countdown price list](#) for full details.

Wall Mounted Storage with Sliding Doors

WALL MOUNTED OVERHEAD WITH SLIDING DOORS

H	W	D	Left-Side Lock	Right-Side Lock	List
			Model Number	Model Number	
16	36	14	C-OWMS163614LL	C-OWMS163614RL	2,059
16	42	14	C-OWMS164214LL	C-OWMS164214RL	2,100
16	48	14	C-OWMS164814LL	C-OWMS164814RL	2,149
16	54	14	C-OWMS165414LL	C-OWMS165414RL	2,373
16	60	14	C-OWMS166014LL	C-OWMS166014RL	2,419
16	66	14	C-OWMS166614LL	C-OWMS166614RL	2,469
16	72	14	C-OWMS167214LL	C-OWMS167214RL	2,510
16	78	14	C-OWMS167814LL	C-OWMS167814RL	2,554
16	84	14	C-OWMS168414RL		2,854
16	90	14	C-OWMS169014RL		2,864
16	96	14	C-OWMS169614RL		2,906

WALL MOUNTED OVERHEAD WITH FRAMED SLIDING DOORS

H	W	D	Left-Side Lock	Right Handed	List
			Model Number	Model Number	
16	36	14	X-SFLWM163614L	X-SFLWM163614R	2,756
16	42	14	X-SFLWM164214L	X-SFLWM164214R	2,865
16	48	14	X-SFLWM164814L	X-SFLWM164814R	2,983
16	54	14	X-SFLWM165414L	X-SFLWM165414R	3,275
16	60	14	X-SFLWM166014L	X-SFLWM166014R	3,384
16	66	14	X-SFLWM166614L	X-SFLWM166614R	3,499
16	72	14	X-SFLWM167214L	X-SFLWM167214R	3,609
16	78	14	X-SFLWM167814L	X-SFLWM167814R	3,719
16	84	14	X-SFLWM168414		4,439
16	90	14	X-SFLWM169014		4,535
16	96	14	X-SFLWM169614		4,669

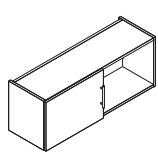

36" - 48" Wide
(Left-Side Lock)

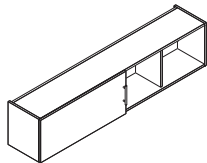

54" - 78" Wide
(Left-Side Lock)

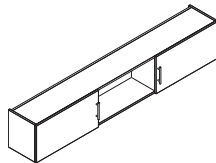

84" - 96" Wide
(Non-Handed)

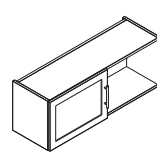

36" - 48" Wide
(Left-Side Lock)

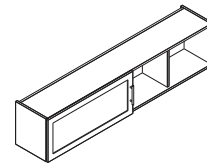

54" - 78" Wide
(Left-Side Lock)

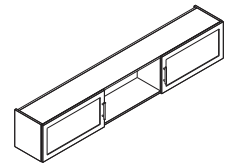

84" - 96" Wide
(Non-Handed)

DOUBLE HEIGHT WALL MOUNTED OVERHEAD WITH SLIDING DOORS

H	W	D	Left-Side Lock	Right-Side Lock	List
			Model Number	Model Number	
32	36	14	X-SDLWM323614	X-SDRWM323614	2,557
32	42	14	X-SDLWM324214	X-SDRWM324214	2,627
32	48	14	X-SDLWM324814	X-SDRWM324814	2,705
32	54	14	X-SDLWM325414	X-SDRWM325414	3,015
32	60	14	X-SDLWM326014	X-SDRWM326014	3,086
32	66	14	X-SDLWM326614	X-SDRWM326614	3,163
32	72	14	X-SDLWM327214	X-SDRWM327214	3,236
32	78	14	X-SDLWM327814	X-SDRWM327814	3,304

DOUBLE HEIGHT WALL MOUNTED OVERHEAD WITH FRAMED SLIDING DOORS

H	W	D	Left-Side Lock	Right-Side Lock	List
			Model Number	Model Number	
32	36	14	X-SGDLWM323614	X-SGDRWM323614	3,394
32	42	14	X-SGDLWM324214	X-SGDRWM324214	3,589
32	48	14	X-SGDLWM324814	X-SGDRWM324814	3,797
32	54	14	X-SGDLWM325414	X-SGDRWM325414	4,197
32	60	14	X-SGDLWM326014	X-SGDRWM326014	4,392
32	66	14	X-SGDLWM326614	X-SGDRWM326614	4,593
32	72	14	X-SGDLWM327214	X-SGDRWM327214	4,785
32	78	14	X-SGDLWM327814	X-SGDRWM327814	4,978

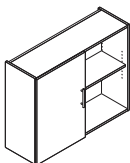

36" - 48" Wide
(Left-Side Lock)

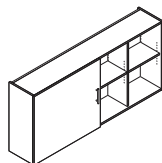

54" - 78" Wide
(Left-Side Lock)

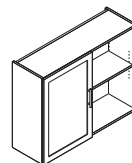

36" - 48" Wide
(Left-Side Lock)

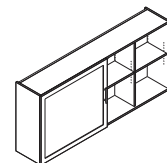

54" - 78" Wide
(Left-Side Lock)

Specify

- Laminate Selection for Case
- Laminate Selection for Door/Face
- Handle Choice

Notes

- Framed doors are silver vinyl wrapped with frosted glass. Left-side lock overheads shown.

Wall Mounted L Shelves

WALL MOUNTED L SHELVES					
H	W	D	Shelves	Model Number	List
16	24	12	1	X-LSWM162412	772
16	30	12	1	X-LSWM163012	791
16	36	12	1	X-LSWM163612	810
16	42	12	1	X-LSWM164212	830
16	48	12	1	X-LSWM164812	849
16	54	12	1	X-LSWM165412	869
16	60	12	1	X-LSWM166012	888
16	66	12	1	X-LSWM166612	908
16	72	12	1	X-LSWM167212	927
20	24	12	1	X-LSWM202412	826
20	30	12	1	X-LSWM203012	846
20	36	12	1	X-LSWM203612	867
20	42	12	1	X-LSWM204212	888
20	48	12	1	X-LSWM204812	909
20	54	12	1	X-LSWM205412	930
20	60	12	1	X-LSWM206012	950
20	66	12	1	X-LSWM206612	971
20	72	12	1	X-LSWM207212	992
28	24	12	1	X-LSWM282412	883
28	30	12	1	X-LSWM283012	906
28	36	12	1	X-LSWM283612	928
28	42	12	1	X-LSWM284212	950
28	48	12	1	X-LSWM284812	972
28	54	12	1	X-LSWM285412	995
28	60	12	1	X-LSWM286012	1,017
28	66	12	1	X-LSWM286612	1,039
28	72	12	1	X-LSWM287212	1,061

WALL MOUNTED L SHELVES					
H	W	D	Shelves	Model Number	List
32	24	12	2	X-LSWM322412	963
32	30	12	2	X-LSWM323012	987
32	36	12	2	X-LSWM323612	1,011
32	42	12	2	X-LSWM324212	1,036
32	48	12	2	X-LSWM324812	1,060
32	54	12	2	X-LSWM325412	1,084
32	60	12	2	X-LSWM326012	1,108
32	66	12	2	X-LSWM326612	1,133
32	72	12	2	X-LSWM327212	1,157
36	24	12	1	X-LSWM362412	1,030
36	30	12	1	X-LSWM363012	1,056
36	36	12	1	X-LSWM363612	1,082
36	42	12	1	X-LSWM364212	1,108
36	48	12	1	X-LSWM364812	1,134
36	54	12	1	X-LSWM365412	1,160
36	60	12	1	X-LSWM366012	1,186
36	66	12	1	X-LSWM366612	1,212
36	72	12	1	X-LSWM367212	1,238
45	24	12	2	X-LSWM452412	1,102
45	30	12	2	X-LSWM453012	1,130
45	36	12	2	X-LSWM453612	1,158
45	42	12	2	X-LSWM454212	1,186
45	48	12	2	X-LSWM454812	1,213
45	54	12	2	X-LSWM455412	1,241
45	60	12	2	X-LSWM456012	1,269
45	66	12	2	X-LSWM456612	1,297
45	72	12	2	X-LSWM457212	1,324

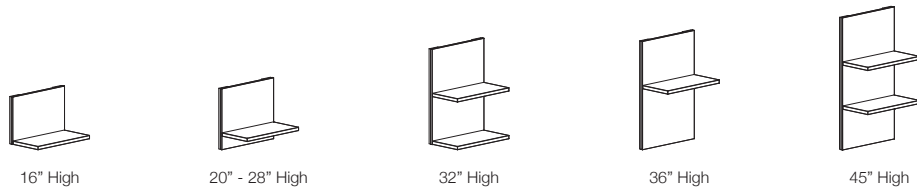

Specify

- Laminate Selection for Backboard
- Laminate Selection for Shelf

Notes

- Shelves have a max capacity of 10lbs per foot per width.
- Total thickness is 1 1/2". Backboard is mounted on 3/4" thick board finished in matching edge.
- Laminate grain for shelf always runs horizontal. Laminate grain for backboard on 24 - 60 wide units runs vertical and 66 - 72 wide units run horizontal.
- L Shelves are shipped assembled.

WALL MOUNTED L SHELVES

H	W	D	Shelves	Model Number	List
52	24	12	2	X-LSWM522412	1,179
52	30	12	2	X-LSWM523012	1,209
52	36	12	2	X-LSWM523612	1,239
52	42	12	2	X-LSWM524212	1,269
52	48	12	2	X-LSWM524812	1,298
52	54	12	2	X-LSWM525412	1,328
52	60	12	2	X-LSWM526012	1,358
52	66	12	2	X-LSWM526612	1,387
52	72	12	2	X-LSWM527212	1,417
60	24	12	2	X-LSWM602412	1,262
60	30	12	3	X-LSWM603012	1,294
60	36	12	3	X-LSWM603612	1,325
60	42	12	3	X-LSWM604212	1,357
60	48	12	3	X-LSWM604812	1,389
60	54	12	3	X-LSWM605412	1,421
60	60	12	3	X-LSWM606012	1,453

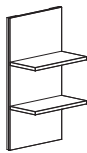

52" High



60" High

Specify

Notes

- Laminate Selection for Backboard
- Laminate Selection for Shelf

- Shelves have a max capacity of 10lbs per foot per width.
- Total thickness is 1 1/2". Backboard is mounted on 3/4" thick board finished in matching edge.
- Laminate grain for shelf always runs horizontal. Laminate grain for backboard on 24 - 60 wide units runs vertical and 66 - 72 wide units run horizontal.
- L Shelves are shipped assembled.

Wall Panels

WALL PANELS				WALL PANELS			
H	W	Model Number	List	H	W	Model Number	List
16	24	X-WP1624	643	32	24	X-WP3224	803
16	30	X-WP1630	659	32	30	X-WP3230	822
16	36	X-WP1636	675	32	36	X-WP3236	843
16	42	X-WP1642	692	32	42	X-WP3242	863
16	48	X-WP1648	708	32	48	X-WP3248	883
16	54	X-WP1654	724	32	54	X-WP3254	903
16	60	X-WP1660	740	32	60	X-WP3260	924
16	66	X-WP1666	756	32	66	X-WP3266	944
16	72	X-WP1672	773	32	72	X-WP3272	964
20	24	X-WP2024	688	36	24	X-WP3624	859
20	30	X-WP2030	706	36	30	X-WP3630	881
20	36	X-WP2036	723	36	36	X-WP3636	902
20	42	X-WP2042	740	36	42	X-WP3642	924
20	48	X-WP2048	758	36	48	X-WP3648	945
20	54	X-WP2054	775	36	54	X-WP3654	967
20	60	X-WP2060	792	36	60	X-WP3660	989
20	66	X-WP2066	809	36	66	X-WP3666	1,010
20	72	X-WP2072	827	36	72	X-WP3672	1,032
28	24	X-WP2824	736	45	24	X-WP4524	918
28	30	X-WP2830	754	45	30	X-WP4530	942
28	36	X-WP2836	774	45	36	X-WP4536	965
28	42	X-WP2842	792	45	42	X-WP4542	988
28	48	X-WP2848	810	45	48	X-WP4548	1,011
28	54	X-WP2854	829	45	54	X-WP4554	1,034
28	60	X-WP2860	847	45	60	X-WP4560	1,058
28	66	X-WP2866	866	45	66	X-WP4566	1,080
28	72	X-WP2872	885	45	72	X-WP4572	1,104

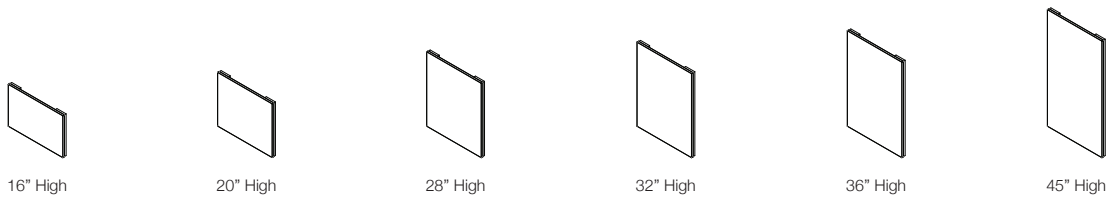

Specify

- Laminate Selection

Notes

- Wall Panel is made from 3/4" thick laminate.
- Laminate grain for Wall Panel on 24 - 60 wide units runs vertical and 66 - 72 wide units run horizontal.
- Total thickness is 1 1/2". Wall Panel is mounted on 3/4" thick board finished in matching edge.

WALL PANELS			
H	W	Model Number	List
52	24	X-WP5224	983
52	30	X-WP5230	1,008
52	36	X-WP5236	1,032
52	42	X-WP5242	1,057
52	48	X-WP5248	1,082
52	54	X-WP5254	1,106
52	60	X-WP5260	1,131
52	66	X-WP5266	1,156
52	72	X-WP5272	1,181
60	24	X-WP6024	1,051
60	30	X-WP6030	1,078
60	36	X-WP6036	1,104
60	42	X-WP6042	1,131
60	48	X-WP6048	1,157
60	54	X-WP6054	1,184
60	60	X-WP6060	1,211

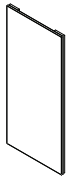

52" High



60" High

Specify	Notes
• Laminate Selection	<ul style="list-style-type: none"> • Wall Panel is made from 3/4" thick laminate. • Laminate grain for Wall Panel on 24 - 60 wide units runs vertical and 66 - 72 wide units run horizontal. • Total thickness is 1 1/2". Wall Panel is mounted on 3/4" thick board finished in matching edge.

Whiteboard Wall Panels

WHITEBOARD WALL PANELS				WHITEBOARD WALL PANELS			
H	W	Model Number	List	H	W	Model Number	List
16	24	X-WP1624WB	656	32	24	X-WP3224WB	818
16	30	X-WP1630WB	672	32	30	X-WP3230WB	839
16	36	X-WP1636WB	690	32	36	X-WP3236WB	860
16	42	X-WP1642WB	706	32	42	X-WP3242WB	881
16	48	X-WP1648WB	722	32	48	X-WP3248WB	901
16	54	X-WP1654WB	738	32	54	X-WP3254WB	922
16	60	X-WP1660WB	755	32	60	X-WP3260WB	942
16	66	X-WP1666WB	772	32	66	X-WP3266WB	963
16	72	X-WP1672WB	788	32	72	X-WP3272WB	983
20	24	X-WP2024WB	701	36	24	X-WP3624WB	875
20	30	X-WP2030WB	720	36	30	X-WP3630WB	898
20	36	X-WP2036WB	737	36	36	X-WP3636WB	920
20	42	X-WP2042WB	754	36	42	X-WP3642WB	942
20	48	X-WP2048WB	773	36	48	X-WP3648WB	964
20	54	X-WP2054WB	790	36	54	X-WP3654WB	987
20	60	X-WP2060WB	808	36	60	X-WP3660WB	1,008
20	66	X-WP2066WB	826	36	66	X-WP3666WB	1,030
20	72	X-WP2072WB	843	36	72	X-WP3672WB	1,052
28	24	X-WP2824WB	751	45	24	X-WP4524WB	937
28	30	X-WP2830WB	769	45	30	X-WP4530WB	961
28	36	X-WP2836WB	789	45	36	X-WP4536WB	984
28	42	X-WP2842WB	807	45	42	X-WP4542WB	1,008
28	48	X-WP2848WB	827	45	48	X-WP4548WB	1,032
28	54	X-WP2854WB	845	45	54	X-WP4554WB	1,055
28	60	X-WP2860WB	864	45	60	X-WP4560WB	1,078
28	66	X-WP2866WB	883	45	66	X-WP4566WB	1,102
28	72	X-WP2872WB	902	45	72	X-WP4572WB	1,126

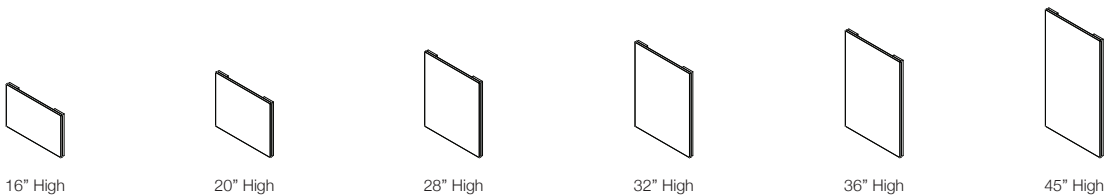

Specify

Notes

- Whiteboard is made from 3/4" thick laminate.
- Total thickness is 1 1/2". Whiteboard is mounted on 3/4" thick board finished in matching edge.
- Whiteboards are non magnetic.

WHITEBOARD WALL PANELS

H	W	Model Number	List
52	24	X-WP5224WB	1,003
52	30	X-WP5230WB	1,028
52	36	X-WP5236WB	1,053
52	42	X-WP5242WB	1,078
52	48	X-WP5248WB	1,103
52	54	X-WP5254WB	1,129
52	60	X-WP5260WB	1,154
52	66	X-WP5266WB	1,186
52	72	X-WP5272WB	1,205
60	24	X-WP6024WB	1,073
60	30	X-WP6030WB	1,100
60	36	X-WP6036WB	1,127
60	42	X-WP6042WB	1,154
60	48	X-WP6048WB	1,181
60	54	X-WP6054WB	1,208

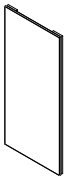

52" High

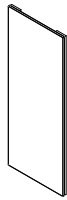

60" High

Specify

Notes

- Whiteboard is made from 3/4" thick laminate.
- Total thickness is 1 1/2". Whiteboard is mounted on 3/4" thick board finished in matching edge.
- Whiteboards are non magnetic.

Suspended Utility Storage and Accessories

SUSPENDED UTILITY STORAGE

H	W	D	Condition	Powered		Non-Powered	
				Model Number	List	Model Number	List
18	12	18	A	X-SUPCA	1,738	X-SUNPCA	1,281
18	12	18	B	X-SUPCB	1,738	X-SUNPCB	1,281
18	12	18	C	X-SUPCC	1,805	X-SUNPCC	1,348

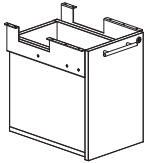

Condition A

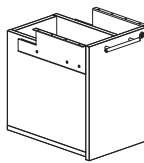

Condition B

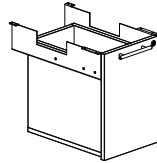

Condition C

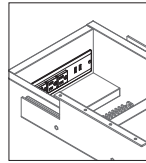

Power Detail

Specify

- Laminate Selection for Drawer Face and Case
- Handle Selection

Notes

- Units have interior dimensions of 8.856"W x 14.917H x 16.480"D.
- Storage unit pulls out a distance of 13.25".
- Powered units included 3 outlets and 2 USB charging ports.
- Can not be used on Calibrate Height Adjustable Tables.
- Digital locks can not be used on suspended storage.

SUSPENDED UTILITY STORAGE CONDITIONS

Condition	For Use With
Condition A	E-Series Height Adjustable Tables, 24" Deep Day-to-Day Height Adjustable Tables, 24" Deep Aloft, 2018 & prior models, 24" Deep Oxygen Worksurfaces, 30" Deep
Condition B	E-Series Height Adjustable Tables, 30" Deep Day-to-Day Height Adjustable Tables, 30" Deep Aloft, all models, 30" Deep Oxygen Worksurfaces, 24" Deep
Condition C	Aloft, 2019+ models, 24" Deep

SUSPENDED UTILITY PENCIL TRAY

Model Number	List
X-PTC	58

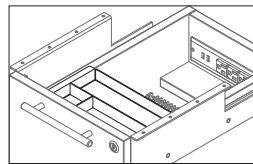
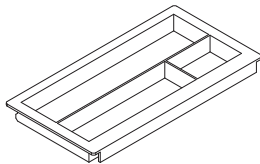

Pencil Tray Detail

Specify

- Paint Selection for Unit

Notes

- Unit has dimension of 5" x 8.75".

SUSPENDED UNIT FOR HANGING FOLDERS KIT

Model Number	List
C-SUPFB	134

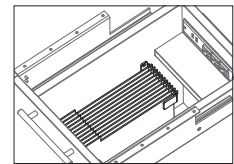
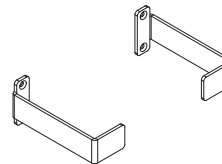

Shown with Folders

Specify

- Paint Selection for Unit

Notes

- Hanging folder kit comes in pairs.
- Kit allows for 3.75" of storage room for folders.

18" High Mobile Pedestals

FILE PEDESTAL ON CASTERS

H	W	D	No Cushion		With Cushion	
			Model Number	List	Model Number	List
18	12	18	C-PCFOCN121818	1,408	C-PCFOCC121818	1,582
18	16	18	C-PCFOCN161818	1,563	C-PCFOCC161818	1,757
18	18	18	C-PCFOCN181818	1,720	C-PCFOCC181818	1,933



No Cushion



With Cushion

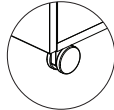

Product is elevated on 2 5/8" casters.

BOX / HIDDEN DRAWER PEDESTAL ON CASTERS

H	W	D	No Cushion		With Cushion	
			Model Number	List	Model Number	List
18	12	18	C-PCFHCN121818	1,725	C-PCFHCC121818	1,940
18	16	18	C-PCFHCN161818	1,916	C-PCFHCC161818	2,154
18	18	18	C-PCFHCN181818	2,109	C-PCFHCC181818	2,369



No Cushion



With Cushion

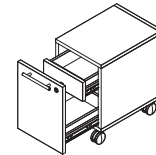

Hidden Drawer Detail

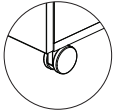

Product is elevated on 2 5/8" casters.

BOTTOM CUBBY BOX PEDESTALS ON CASTERS

H	W	D	No Cushion		With Cushion	
			Model Number	List	Model Number	List
18	12	18	C-PCFLCN121818	1,539	C-PCFLCC121818	1,728
18	16	18	C-PCFLCN161818	1,708	C-PCFLCC161818	1,920
18	18	18	C-PCFLCN181818	1,880	C-PCFLCC181818	2,111



No Cushion



With Cushion

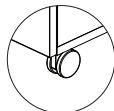

Product is elevated on 2 5/8" casters.

Specify

Notes

- Laminate Selection for Case
- Laminate Selection for Face/Drawer
- Handle Selection

- Heights shown without cushion. Units with cushion measure 20" high.
- Apply the following upcharges for cushion fabric: C.O.M (-50), Grade B (+51), Grade C (+102), Grade D (+152), Grade E (+203)
- C.O.M requires one yard of fabric for first cushion and half a yard for each additional cushion.

21" High BF Pedestals

BF PEDESTALS

H	W	D	Depth	Counterweight	Model Number	List
21	12	18	Full	Y	X-BFPFS182112	1,766
21	12	23	Partial	N	X-BFPFS232112	1,806
21	12	24	Full	Y	X-BFPFS242112	1,892
21	16	18	Full	Y	X-BFP18	1,962
21	16	23	Partial	N	X-BFP22C	2,008
21	16	24	Full	Y	X-BFP24	2,100
21	18	18	Full	Y	X-BFPFS182118	2,085
21	18	23	Partial	N	X-BFPFS232118	2,133
21	18	24	Full	Y	X-BFPFS242118	2,232
21	24	18	Full	Y	X-BFPFS182124	2,292
21	24	23	Partial	N	X-BFPFS232124	2,346
21	24	24	Full	Y	X-BFPFS242124	2,456

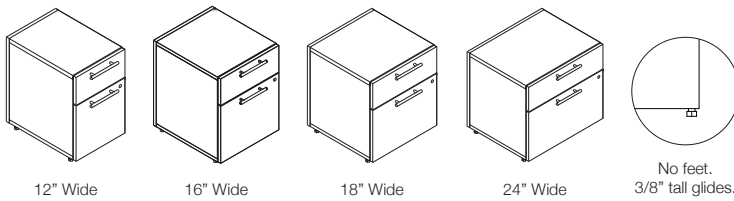

BF PEDESTALS ON FEET

H	W	D	Depth	Counterweight	Model Number	List
21	12	18	Full	Y	C-BFPFS182112	1,831
21	12	23	Partial	N	C-BFPFS232112	1,871
21	12	24	Full	Y	C-BFPFS242112	1,953
21	16	18	Full	Y	C-BFP18	2,031
21	16	23	Partial	N	C-BFP22	2,076
21	16	24	Full	Y	C-BFP24	2,170
21	18	18	Full	Y	C-BFPFS182118	2,159
21	18	23	Partial	N	C-BFPFS232118	2,208
21	18	24	Full	Y	C-BFPFS242118	2,307
21	24	18	Full	Y	C-BFPFS182124	2,373
21	24	23	Partial	N	C-BFPFS232124	2,428
21	24	24	Full	Y	C-BFPFS242124	2,537

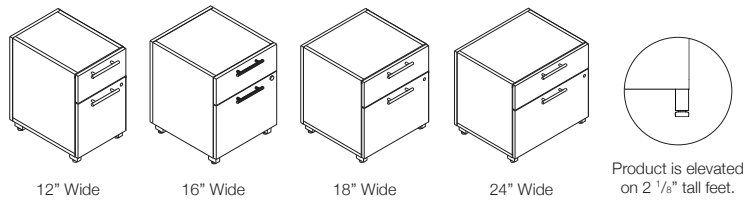

BF PEDESTALS ON CASTERS

H	W	D	No Cushion		With Cushion	
			Model Number	List	Model Number	List
21	12	18	C-BFP1812MNC	1,875	C-BFP1812M	2,108
21	16	18	C-BFP18MNC	2,084	C-BFP18M	2,340
21	18	18	C-BFP1818MNC	2,291	C-BFP1818M	2,574

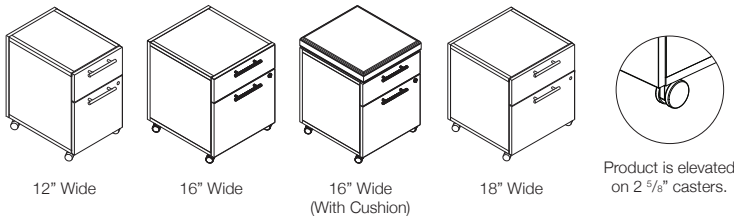

Specify

- Laminate Selection for Case
- Laminate Selection for Face/Drawer
- Handle Selection

Notes

- Model numbers ending in "M" are on casters with pedestal cushion. Model numbers ending in "MNC" are on casters and have no pedestal cushion.
- Heights shown without cushions. 21" high pedestals on casters have an actual height of 22 5/8" without a cushion or 24 1/8" with a cushion.
- See Product Details for more information on how to specify Full and Partial depth. For functional loads see Universal Storage Product Details.
- Apply the following upcharges for cushion fabric: C.O.M (-50), Grade B (+51), Grade C (+102), Grade D (+152), Grade E (+203)
- C.O.M for cushion require one yard of fabric for first cushion and half a yard for each additional cushion.
- Partial Depth required when modesty is applied.

21" High Hidden Drawer BF Pedestals

HIDDEN DRAWER BF PEDESTALS

H	W	D	Depth	Counterweight	Model Number	List
21	12	18	Full	Y	X-BFPH211218	1,775
21	12	23	Partial	N	X-BFPH211223	1,814
21	12	24	Full	Y	X-BFPH211224	1,895
21	16	18	Full	Y	X-BFPH211618	1,969
21	16	23	Partial	N	X-BFPH211623	2,015
21	16	24	Full	Y	X-BFPH211624	2,105
21	18	18	Full	Y	X-BFPH211818	2,022
21	18	23	Partial	N	X-BFPH211823	2,069
21	18	24	Full	Y	X-BFPH211824	2,166

HIDDEN DRAWER BF PEDESTALS ON FEET

H	W	D	Depth	Counterweight	Model Number	List
21	12	18	Full	Y	C-BFPHD211218	1,714
21	12	23	Partial	N	C-BFPHD211223	1,752
21	12	24	Full	Y	C-BFPHD211224	1,832
21	16	18	Full	Y	C-BFPHD211618	1,903
21	16	23	Partial	N	C-BFPHD211623	1,948
21	16	24	Full	Y	C-BFPHD211624	2,037
21	18	18	Full	Y	C-BFPHD211818	2,095
21	18	23	Partial	N	C-BFPHD211823	2,141
21	18	24	Full	Y	C-BFPHD211824	2,238

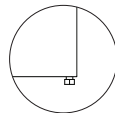
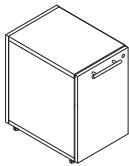

No feet.
3/8" tall glides.

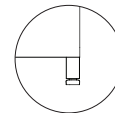
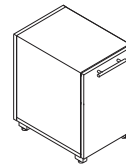

Product is elevated
on 2 1/8" tall feet.

HIDDEN DRAWER BF PEDESTALS ON CASTERS

H	W	D	No Cushion		With Cushion	
			Model Number	List	Model Number	List
21	12	18	C-BFPHD12	1,818	C-BFPHDM12	2,044
21	16	18	C-BFPHD16	2,020	C-BFPHDM16	2,271
21	18	18	C-BFPHD18	2,222	C-BFPHDM18	2,499

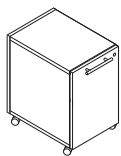

No Cushion

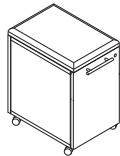

With Cushion

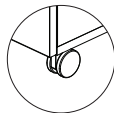

Product is elevated
on casters.

Specify

- Laminate Selection for Case
- Laminate Selection for Face/Drawer
- Handle Selection

Notes

- See Product Details for more information on how to specify Full and Partial depth. For functional loads see Universal Storage Product Details.
- Heights shown without cushions. 21" high pedestals on casters have an actual height of 22 5/8" without a cushion or 24 1/8" with a cushion.
- Partial Depth required when modesty is applied.
- Apply the following upcharges for cushion fabric: C.O.M (-50), Grade B (+51), Grade C (+102), Grade D (+152), Grade E (+203)
- C.O.M for cushion require one yard of fabric for first cushion and half a yard for each additional cushion.

21" High Cubby Pedestals

CUBBY FILE PEDESTALS ON CASTERS

H	W	D	No Cushion		With Cushion	
			Model Number	List	Model Number	List
21	12	18	C-PCUFCN122118	1,781	C-PCUFCC122118	2,003
21	16	18	C-PCUFCN162118	1,979	C-PCUFCC162118	2,225
21	18	18	C-PCUFCN182118	2,177	C-PCUFCC182118	2,447



No Cushion



With Cushion

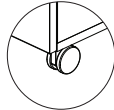

Product is elevated on casters.

BOTTOM CUBBY BOX PEDESTALS ON CASTERS

H	W	D	No Cushion		With Cushion	
			Model Number	List	Model Number	List
21	12	18	C-PCFLCN122118	1,652	C-PCFLCC122118	1,855
21	16	18	C-PCFLCN162118	1,834	C-PCFLCC162118	2,061
21	18	18	C-PCFLCN182118	2,017	C-PCFLCC182118	2,266



No Cushion



With Cushion

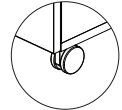

Product is elevated on casters.

CUBBY BOX PEDESTALS ON CASTERS

H	W	D	No Cushion		With Cushion	
			Model Number	List	Model Number	List
21	12	18	C-PCBBCN122118	1,875	C-PCBBCC122118	2,108
21	16	18	C-PCBBCN162118	2,084	C-PCBBCC162118	2,340
21	18	18	C-PCBBCN182118	2,291	C-PCBBCC182118	2,574



No Cushion



With Cushion

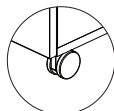

Product is elevated on casters.

CUBBY HIDDEN DRAWER BOX PEDESTALS ON CASTERS

H	W	D	No Cushion		With Cushion	
			Model Number	List	Model Number	List
21	12	18	C-PCHBCN122118	1,875	C-PCHBCC122118	2,108
21	16	18	C-PCHBCN162118	2,084	C-PCHBCC162118	2,340
21	18	18	C-PCHBCN182118	2,291	C-PCHBCC182118	2,574

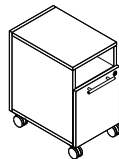

No Cushion

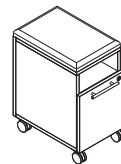

With Cushion

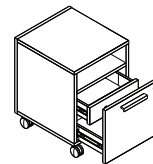

Hidden Drawer Detail

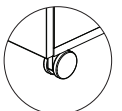

Product is elevated on casters.

Specify

- Laminate Selection for Case
- Laminate Selection for Face/Drawer
- Handle Selection

Notes

- Apply the following upcharges for cushion fabric: C.O.M (-50), Grade B (+51), Grade C (+102), Grade D (+152), Grade E (+203)
- C.O.M requires one yard of fabric for first cushion and half a yard for each additional cushion.
- Heights shown without cushions. 21" high pedestals on casters have an actual height of 22 5/8" without a cushion or 24 1/8" with a cushion.

21" High Lateral Floor Storage

BF LATERALS

H	W	D	Depth	Counterweight	Model Number	List
21	30	18	Full	Y	X-PLAT2D3018	2,575
21	36	18	Full	Y	X-PLAT2D3618	2,719
21	42	18	Full	Y	X-PLAT2D4218	2,860
21	30	22	Partial	N	X-PLAT2D3022C	2,684
21	36	22	Partial	N	X-PLAT2D3622C	2,834
21	42	22	Partial	N	X-PLAT2D4222C	2,986
21	30	24	Full	Y	X-PLAT2D3024	2,770
21	36	24	Full	Y	X-PLAT2D3624	2,931
21	42	24	Full	Y	X-PLAT2D4224	3,089

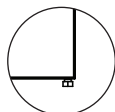
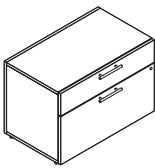

No feet.
3/8" tall glides.

BF LATERALS ON FEET

H	W	D	Depth	Counterweight	Model Number	List
21	30	18	Full	Y	C-PLATJ2D30	2,645
21	36	18	Full	Y	C-PLATJ2D36	2,789
21	42	18	Full	Y	C-PLATJ2D42	2,931
21	30	22	Partial	N	C-PLAT2D3022	2,753
21	36	22	Partial	N	C-PLAT2D3622	2,904
21	42	22	Partial	N	C-PLAT2D4222	3,055
21	30	24	Full	Y	C-PLAT2D3024	2,841
21	36	24	Full	Y	C-PLAT2D3624	2,999
21	42	24	Full	Y	C-PLAT2D4224	3,159

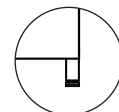
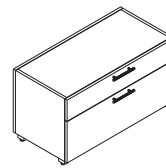

Product is elevated
on 2 1/8" tall feet.

DOUBLE PENCIL LATERALS

H	W	D	Model Number	List
21	30	36	X-PLAT2D30	3,825
21	36	36	X-PLAT2D36	4,018
21	42	36	X-PLAT2D42	4,208

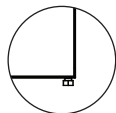
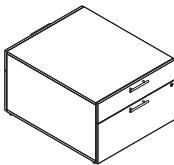

No feet.
3/8" tall glides.

DOUBLE PENCIL LATERALS ON FEET

H	W	D	Model Number	List
21	30	36	C-DPLAT2D30	3,895
21	36	36	C-DPLAT2D36	4,086
21	42	36	C-DPLAT2D42	4,281

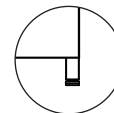
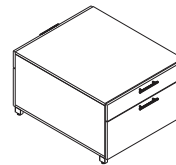

Product is elevated
on 2 1/8" tall feet.

Specify

- Laminate Selection for Case
- Laminate Selection for Face/Drawer
- Handle Selection

Notes

- Double Pencil Laterals have four drawers, two on each side.
- See Product Details for more information on how to specify Full and Partial depth. For functional loads see Universal Storage Product Details.
- See following pages for 28", 42" and 50" height in comparable storage.
- Partial Depth required when modesty is applied.
- Select sizes available on quick ship Calibrate Countdown program. See [Calibrate Countdown price list](#) for full details.

36" High Floor Bookcases

FLOOR BOOKCASES				
H	W	D	Model Number	List
36	24	18	X-CBC362418	1,510
36	30	18	X-CBC363018	1,579
36	36	18	X-CBC363618	1,857
36	42	18	X-CBC364218	1,925
36	48	18	X-CBC364818	1,998
36	54	18	X-CBC365418	2,352
36	60	18	X-CBC366018	2,423
36	66	18	X-CBC366618	2,493
36	72	18	X-CBC367218	2,562

FLOOR BOOKCASES				
H	W	D	Model Number	List
36	24	24	X-CBC362424	1,527
36	30	24	X-CBC363024	1,599
36	36	24	X-CBC363624	1,892
36	42	24	X-CBC364224	1,966
36	48	24	X-CBC364824	2,047
36	54	24	X-CBC365424	2,422
36	60	24	X-CBC366024	2,500
36	66	24	X-CBC366624	2,576
36	72	24	X-CBC367224	2,653

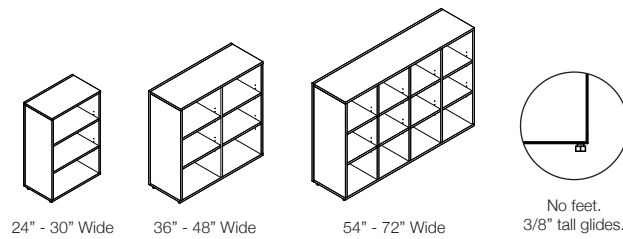

Specify

Notes

• Laminate Selection for Unit

• See following pages for 28", 42" and 50" height in comparable storage.

• Select sizes available on quick ship Calibrate Countdown program. See [Calibrate Countdown price list](#) for full details.

21" High Floor Bookcases

FLOOR BOOKCASES

H	W	D	Model Number	List
21	24	14	X-BC202414	1,379
21	30	14	X-BC203014	1,433
21	36	14	X-BC203614	1,660
21	42	14	X-BC204214	1,710
21	48	14	X-BC204814	1,767
21	54	14	X-BC205414	2,110
21	60	14	X-BC206014	2,167
21	66	14	X-BC206614	2,219
21	72	14	X-BC207214	2,270
21	24	18	X-CBC2024	1,399
21	30	18	X-CBC2030	1,466
21	36	18	X-CBC2036	1,718
21	42	18	X-CBC2042	1,778
21	48	18	X-CBC2048	1,845
21	54	18	X-CBC2054	2,166
21	60	18	X-CBC2060	2,227
21	66	18	X-CBC2066	2,295
21	72	18	X-CBC2072	2,358
21	24	24	X-CBC202424	1,399
21	30	24	X-CBC203024	1,449
21	36	24	X-CBC203624	1,716
21	42	24	X-CBC204224	1,784
21	48	24	X-CBC204824	1,845
21	54	24	X-CBC205424	2,143
21	60	24	X-CBC206024	2,211
21	66	24	X-CBC206624	2,290
21	72	24	X-CBC207224	2,361

FLOOR BOOKCASES ON FEET

H	W	D	Model Number	List
21	24	14	C-BC202414	1,448
21	30	14	C-BC203014	1,504
21	36	14	C-BC203614	1,728
21	42	14	C-BC204214	1,780
21	48	14	C-BC204814	1,838
21	54	14	C-BC205414	2,180
21	60	14	C-BC206014	2,236
21	66	14	C-BC206614	2,290
21	72	14	C-BC207214	2,339
21	24	18	C-BC202418	1,470
21	30	18	C-BC203018	1,536
21	36	18	C-BC203618	1,787
21	42	18	C-BC204218	1,848
21	48	18	C-BC204818	1,915
21	54	18	C-BC205418	2,235
21	60	18	C-BC206018	2,298
21	66	18	C-BC206618	2,366
21	72	18	C-BC207218	2,428
21	24	24	C-BC202424	1,440
21	30	24	C-BC203024	1,516
21	36	24	C-BC203624	1,780
21	42	24	C-BC204224	1,852
21	48	24	C-BC204824	1,925
21	54	24	C-BC205424	2,208
21	60	24	C-BC206024	2,280
21	66	24	C-BC206624	2,358
21	72	24	C-BC207224	2,429

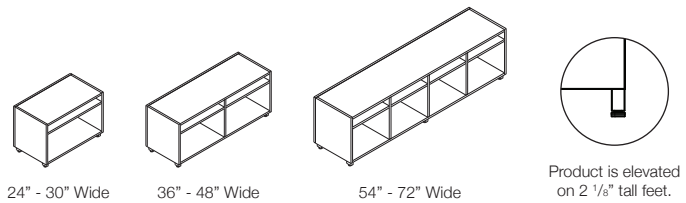
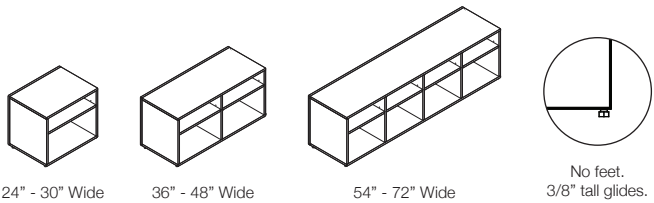

Specify **Notes**

- Laminate Selection for Unit
- See following pages for 28", 42" and 50" height in comparable storage.
- Select sizes available on quick ship Calibrate Countdown program. See [Calibrate Countdown price list](#) for full details.

21" High Floor Bookcases for Floating Tops and Shared Floor Bookcases

FLOOR BOOKCASES FOR FLOATING TOPS

H	W	D	Model Number	List
21	24	18	X-BCRO1824	1,656
21	30	18	X-BCRO1830	1,722
21	36	18	X-BCRO1836	1,845
21	24	24	X-BCRO2424	1,734
21	30	24	X-BCRO2430	1,807
21	36	24	X-BCRO2436	1,880
21	24	30	X-BCRO3024	1,844
21	30	30	X-BCRO3030	1,937
21	36	30	X-BCRO3036	2,025

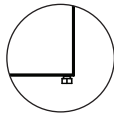
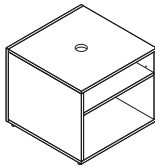

No feet.
3/8" tall glides.

FLOOR BOOKCASES FOR FLOATING TOPS ON FEET

H	W	D	Model Number	List
21	24	18	C-BCRO1824	1,725
21	30	18	C-BCRO1830	1,792
21	36	18	C-BCRO1836	1,915
21	24	24	C-BCRO2424	1,803
21	30	24	C-BCRO2430	1,878
21	36	24	C-BCRO2436	1,950
21	24	30	C-BCRO3024	1,914
21	30	30	C-BCRO3030	2,006
21	36	30	C-BCRO3036	2,096

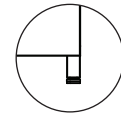
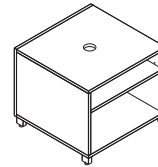

Product is elevated
on 2 1/8" tall feet.

Specify

Notes

- Laminate Selection for Unit

SHARED FLOOR BOOKCASES

H	W	D	Open Left	Open Right	List
			Model Number	Model Number	
21	36	18	X-CBCSL213618	X-CBCSR213618	1,736
21	42	18	X-CBCSL214218	X-CBCSR214218	1,798
21	48	18	X-CBCSL214818	X-CBCSR214818	1,857
21	54	18	X-CBCSL215418	X-CBCSR215418	2,179
21	60	18	X-CBCSL216018	X-CBCSR216018	2,248
21	66	18	X-CBCSL216618	X-CBCSR216618	2,311
21	72	18	X-CBCSL217218	X-CBCSR217218	2,371

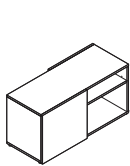

36" - 48" Wide
(Open Right)

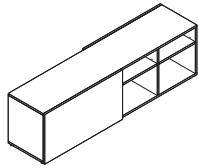

54" - 72" Wide
(Open Right)

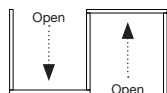

Shared Overhead View
(Open Right)

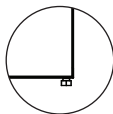

No feet.
3/8" tall glides.

SHARED FLOOR BOOKCASES ON FEET

H	W	D	Open Left	Open Right	List
			Model Number	Model Number	
21	36	18	C-YFBCL2036	C-YFBCR2036	1,805
21	42	18	C-YFBCL2042	C-YFBCR2042	1,868
21	48	18	C-YFBCL2048	C-YFBCR2048	1,928
21	54	18	C-CBCSL215418	C-CBCSR215418	2,249
21	60	18	C-YFBCL2060	C-YFBCR2060	2,319
21	66	18	C-YFBCL2066	C-YFBCR2066	2,380
21	72	18	C-YFBCL2072	C-YFBCR2072	2,441

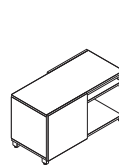

36" - 48" Wide
(Open Right)

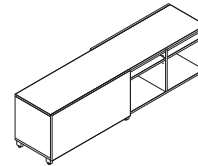

54" - 72" Wide
(Open Right)

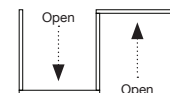

Shared Overhead View
(Open Right)

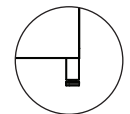

Product is elevated
on 2 1/8" tall feet.

Specify

Notes

- Laminate Selection for Case
- Laminate Selection for Face
- Open right bookcase shown.
- See following pages for 28", 42" and 50" height in comparable storage.

36" High Floor Cabinets

FOUR DOOR CABINETS – FULL DEPTH

H	W	D	Model Number	List
36	54	18	X-4CD365418	2,864
36	60	18	X-4CD366018	2,951
36	66	18	X-4CD366618	3,037
36	72	18	X-4CD367218	3,122
36	54	24	X-4CD365424	3,226
36	60	24	X-4CD366024	3,199
36	66	24	X-4CD366624	3,315
36	72	24	X-4CD367224	3,397

FOUR DOOR CABINETS – PARTIAL DEPTH

H	W	D	Model Number	List
36	54	23	X-4CD365423	3,095
36	60	23	X-4CD366023	3,181
36	66	23	X-4CD366623	3,267
36	72	23	X-4CD367223	3,353
36	54	29	X-4CD365429	3,258
36	60	29	X-4CD366029	3,346
36	66	29	X-4CD366629	3,433
36	72	29	X-4CD367229	3,516

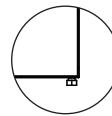
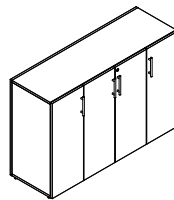

No feet.
3/8" tall glides.

Specify

- Laminate Selection for Case
- Laminate Selection for Door/Face
- Handle Selection

Notes

- See following pages for 28", 42" and 50" height in comparable storage.

21" High Floor Cabinets

TWO DOOR CABINETS

H	W	D	Model Number	List
21	24	18	X-CCD2024	1,805
21	30	18	X-CCD2030	1,885
21	36	18	X-CCD2036	2,030
21	42	18	X-CCD2042	2,106
21	48	18	X-CCD2048	2,190
21	24	24	X-CCD202424	1,913
21	30	24	X-CCD203024	1,993
21	36	24	X-CCD203624	2,138
21	42	24	X-CCD204224	2,214
21	48	24	X-CCD204824	2,298

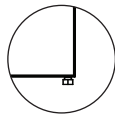
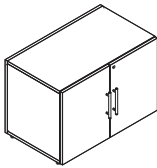

No feet.
3/8" tall glides.

FOUR DOOR CABINETS

H	W	D	Model Number	List
21	54	18	X-CCD2054	2,669
21	60	18	X-CCD2060	2,750
21	66	18	X-CCD2066	2,830
21	72	18	X-CCD2072	2,910
21	54	24	X-CCD205424	2,777
21	60	24	X-CCD206024	2,858
21	66	24	X-CCD206624	2,938
21	72	24	X-CCD207224	3,018

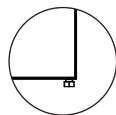
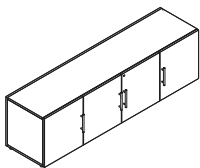

No feet.
3/8" tall glides.

TWO DOOR CABINETS ON FEET

H	W	D	Model Number	List
21	24	18	C-CC202418L	1,875
21	30	18	C-CC203018L	1,955
21	36	18	C-CC203618L	2,100
21	42	18	C-CC204218L	2,177
21	48	18	C-CC204818L	2,260

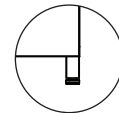
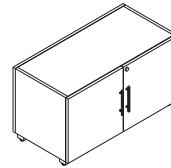

Product is elevated
on 2 1/8" tall feet.

FOUR DOOR CABINETS ON FEET

H	W	D	Model Number	List
21	54	18	C-CC205418L	2,739
21	60	18	C-CC206018L	2,820
21	66	18	C-CC206618L	2,900
21	72	18	C-CC207218L	2,978

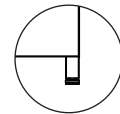
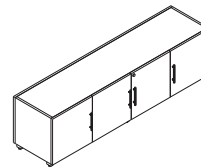

Product is elevated
on 2 1/8" tall feet.

Specify

- Laminate Selection for Case
- Laminate Selection for Door/Face
- Handle Selection

Notes

- See following pages for 28", 42" and 50" height in comparable storage.

21" High Floor Credenzas

CREDENZAS WITH SLIDING DOORS

H	W	D	Lock Type		List
			Left-Side Lock	Right-Side Lock	
			Model Number	Model Number	
21	30	18	X-CSDL2030	X-CSDR2030	2,018
21	36	18	X-CSDL2036	X-CSDR2036	2,073
21	42	18	X-CSDL2042	X-CSDR2042	2,129
21	48	18	X-CSDL2048	X-CSDR2048	2,189
21	54	18	X-CSDL2054	X-CSDR2054	2,488
21	60	18	X-CSDL2060	X-CSDR2060	2,549
21	66	18	X-CSDL2066	X-CSDR2066	2,604
21	72	18	X-CSDL2072	X-CSDR2072	2,661
21	30	24	X-CSDL203024	X-CSDR203024	2,126
21	36	24	X-CSDL203624	X-CSDR203624	2,181
21	42	24	X-CSDL204224	X-CSDR204224	2,237
21	48	24	X-CSDL204824	X-CSDR204824	2,297
21	54	24	X-CSDL205424	X-CSDR205424	2,596
21	60	24	X-CSDL206024	X-CSDR206024	2,657
21	66	24	X-CSDL206624	X-CSDR206624	2,712
21	72	24	X-CSDL207224	X-CSDR207224	2,769

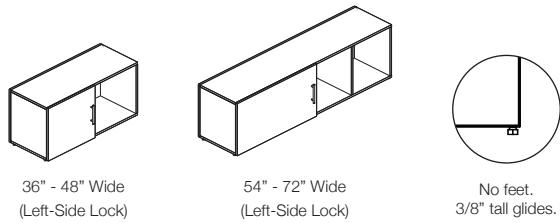

SHARED CREDENZAS WITH SLIDING DOORS

H	W	D	Lock Type		List
			Left-Side Lock	Right-Side Lock	
			Model Number	Model Number	
21	36	18	X-CBCSDSL211836	X-CBCSDSR211836	2,796
21	42	18	X-CBCSDSL211842	X-CBCSDSR211842	2,875
21	48	18	X-CBCSDSL211848	X-CBCSDSR211848	2,951
21	54	18	X-CBCSDSL211854	X-CBCSDSR211854	3,127
21	60	18	X-CBCSDSL211860	X-CBCSDSR211860	3,220
21	66	18	X-CBCSDSL211866	X-CBCSDSR211866	3,293
21	72	18	X-CBCSDSL211872	X-CBCSDSR211872	3,368

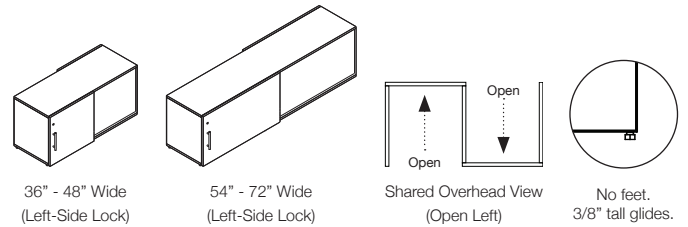

Specify

- Laminate Selection for Case
- Laminate Selection for Doors/Face
- Handle Selection

Notes

- Left-side lock shown.
- See following pages for 28", 42" and 50" height in comparable storage.

21" High Floor Credenzas

CRENZAS WITH SLIDING DOORS ON FEET

H	W	D	Lock		List
			Left-Side Lock	Right-Side Lock	
			Model Number	Model Number	
21	30	18	C-CS203018LL	C-CS203018RL	2,087
21	36	18	C-CS203618LL	C-CS203618RL	2,143
21	42	18	C-CS204218LL	C-CS204218RL	2,198
21	48	18	C-CS204818LL	C-CS204818RL	2,259
21	54	18	C-CS205418LL	C-CS205418RL	2,558
21	60	18	C-CS206018LL	C-CS206018RL	2,619
21	66	18	C-CS206618LL	C-CS206618RL	2,673
21	72	18	C-CS207218LL	C-CS207218RL	2,730

SHARED CRENZAS WITH SLIDING DOORS ON FEET

H	W	D	Lock		List
			Left-Side Lock	Right-Side Lock	
			Model Number	Model Number	
21	36	18	C-YFBCSDL2036	C-YFBCSDR2036	2,865
21	42	18	C-YFBCSDL2042	C-YFBCSDR2042	2,946
21	48	18	C-YFBCSDL2048	C-YFBCSDR2048	3,021
21	54	18	C-CBCSDSL211854	C-CBCSDSR211854	3,197
21	60	18	C-YFBCSDL2060	C-YFBCSDR2060	3,290
21	66	18	C-YFBCSDL2066	C-YFBCSDR2066	3,365
21	72	18	C-YFBCSDL2072	C-YFBCSDR2072	3,438

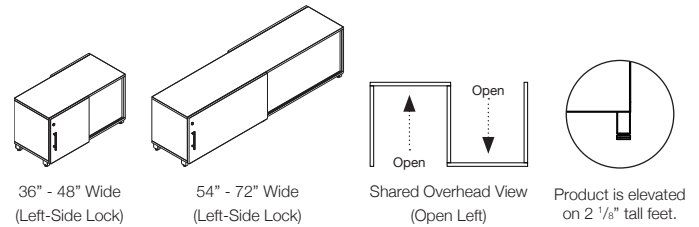
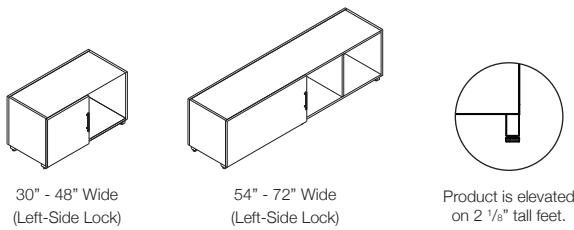

Specify

Notes

- Laminate Selection for Case
- Laminate Selection for Doors/Face
- Handle Selection
- Left-side lock shown.
- See following pages for 28", 42" and 50" height in comparable storage.

21" High Combo Units with BF Pedestal and Bookcase

COMBO UNITS WITH BF PEDESTAL AND BOOKCASE

H	W	D	Bookcase Left	Bookcase Right	List
			Model Number	Model Number	
21	30	18	X-BFCBCR213018	X-BFCBCL213018	2,249
21	36	18	X-BFCBCR213618	X-BFCBCL213618	2,385
21	42	18	X-BFCBCR214218	X-BFCBCL214218	2,520
21	48	18	X-BFCBCR214818	X-BFCBCL214818	2,588
21	54	18	X-BFCBCR215418	X-BFCBCL215418	3,136
21	60	18	X-BFCBCR216018	X-BFCBCL216018	3,203
21	66	18	X-BFCBCR216618	X-BFCBCL216618	3,451
21	72	18	X-BFCBCR217218	X-BFCBCL217218	3,515
21	30	24	X-BFCBCR213024	X-BFCBCL213024	2,408
21	36	24	X-BFCBCR213624	X-BFCBCL213624	2,544
21	42	24	X-BFCBCR214224	X-BFCBCL214224	2,680
21	48	24	X-BFCBCR214824	X-BFCBCL214824	2,753
21	54	24	X-BFCBCR215424	X-BFCBCL215424	3,350
21	60	24	X-BFCBCR216024	X-BFCBCL216024	3,422
21	66	24	X-BFCBCR216624	X-BFCBCL216624	3,674
21	72	24	X-BFCBCR217224	X-BFCBCL217224	3,737

COMBO UNITS WITH BF PEDESTAL AND BOOKCASE ON FEET

H	W	D	Bookcase Left	Bookcase Right	List
			Model Number	Model Number	
21	30	18	C-BFCBCR213018	C-BFCBCL213018	2,391
21	36	18	C-BFCBCR213618	C-BFCBCL213618	2,523
21	42	18	C-BFCBCR214218	C-BFCBCL214218	2,661
21	48	18	C-BFCBCR214818	C-BFCBCL214818	2,796
21	54	18	C-BFCBCR215418	C-BFCBCL215418	3,275
21	60	18	C-BFCBCR216018	C-BFCBCL216018	3,340
21	66	18	C-BFCBCR216618	C-BFCBCL216618	3,593
21	72	18	C-BFCBCR217218	C-BFCBCL217218	3,653
21	30	24	C-BFCBCR213024	C-BFCBCL213024	2,478
21	36	24	C-BFCBCR213624	C-BFCBCL213624	2,614
21	42	24	C-BFCBCR214224	C-BFCBCL214224	2,749
21	48	24	C-BFCBCR214824	C-BFCBCL214824	2,893
21	54	24	C-BFCBCR215424	C-BFCBCL215424	3,488
21	60	24	C-BFCBCR216024	C-BFCBCL216024	3,562
21	66	24	C-BFCBCR216624	C-BFCBCL216624	3,814
21	72	24	C-BFCBCR217224	C-BFCBCL217224	3,876

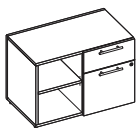

36" - 48" Wide
(Bookcase Left)

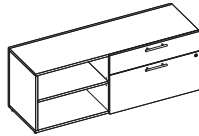

54" - 72" Wide
(Bookcase Left)

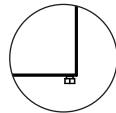

No feet.
3/8" tall glides.

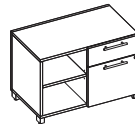

36" - 48" Wide
(Bookcase Left)

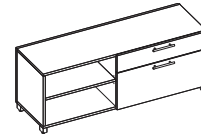

54" - 72" Wide
(Bookcase Left)

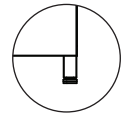

Product is elevated
on 2 1/8" tall feet.

Specify

- Laminate Selection for Case
- Laminate Selection for Drawers/Face
- Handle Selection

Notes

- On sizes 36" - 48" wide, pedestal width is 15.78 wide. On sizes 54" - 72" wide, drawer width is 30" wide.

21" High Non-Powered Access Cabinets

NON-POWERED ACCESS CABINETS WITH CLOSED BACK

H	W	D	Model Number	List
21	24	18	X-ACCB212418	1,495
21	30	18	X-ACCB213018	1,560
21	24	24	X-ACCB212424	1,516
21	30	24	X-ACCB213024	1,582

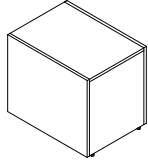

NON-POWERED ACCESS CABINETS WITH OPEN BACK

H	W	D	Model Number	List
21	24	18	X-ACOB212418	1,644
21	30	18	X-ACOB213018	1,708
21	24	24	X-ACOB212424	1,664
21	30	24	X-ACOB213024	1,727

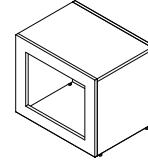

Specify

Notes

• Laminate Selection for Case

- Use under fixed-height runoffs, floating runoffs or stack-on desks for cable/power storage & access.
- Closed back units include a removable panel for access.

21" High Powered Access Cabinets

POWERED ACCESS CABINETS WITH CLOSED BACK

H	W	D	Left	Right	List	Corded Power	Hardwired Power
			Model Number	Model Number			
21	24	18	X-ACCBLP212418	X-ACCB RP212418	1,495	+998	+1,324
21	30	18	X-ACCBLP213018	X-ACCB RP213018	1,560	+998	+1,324
21	24	24	X-ACCBLP212424	X-ACCB RP212424	1,516	+998	+1,324
21	30	24	X-ACCBLP213024	X-ACCB RP213024	1,582	+998	+1,324

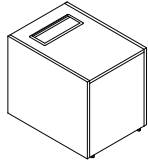

Left

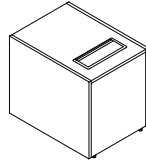

Right

POWERED ACCESS CABINETS WITH OPEN BACK

H	W	D	Left	Right	List	Corded Power	Hardwired Power
			Model Number	Model Number			
21	24	18	X-ACOB LP212418	X-ACOB RP212418	1,644	+998	+1,324
21	30	18	X-ACOB LP213018	X-ACOB RP213018	1,708	+998	+1,324
21	24	24	X-ACOB LP212424	X-ACOB RP212424	1,664	+998	+1,324
21	30	24	X-ACOB LP213024	X-ACOB RP213024	1,727	+998	+1,324

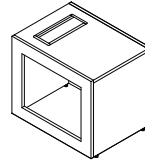

Left

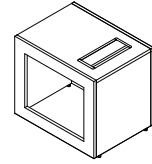

Right

Specify

Notes

- Laminate Selection for Case
- Color Selection for Power Unit - Black, Silver, White

DOUBLE POWERED ACCESS CABINETS WITH CLOSED BACK

H	W	D	Model Number	List	2 Cord Power	1 Cord Power	Hardwired Power
21	30	18	X-ACCB DP213018	1,560	+1,998	+3,824	+3,976
21	30	24	X-ACCB DP213024	1,582	+1,998	+3,824	+3,976

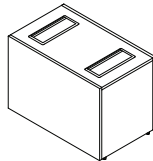

DOUBLE POWERED ACCESS CABINETS WITH OPEN BACK

H	W	D	Model Number	List	2 Cord Power	1 Cord Power	Hardwired Power
21	30	18	X-ACOB DP213018	1,708	+1,998	+3,824	+3,976
21	30	24	X-ACOB DP213024	1,727	+1,998	+3,824	+3,976

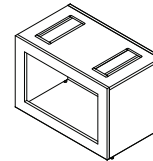

Specify

Notes

- Laminate Selection for Case
- Color Selection for Power Units - Black, Silver, White
- Use under fixed-height runoffs, floating runoffs or stack-on desks for cable/power storage & access.
- Closed back units include a removable panel for access.

28" High BBF Pedestals

BBF PEDESTALS						
H	W	D	Depth	Counterweight	Model Number	List
28	12	18	Full	Y	X-BBFPFS182812	1,539
28	12	23	Partial	N	X-BBFPFS232812	1,656
28	12	24	Full	Y	X-BBFPFS242812	1,668
28	12	29	Partial	N	X-BBFPFS292812	1,700
28	12	30	Full	Y	X-BBFPFS302812	1,722
28	16	18	Full	Y	X-BBFPFS18	1,708
28	16	23	Partial	N	X-BBFPFS23	1,839
28	16	24	Full	Y	X-BBFPFS24	1,853
28	16	29	Partial	N	X-BBFPFS29	1,887
28	16	30	Full	Y	X-BBFPFS30	1,912
28	18	18	Full	Y	X-BBFPFS182818	1,879
28	18	23	Partial	N	X-BBFPFS232818	2,023
28	18	24	Full	Y	X-BBFPFS242818	2,037
28	18	29	Partial	N	X-BBFPFS292818	2,076
28	18	30	Full	Y	X-BBFPFS302818	2,103
28	24	18	Full	Y	X-BBFPFS182824	2,068
28	24	23	Partial	N	X-BBFPFS232824	2,225
28	24	24	Full	Y	X-BBFPFS242824	2,241
28	24	29	Partial	N	X-BBFPFS292824	2,285
28	24	30	Full	Y	X-BBFPFS302824	2,313

BBF PEDESTALS ON FEET						
H	W	D	Depth	Counterweight	Model Number	List
28	12	18	Full	Y	C-BBFPFS182812	1,602
28	12	23	Partial	N	C-BBFPFS232812	1,720
28	12	24	Full	Y	C-BBFPFS242812	1,732
28	12	29	Partial	N	C-BBFPFS292812	1,762
28	12	30	Full	Y	C-BBFPFS302812	1,784
28	16	18	Full	Y	C-BBFPFS18	1,778
28	16	23	Partial	N	C-BBFPFS23	1,909
28	16	24	Full	Y	C-BBFPFS24	1,922
28	16	29	Partial	N	C-BBFPFS29	1,956
28	16	30	Full	Y	C-BBFPFS30	1,982
28	18	18	Full	Y	C-BBFPFS182818	1,955
28	18	23	Partial	N	C-BBFPFS232818	2,100
28	18	24	Full	Y	C-BBFPFS242818	2,114
28	18	29	Partial	N	C-BBFPFS292818	2,152
28	18	30	Full	Y	C-BBFPFS302818	2,180
28	24	18	Full	Y	C-BBFPFS182824	2,151
28	24	23	Partial	N	C-BBFPFS232824	2,311
28	24	24	Full	Y	C-BBFPFS242824	2,327
28	24	29	Partial	N	C-BBFPFS292824	2,369
28	24	30	Full	Y	C-BBFPFS302824	2,398

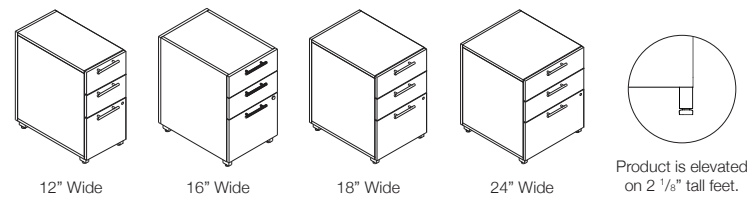
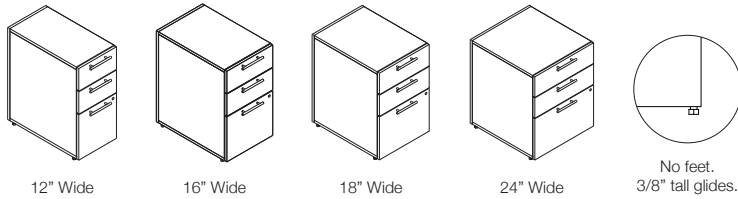

Specify

Notes

- Laminate Selection for Case
- Laminate Selection for Drawers/Face
- Handle Selection
- See Product Details for more information on how to specify Full and Partial depth.
- No caster options available, see 20" BF Pedestal on Feet if mobile pedestals sought.
- For functional loads see Universal Storage Product Details.
- Partial Depth required when modesty is applied.
- Select sizes available on quick ship Calibrate Countdown program. See [Calibrate Countdown price list](#) for full details.

28" High FF Pedestals

FF PEDESTALS

H	W	D	Depth	Counterweight	Model Number	List
28	12	18	Full	Y	X-FFPFS182812	1,509
28	12	23	Partial	N	X-FFPFS232812	1,606
28	12	24	Full	Y	X-FFPFS242812	1,625
28	12	29	Partial	N	X-FFPFS292812	1,652
28	12	30	Full	Y	X-FFPFS302812	1,664
28	16	18	Full	Y	X-FFPFS18	1,676
28	16	23	Partial	N	X-FFPFS23	1,784
28	16	24	Full	Y	X-FFPFS24	1,805
28	16	29	Partial	N	X-FFPFS29	1,835
28	16	30	Full	Y	X-FFPFS30	1,848
28	18	18	Full	Y	X-FFPFS182818	1,780
28	18	23	Partial	N	X-FFPFS232818	1,896
28	18	24	Full	Y	X-FFPFS242818	1,917
28	18	29	Partial	N	X-FFPFS292818	1,950
28	18	30	Full	Y	X-FFPFS302818	1,965
28	24	18	Full	Y	X-FFPFS182824	1,957
28	24	23	Partial	N	X-FFPFS232824	2,086
28	24	24	Full	Y	X-FFPFS242824	2,110
28	24	29	Partial	N	X-FFPFS292824	2,145
28	24	30	Full	Y	X-FFPFS302824	2,162

FF PEDESTALS ON FEET

H	W	D	Depth	Counterweight	Model Number	List
28	12	18	Full	Y	C-FFPFS182812	1,572
28	12	23	Partial	N	C-FFPFS232812	1,670
28	12	24	Full	Y	C-FFPFS242812	1,723
28	12	29	Partial	N	C-FFPFS292812	1,716
28	12	30	Full	Y	C-FFPFS302812	1,726
28	16	18	Full	Y	C-FFPFS18	1,745
28	16	23	Partial	N	C-FFPFS23	1,854
28	16	24	Full	Y	C-FFPFS24	1,914
28	16	29	Partial	N	C-FFPFS29	1,906
28	16	30	Full	Y	C-FFPFS30	1,917
28	18	18	Full	Y	C-FFPFS182818	1,854
28	18	23	Partial	N	C-FFPFS232818	1,969
28	18	24	Full	Y	C-FFPFS242818	2,035
28	18	29	Partial	N	C-FFPFS292818	2,025
28	18	30	Full	Y	C-FFPFS302818	2,038
28	24	18	Full	Y	C-FFPFS182824	2,038
28	24	23	Partial	N	C-FFPFS232824	2,167
28	24	24	Full	Y	C-FFPFS242824	2,238
28	24	29	Partial	N	C-FFPFS292824	2,226
28	24	30	Full	Y	C-FFPFS302824	2,243

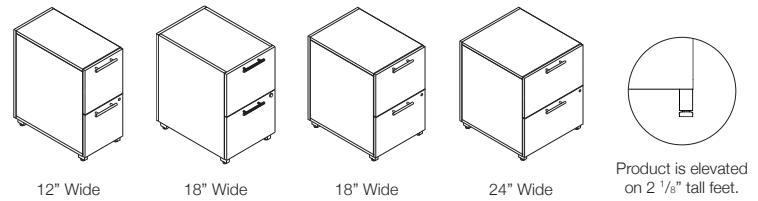
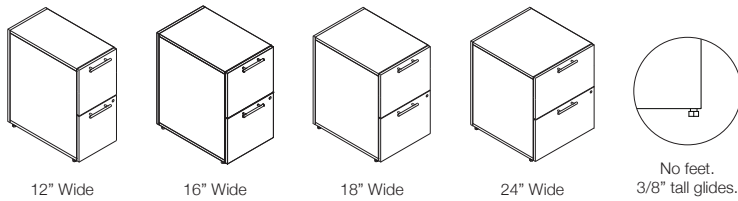

Specify

Notes

- Laminate Selection for Case
- Laminate Selection for Drawers/Face
- Handle Selection
- See Product Details for more information on how to specify Full and Partial depth.
- No caster options available, see 20" BF Pedestal on Feet if mobile pedestals sought.
- For functional loads see Universal Storage Product Details.
- Partial Depth required when modesty is applied.
- Select sizes available on quick ship Calibrate Countdown program. See [Calibrate Countdown price list](#) for full details.

28" High BBF Laterals and Two Drawer Laterals

BBF LATERALS

H	W	D	Depth	Counterweight	Model Number	List
28	30	18	Full	Y	X-BBFLAT3018	2,977
28	36	18	Full	Y	X-BBFLAT3618	3,145
28	42	18	Full	Y	X-BBFLAT4218	3,299
28	30	23	Partial	N	X-BBFLAT3023	3,131
28	36	23	Partial	N	X-BBFLAT3623	3,450
28	42	23	Partial	N	X-BBFLAT4223	3,569
28	30	24	Full	Y	X-BBFLAT3024	3,284
28	36	24	Full	Y	X-BBFLAT3624	3,478
28	42	24	Full	Y	X-BBFLAT4224	3,597
28	30	29	Partial	N	X-BBFLAT3029	3,343
28	36	29	Partial	N	X-BBFLAT3629	3,546
28	42	29	Partial	N	X-BBFLAT4229	3,671

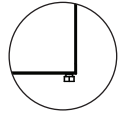
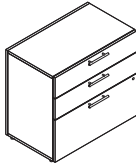

No feet.
3/8" tall glides.

BBF LATERALS ON FEET

H	W	D	Depth	Counterweight	Model Number	List
28	30	18	Full	Y	C-BBFLAT3018	2,977
28	36	18	Full	Y	C-BBFLAT3618	3,216
28	42	18	Full	Y	C-BBFLAT4218	3,369
28	30	23	Partial	N	C-BBFLAT3023	3,202
28	36	23	Partial	N	C-BBFLAT3623	3,520
28	42	23	Partial	N	C-BBFLAT4223	3,638
28	30	24	Full	Y	C-BBFLAT3024	3,284
28	36	24	Full	Y	C-BBFLAT3624	3,548
28	42	24	Full	Y	C-BBFLAT4224	3,667
28	30	29	Partial	N	C-BBFLAT3029	3,413
28	36	29	Partial	N	C-BBFLAT3629	3,615
28	42	29	Partial	N	C-BBFLAT4229	3,742

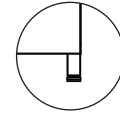

Product is elevated
on 2 1/8" tall feet.

TWO DRAWER LATERALS

H	W	D	Depth	Counterweight	Model Number	List
28	30	18	Full	Y	X-LAT2DFS3018	2,780
28	36	18	Full	Y	X-LAT2DFS3618	2,948
28	42	18	Full	Y	X-LAT2DFS4218	3,114
28	30	23	Partial	N	X-LAT2DFS3023	2,994
28	36	23	Partial	N	X-LAT2DFS3623	3,183
28	42	23	Partial	N	X-LAT2DFS4223	3,367
28	30	24	Full	Y	X-LAT2DFS3024	3,020
28	36	24	Full	Y	X-LAT2DFS3624	3,209
28	42	24	Full	Y	X-LAT2DFS4224	3,396
28	30	29	Partial	N	X-LAT2DFS3029	3,117
28	36	29	Partial	N	X-LAT2DFS3629	3,316
28	42	29	Partial	N	X-LAT2DFS4229	3,508

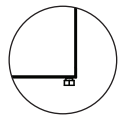
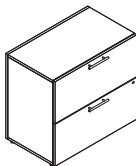

No feet.
3/8" tall glides.

TWO DRAWER LATERALS ON FEET

H	W	D	Depth	Counterweight	Model Number	List
28	30	18	Full	Y	C-LAT2D1830	2,851
28	36	18	Full	Y	C-LAT2D1836	3,017
28	42	18	Full	Y	C-LAT2D1842	3,184
28	30	23	Partial	N	C-LAT2DFS3023	3,064
28	36	23	Partial	N	C-LAT2DFS3623	3,253
28	42	23	Partial	N	C-LAT2DFS4223	3,437
28	30	24	Full	Y	C-LAT2D2430	3,088
28	36	24	Full	Y	C-LAT2D2436	3,278
28	42	24	Full	Y	C-LAT2D2442	3,465
28	30	29	Partial	N	C-LAT2DFS3029	3,186
28	36	29	Partial	N	C-LAT2DFS3629	3,385
28	42	29	Partial	N	C-LAT2DFS4229	3,577

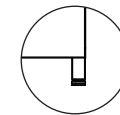
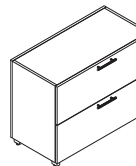

Product is elevated
on 2 1/8" tall feet.

Specify

- Laminate Selection for Case
- Laminate Selection for Drawers/Face
- Handle Selection

Notes

- See Product Details for more information on how to specify Full and Partial depth. For functional loads see Universal Storage Product Details.
- Partial Depth required when modesty is applied.
- Select sizes available on quick ship Calibrate Countdown program. See [Calibrate Countdown price list](#) for full details.

28" High Floor Bookcases

FLOOR BOOKCASES

H	W	D	Model Number	List
28	24	14	X-CBC282414	1,390
28	30	14	X-CBC283014	1,452
28	36	14	X-CBC283614	1,704
28	42	14	X-CBC284214	1,761
28	48	14	X-CBC284814	1,826
28	54	14	X-CBC285414	2,144
28	60	14	X-CBC286014	2,207
28	66	14	X-CBC286614	2,266
28	72	14	X-CBC287214	2,326
28	24	18	X-CBC282418	1,456
28	30	18	X-CBC283018	1,525
28	36	18	X-CBC283618	1,803
28	42	18	X-CBC284218	1,871
28	48	18	X-CBC284818	1,944
28	54	18	X-CBC285418	2,298
28	60	18	X-CBC286018	2,369
28	66	18	X-CBC286618	2,439
28	72	18	X-CBC287218	2,508
28	24	24	X-CBC282424	1,473
28	30	24	X-CBC283024	1,545
28	36	24	X-CBC283624	1,838
28	42	24	X-CBC284224	1,912
28	48	24	X-CBC284824	1,993
28	54	24	X-CBC285424	2,368
28	60	24	X-CBC286024	2,446
28	66	24	X-CBC286624	2,522
28	72	24	X-CBC287224	2,599

FLOOR BOOKCASES ON FEET

H	W	D	Model Number	List
28	24	14	C-BC272414	1,460
28	30	14	C-BC273014	1,521
28	36	14	C-BC273614	1,774
28	42	14	C-BC274214	1,832
28	48	14	C-BC274814	1,896
28	54	14	C-BC275414	2,214
28	60	14	C-BC276014	2,277
28	66	14	C-BC276614	2,337
28	72	14	C-BC277214	2,396
28	24	18	C-BC272418	1,525
28	30	18	C-BC273018	1,595
28	36	18	C-BC273618	1,873
28	42	18	C-BC274218	1,940
28	48	18	C-BC274818	2,015
28	54	18	C-BC275418	2,368
28	60	18	C-BC276018	2,439
28	66	18	C-BC276618	2,509
28	72	18	C-BC277218	2,577
28	24	24	C-BC272424	1,538
28	30	24	C-BC273024	1,613
28	36	24	C-BC273624	1,906
28	42	24	C-BC274224	1,979
28	48	24	C-BC274824	2,060
28	54	24	C-BC275424	2,409
28	60	24	C-BC276024	2,513
28	66	24	C-BC276624	2,590
28	72	24	C-BC277224	2,666

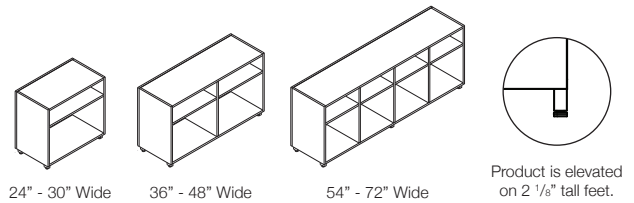
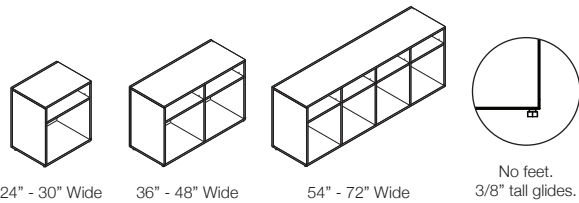

Specify

Notes

• Laminate Selection for Unit

28" High Shared Floor Bookcases

SHARED FLOOR BOOKCASES					
H	W	D	Open Left	Open Right	List
			Model Number	Model Number	
28	36	18	X-CBCSL283618	X-CBCSR283618	1,848
28	42	18	X-CBCSL284218	X-CBCSR284218	1,919
28	48	18	X-CBCSL284818	X-CBCSR284818	1,988
28	54	18	X-CBCSL285418	X-CBCSR285418	2,361
28	60	18	X-CBCSL286018	X-CBCSR286018	2,439
28	66	18	X-CBCSL286618	X-CBCSR286618	2,492
28	72	18	X-CBCSL287218	X-CBCSR287218	2,561

SHARED FLOOR BOOKCASES ON FEET					
H	W	D	Open Left	Open Right	List
			Model Number	Model Number	
28	36	18	C-YFBCL2736	C-YFBCR2736	1,917
28	42	18	C-YFBCL2742	C-YFBCR2742	1,989
28	48	18	C-YFBCL2748	C-YFBCR2748	2,059
28	54	18	C-CBCSL285418	C-CBCSR285418	2,432
28	60	18	C-YFBCL2760	C-YFBCR2760	2,509
28	66	18	C-YFBCL2766	C-YFBCR2766	2,561
28	72	18	C-YFBCL2772	C-YFBCR2772	2,631

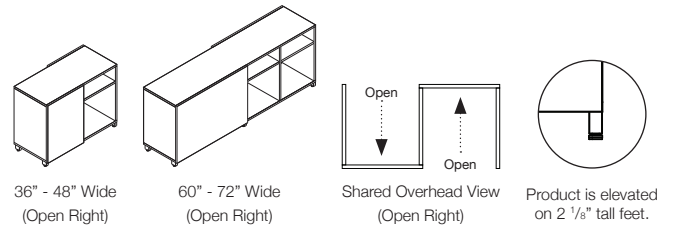
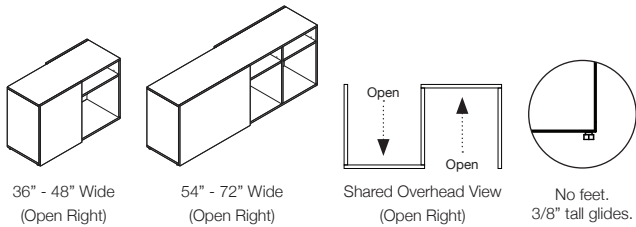

Specify

- Laminate Selection for Case
- Laminate for Face

Notes

- Open right bookcase shown.

28" High Two Door Cabinets

TWO DOOR CABINETS

H	W	D	Depth	Model Number	List
28	24	18	Full	X-DDC2418	1,876
28	30	18	Full	X-DDC3018	1,963
28	36	18	Full	X-DDC3618	2,038
28	42	18	Full	X-DDC4218	2,125
28	48	18	Full	X-DDC4818	2,212
28	24	23	Partial	X-DDC2423	2,064
28	30	23	Partial	X-DDC3023	2,166
28	36	23	Partial	X-DDC3623	2,249
28	42	23	Partial	X-DDC4223	2,341
28	48	23	Partial	X-DDC4823	2,442
28	24	24	Full	X-DDC2424	2,097
28	30	24	Full	X-DDC3024	2,198
28	36	24	Full	X-DDC3624	2,289
28	42	24	Full	X-DDC4224	2,388
28	48	24	Full	X-DDC4824	2,489
28	24	29	Partial	X-DDC2429	2,176
28	30	29	Partial	X-DDC3029	2,288
28	36	29	Partial	X-DDC3629	2,389
28	42	29	Partial	X-DDC4229	2,493
28	48	29	Partial	X-DDC4829	2,608

TWO DOOR CABINETS ON FEET

H	W	D	Depth	Model Number	List
28	24	18	Full	C-DDC2418	1,947
28	30	18	Full	C-DDC3018	2,033
28	36	18	Full	C-DDC3618	2,109
28	42	18	Full	C-DDC4218	2,192
28	48	18	Full	C-DDC4818	2,283
28	24	23	Partial	C-DDC2423	2,135
28	30	23	Partial	C-DDC3023	2,235
28	36	23	Partial	C-DDC3623	2,320
28	42	23	Partial	C-DDC4223	2,411
28	48	23	Partial	C-DDC4823	2,513
28	24	24	Full	C-DDC2424	2,167
28	30	24	Full	C-DDC3024	2,266
28	36	24	Full	C-DDC3624	2,359
28	42	24	Full	C-DDC4224	2,456
28	48	24	Full	C-DDC4824	2,559
28	24	29	Partial	C-DDC2429	2,246
28	30	29	Partial	C-DDC3029	2,358
28	36	29	Partial	C-DDC3629	2,457
28	42	29	Partial	C-DDC4229	2,562
28	48	29	Partial	C-DDC4829	2,679

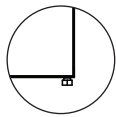
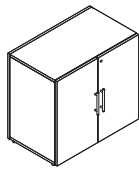

No feet.
3/8" tall glides.

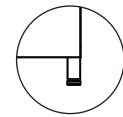
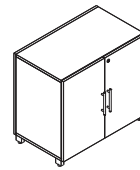

Product is elevated
on 2 1/8" tall feet.

Specify

- Laminate Selection for Case
- Laminate Selection for Doors/Face
- Handle Selection

Notes

- Units feature an adjustable shelf.
- See Product Details for more information on how to specify Full and Partial depth.
- Partial Depth required when modesty is applied.

28" High Four Door Cabinets

FOUR DOOR CABINETS				
H	W	D	Model Number	List
28	54	18	X-4DC5418	2,756
28	60	18	X-4DC6018	2,843
28	66	18	X-4DC6618	2,929
28	72	18	X-4DC7218	3,014
28	54	22	X-4DC5423	2,987
28	60	22	X-4DC6023	3,073
28	66	22	X-4DC6623	3,159
28	72	22	X-4DC7223	3,245
28	54	24	X-4DC5424	3,032
28	60	24	X-4DC6024	3,118
28	66	24	X-4DC6624	3,207
28	72	24	X-4DC7224	3,289
28	54	28	X-4DC5429	3,150
28	60	28	X-4DC6029	3,238
28	66	28	X-4DC6629	3,325
28	72	28	X-4DC7229	3,408

FOUR DOOR CABINETS ON FEET				
H	W	D	Model Number	List
28	54	18	C-4DC5418	2,826
28	60	18	C-4DC6018	2,913
28	66	18	C-4DC6618	2,997
28	72	18	C-4DC7218	3,083
28	54	22	C-4DC5423	3,057
28	60	22	C-4DC6023	3,143
28	66	22	C-4DC6623	3,228
28	72	22	C-4DC7223	3,314
28	54	24	C-4DC5424	3,103
28	60	24	C-4DC6024	3,188
28	66	24	C-4DC6624	3,276
28	72	24	C-4DC7224	3,359
28	54	28	C-4DC5429	3,220
28	60	28	C-4DC6029	3,306
28	66	28	C-4DC6629	3,396
28	72	28	C-4DC7229	3,478

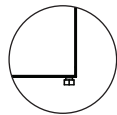
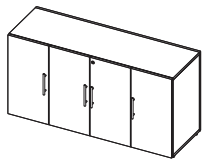

No feet.
3/8" tall glides.

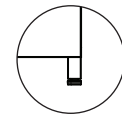
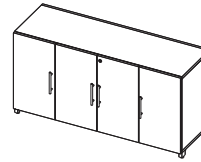

Product is elevated
on 2 1/8" tall feet.

Specify

Notes

- Laminate Selection for Case
- Laminate Selection for Doors/Face
- Handle Selection

28" High Single Door Cabinets and Credenzas with Cabinet Doors

SINGLE DOOR CABINETS

H	W	D	Left-Hinge	Right-Hinge	List
			Model Number	Model Number	
28	15	18	X-SDCL2718	X-SDCR2718	1,584
28	15	24	X-SDCL2724	X-SDCR2724	1,660
28	15	30	X-SDCL2730	X-SDCR2730	1,736

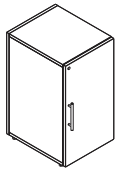

(Right Hinge)

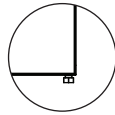

No feet.
3/8" tall glides.

SINGLE DOOR CABINETS ON FEET

H	W	D	Hinge Left	Hinge Right	List
			Model Number	Model Number	
28	15.5	18	C-SDC271518LL	C-SDC271518RL	1,653
28	15.5	24	C-SDC271524LL	C-SDC271524RL	1,728
28	15.5	30	C-SDC271530LL	C-SDC271530RL	1,805

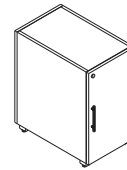

(Right Hinge)

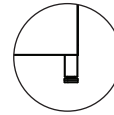

Product is elevated
on 2 1/8" tall feet.

Specify

Notes

- Laminate Selection for Case
- Laminate Selection for Doors/Face
- Handle Selection

Right-hinge shown.

CREDENZAS WITH CABINET DOORS

H	W	D	Model Number	List
28	24	18	X-CCD2724	2,004
28	30	18	X-CCD2730	2,094
28	36	18	X-CCD2736	2,248
28	42	18	X-CCD2742	2,331
28	48	18	X-CCD2748	2,422
28	54	18	X-CCD2754	2,965
28	60	18	X-CCD2760	3,053
28	66	18	X-CCD2766	3,139
28	72	18	X-CCD2772	3,222

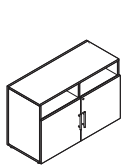

36" - 48" Wide

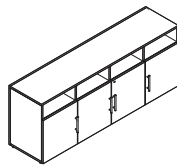

54" - 72" Wide

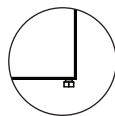

No feet.
3/8" tall glides.

CREDENZAS WITH CABINET DOORS ON FEET

H	W	D	Model Number	List
28	24	18	C-CC272418L	2,073
28	30	18	C-CC273018L	2,162
28	36	18	C-CC273618L	2,319
28	42	18	C-CC274218L	2,401
28	48	18	C-CC274818L	2,492
28	54	18	C-CC275418L	3,034
28	60	18	C-CC276018L	3,122
28	66	18	C-CC276618L	3,209
28	72	18	C-CC277218L	3,292

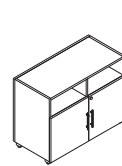

36" - 48" Wide

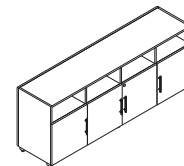

54" - 72" Wide

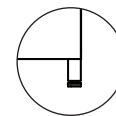

Product is elevated
on 2 1/8" tall feet.

Specify

Notes

- Laminate Selection for Case
- Laminate Selection for Doors/Face
- Handle Selection

28" High Credenzas with Sliding Doors

CREDENZAS WITH SLIDING DOORS

H	W	D	Left-Side Lock	Right-Side Lock	List
			Model Number	Model Number	
28	30	18	X-CSDL2730	X-CSDR2730	2,406
28	36	18	X-CSDL2736	X-CSDR2736	2,480
28	42	18	X-CSDL2742	X-CSDR2742	2,557
28	48	18	X-CSDL2748	X-CSDR2748	2,636
28	54	18	X-CSDL2754	X-CSDR2754	2,896
28	60	18	X-CSDL2760	X-CSDR2760	2,975
28	66	18	X-CSDL2766	X-CSDR2766	3,053
28	72	18	X-CSDL2772	X-CSDR2772	3,126

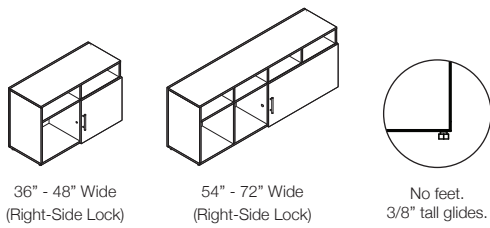

CREDENZAS WITH SLIDING DOORS ON FEET

H	W	D	Left-Side Lock	Right-Side Lock	List
			Model Number	Model Number	
28	30	18	C-CS273018LL	C-CS273018RL	2,476
28	36	18	C-CS273618LL	C-CS273618RL	2,551
28	42	18	C-CS274218LL	C-CS274218RL	2,627
28	48	18	C-CS274818LL	C-CS274818RL	2,706
28	54	18	C-CS275418LL	C-CS275418RL	2,966
28	60	18	C-CS276018LL	C-CS276018RL	3,044
28	66	18	C-CS276618LL	C-CS276618RL	3,122
28	72	18	C-CS277218LL	C-CS277218RL	3,195

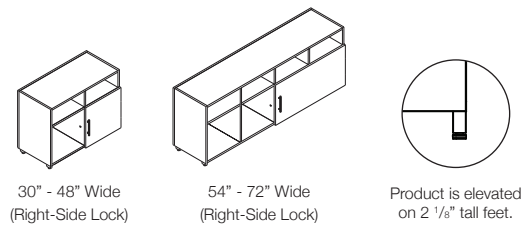

SHARED CREDENZAS WITH SLIDING DOORS

H	W	D	Left-Side Lock	Right-Side Lock	List
			Model Number	Model Number	
28	36	18	X-CBCSDSL281836	X-CBCSDSR281836	3,007
28	42	18	X-CBCSDSL281842	X-CBCSDSR281842	3,122
28	48	18	X-CBCSDSL281848	X-CBCSDSR281848	3,215
28	54	18	X-CBCSDSL281854	X-CBCSDSR281854	3,475
28	60	18	X-CBCSDSL281860	X-CBCSDSR281860	3,586
28	66	18	X-CBCSDSL281866	X-CBCSDSR281866	3,678
28	72	18	X-CBCSDSL281872	X-CBCSDSR281872	3,773

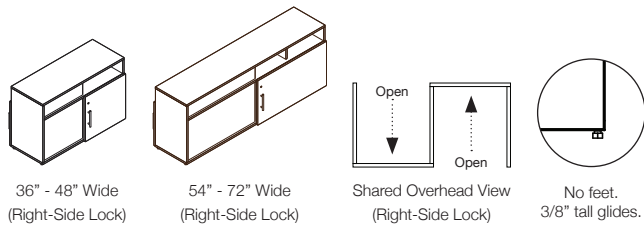

SHARED CREDENZAS WITH SLIDING DOORS ON FEET

H	W	D	Left-Side Lock	Right-Side Lock	List
			Model Number	Model Number	
28	36	18	C-YFBCSDL2736	C-YFBCSDR2736	3,076
28	42	18	C-YFBCSDL2742	C-YFBCSDR2742	3,190
28	48	18	C-YFBCSDL2748	C-YFBCSDR2748	3,285
28	54	18	C-CBCSDSL281854	C-CBCSDSR281854	3,545
28	60	18	C-YFBCSDL2760	C-YFBCSDR2760	3,657
28	66	18	C-YFBCSDL2766	C-YFBCSDR2766	3,748
28	72	18	C-YFBCSDL2772	C-YFBCSDR2772	3,842

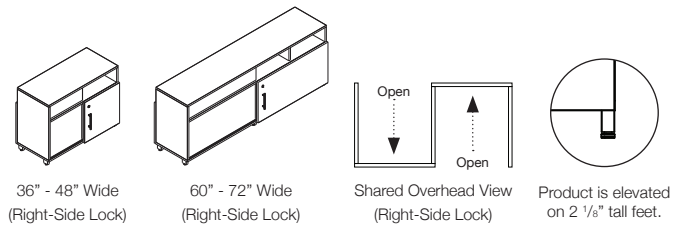

Specify

- Laminate Selection for Case
- Laminate Selection for Door/Face
- Handle Selection

Notes

- Right-side lock credenza shown.

28" High Combo BBF and Combo FF Storage

COMBO BBF WITH DOOR

H	W	D	Door	Depth	Counter-weight	Model Number	List
28	30	18	Right	Full	Y	X-BBFLCR18	2,622
28	30	23	Right	Partial	N	X-BBFLCR23	2,820
28	30	24	Right	Full	Y	X-BBFLCR24	2,852
28	30	29	Right	Partial	N	X-BBFLCR29	2,925
28	30	18	Left	Full	Y	X-BBFRCL18	2,622
28	30	23	Left	Partial	N	X-BBFRCL23	2,820
28	30	24	Left	Full	Y	X-BBFRCL24	2,833
28	30	29	Left	Partial	N	X-BBFRCL29	2,925

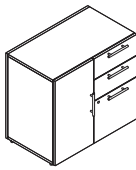

(Door Left)

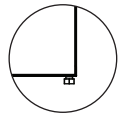

No feet.
3/8" tall glides.

COMBO BBF WITH DOOR ON FEET

H	W	D	Door	Depth	Counter-weight	Model Number	List
28	30	18	Right	Full	Y	C-BBFLCR18	2,691
28	30	23	Right	Partial	N	C-BBFLCR23	2,891
28	30	24	Right	Full	Y	C-BBFLCR24	2,921
28	30	29	Right	Partial	N	C-BBFLCR29	2,994
28	30	18	Left	Full	Y	C-BBFRCL18	2,691
28	30	23	Left	Partial	N	C-BBFRCL23	2,891
28	30	24	Left	Full	Y	C-BBFRCL24	2,921
28	30	29	Left	Partial	N	C-BBFRCL29	2,994

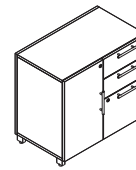

(Door Left)

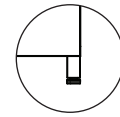

Product is elevated
on 2 1/8" tall feet.

COMBO FF WITH DOOR

H	W	D	Door	Depth	Counter-weight	Model Number	List
28	30	18	Right	Full	Y	X-FFLCR18	2,561
28	30	23	Right	Partial	N	X-FFLCR23	2,748
28	30	24	Right	Full	Y	X-FFLCR24	2,778
28	30	29	Right	Partial	N	X-FFLCR29	2,853
28	30	18	Left	Full	Y	X-FFRCL18	2,561
28	30	23	Left	Partial	N	X-FFRCL23	2,748
28	30	24	Left	Full	Y	X-FFRCL24	2,778
28	30	29	Left	Partial	N	X-FFRCL29	2,853

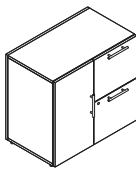

(Door Left)

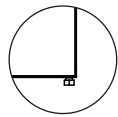

No feet.
3/8" tall glides.

COMBO FF WITH DOOR ON FEET

H	W	D	Door	Depth	Counter-weight	Model Number	List
28	30	18	Right	Full	Y	C-FFLCR18	2,631
28	30	23	Right	Partial	N	C-FFLCR23	2,817
28	30	24	Right	Full	Y	C-FFLCR24	2,846
28	30	29	Right	Partial	N	C-FFLCR29	2,922
28	30	18	Left	Full	Y	C-FFRCL18	2,631
28	30	23	Left	Partial	N	C-FFRCL23	2,817
28	30	24	Left	Full	Y	C-FFRCL24	2,846
28	30	29	Left	Partial	N	C-FFRCL29	2,922

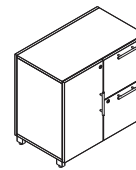

(Door Left)

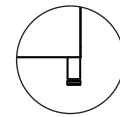

Product is elevated
on 2 1/8" tall feet.

Specify

- Laminate Selection for Case
- Laminate Selection for Drawer/Doors/Face
- Handle Selection

Notes

- See Product Details for more information on how to specify Full and Partial depth.
- Partial Depth required when modesty is applied.

28" High Combo Laterals

COMBO LATERALS WITH BB AND DOOR

H	W	D	Door	Depth	Counter-weight	Model Number	List
28	30	18	Right	Full	Y	X-BBLCR3018	2,947
28	30	23	Right	Partial	N	X-BBLCR3023	3,229
28	30	24	Right	Full	Y	X-BBLCR3024	3,263
28	30	29	Right	Partial	N	X-BBLCR3029	3,344
28	30	18	Left	Full	Y	X-BBRCL3018	2,947
28	30	23	Left	Partial	N	X-BBRCL3023	3,229
28	30	24	Left	Full	Y	X-BBRCL3024	3,263
28	30	29	Left	Partial	N	X-BBRCL3029	3,344

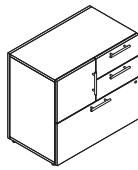

(Door Left)

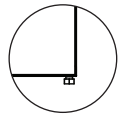

No feet.
3/8" tall glides.

COMBO LATERALS WITH BB AND DOOR ON FEET

H	W	D	Door	Depth	Counter-weight	Model Number	List
28	30	18	Right	Full	Y	C-BBLCR3018	3,016
28	30	23	Right	Partial	N	C-BBLCR3023	3,300
28	30	24	Right	Full	Y	C-BBLCR3024	3,334
28	30	29	Right	Partial	N	C-BBLCR3029	3,414
28	30	18	Left	Full	Y	C-BBRCL3018	3,016
28	30	23	Left	Partial	N	C-BBRCL3023	3,229
28	30	24	Left	Full	Y	C-BBRCL3024	3,334
28	30	29	Left	Partial	N	C-BBRCL3029	3,414

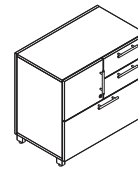

(Door Left)

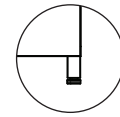

Product is elevated
on 2 1/8" tall feet.

COMBO LATERALS WITH BOTTOM LATERAL AND TOP DOORS

H	W	D	Depth	Counterweight	Model Number	List
28	30	18	Full	Y	X-CTLB3018	2,642
28	36	18	Full	Y	X-CTLB3618	2,797
28	42	18	Full	Y	X-CTLB4218	2,952
28	30	23	Partial	N	X-CTLB3023	2,855
28	36	23	Partial	N	X-CTLB3623	3,031
28	42	23	Partial	N	X-CTLB4223	3,197
28	30	24	Full	Y	X-CTLB3024	2,886
28	36	24	Full	Y	X-CTLB3624	3,063
28	42	24	Full	Y	X-CTLB4224	3,247
28	30	29	Partial	N	X-CTLB3029	2,961
28	36	29	Partial	N	X-CTLB3629	3,149
28	42	29	Partial	N	X-CTLB4229	3,331

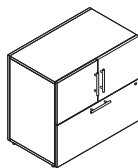

(Door Left)

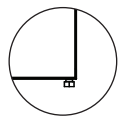

No feet.
3/8" tall glides.

COMBO LATERALS WITH BOTTOM LATERAL AND TOP DOORS ON FEET

H	W	D	Depth	Counterweight	Model Number	List
28	30	18	Full	Y	C-CTLB3018	2,712
28	36	18	Full	Y	C-CTLB3618	2,866
28	42	18	Full	Y	C-CTLB4218	3,022
28	30	23	Partial	N	C-CTLB3023	2,925
28	36	23	Partial	N	C-CTLB3623	3,102
28	42	23	Partial	N	C-CTLB4223	3,266
28	30	24	Full	Y	C-CTLB3024	2,955
28	36	24	Full	Y	C-CTLB3624	3,135
28	42	24	Full	Y	C-CTLB4224	3,316
28	30	29	Partial	N	C-CTLB3029	3,031
28	36	29	Partial	N	C-CTLB3629	3,219
28	42	29	Partial	N	C-CTLB4229	3,401

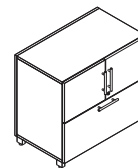

(Door Left)

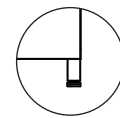

Product is elevated
on 2 1/8" tall feet.

Specify

- Laminate Selection for Case
- Laminate Selection for Drawer/Doors/Face
- Handle Selection

Notes

- See Product Details for more information on how to specify Full and Partial depth.
- Combo lateral box drawers do not lock.
- Partial Depth required when modesty is applied.

42" and 50" High Lateral Bookcases

LATERAL BOOKCASES

H	W	D	Model Number	List
42	30	18	X-LATBC4230	3,276
42	36	18	X-LATBC4236	3,445
42	42	18	X-LATBC4242	3,609
50	30	18	X-LATBC5030	3,374
50	36	18	X-LATBC5036	3,552
50	42	18	X-LATBC5042	3,720

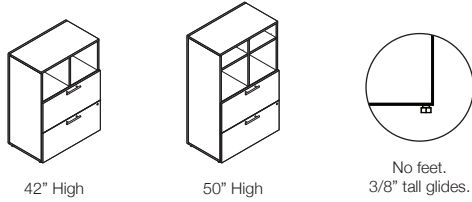

LATERAL BOOKCASES ON FEET

H	W	D	Model Number	List
42	30	18	C-SLTT42BC30	3,344
42	36	18	C-SLTT42BC36	3,515
42	42	18	C-SLTT42BC42	3,678
50	30	18	C-SLTT50BC30	3,445
50	36	18	C-SLTT50BC36	3,622
50	42	18	C-SLTT50BC42	3,790

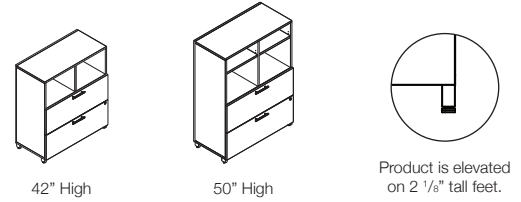

Specify Notes

- Laminate Selection for Case
- Laminate Selection for Drawers/Face
- Handle Selection

SHARED LATERAL BOOKCASES

H	W	D	Open Left	Open Right	List
			Model Number	Model Number	
42	30	18	X-SLATBCL4230	X-SLATBCR4230	3,417
42	36	18	X-SLATBCL4236	X-SLATBCR4236	3,609
42	42	18	X-SLATBCL4242	X-SLATBCR4242	3,795
50	30	18	X-SLATBCL5030	X-SLATBCR5030	3,508
50	36	18	X-SLATBCL5036	X-SLATBCR5036	3,706
50	42	18	X-SLATBCL5042	X-SLATBCR5042	3,897

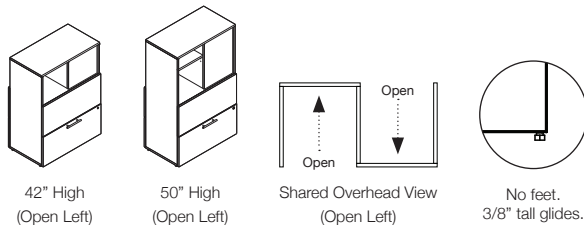

SHARED LATERAL BOOKCASES ON FEET

H	W	D	Open Left	Open Right	List
			Model Number	Model Number	
42	30	18	C-YLTT42BCL30	C-YLTT42BCR30	3,487
42	36	18	C-YLTT42BCL36	C-YLTT42BCR36	3,678
42	42	18	C-YLTT42BCL42	C-YLTT42BCR42	3,864
50	30	18	C-YLTT50BCL30	C-YLTT50BCR30	3,577
50	36	18	C-YLTT50BCL36	C-YLTT50BCR36	3,776
50	42	18	C-YLTT50BCL42	C-YLTT50BCR42	3,966

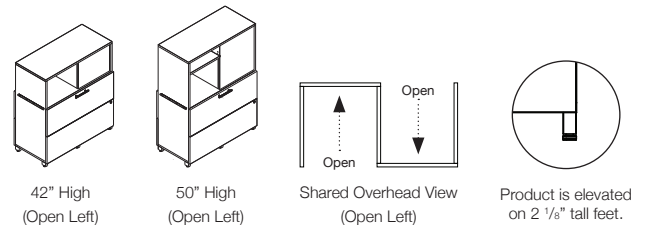

Specify Notes

- Laminate Selection for Case
- Laminate Selection for Doors/Face
- Laminate Selection for Divider
- Handle Selection
- Dry-Erase Writable Surface Option
- Open left hand lateral bookcase shown.
- Open right hand lateral bookcase on feet shown.

42" and 50" High Laterals with Sliding Doors

LATERALS WITH SLIDING DOORS					
H	W	D	Left-Side Lock	Right-Side Lock	List
			Model Number	Model Number	
42	30	18	X-LATSDL4230	X-LATSDR4230	3,820
42	36	18	X-LATSDL4236	X-LATSDR4236	3,996
42	42	18	X-LATSDL4242	X-LATSDR4242	4,166
50	30	18	X-LATSDL5030	X-LATSDR5030	3,905
50	36	18	X-LATSDL5036	X-LATSDR5036	4,092
50	42	18	X-LATSDL5042	X-LATSDR5042	4,266



42" High
(Right-Side Lock)

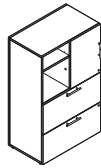

50" High
(Right-Side Lock)

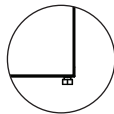

No feet.
3/8" tall glides.

LATERALS WITH SLIDING DOORS ON FEET					
H	W	D	Left-Side Lock	Right-Side Lock	List
			Model Number	Model Number	
42	30	18	C-SLTTSDL42BC30	C-SLTTSDR42BC30	3,891
42	36	18	C-SLTTSDL42BC36	C-SLTTSDR42BC36	4,067
42	42	18	C-SLTTSDL42BC42	C-SLTTSDR42BC42	4,235
50	30	18	C-SLTTSDL50BC30	C-SLTTSDR50BC30	3,974
50	36	18	C-SLTTSDL50BC36	C-SLTTSDR50BC36	4,161
50	42	18	C-SLTTSDL50BC42	C-SLTTSDR50BC42	4,337

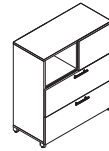

42" High
(Right-Side Lock)

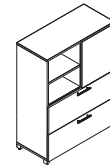

50" High
(Right-Side Lock)

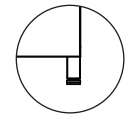

Product is elevated
on 2 1/8" tall feet.

Specify

Notes

- Laminate Selection for Case
- Laminate Selection for Drawers/Doors/Face
- Handle Selection

- Right-side lock lateral shown.

SHARED LATERALS WITH SLIDING DOORS					
H	W	D	Left-Side Lock	Right-Side Lock	List
			Model Number	Model Number	
42	30	18	X-SLATSDL4230	X-SLATSDR4230	4,435
42	36	18	X-SLATSDL4236	X-SLATSDR4236	4,638
42	42	18	X-SLATSDL4242	X-SLATSDR4242	4,837
50	30	18	X-SLATSDL5030	X-SLATSDR5030	4,493
50	36	18	X-SLATSDL5036	X-SLATSDR5036	4,711
50	42	18	X-SLATSDL5042	X-SLATSDR5042	4,922

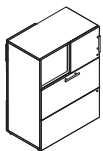

42" High
(Right-Side Lock)

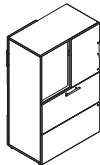

50" High
(Right-Side Lock)

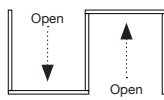

Shared Overhead View
(Right-Side Lock)

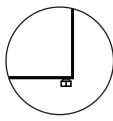

No feet.
3/8" tall glides.

SHARED LATERALS WITH SLIDING DOORS ON FEET					
H	W	D	Left-Side Lock	Right-Side Lock	List
			Model Number	Model Number	
42	30	18	C-YLTT42SDL30	C-YLTT42SDR30	4,505
42	36	18	C-YLTT42SDL36	C-YLTT42SDR36	4,708
42	42	18	C-YLTT42SDL42	C-YLTT42SDR42	4,907
50	30	18	C-YLTT50SDL30	C-YLTT50SDR30	4,563
50	36	18	C-YLTT50SDL36	C-YLTT50SDR36	4,782
50	42	18	C-YLTT50SDL42	C-YLTT50SDR42	4,992

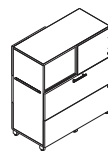

42" High
(Right-Side Lock)

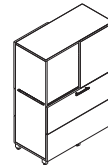

50" High
(Right-Side Lock)

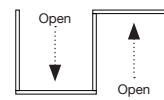

Shared Overhead View
(Right-Side Lock)

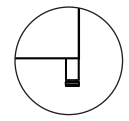

Product is elevated
on 2 1/8" tall feet.

Specify

Notes

- Laminate Selection for Case
- Laminate Selection for Drawers/Doors/Face
- Laminate Selection for Divider
- Handle Selection
- Dry-Erase Writable Surface Option

- Right-side lock lateral shown.

42" and 50" Two Door Cabinets

TWO DOOR CABINETS

H	W	D	Model Number	List
42	30	18	X-CBC423018	2,287
42	30	24	X-CBC423024	2,452
42	30	30	X-CBC423030	2,624
42	36	18	X-CBC423618	2,410
42	36	24	X-CBC423624	2,595
42	36	30	X-CBC423630	2,786
50	30	18	X-CBC503018	2,530
50	30	24	X-CBC503024	2,708
50	30	30	X-CBC503030	2,894
50	36	18	X-CBC503618	2,666
50	36	24	X-CBC503624	2,864
50	36	30	X-CBC503630	3,069

TWO DOOR CABINETS ON FEET

H	W	D	Model Number	List
42	30	18	C-CBC423018	2,357
42	30	24	C-CBC423024	2,522
42	30	30	C-CBC423030	2,693
42	36	18	C-CBC423618	2,480
42	36	24	C-CBC423624	2,665
42	36	30	C-CBC423630	2,856
50	30	18	C-CBC503018	2,599
50	30	24	C-CBC503024	2,779
50	30	30	C-CBC503030	2,964
50	36	18	C-CBC503618	2,736
50	36	24	C-CBC503624	2,933
50	36	30	C-CBC503630	3,139

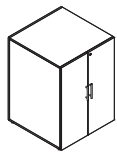

42" High

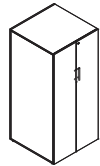

50" High

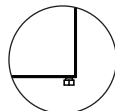

No feet.
3/8" tall glides.

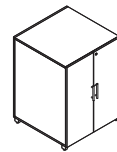

42" High

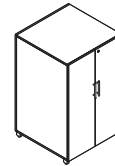

50" High

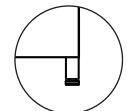

Product is elevated
on 2 1/8" tall feet.

Specify

Notes

- Laminate Selection for Case
- Laminate Selection for Doors/Face
- Handle Selection

- 42" high units include 2 adjustable shelves and 50" high units include 3 adjustable shelves.

27", 42", 50" High Side Access Roll Out / Pantry Towers

SIDE ACCESS ROLL OUT / PANTRY TOWERS					
H	W	D	Left-Handed	Right-Handed	List
			Model Number	Model Number	
27	15.75	24	X-SARTL271524	X-SARTR271524	3,553
27	15.75	30	X-SARTL271530	X-SARTR271530	3,729
27	18	24	X-SARTL271824	X-SARTR271824	3,731
27	18	30	X-SARTL271830	X-SARTR271830	3,913
42	15.75	24	X-SARTL421524	X-SARTR421524	4,419
42	15.75	30	X-SARTL421530	X-SARTR421530	4,599
50	15.75	24	X-SARTL501524	X-SARTR501524	4,852
50	15.75	30	X-SARTL501530	X-SARTR501530	4,987

FILE BARS FOR SIDE ACCESS ROLL-OUT TOWERS

Model Number	List
A-SAROTPR	356

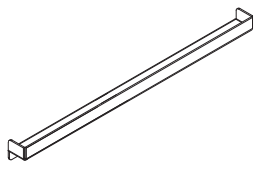
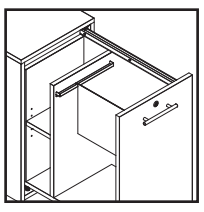
Specify	Notes
• Paint Selection	• File bars are sold as pairs.

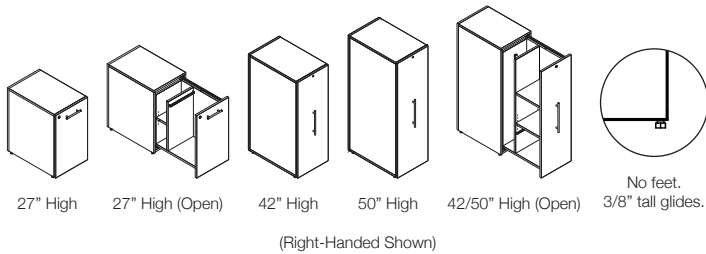

Specify	Notes
<ul style="list-style-type: none"> • Laminate Selection for Case • Laminate Selection for Doors/Face • Handle Selection (for 27" high units only) 	<ul style="list-style-type: none"> • Right-handed tower shown. • Side Access Roll Out/Pantry Towers are on 3/8" tall glides only, not available on feet. • 42" and 50" high units are standard with a 15" vertical bar pull. • File bars are included with 27" high units. • Coat hook included with all units. • Outer and inner case will always be the same laminate color. Door/face can be specified as a separate laminate color than case. • Important: Side Access Roll Out/Pantry Towers have anti-tip front roller which can leave wear marks on floor over time.

42" Three Drawer Laterals and 54" Four Drawer Laterals

42" HIGH THREE DRAWER LATERAL

H	W	D	Model Number	List
42	30	18	X-LAT3DFS3018	3,985
42	30	24	X-LAT3DFS3024	4,343
42	36	18	X-LAT3DFS3618	4,202
42	36	24	X-LAT3DFS3624	4,588
42	42	18	X-LAT3DFS4218	4,420
42	42	24	X-LAT3DFS4224	4,827

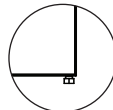

No feet.
3/8" tall glides.

42" HIGH THREE DRAWER LATERAL ON FEET

H	W	D	Model Number	List
42	30	18	C-LAT3DFS3018	4,055
42	30	24	C-LAT3DFS3024	4,413
42	36	18	C-LAT3DFS3618	4,271
42	36	24	C-LAT3DFS3624	4,659
42	42	18	C-LAT3DFS4218	4,490
42	42	24	C-LAT3DFS4224	4,898

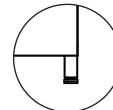
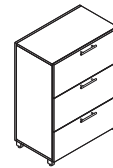

Product is elevated
on 2 1/8" tall feet.

54" HIGH FOUR DRAWER LATERAL

H	W	D	Model Number	List
54	30	18	X-LAT4DFS3018	4,519
54	30	24	X-LAT4DFS3024	4,903
54	36	18	X-LAT4DFS3618	4,751
54	36	24	X-LAT4DFS3624	5,161
54	42	18	X-LAT4DFS4218	4,989
54	42	24	X-LAT4DFS4224	5,421

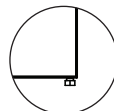
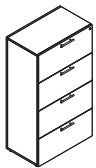

No feet.
3/8" tall glides.

54" HIGH FOUR DRAWER LATERAL ON FEET

H	W	D	Model Number	List
54	30	18	C-LAT4DFS3018	4,589
54	30	24	C-LAT4DFS3024	4,973
54	36	18	C-LAT4DFS3618	4,822
54	36	24	C-LAT4DFS3624	5,230
54	42	18	C-LAT4DFS4218	5,060
54	42	24	C-LAT4DFS4224	5,491

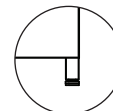
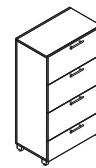

Product is elevated
on 2 1/8" tall feet.

Specify

Notes

- Laminate Selection for Case
- Laminate Selection for Drawers/Face
- Handle Selection

BF Wardrobe Towers

BF WARDROBE TOWERS WITH OPEN FRONT

H	W	D	Wardrobe Left	Wardrobe Right	List
			Model Number	Model Number	
50	24	24	X-WLBFOF50	X-WRBFOF50	3,501
66	24	24	X-WLBFOF66	X-WRBFOF66	3,780
74	24	24	X-WLBFOF74	X-WRBFOF74	3,945
82	24	24	X-WLBFOF82	X-WRBFOF82	4,071

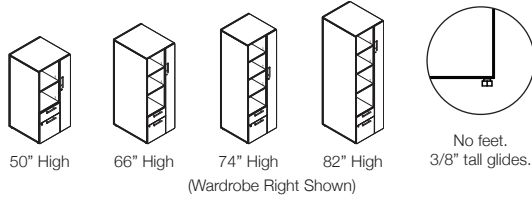

BF WARDROBE TOWERS WITH OPEN FRONT ON FEET

H	W	D	Wardrobe Left	Wardrobe Right	List
			Model Number	Model Number	
50	24	24	C-WLBFOF50	C-WRBFOF50	3,571
66	24	24	C-WLBFOF66	C-WRBFOF66	3,852

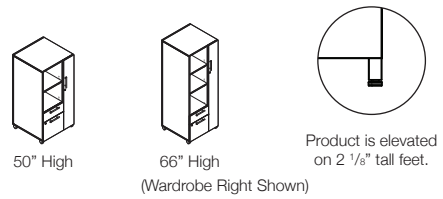

BF WARDROBE TOWERS WITH OPEN SIDE

H	W	D	Wardrobe Left	Wardrobe Right	List
			Model Number	Model Number	
50	24	24	X-WLBFOS50	X-WRBFOS50	3,577
66	24	24	X-WLBFOS66	X-WRBFOS66	3,879
74	24	24	X-WLBFOS74	X-WRBFOS74	3,992
82	24	24	X-WLBFOS82	X-WRBFOS82	4,181

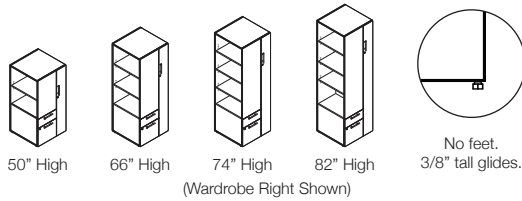

BF WARDROBE TOWERS WITH OPEN SIDE ON FEET

H	W	D	Wardrobe Left	Wardrobe Right	List
			Model Number	Model Number	
50	24	24	C-WLBFOS50	C-WRBFOS50	3,647
66	24	24	C-WLBFOS66	C-WRBFOS66	3,948

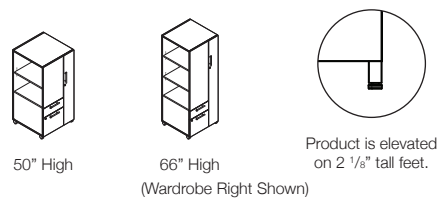

BF WARDROBE TOWERS WITH CUPBOARD

H	W	D	Wardrobe Left	Wardrobe Right	List
			Model Number	Model Number	
50	24	24	X-WBFCDL50	X-WBFCDR50	3,734
66	24	24	X-WBFCDL66	X-WBFCDR66	4,103
74	24	24	X-WBFCDL74	X-WBFCDR74	4,265
82	24	24	X-WBFCDL82	X-WBFCDR82	4,476

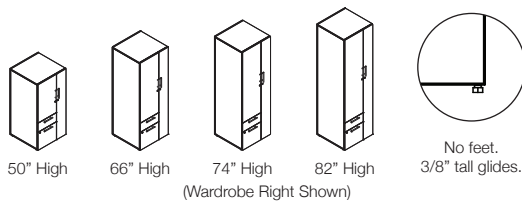

BF WARDROBE TOWERS WITH CUPBOARD ON FEET

H	W	D	Wardrobe Left	Wardrobe Right	List
			Model Number	Model Number	
50	24	24	C-WBFCDL50	C-WBFCDR50	3,803
66	24	24	C-WBFCDL66	C-WBFCDR66	4,174

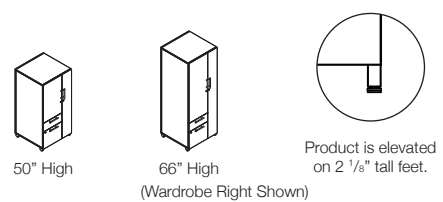

Specify

Notes

- Laminate Selection for Case
- Laminate Selection for Drawers/Doors/Face
- Handle Selection

- Right-handed wardrobes shown.

BBF Wardrobe Towers

BBF WARDROBE TOWERS WITH OPEN FRONT

H	W	D	Wardrobe Left	Wardrobe Right	List
			Model Number	Model Number	
50	24	24	X-WLBBFOF50	X-WRBBFOF50	3,776
66	24	24	X-WLBBFOF66	X-WRBBFOF66	4,086
74	24	24	X-WLBBFOF74	X-WRBBFOF74	4,212
82	24	24	X-WLBBFOF82	X-WRBBFOF82	4,408

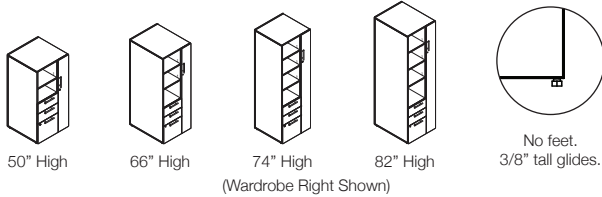

BBF WARDROBE TOWERS WITH OPEN FRONT ON FEET

H	W	D	Wardrobe Left	Wardrobe Right	List
			Model Number	Model Number	
50	24	24	C-WLBBFOF50	C-WRBBFOF50	3,844
66	24	24	C-WLBBFOF66	C-WRBBFOF66	4,156

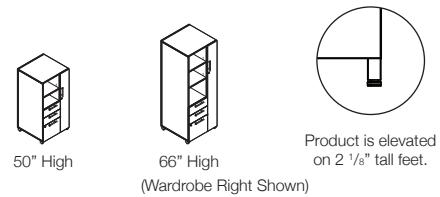

BBF WARDROBE TOWERS WITH OPEN SIDE

H	W	D	Wardrobe Left	Wardrobe Right	List
			Model Number	Model Number	
50	24	24	X-WLBBFOS50	X-WRBBFOS50	3,782
66	24	24	X-WLBBFOS66	X-WRBBFOS66	4,092
74	24	24	X-WLBBFOS74	X-WRBBFOS74	4,204
82	24	24	X-WLBBFOS82	X-WRBBFOS82	4,399

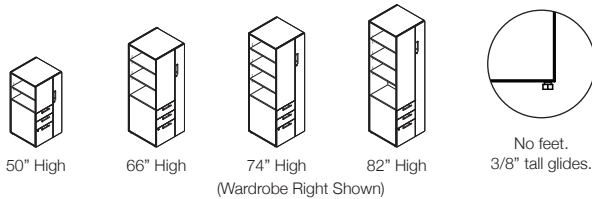

BBF WARDROBE TOWERS WITH OPEN SIDE ON FEET

H	W	D	Wardrobe Left	Wardrobe Right	List
			Model Number	Model Number	
50	24	24	C-WTBBBFL49	C-WTBBBFR49	3,853
66	24	24	C-WTBBBFL65	C-WTBBBFR65	4,161

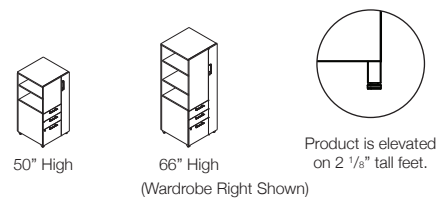

BBF WARDROBE TOWERS WITH CUPBOARD

H	W	D	Wardrobe Left	Wardrobe Right	List
			Model Number	Model Number	
50	24	24	X-WBBFCDL50	X-WBBFCDR50	3,894
66	24	24	X-WBBFCDL66	X-WBBFCDR66	4,257
74	24	24	X-WBBFCDL74	X-WBBFCDR74	4,401
82	24	24	X-WBBFCDL82	X-WBBFCDR82	4,632

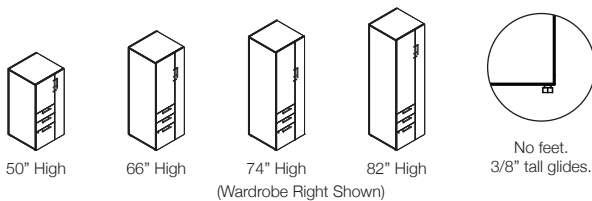

BBF WARDROBE TOWERS WITH CUPBOARD ON FEET

H	W	D	Wardrobe Left	Wardrobe Right	List
			Model Number	Model Number	
50	24	24	C-WTCBBFL49	C-WTCBBFR49	3,964
66	24	24	C-WTCBBFL65	C-WTCBBFR65	4,327

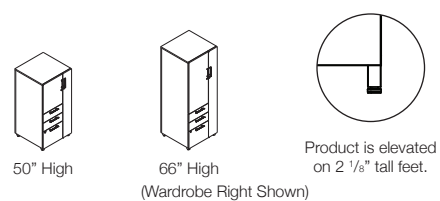

Specify

- Laminate Selection for Case
- Laminate Selection for Drawers/Doors/Face
- Handle Selection

Notes

- Right-handed wardrobes shown.

FF Wardrobe Towers

FF WARDROBE TOWERS WITH OPEN FRONT

H	W	D	Wardrobe Left	Wardrobe Right	List
			Model Number	Model Number	
50	24	24	X-WLFFOF50	X-WRFFOF50	3,678
66	24	24	X-WLFFOF66	X-WRFFOF66	3,985
74	24	24	X-WLFFOF74	X-WRFFOF74	4,109
82	24	24	X-WLFFOF82	X-WRFFOF82	4,298

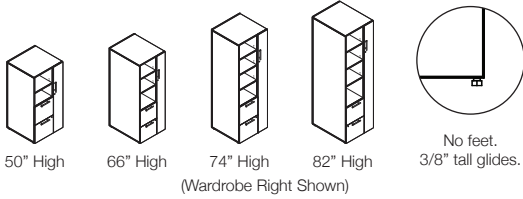

FF WARDROBE TOWERS WITH OPEN FRONT ON FEET

H	W	D	Wardrobe Left	Wardrobe Right	List
			Model Number	Model Number	
50	24	24	C-WLFFOF50	C-WRFFOF50	3,748
66	24	24	C-WLFFOF66	C-WRFFOF66	4,055

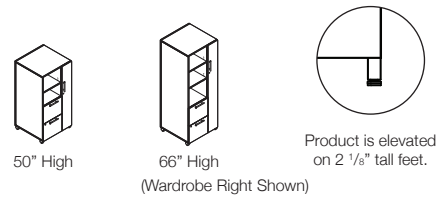

FF WARDROBE TOWERS WITH OPEN SIDE

H	W	D	Wardrobe Left	Wardrobe Right	List
			Model Number	Model Number	
50	24	24	X-WLFFOS50	X-WRFFOS50	3,676
66	24	24	X-WLFFOS66	X-WRFFOS66	3,978
74	24	24	X-WLFFOS74	X-WRFFOS74	4,092
82	24	24	X-WLFFOS82	X-WRFFOS82	4,281

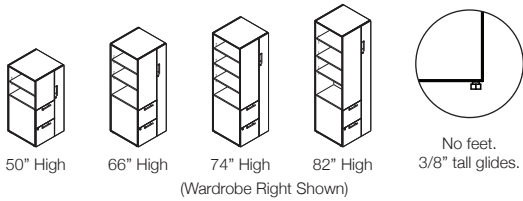

FF WARDROBE TOWERS WITH OPEN SIDE ON FEET

H	W	D	Wardrobe Left	Wardrobe Right	List
			Model Number	Model Number	
50	24	24	C-WTBFFL49	C-WTBFFR49	3,746
66	24	24	C-WTBFFL65	C-WTBFFR65	4,048

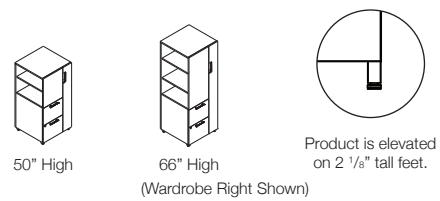

FF WARDROBE TOWERS WITH CUPBOARD

H	W	D	Wardrobe Left	Wardrobe Right	List
			Model Number	Model Number	
50	24	24	X-WFFCDL50	X-WFFCDR50	3,850
66	24	24	X-WFFCDL66	X-WFFCDR66	4,048
74	24	24	X-WFFCDL74	X-WFFCDR74	4,191
82	24	24	X-WFFCDL82	X-WFFCDR82	4,387

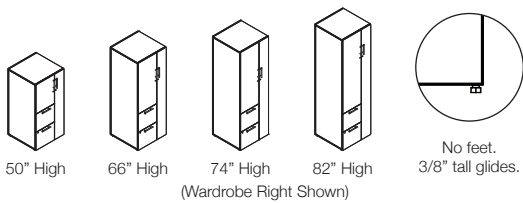

FF WARDROBE TOWERS WITH CUPBOARD ON FEET

H	W	D	Wardrobe Left	Wardrobe Right	List
			Model Number	Model Number	
50	24	24	C-WTCFFL49	C-WTCFFR49	3,920
66	24	24	C-WTCFFL65	C-WTCFFR65	4,117

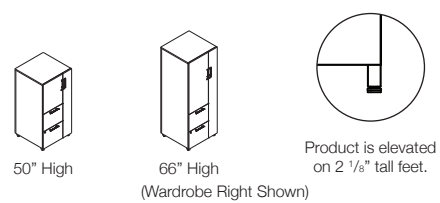

Specify

Notes

- Laminate Selection for Case
- Laminate Selection for Drawers/Doors/Face
- Handle Selection
- Right-handed wardrobes shown.

BF Pedestal Towers with Open Front

BF PEDESTAL TOWERS WITH OPEN FRONT

H	W	D	Model Number	List
50	12	24	X-PTBFOF5012	2,575
50	16	24	X-PTBFOF50	2,711
50	18	24	X-PTBFOF5018	2,847
50	24	24	X-PTBFOF5024	2,991
66	12	24	X-PTBFOF6612	2,760
66	16	24	X-PTBFOF66	2,904
66	18	24	X-PTBFOF6618	3,050
66	24	24	X-PTBFOF6624	3,204
74	12	24	X-PTBFOF7412	2,880
74	16	24	X-PTBFOF74	3,029
74	18	24	X-PTBFOF7418	3,182
74	24	24	X-PTBFOF7424	3,341
82	12	24	X-PTBFOF8212	2,945
82	16	24	X-PTBFOF82	3,098
82	18	24	X-PTBFOF8218	3,255
82	24	24	X-PTBFOF8224	3,418

BF PEDESTAL TOWERS WITH OPEN FRONT ON FEET

H	W	D	Model Number	List
50	12	24	C-PTBFOF5012	2,644
50	16	24	C-PTBFOF50	2,781
50	18	24	C-PTBFOF5018	2,921
50	24	24	C-PTBFOF5024	3,067
66	12	24	C-PTBFOF6612	2,826
66	16	24	C-PTBFOF66	2,975
66	18	24	C-PTBFOF6618	3,124
66	24	24	C-PTBFOF6624	3,280

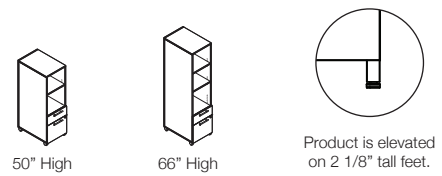
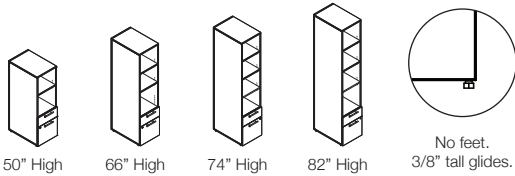

Specify

Notes

- Laminate Selection for Case
- Laminate Selection for Drawers/Doors/
Face
- Handle Selection

BF Pedestal Towers with Open Side

BF PEDESTAL TOWERS WITH OPEN SIDE					
H	W	D	Open Right, Place Left	Open Left, Place Right	List
			Model Number	Model Number	
50	12	24	X-PTBFOSL5012	X-PTBFOSR5012	2,580
50	16	24	X-PTBFOSL50	X-PTBFOSR50	2,715
50	18	24	X-PTBFOSL5018	X-PTBFOSR5018	2,852
50	24	24	X-PTBFOSL5024	X-PTBFOSR5024	2,994
66	12	24	X-PTBFOSL6612	X-PTBFOSR6612	2,759
66	16	24	X-PTBFOSL66	X-PTBFOSR66	2,902
66	18	24	X-PTBFOSL6618	X-PTBFOSR6618	3,048
66	24	24	X-PTBFOSL6624	X-PTBFOSR6624	3,203
74	12	24	X-PTBFOSL7412	X-PTBFOSR7412	2,819
74	16	24	X-PTBFOSL74	X-PTBFOSR74	2,966
74	18	24	X-PTBFOSL7418	X-PTBFOSR7418	3,116
74	24	24	X-PTBFOSL7424	X-PTBFOSR7424	3,274
82	12	24	X-PTBFOSL8212	X-PTBFOSR8212	2,932
82	16	24	X-PTBFOSL82	X-PTBFOSR82	3,086
82	18	24	X-PTBFOSL8218	X-PTBFOSR8218	3,240
82	24	24	X-PTBFOSL8224	X-PTBFOSR8224	3,404

BF PEDESTAL TOWERS WITH OPEN SIDE ON FEET					
H	W	D	Open Right, Place Left	Open Left, Place Right	List
			Model Number	Model Number	
50	12	24	C-PTBFOSL5012	C-PTBFOSR5012	2,645
50	16	24	C-PTBFOSL50	C-PTBFOSR50	2,784
50	18	24	C-PTBFOSL5018	C-PTBFOSR5018	2,923
50	24	24	C-PTBFOSL5024	C-PTBFOSR5024	3,071
66	12	24	C-PTBFOSL6612	C-PTBFOSR6612	2,824
66	16	24	C-PTBFOSL66	C-PTBFOSR66	2,973
66	18	24	C-PTBFOSL6618	C-PTBFOSR6618	3,122
66	24	24	C-PTBFOSL6624	C-PTBFOSR6624	3,278

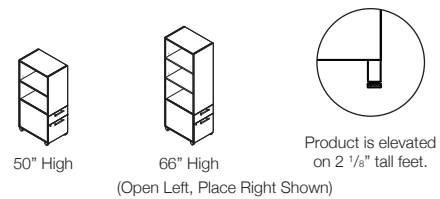
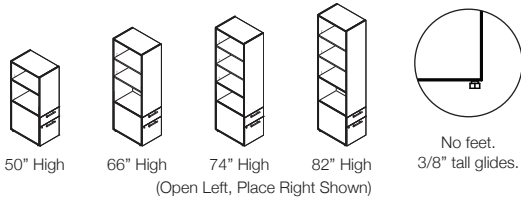

Specify

Notes

- Laminate Selection for Case
- Laminate Selection for Drawers/Doors/Face
- Handle Selection

BF Pedestal Towers with Cupboard

BF PEDESTAL TOWERS WITH CUPBOARD					
H	W	D	Left-Hinge	Right-Hinge	List
			Model Number	Model Number	
50	12	24	X-PTBFCL5012	X-PTBFCR5012	2,729
50	16	24	X-PTBFCL50	X-PTBFCR50	2,871
50	18	24	X-PTBFCL5018	X-PTBFCR5018	3,016
50	24	24	X-PTBFCL5024	X-PTBFCR5024	3,167
66	12	24	X-PTBFCL6612	X-PTBFCR6612	2,972
66	16	24	X-PTBFCL66	X-PTBFCR66	3,127
66	18	24	X-PTBFCL6618	X-PTBFCR6618	3,285
66	24	24	X-PTBFCL6624	X-PTBFCR6624	3,449
74	12	24	X-PTBFCL7412	X-PTBFCR7412	3,083
74	16	24	X-PTBFCL74	X-PTBFCR74	3,245
74	18	24	X-PTBFCL7418	X-PTBFCR7418	3,407
74	24	24	X-PTBFCL7424	X-PTBFCR7424	3,577
82	12	24	X-PTBFCL8212	X-PTBFCR8212	3,213
82	16	24	X-PTBFCL82	X-PTBFCR82	3,381
82	18	24	X-PTBFCL8218	X-PTBFCR8218	3,550
82	24	24	X-PTBFCL8224	X-PTBFCR8224	3,730

BF PEDESTAL TOWERS WITH CUPBOARD ON FEET					
H	W	D	Left-Hinge	Right-Hinge	List
			Model Number	Model Number	
50	12	24	C-PTBFCL5012	C-PTBFCR5012	2,793
50	16	24	C-PTBFCL50	C-PTBFCR50	2,941
50	18	24	C-PTBFCL5018	C-PTBFCR5018	3,087
50	24	24	C-PTBFCL5024	C-PTBFCR5024	3,243
66	12	24	C-PTBFCL6612	C-PTBFCR6612	3,039
66	16	24	C-PTBFCL66	C-PTBFCR66	3,197
66	18	24	C-PTBFCL6618	C-PTBFCR6618	3,357
66	24	24	C-PTBFCL6624	C-PTBFCR6624	3,527

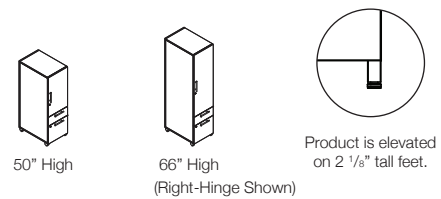
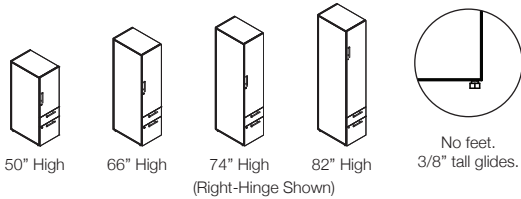

Specify

Notes

- Laminate Selection for Case
- Laminate Selection for Drawers/Doors/Face
- Handle Selection

BBF Pedestal Towers with Open Front

BBF PEDESTAL TOWERS WITH OPEN FRONT				
H	W	D	Model Number	List
50	12	24	X-PTBBFOF5012	2,748
50	16	24	X-PTBBFOF50	2,892
50	18	24	X-PTBBFOF5018	3,037
50	24	24	X-PTBBFOF5024	3,189
66	12	24	X-PTBBFOF6612	2,931
66	16	24	X-PTBBFOF66	3,084
66	18	24	X-PTBBFOF6618	3,239
66	24	24	X-PTBBFOF6624	3,401
74	12	24	X-PTBBFOF7412	2,999
74	16	24	X-PTBBFOF74	3,156
74	18	24	X-PTBBFOF7418	3,316
74	24	24	X-PTBBFOF7424	3,481
82	12	24	X-PTBBFOF8212	3,114
82	16	24	X-PTBBFOF82	3,278
82	18	24	X-PTBBFOF8218	3,441
82	24	24	X-PTBBFOF8224	3,615

BBF PEDESTAL TOWERS WITH OPEN FRONT ON FEET				
H	W	D	Model Number	List
50	12	24	C-PTBBFOF5012	2,814
50	16	24	C-PTBBFOF50	2,961
50	18	24	C-PTBBFOF5018	3,109
50	24	24	C-PTBBFOF5024	3,265
66	12	24	C-PTBBFOF6612	2,995
66	16	24	C-PTBBFOF66	3,153
66	18	24	C-PTBBFOF6618	3,313
66	24	24	C-PTBBFOF6624	3,478

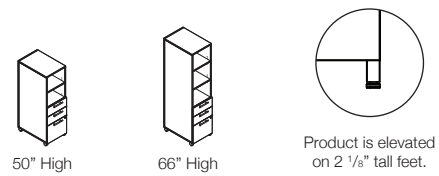
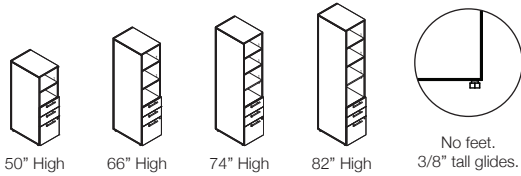

Specify

Notes

- Laminate Selection for Case
- Laminate Selection for Drawers/Doors/Face
- Handle Selection

BBF Pedestal Towers with Open Side

BBF PEDESTAL TOWERS WITH OPEN SIDE

H	W	D	Open Right, Place Left	Open Left, Place Right	List
			Model Number	Model Number	
50	12	24	X-PTBBFOSL5012	X-PTBBFOSR5012	2,746
50	16	24	X-PTBBFOSL50	X-PTBBFOSR50	2,891
50	18	24	X-PTBBFOSL5018	X-PTBBFOSR5018	3,036
50	24	24	X-PTBBFOSL5024	X-PTBBFOSR5024	3,188
66	12	24	X-PTBBFOSL6612	X-PTBBFOSR6612	2,925
66	16	24	X-PTBBFOSL66	X-PTBBFOSR66	3,078
66	18	24	X-PTBBFOSL6618	X-PTBBFOSR6618	3,235
66	24	24	X-PTBBFOSL6624	X-PTBBFOSR6624	3,397
74	12	24	X-PTBBFOSL7412	X-PTBBFOSR7412	2,990
74	16	24	X-PTBBFOSL74	X-PTBBFOSR74	3,145
74	18	24	X-PTBBFOSL7418	X-PTBBFOSR7418	3,303
74	24	24	X-PTBBFOSL7424	X-PTBBFOSR7424	3,468
82	12	24	X-PTBBFOSL8212	X-PTBBFOSR8212	3,102
82	16	24	X-PTBBFOSL82	X-PTBBFOSR82	3,263
82	18	24	X-PTBBFOSL8218	X-PTBBFOSR8218	3,428
82	24	24	X-PTBBFOSL8224	X-PTBBFOSR8224	3,599

BBF PEDESTAL TOWERS WITH OPEN SIDE ON FEET

H	W	D	Open Right, Place Left	Open Left, Place Right	List
			Model Number	Model Number	
50	12	24	C-PTBBFOSL5012	C-PTBBFOSR5012	2,813
50	16	24	C-PTBBFOSL50	C-PTBBFOSR50	2,960
50	18	24	C-PTBBFOSL5018	C-PTBBFOSR5018	3,108
50	24	24	C-PTBBFOSL5024	C-PTBBFOSR5024	3,263
66	12	24	C-PTBBFOSL6612	C-PTBBFOSR6612	2,991
66	16	24	C-PTBBFOSL66	C-PTBBFOSR66	3,148
66	18	24	C-PTBBFOSL6618	C-PTBBFOSR6618	3,305
66	24	24	C-PTBBFOSL6624	C-PTBBFOSR6624	3,472

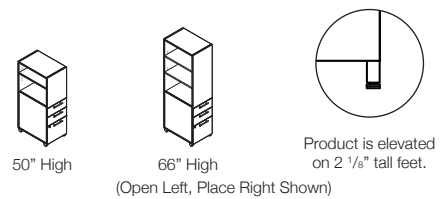
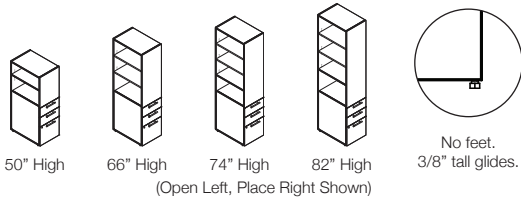

Specify

Notes

- Laminate Selection for Case
- Laminate Selection for Drawers/Doors/Face
- Handle Selection

BBF Pedestal Towers with Cupboard

BBF PEDESTAL TOWERS WITH CUPBOARD					
H	W	D	Left-Hinge	Right-Hinge	List
			Model Number	Model Number	
50	12	24	X-PTBBFCL5012	X-PTBBFCR5012	2,884
50	16	24	X-PTBBFCL50	X-PTBBFCR50	3,034
50	18	24	X-PTBBFCL5018	X-PTBBFCR5018	3,186
50	24	24	X-PTBBFCL5024	X-PTBBFCR5024	3,347
66	12	24	X-PTBBFCL6612	X-PTBBFCR6612	3,127
66	16	24	X-PTBBFCL66	X-PTBBFCR66	3,290
66	18	24	X-PTBBFCL6618	X-PTBBFCR6618	3,455
66	24	24	X-PTBBFCL6624	X-PTBBFCR6624	3,629
74	12	24	X-PTBBFCL7412	X-PTBBFCR7412	3,213
74	16	24	X-PTBBFCL74	X-PTBBFCR74	3,381
74	18	24	X-PTBBFCL7418	X-PTBBFCR7418	3,550
74	24	24	X-PTBBFCL7424	X-PTBBFCR7424	3,730
82	12	24	X-PTBBFCL8212	X-PTBBFCR8212	3,370
82	16	24	X-PTBBFCL82	X-PTBBFCR82	3,547
82	18	24	X-PTBBFCL8218	X-PTBBFCR8218	3,726
82	24	24	X-PTBBFCL8224	X-PTBBFCR8224	3,912

BBF PEDESTAL TOWERS WITH CUPBOARD ON FEET					
H	W	D	Left-Hinge	Right-Hinge	List
			Model Number	Model Number	
50	12	24	C-PTBBFCL5012	C-PTBBFCR5012	2,951
50	16	24	C-PTBBFCL50	C-PTBBFCR50	3,105
50	18	24	C-PTBBFCL5018	C-PTBBFCR5018	3,260
50	24	24	C-PTBBFCL5024	C-PTBBFCR5024	3,425
66	12	24	C-PTBBFCL6612	C-PTBBFCR6612	3,193
66	16	24	C-PTBBFCL66	C-PTBBFCR66	3,360
66	18	24	C-PTBBFCL6618	C-PTBBFCR6618	3,354
66	24	24	C-PTBBFCL6624	C-PTBBFCR6624	3,520

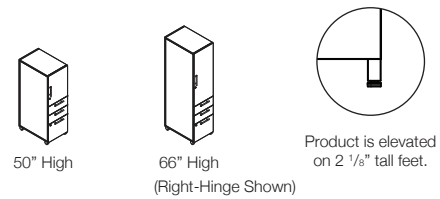
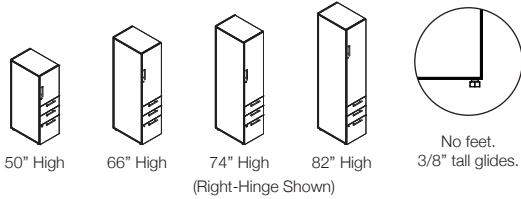

Specify

Notes

- Laminate Selection for Case
- Laminate Selection for Drawers/Doors/Face
- Handle Selection

FF Pedestal Towers with Open Front

FF PEDESTAL TOWERS WITH OPEN FRONT

H	W	D	Model Number	List
50	12	24	X-PTFFOF5012	2,672
50	16	24	X-PTFFOF50	2,814
50	18	24	X-PTFFOF5018	2,955
50	24	24	X-PTFFOF5024	3,104
66	12	24	X-PTFFOF6612	2,857
66	16	24	X-PTFFOF66	3,007
66	18	24	X-PTFFOF6618	3,157
66	24	24	X-PTFFOF6624	3,317
74	12	24	X-PTFFOF7412	2,926
74	16	24	X-PTFFOF74	3,081
74	18	24	X-PTFFOF7418	3,236
74	24	24	X-PTFFOF7424	3,398
82	12	24	X-PTFFOF8212	3,041
82	16	24	X-PTFFOF82	3,202
82	18	24	X-PTFFOF8218	3,359
82	24	24	X-PTFFOF8224	3,529

FF PEDESTAL TOWERS WITH OPEN FRONT ON FEET

H	W	D	Model Number	List
50	12	24	C-PTFFOF5012	2,739
50	16	24	C-PTFFOF50	2,883
50	18	24	C-PTFFOF5018	3,027
50	24	24	C-PTFFOF5024	3,179
66	12	24	C-PTFFOF6612	2,923
66	16	24	C-PTFFOF66	3,076
66	18	24	C-PTFFOF6618	3,230
66	24	24	C-PTFFOF6624	3,394

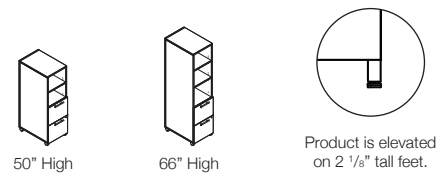
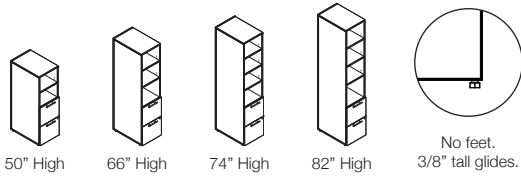

Specify

Notes

- Laminate Selection for Case
- Laminate Selection for Drawers/Doors/Face
- Handle Selection

FF Pedestal Towers with Open Side

FF PEDESTAL TOWERS WITH OPEN SIDE					
H	W	D	Open Right, Place Left	Open Left, Place Right	List
			Model Number	Model Number	
50	12	24	X-PTFFOSL5012	X-PTFFOSR5012	2,671
50	16	24	X-PTFFOSL50	X-PTFFOSR50	2,813
50	18	24	X-PTFFOSL5018	X-PTFFOSR5018	2,954
50	24	24	X-PTFFOSL5024	X-PTFFOSR5024	3,103
66	12	24	X-PTFFOSL6612	X-PTFFOSR6612	2,853
66	16	24	X-PTFFOSL66	X-PTFFOSR66	3,002
66	18	24	X-PTFFOSL6618	X-PTFFOSR6618	3,153
66	24	24	X-PTFFOSL6624	X-PTFFOSR6624	3,313
74	12	24	X-PTFFOSL7412	X-PTFFOSR7412	2,921
74	16	24	X-PTFFOSL74	X-PTFFOSR74	3,074
74	18	24	X-PTFFOSL7418	X-PTFFOSR7418	3,228
74	12	24	X-PTFFOSL7424	X-PTFFOSR7424	3,391
82	12	24	X-PTFFOSL8212	X-PTFFOSR8212	3,033
82	16	24	X-PTFFOSL82	X-PTFFOSR82	3,192
82	18	24	X-PTFFOSL8218	X-PTFFOSR8218	3,353
82	24	24	X-PTFFOSL8224	X-PTFFOSR8224	3,519

FF PEDESTAL TOWERS WITH OPEN SIDE ON FEET					
H	W	D	Open Right, Place Left	Open Left, Place Right	List
			Model Number	Model Number	
50	12	24	C-PTFFOSL5012	C-PTFFOSR5012	2,738
50	16	24	C-PTFFOSL50	C-PTFFOSR50	2,882
50	18	24	C-PTFFOSL5018	C-PTFFOSR5018	3,026
50	24	24	C-PTFFOSL5024	C-PTFFOSR5024	3,178
66	12	24	C-PTFFOSL6612	C-PTFFOSR6612	2,918
66	16	24	C-PTFFOSL66	C-PTFFOSR66	3,072
66	18	24	C-PTFFOSL6618	C-PTFFOSR6618	3,225
66	24	24	C-PTFFOSL6624	C-PTFFOSR6624	3,387

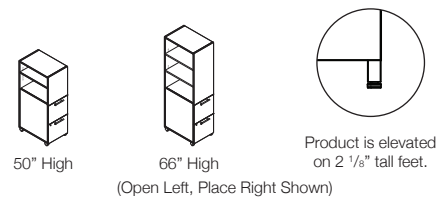
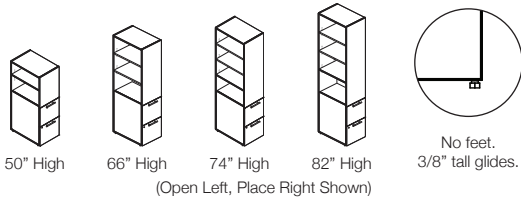

Specify

Notes

- Laminate Selection for Case
- Laminate Selection for Drawers/Doors/Face
- Handle Selection

FF Pedestal Towers with Cupboard

FF PEDESTAL TOWERS WITH CUPBOARD					
H	W	D	Left-Hinge	Right-Hinge	List
			Model Number	Model Number	
50	12	24	X-PTFFCL5012	X-PTFFCR5012	2,754
50	16	24	X-PTFFCL50	X-PTFFCR50	2,897
50	18	24	X-PTFFCL5018	X-PTFFCR5018	3,044
50	24	24	X-PTFFCL5024	X-PTFFCR5024	3,195
66	12	24	X-PTFFCL6612	X-PTFFCR6612	2,958
66	16	24	X-PTFFCL66	X-PTFFCR66	3,113
66	18	24	X-PTFFCL6618	X-PTFFCR6618	3,269
66	24	24	X-PTFFCL6624	X-PTFFCR6624	3,434
74	12	24	X-PTFFCL7412	X-PTFFCR7412	3,028
74	16	24	X-PTFFCL74	X-PTFFCR74	3,186
74	18	24	X-PTFFCL7418	X-PTFFCR7418	3,347
74	24	24	X-PTFFCL7424	X-PTFFCR7424	3,515
82	12	24	X-PTFFCL8212	X-PTFFCR8212	3,165
82	16	24	X-PTFFCL82	X-PTFFCR82	3,331
82	18	24	X-PTFFCL8218	X-PTFFCR8218	3,500
82	24	24	X-PTFFCL8224	X-PTFFCR8224	3,674

FF PEDESTAL TOWERS WITH CUPBOARD ON FEET					
H	W	D	Left-Hinge	Right-Hinge	List
			Model Number	Model Number	
50	12	24	C-PTFFCL5012	C-PTFFCR5012	2,820
50	16	24	C-PTFFCL50	C-PTFFCR50	2,967
50	18	24	C-PTFFCL5018	C-PTFFCR5018	3,117
50	24	24	C-PTFFCL5024	C-PTFFCR5024	3,275
66	12	24	C-PTFFCL6612	C-PTFFCR6612	3,024
66	16	24	C-PTFFCL66	C-PTFFCR66	3,183
66	18	24	C-PTFFCL6618	C-PTFFCR6618	3,343
66	24	24	C-PTFFCL6624	C-PTFFCR6624	3,510

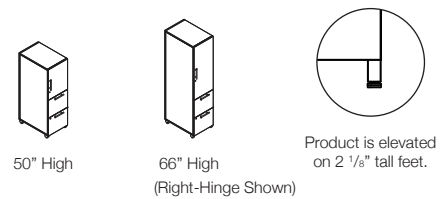
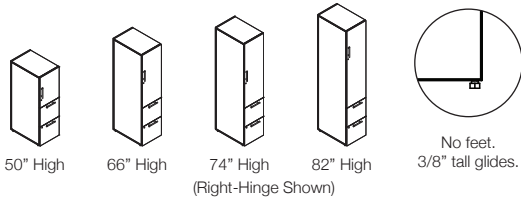

Specify

Notes

- Laminate Selection for Case
- Laminate Selection for Drawers/Doors/Face
- Handle Selection

BF Lateral Bookcases

BF LATERAL BOOKCASES				
H	W	D	Model Number	List
66	30	18	X-BFLBC663018	3,398
66	30	24	X-BFLBC663024	3,734
66	36	18	X-BFLBC663618	3,582
66	36	24	X-BFLBC663624	3,951
74	30	18	X-BFLBC743018	3,546
74	30	24	X-BFLBC743024	3,918
74	36	18	X-BFLBC743618	3,750
74	36	24	X-BFLBC743624	4,157
82	30	18	X-BFLBC823018	3,618
82	30	24	X-BFLBC823024	4,002
82	36	18	X-BFLBC823618	3,829
82	36	24	X-BFLBC823624	4,250

BF LATERAL BOOKCASES ON FEET				
H	W	D	Model Number	List
66	30	18	C-BFLBC663018	3,468
66	30	24	C-BFLBC663024	3,803
66	36	18	C-BFLBC663618	3,650
66	36	24	C-BFLBC663624	4,020

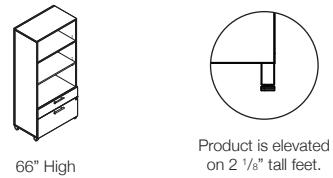
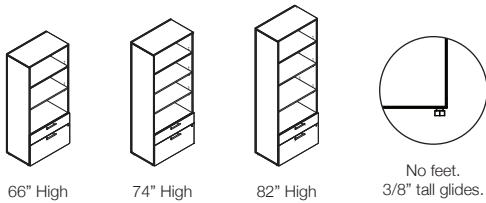

Specify

Notes

- Laminate Selection for Case
- Laminate Selection for Drawers/Face
- Handle Selection

BF Laterals with Cabinet Doors

BF LATERALS WITH CABINET DOORS

H	W	D	Model Number	List
66	30	18	X-BFLCD663018	3,855
66	30	24	X-BFLCD663024	4,190
66	36	18	X-BFLCD663618	4,073
66	36	24	X-BFLCD663624	4,443
74	30	18	X-BFLCD743018	4,016
74	30	24	X-BFLCD743024	4,364
74	36	18	X-BFLCD743618	4,250
74	36	24	X-BFLCD743624	4,628
82	30	18	X-BFLCD823018	4,192
82	30	24	X-BFLCD823024	4,576
82	36	18	X-BFLCD823618	4,450
82	36	24	X-BFLCD823624	4,872

BF LATERALS WITH CABINET DOORS ON FEET

H	W	D	Model Number	List
66	30	18	C-BFLCD663018	3,925
66	30	24	C-BFLCD663024	4,260
66	36	18	C-BFLCD663618	4,143
66	36	24	C-BFLCD663624	4,513

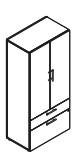

66" High

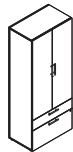

74" High



82" High

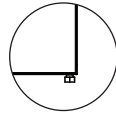

No feet.
3/8" tall glides.

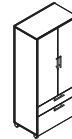

66" High

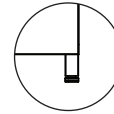

Product is elevated
on 2 1/8" tall feet.

Specify

Notes

- Laminate Selection for Case
- Laminate Selection for Drawers/Doors/
Face
- Handle Selection

BBF Lateral Bookcases

BBF LATERAL BOOKCASES				
H	W	D	Model Number	List
66	30	18	X-BBFLBC663018	3,699
66	30	24	X-BBFLBC663024	4,021
66	36	18	X-BBFLBC663618	3,901
66	36	24	X-BBFLBC663624	4,260
74	30	18	X-BBFLBC743018	3,792
74	30	24	X-BBFLBC743024	4,185
74	36	18	X-BBFLBC743618	4,004
74	36	24	X-BBFLBC743624	4,433
82	30	18	X-BBFLBC823018	3,936
82	30	24	X-BBFLBC823024	4,365
82	36	18	X-BBFLBC823618	4,167
82	36	24	X-BBFLBC823624	4,637

BBF LATERAL BOOKCASES ON FEET				
H	W	D	Model Number	List
66	30	18	C-BBFLBC663018	3,769
66	30	24	C-BBFLBC663024	4,092
66	36	18	C-BBFLBC663618	3,972
66	36	24	C-BBFLBC663624	4,329

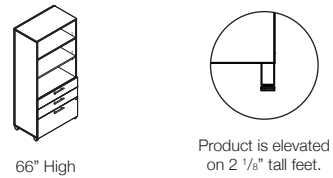
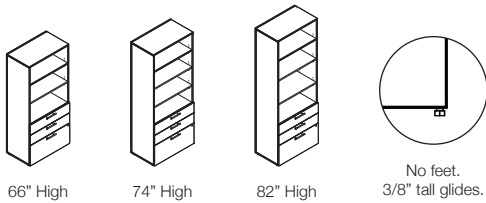

Specify

Notes

- Laminate Selection for Case
- Laminate Selection for Drawers/Face
- Handle Selection

BBF Lateral Bookcases with Divider

BBF LATERAL BOOKCASES WITH DIVIDER

H	W	D	Model Number	List
42	30	18	X-BBFLBC423018D	3,445
42	36	18	X-BBFLBC423618D	3,612
42	42	18	X-BBFLBC424218D	3,778
50	30	18	X-BBFLBC503018D	3,545
50	36	18	X-BBFLBC503618D	3,720
50	42	18	X-BBFLBC504218D	3,891
66	30	18	X-BBFLBC663018D	3,641
66	36	18	X-BBFLBC663618D	3,829
66	42	18	X-BBFLBC664218D	4,002
74	30	18	X-BBFLBC743018D	3,742
74	36	18	X-BBFLBC743618D	3,935
74	42	18	X-BBFLBC744218D	4,113
82	30	18	X-BBFLBC823018D	3,841
82	36	18	X-BBFLBC823618D	4,043
82	42	18	X-BBFLBC824218D	4,224

BBF LATERAL BOOKCASES WITH DIVIDER ON FEET

H	W	D	Model Number	List
66	30	18	C-BBFLBC663018D	3,711
66	36	18	C-BBFLBC663618D	3,898
66	42	18	C-BBFLBC664218D	4,071

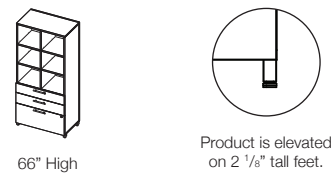
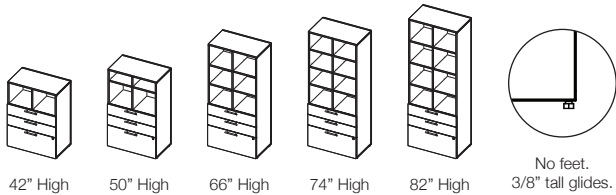

Specify **Notes**

- Laminate Selection for Case
- Laminate Selection for Drawers/Face
- Handle Selection

BBF Laterals with Cabinet Doors

BBF LATERALS WITH CABINET DOORS

H	W	D	Model Number	List
66	30	18	X-BBFLCD663018	4,161
66	30	24	X-BBFLCD663024	4,543
66	36	18	X-BBFLCD663618	4,398
66	36	24	X-BBFLCD663624	4,815
74	30	18	X-BBFLCD743018	4,274
74	30	24	X-BBFLCD743024	4,666
74	36	18	X-BBFLCD743618	4,524
74	36	24	X-BBFLCD743624	4,951
82	30	18	X-BBFLCD823018	4,502
82	30	24	X-BBFLCD823024	4,932
82	36	18	X-BBFLCD823618	4,779
82	36	24	X-BBFLCD823624	5,248

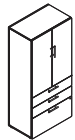

66" High

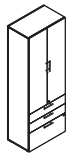

74" High

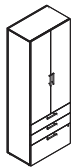

82" High

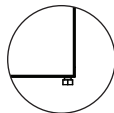

No feet.
3/8" tall glides.

BBF LATERALS WITH CABINET DOORS ON FEET

H	W	D	Model Number	List
66	30	18	C-BBFLCD663018	4,230
66	30	24	C-BBFLCD663024	4,611
66	36	18	C-BBFLCD663618	4,467
66	36	24	C-BBFLCD663624	4,883

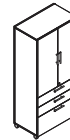

66" High

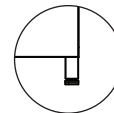

Product is elevated
on 2 1/8" tall feet.

Specify

Notes

- Laminate Selection for Case
- Laminate Selection for Drawers/Doors/Face
- Handle Selection

FF Lateral Bookcases

FF LATERAL BOOKCASE

H	W	D	Model Number	List
66	30	18	X-FFLBC663018	3,529
66	30	24	X-FFLBC663024	3,880
66	36	18	X-FFLBC663618	3,734
66	36	24	X-FFLBC663624	4,115
74	30	18	X-FFLBC743018	3,603
74	30	24	X-FFLBC743024	3,968
74	36	18	X-FFLBC743618	3,814
74	36	24	X-FFLBC743624	4,208
82	30	18	X-FFLBC823018	3,749
82	30	24	X-FFLBC823024	4,148
82	36	18	X-FFLBC823618	3,979
82	36	24	X-FFLBC823624	4,416

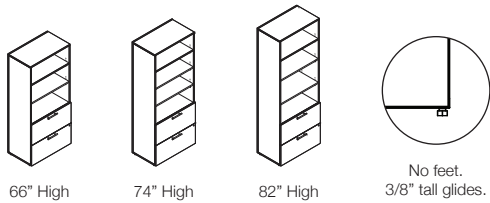

FF LATERAL BOOKCASE ON FEET

H	W	D	Model Number	List
66	30	18	C-FFLBC663018	3,599
66	30	24	C-FFLBC663024	3,951
66	36	18	C-FFLBC663618	3,803
66	36	24	C-FFLBC663624	4,185

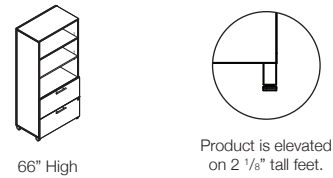

Specify

Notes

- Laminate Selection for Case
- Laminate Selection for Drawers/Face
- Handle Selection

FF Lateral Bookcases with Divider

FF LATERAL BOOKCASE WITH DIVIDER

H	W	D	Model Number	List
66	30	18	X-LATBC6630	3,475
66	36	18	X-LATBC6636	3,661
66	42	18	X-LATBC6642	3,832
74	30	18	X-LATBC7430	3,572
74	36	18	X-LATBC7436	3,768
74	42	18	X-LATBC7442	3,944
82	30	18	X-LATBC8230	3,671
82	36	18	X-LATBC8236	3,873
82	42	18	X-LATBC8242	4,056

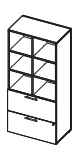

66" High

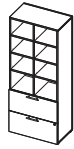

74" High



82" High

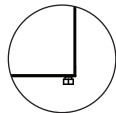

No feet.
3/8" tall glides.

FF LATERAL BOOKCASE WITH DIVIDER ON FEET

H	W	D	Model Number	List
66	30	18	C-LATBC6630	3,545
66	36	18	C-LATBC6636	3,730
66	42	18	C-LATBC6642	3,901

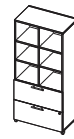

66" High

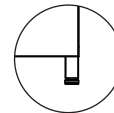

Product is elevated
on 2 1/8" tall feet.

Specify

Notes

- Laminate Selection for Case
- Laminate Selection for Drawers/Face
- Handle Selection

FF Laterals with Cabinet Doors

FF LATERAL WITH CABINET DOORS

H	W	D	Model Number	List
66	30	18	X-FFLCD663018	3,968
66	30	24	X-FFLCD663024	4,320
66	36	18	X-FFLCD663618	4,203
66	36	24	X-FFLCD663624	4,586
74	30	18	X-FFLCD743018	4,081
74	30	24	X-FFLCD743024	4,445
74	36	18	X-FFLCD743618	4,327
74	36	24	X-FFLCD743624	4,721
82	30	18	X-FFLCD823018	4,304
82	30	24	X-FFLCD823024	4,707
82	36	18	X-FFLCD823618	4,580
82	36	24	X-FFLCD823624	5,014

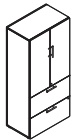

66" High

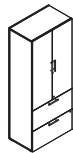

74" High

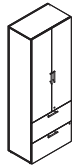

82" High

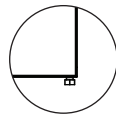

No feet.
3/8" tall glides.

FF LATERAL WITH CABINET DOORS ON FEET

H	W	D	Model Number	List
66	30	18	C-FFLCD663018	4,036
66	30	24	C-FFLCD663024	4,390
66	36	18	C-FFLCD663618	4,272
66	36	24	C-FFLCD663624	4,654

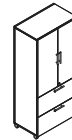

66" High

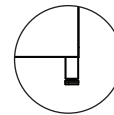

Product is elevated
on 2 1/8" tall feet.

Specify

Notes

- Laminate Selection for Case
- Laminate Selection for Drawers/Doors/
Face
- Handle Selection

66", 74" and 82" High Two Door Cabinets

TWO DOOR CABINETS				
H	W	D	Model Number	List
66	30	18	X-CBC663018	2,871
66	30	24	X-CBC663024	3,098
66	30	30	X-CBC663030	3,334
66	36	18	X-CBC663618	3,048
66	36	24	X-CBC663624	3,298
66	36	30	X-CBC663630	3,559
74	30	18	X-CBC743018	3,111
74	30	24	X-CBC743024	3,351
74	30	30	X-CBC743030	3,600
74	36	18	X-CBC743618	3,300
74	36	24	X-CBC743624	3,564
74	36	30	X-CBC743630	3,837
82	30	18	X-CBC823018	3,269
82	30	24	X-CBC823024	3,520
82	30	30	X-CBC823030	3,782
82	36	18	X-CBC823618	3,472
82	36	24	X-CBC823624	3,747
82	36	30	X-CBC823630	4,033

TWO DOOR CABINETS ON FEET				
H	W	D	Model Number	List
66	30	18	C-CBC663018	2,941
66	30	24	C-CBC663024	3,169
66	30	30	C-CBC663030	3,405
66	36	18	C-CBC663618	3,117
66	36	24	C-CBC663624	3,368
66	36	30	C-CBC663630	3,629

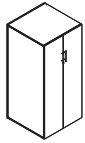

66" High

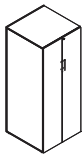

74" High

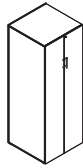

82" High

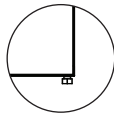

No feet.
3/8" tall glides.

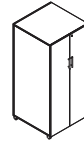

66" High

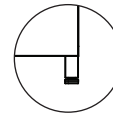

Product is elevated
on 2 1/8" tall feet.

Specify

- Laminate Selection for Case
- Laminate Selection for Doors/Face
- Handle Selection

Notes

- 66" high units include 3 adjustable shelves; 74" and 82" high units include 4 adjustable shelves.

Bookcases

BOOKCASES				
H	W	D	Model Number	List
42	30	14	X-BC423015	1,734
42	36	14	X-BC423615	1,811
50	30	14	X-BC503015	1,803
50	36	14	X-BC503615	1,885
66	30	14	X-BC663015	1,989
66	36	14	X-BC663615	2,098
74	30	14	X-BC743015	2,058
74	36	14	X-BC743615	2,171

BOOKCASES ON FEET				
H	W	D	Model Number	List
42	30	14	C-BC423015	1,803
42	36	14	C-BC423615	1,879
50	30	14	C-BC503015	1,873
50	36	14	C-BC503615	1,955
66	30	14	C-BC663015	2,060
66	36	14	C-BC663615	2,168

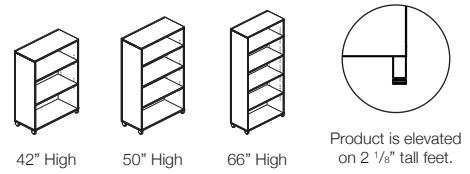
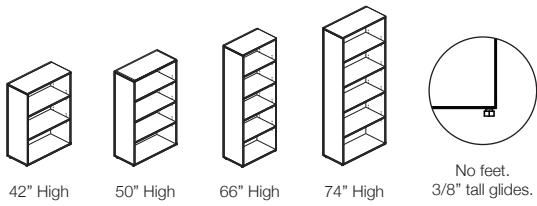

Specify

Notes

- Laminate Selection for Unit

Single Door Towers

SINGLE DOOR TOWERS					
H	W	D	Left-Hinge	Right-Hinge	List
			Model Number	Model Number	
42	12	18	X-SDCL4218	X-SDCR4218	2,094
42	12	24	X-SDCL4224	X-SDCR4224	2,182
42	12	30	X-SDCL4230	X-SDCR4230	2,277
42	12	36	X-SDCL4236	X-SDCR4236	2,367
50	12	18	X-SDCL5018	X-SDCR5018	2,168
50	12	24	X-SDCL5024	X-SDCR5024	2,272
50	12	30	X-SDCL5030	X-SDCR5030	2,375
50	12	36	X-SDCL5036	X-SDCR5036	2,480
58	12	18	X-SDCL5818	X-SDCR5818	2,389
58	12	24	X-SDCL5824	X-SDCR5824	2,506
58	12	30	X-SDCL5830	X-SDCR5830	2,623
58	12	36	X-SDCL5836	X-SDCR5836	2,739
66	12	18	X-SDCL6618	X-SDCR6618	2,459
66	12	24	X-SDCL6624	X-SDCR6624	2,589
66	12	30	X-SDCL6630	X-SDCR6630	2,719
66	12	36	X-SDCL6636	X-SDCR6636	2,846
74	12	18	X-SDCL7418	X-SDCR7418	2,530
74	12	24	X-SDCL7424	X-SDCR7424	2,671
74	12	30	X-SDCL7430	X-SDCR7430	2,815
74	12	36	X-SDCL7436	X-SDCR7436	2,956

SINGLE DOOR TOWERS ON FEET					
H	W	D	Left-Hinge	Right-Hinge	List
			Model Number	Model Number	
42	12	18	C-SDC421218RL	C-SDC421218LL	2,162
42	12	24	C-SDC421224RL	C-SDC421224LL	2,254
42	12	30	C-SDC421230RL	C-SDC421230LL	2,345
42	12	36	C-SDC421236RL	C-SDC421236LL	2,437
50	12	18	C-SDC501218RL	C-SDC501218LL	2,238
50	12	24	C-SDC501224RL	C-SDC501224LL	2,340
50	12	30	C-SDC501230RL	C-SDC501230LL	2,446
50	12	36	C-SDC501236RL	C-SDC501236LL	2,551
58	12	18	C-SDC581218RL	C-SDC581218LL	2,457
58	12	24	C-SDC581224RL	C-SDC581224LL	2,574
58	12	30	C-SDC581230RL	C-SDC581230LL	2,692
58	12	36	C-SDC581236RL	C-SDC581236LL	2,811
66	12	18	C-SDC661218RL	C-SDC661218LL	2,529
66	12	24	C-SDC661224RL	C-SDC661224LL	2,659
66	12	30	C-SDC661230RL	C-SDC661230LL	2,789
66	12	36	C-SDC661236RL	C-SDC661236LL	2,916

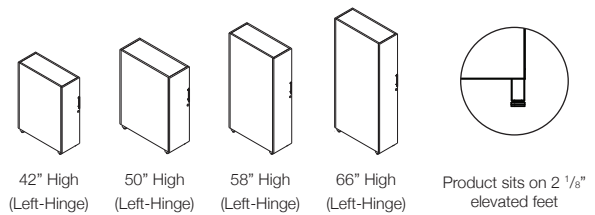
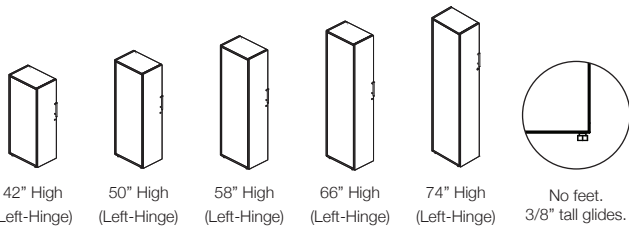

Specify

- Laminate Selection for Case
- Laminate Selection for Door/Face
- Handle Selection

Notes

- Left-hinge towers shown.
- Towers must be ganged together with another unit or secured to a wall.
- Towers are wardrobe style and do not have shelving.
- 18" deep units come equipped with a coat hook. 24", 30" and 36" deep units come equipped with a coat rod.
- Single door tower handles are designed to be aligned with adjacent storage elements in private office settings.
- Select sizes available on quick ship Calibrate Countdown program. See [Calibrate Countdown price list](#) for full details.

Lockers

SINGLE DOOR LOCKER

H	W	D	Left-Hinge	Right-Hinge	List
			Model Number	Model Number	
42	12	18	X-LSD421218L	X-LSD421218R	2,131
42	12	24	X-LSD421224L	X-LSD421224R	2,298
50	12	18	X-LSD501218L	X-LSD501218R	2,245
50	12	24	X-LSD501224L	X-LSD501224R	2,388
66	12	18	X-LSD661218L	X-LSD661218R	2,536
66	12	24	X-LSD661224L	X-LSD661224R	2,703
74	12	18	X-LSD741218L	X-LSD741218R	2,605
74	12	24	X-LSD741224L	X-LSD741224R	2,786

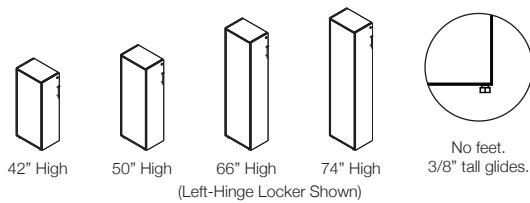

SINGLE DOOR LOCKER ON FEET

H	W	D	Left-Hinge	Right-Hinge	List
			Model Number	Model Number	
42	12	18	C-LSD421218L	C-LSD421218R	2,239
42	12	24	C-LSD421224L	C-LSD421224R	2,368
50	12	18	C-LSD501218L	C-LSD501218R	2,315
50	12	24	C-LSD501224L	C-LSD501224R	2,456
66	12	18	C-LSD661218L	C-LSD661218R	2,604
66	12	24	C-LSD661224L	C-LSD661224R	2,773

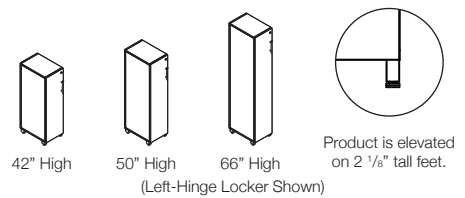

DOUBLE DOOR LOCKER

H	W	D	Left-Hinge	Right-Hinge	List
			Model Number	Model Number	
42	12	18	X-LDD421218L	X-LDD421218R	2,249
42	12	24	X-LDD421224L	X-LDD421224R	2,440
50	12	18	X-LDD501218L	X-LDD501218R	2,362
50	12	24	X-LDD501224L	X-LDD501224R	2,529

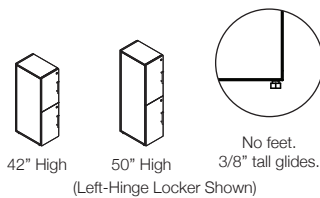

DOUBLE DOOR LOCKER ON FEET

H	W	D	Left-Hinge	Right-Hinge	List
			Model Number	Model Number	
42	12	18	C-LDD421218L	C-LDD421218R	2,358
42	12	24	C-LDD421224L	C-LDD421224R	2,510
50	12	18	C-LDD501218L	C-LDD501218R	2,433
50	12	24	C-LDD501224L	C-LDD501224R	2,598

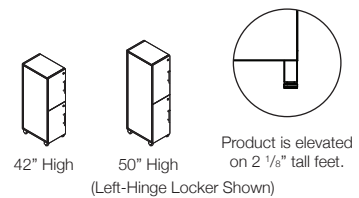

Specify

- Laminate Selection for Case
- Laminate Selection for Door/Face
- Handle Selection

Notes

- All lockers have coat hooks on the door side.
- 24" Deep Single Door units also come with a coat rod.
- All lockers have an adjustable shelf that is recessed by 6".
- Locks located at top of door.
- Lockers are compatible with digital locks (sold separately). Digital locks require field pre-drilling and installation. Template for pre-drilling is provided with locks.

Lockers

DOUBLE DOOR LOCKERS WITH OPPOSITE DOORS

H	W	D	Top Left-Hinge, Bottom Right-Hinge	Top Right-Hinge, Bottom Left-Hinge	List
			Model Number	Model Number	
42	12	18	X-DDLTL421218	X-DDLTR421218	2,278
42	12	24	X-DDLTL421224	X-DDLTR421224	2,469
50	12	18	X-DDLTL501218	X-DDLTR501218	2,392
50	12	24	X-DDLTL501224	X-DDLTR501224	2,557

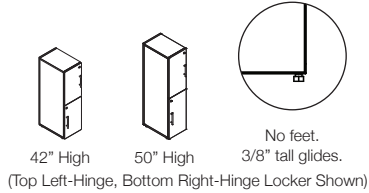

DOUBLE DOOR LOCKERS WITH OPPOSITE DOORS ON FEET

H	W	D	Top Left-Hinge, Bottom Right-Hinge	Top Right-Hinge, Bottom Left-Hinge	List
			Model Number	Model Number	
42	12	18	C-DDLTL421218	C-DDLTR421218	2,385
42	12	24	C-DDLTL421224	C-DDLTR421224	2,538
50	12	18	C-DDLTL501218	C-DDLTR501218	2,461
50	12	24	C-DDLTL501224	C-DDLTR501224	2,627

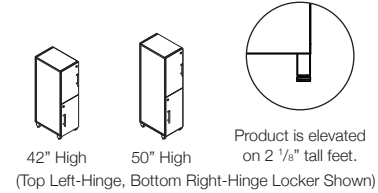

TRIPLE DOOR LOCKER

H	W	D	Left-Hinge	Right-Hinge	List
			Model Number	Model Number	
66	12	18	X-LTD661218L	X-LTD661218R	2,775
66	12	24	X-LTD661224L	X-LTD661224R	2,995
74	12	18	X-LTD741218L	X-LTD741218R	2,845
74	12	24	X-LTD741224L	X-LTD741224R	3,081

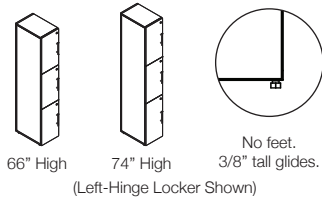

TRIPLE DOOR LOCKER ON FEET

H	W	D	Left-Hinge	Right-Hinge	List
			Model Number	Model Number	
66	12	18	C-LTD661218L	C-LTD661218R	2,844
66	12	24	C-LTD661224L	C-LTD661224R	3,066

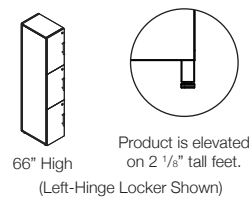

Specify

- Laminate Selection for Case
- Laminate Selection for Door/Face
- Handle Selection

Notes

- All lockers have coat hooks on the door side.
- All lockers have an adjustable shelf that is recessed by 6".
- Lockers are compatible with digital locks (sold separately). Digital locks require field pre-drilling and installation. Template for pre-drilling is provided with locks.

Calibrate Dry Planters

DRY PLANTERS				
H	W	D	Model Number	List
34	30	12	X-CP343012	1,450
34	36	12	X-CP343612	1,552
34	42	12	X-CP344212	1,653
34	48	12	X-CP344812	1,755
34	54	12	X-CP345412	1,856
34	60	12	X-CP346012	1,958
34	30	18	X-CP343018	1,595
34	36	18	X-CP343618	1,697
34	42	18	X-CP344218	1,798
34	48	18	X-CP344818	1,900
34	54	18	X-CP345418	2,001
34	60	18	X-CP346018	2,103
34	30	24	X-CP343024	1,755
34	36	24	X-CP343624	1,856
34	42	24	X-CP344224	1,958
34	48	24	X-CP344824	2,059
34	54	24	X-CP345424	2,161
34	60	24	X-CP346024	2,262

DRY PLANTERS				
H	W	D	Model Number	List
42	30	12	X-CP423012	1,668
42	36	12	X-CP423612	1,769
42	42	12	X-CP424212	1,871
42	48	12	X-CP424812	1,972
42	54	12	X-CP425412	2,074
42	60	12	X-CP426012	2,175
42	30	18	X-CP423018	1,834
42	36	18	X-CP423618	1,936
42	42	18	X-CP424218	2,037
42	48	18	X-CP424818	2,139
42	54	18	X-CP425418	2,240
42	60	18	X-CP426018	2,342
42	30	24	X-CP423024	2,018
42	36	24	X-CP423624	2,119
42	42	24	X-CP424224	2,221
42	48	24	X-CP424824	2,322
42	54	24	X-CP425424	2,424
42	60	24	X-CP426024	2,525

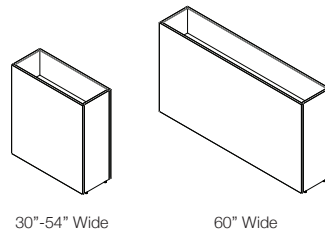

Specify

Notes

- Laminate Selection with Matching Edge
- 3/4" material thickness.
- Planter box depth is 9".
- Only for use with artificial plants.
- Not intended for use with water or soil.
- 12"D units must be ganged to another unit or wall for support.
- Grain runs vertical on 30"-50" wide units; grain runs vertical for sides and horizontal for front and back on 60" wide units.
- 3/8" tall glides.
- Ships assembled.
- Weight capacity: 18 lbs per linear foot.

Calibrate Dry Planters

DRY PLANTERS				
H	W	D	Model Number	List
50	30	12	X-CP503012	1,918
50	36	12	X-CP503612	2,019
50	42	12	X-CP504212	2,121
50	48	12	X-CP504812	2,222
50	54	12	X-CP505412	2,324
50	60	12	X-CP506012	2,425
50	30	18	X-CP503018	2,109
50	36	18	X-CP503618	2,211
50	42	18	X-CP504218	2,312
50	48	18	X-CP504818	2,414
50	54	18	X-CP505418	2,515
50	60	18	X-CP506018	2,617
50	30	24	X-CP503024	2,320
50	36	24	X-CP503624	2,422
50	42	24	X-CP504224	2,523
50	48	24	X-CP504824	2,625
50	54	24	X-CP505424	2,726
50	60	24	X-CP506024	2,828

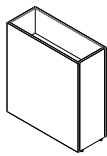

30"-54" Wide

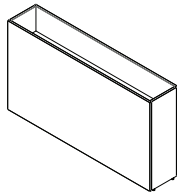

60" Wide

Specify

• Laminate Selection with Matching Edge

Notes

- 3/4" material thickness.
- Planter box depth is 9".
- Only for use with artificial plants.
- Not intended for use with water or soil.
- 12"D units must be ganged to another unit or wall for support.
- Grain runs vertical on 30"-50" wide units; grain runs vertical for sides and horizontal for front and back on 60" wide units.
- 3/8" tall glides.
- Ships assembled.
- Weight capacity: 18 lbs per linear foot.

Calibrate Stack-On Dry Planters

STACK-ON DRY PLANTERS

H	W	D	Model Number	List
8	30	12	X-CPSO083012	950
8	36	12	X-CPSO083612	979
8	42	12	X-CPSO084212	1,007
8	48	12	X-CPSO084812	1,036
8	54	12	X-CPSO085412	1,064
8	60	12	X-CPSO086012	1,093
8	30	18	X-CPSO083018	998
8	36	18	X-CPSO083618	1,026
8	42	18	X-CPSO084218	1,055
8	48	18	X-CPSO084818	1,083
8	54	18	X-CPSO085418	1,112
8	60	18	X-CPSO086018	1,140
8	30	24	X-CPSO083024	1,047
8	36	24	X-CPSO083624	1,076
8	42	24	X-CPSO084224	1,104
8	48	24	X-CPSO084824	1,133
8	54	24	X-CPSO085424	1,161
8	60	24	X-CPSO086024	1,190

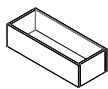

30"-54" Wide

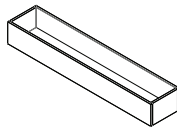

60" Wide

Specify

Notes

- Laminate Selection with Matching Edge
- 3/4" Material Thickness.
- Planter box depth is 7.25".
- Only for use with artificial plants.
- Not intended for use with water or soil.
- For use with Calibrate storage only or L-series storage in aligning dimensions.
- Grain runs vertical for sides and horizontal for front and back.
- 3/8" tall glides.
- Ships assembled.
- Weight capacity: 18 lbs per linear foot.

Calibrate Single Wrap Dry Planters

SINGLE WRAP DRY PLANTERS				
H	W	D	Model Number	List
34	30	18	X-CPSW343018	1,547
34	36	18	X-CPSW343618	1,649
34	42	18	X-CPSW344218	1,750
34	48	18	X-CPSW344818	1,852
34	54	18	X-CPSW345418	1,953
34	60	18	X-CPSW346018	2,055
34	66	18	X-CPSW346618	1,707
34	72	18	X-CPSW347218	1,808
34	78	18	X-CPSW347818	1,910
34	84	18	X-CPSW348418	2,011
34	30	24	X-CPSW343024	1,702
34	36	24	X-CPSW343624	1,803
34	42	24	X-CPSW344224	1,905
34	48	24	X-CPSW344824	2,006
34	54	24	X-CPSW345424	2,108
34	60	24	X-CPSW346024	2,209
34	66	24	X-CPSW346624	1,861
34	72	24	X-CPSW347224	1,963
34	78	24	X-CPSW347824	2,064
34	84	24	X-CPSW348424	2,166

SINGLE WRAP DRY PLANTERS				
H	W	D	Model Number	List
50	30	18	X-CPSW503018	2,046
50	36	18	X-CPSW503618	2,148
50	42	18	X-CPSW504218	2,249
50	48	18	X-CPSW504818	2,351
50	54	18	X-CPSW505418	2,452
50	60	18	X-CPSW506018	2,554
50	66	18	X-CPSW506618	2,257
50	72	18	X-CPSW507218	2,359
50	78	18	X-CPSW507818	2,460
50	84	18	X-CPSW508418	2,562
50	30	24	X-CPSW503024	2,251
50	36	24	X-CPSW503624	2,352
50	42	24	X-CPSW504224	2,454
50	48	24	X-CPSW504824	2,555
50	54	24	X-CPSW505424	2,657
50	60	24	X-CPSW506024	2,758
50	66	24	X-CPSW506624	2,462
50	72	24	X-CPSW507224	2,563
50	78	24	X-CPSW507824	2,665
50	84	24	X-CPSW508424	2,766

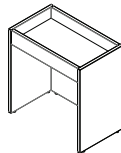

30"-54" Wide

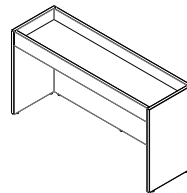

60"-84" Wide

Specify

Notes

- Laminate Selection with Matching Edge
- 1 1/8" Material Thickness.
- Planter box depth is 4.3".
- Only for use with artificial plants.
- Not intended for use with water or soil.
- For use with Calibrate storage only. 34"H units accommodate 28"H storage; 50"H units accommodate 42"H storage.
- Grain runs vertical on 30"-50" wide units; grain runs vertical for sides and horizontal for front and back on 60"-84" wide units.
- Ships knocked-down.
- Weight capacity: 18 lbs per linear foot.

Calibrate Double Wrap Dry Planters

DOUBLE WRAP DRY PLANTERS				
H	W	D	Model Number	List
34	30	36	X-CPDW343036	2,321
34	36	36	X-CPDW343636	2,473
34	42	36	X-CPDW344236	2,625
34	48	36	X-CPDW344836	2,777
34	54	36	X-CPDW345436	2,930
34	60	36	X-CPDW346036	3,082
34	66	36	X-CPDW346636	2,560
34	72	36	X-CPDW347236	2,712
34	78	36	X-CPDW347836	2,864
34	84	36	X-CPDW348436	3,017
34	30	48	X-CPDW343048	2,553
34	36	48	X-CPDW343648	2,705
34	42	48	X-CPDW344248	2,857
34	48	48	X-CPDW344848	3,010
34	54	48	X-CPDW345448	3,162
34	60	48	X-CPDW346048	3,314
34	66	48	X-CPDW346648	2,792
34	72	48	X-CPDW347248	2,944
34	78	48	X-CPDW347848	3,097
34	84	48	X-CPDW348448	3,249

DOUBLE WRAP DRY PLANTERS				
H	W	D	Model Number	List
50	30	36	X-CPDW503036	3,069
50	36	36	X-CPDW503636	3,221
50	42	36	X-CPDW504236	3,374
50	48	36	X-CPDW504836	3,526
50	54	36	X-CPDW505436	3,678
50	60	36	X-CPDW506036	3,830
50	66	36	X-CPDW506636	3,386
50	72	36	X-CPDW507236	3,538
50	78	36	X-CPDW507836	3,690
50	84	36	X-CPDW508436	3,842
50	30	48	X-CPDW503048	3,376
50	36	48	X-CPDW503648	3,528
50	42	48	X-CPDW504248	3,681
50	48	48	X-CPDW504848	3,833
50	54	48	X-CPDW505448	3,985
50	60	48	X-CPDW506048	4,137
50	66	48	X-CPDW506648	3,692
50	72	48	X-CPDW507248	3,845
50	78	48	X-CPDW507848	3,997
50	84	48	X-CPDW508448	4,149

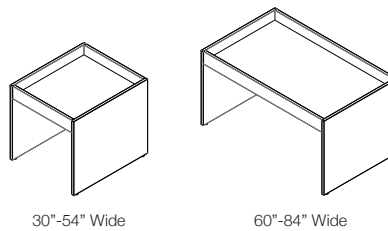

Specify

Notes

- Laminate Selection with Matching Edge
- 1 1/8" Material Thickness.
- Planter box depth is 4.3".
- Only for use with artificial plants.
- Not intended for use with water or soil.
- For use with Calibrate storage only. 34"H units accommodate 28"H storage; 50"H units accommodate 42"H storage.
- Grain runs vertical on 30"-54" wide units; grain runs vertical for sides and horizontal for front and back on 60"-84" wide units.
- Double wrap planters can fit two storage units back-to-back.
- Double wrap planters must be ganged to supporting storage.
- Ships knocked-down.
- Weight capacity: 18 lbs per linear foot.

Stack-On Bookcases

STACK-ON BOOKCASE

H	W	D	Model Number	List
37	18	14	X-SOBC3718	1,411
37	30	14	X-SOBC3730	1,571
37	36	14	X-SOBC3736	1,644
45	18	14	X-SOBC4518	1,471
45	30	14	X-SOBC4530	1,643
45	36	14	X-SOBC4536	1,718

STACK-ON BOOKCASE

H	W	D	Model Number	List
53	18	14	X-SOBC5318	1,651
53	30	14	X-SOBC5330	1,835
53	36	14	X-SOBC5336	1,915
61	18	14	X-SOBC6118	1,741
61	30	14	X-SOBC6130	1,960
61	36	14	X-SOBC6136	2,060

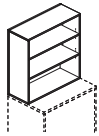

37" High

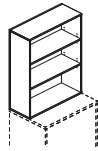

45" High

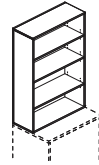

53" High

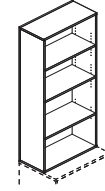

61" High

Specify

- Laminate Selection for Unit

Notes

- Shown on lower storage element.
- Right-Side Lock

STACK-ON BOOKCASE WITH SLIDING DOORS

H	W	D	Left-Handed	Right-Handed	List
			Model Number	Model Number	
37	30	14	X-SOSDL3730	X-SOSDR3730	2,482
37	36	14	X-SOSDL3736	X-SOSDR3736	2,557
37	42	14	X-SOSDL3742	X-SOSDR3742	2,644
45	30	14	X-SOSDL4530	X-SOSDR4530	2,581
45	36	14	X-SOSDL4536	X-SOSDR4536	2,663
45	42	14	X-SOSDL4542	X-SOSDR4542	2,760
53	30	14	X-SOSDL5330	X-SOSDR5330	2,803
53	36	14	X-SOSDL5336	X-SOSDR5336	2,895
53	42	14	X-SOSDL5342	X-SOSDR5342	3,004
61	30	14	X-SOSDL6130	X-SOSDR6130	2,958
61	36	14	X-SOSDL6136	X-SOSDR6136	3,071
61	42	14	X-SOSDL6142	X-SOSDR6142	3,197

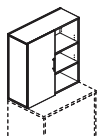

37" High

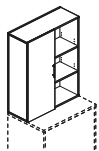

45" High

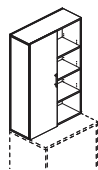

53" High

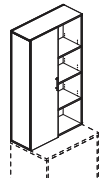

61" High

Specify

- Laminate Selection for Case
- Laminate Selection for Door/Face
- Handle Choice

Notes

- Left-handed bookcase shown on lower storage element.
- Right-Side Lock

Stack-On Cabinets and Wardrobes

STACK-ON TWO DOOR CABINET

H	W	D	Model Number	List
37	30	14	X-SOCD3730	2,138
37	36	14	X-SOCD3736	2,235
45	30	14	X-SOCD4530	2,307
45	36	14	X-SOCD4536	2,415
53	30	14	X-SOCD5330	2,598
53	36	14	X-SOCD5336	2,719
61	30	14	X-SOCD6130	2,770
61	36	14	X-SOCD6136	2,915

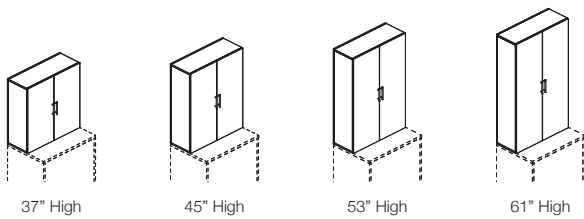

STACK-ON WARDROBE

H	W	D	Model Number	List
37	18	14	X-SOW3718	1,333
45	18	14	X-SOW4518	1,395
53	18	14	X-SOW5318	1,575
61	18	14	X-SOW6118	1,626

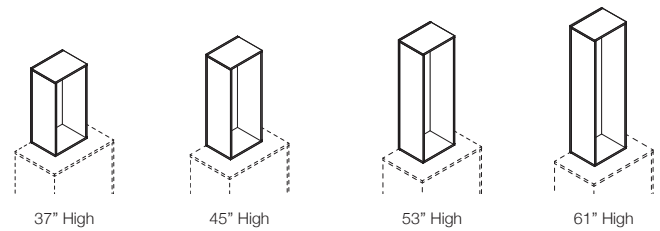

Specify

Notes

- Laminate Selection for Case
- Laminate Selection for Doors/Face
- Handle Choice
- Shown placed on lower storage element.
- Hooks included with cabinet.

Specify

Notes

- Laminate Selection for Unit
- Shown placed on lower storage element.
- Hooks included with wardrobe.
- Stack-on wardrobes do not have doors.

Open Hutches

37" HIGH SINGLE OPEN HUTCH

H	W	D	Model Number	List
37	36	14	X-SHO3736	1,834
37	42	14	X-SHO3742	1,885
37	48	14	X-SHO3748	1,950
37	54	14	X-SHO3754	2,214
37	60	14	X-SHO3760	2,276
37	66	14	X-SHO3766	2,341
37	72	14	X-SHO3772	2,403
37	78	14	X-SHO3778	2,466
37	84	14	X-SHO3784	2,524
37	90	14	X-SHO3790	2,587
37	96	14	X-SHO3796	2,649

45" HIGH SINGLE OPEN HUTCH

H	W	D	Model Number	List
45	36	14	X-SHO4536	1,909
45	42	14	X-SHO4542	1,969
45	48	14	X-SHO4548	2,038
45	54	14	X-SHO4554	2,311
45	60	14	X-SHO4560	2,376
45	66	14	X-SHO4566	2,451
45	72	14	X-SHO4572	2,519
45	78	14	X-SHO4578	2,587
45	84	14	X-SHO4584	2,653
45	90	14	X-SHO4590	2,720
45	96	14	X-SHO4596	2,789

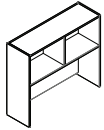

36" - 48" Wide

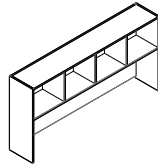

54" - 78" Wide

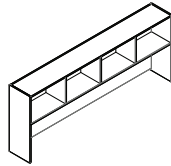

84" - 96" Wide

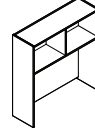

36" - 48" Wide

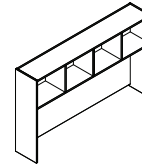

54" - 78" Wide

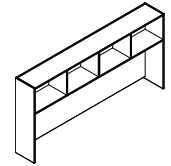

84" - 96" Wide

53" HIGH SINGLE OPEN HUTCH

H	W	D	Model Number	List
53	36	14	X-SHO5336	1,979
53	42	14	X-SHO5342	2,046
53	48	14	X-SHO5348	2,124
53	54	14	X-SHO5354	2,399
53	60	14	X-SHO5360	2,473
53	66	14	X-SHO5366	2,554
53	72	14	X-SHO5372	2,627
53	78	14	X-SHO5378	2,700
53	84	14	X-SHO5384	2,773
53	90	14	X-SHO5390	2,846
53	96	14	X-SHO5396	2,921

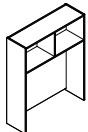

36" - 48" Wide

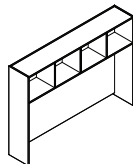

54" - 78" Wide

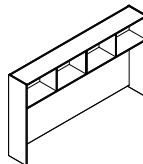

84" - 96" Wide

Specify

Notes

- Laminate Selection for Unit

Open Hutches

53" HIGH DOUBLE OPEN HUTCH

H	W	D	Model Number	List
53	36	14	X-DHO5336	2,211
53	42	14	X-DHO5342	2,294
53	48	14	X-DHO5348	2,388
53	54	14	X-DHO5354	2,731
53	60	14	X-DHO5360	2,816
53	66	14	X-DHO5366	2,910
53	72	14	X-DHO5372	2,992
53	78	14	X-DHO5378	3,076

61" HIGH DOUBLE OPEN HUTCH

H	W	D	Model Number	List
61	36	14	X-DHBC6136	2,280
61	42	14	X-DHBC6142	2,370
61	48	14	X-DHBC6148	2,469
61	54	14	X-DHBC6154	2,820
61	60	14	X-DHBC6160	2,912
61	66	14	X-DHBC6166	3,008
61	72	14	X-DHBC6172	3,099
61	78	14	X-DHBC6178	3,197

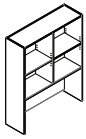

36" - 48" Wide

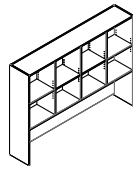

54" - 78" Wide

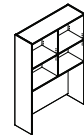

36" - 48" Wide

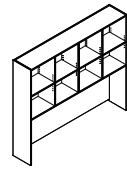

54" - 78" Wide

Specify

Notes

- Laminate Selection for Unit

Hutches with Cabinet Doors

37" HIGH SINGLE HUTCH WITH CABINET DOORS

H	W	D	Model Number	List
37	36	14	X-SHCD3736	2,270
37	42	14	X-SHCD3742	2,345
37	48	14	X-SHCD3748	2,429
37	54	14	X-SHCD3754	2,851
37	60	14	X-SHCD3760	2,923
37	66	14	X-SHCD3766	3,006
37	72	14	X-SHCD3772	3,083
37	78	14	X-SHCD3778	3,156
37	84	14	X-SHCD3784	3,204
37	90	14	X-SHCD3790	3,273
37	96	14	X-SHCD3796	3,339

37" HIGH SINGLE HUTCH WITH FRAMED CABINET DOORS

H	W	D	Model Number	List
37	36	14	X-SHGD3736	3,150
37	42	14	X-SHGD3742	3,364
37	48	14	X-SHGD3748	3,577
37	54	14	X-SHGD3754	4,212
37	60	14	X-SHGD3760	4,419
37	66	14	X-SHGD3766	4,636
37	72	14	X-SHGD3772	4,846
37	78	14	X-SHGD3778	5,054
37	84	14	X-SHGD3784	4,747
37	90	14	X-SHGD3790	4,913
37	96	14	X-SHGD3796	5,082

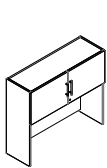

36" - 48" Wide

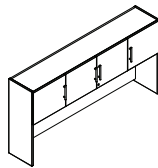

54" - 78" Wide

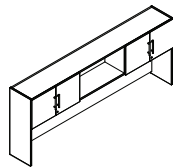

84" - 96" Wide

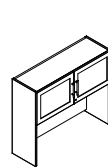

36" - 48" Wide

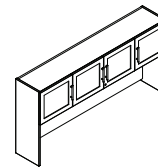

54" - 78" Wide

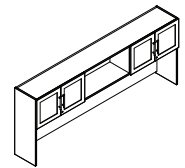

84" - 96" Wide

45" HIGH SINGLE HUTCH WITH CABINET DOORS

H	W	D	Model Number	List
45	36	14	X-SHCD4536	2,346
45	42	14	X-SHCD4542	2,430
45	48	14	X-SHCD4548	2,518
45	54	14	X-SHCD4554	2,946
45	60	14	X-SHCD4560	3,027
45	66	14	X-SHCD4566	3,114
45	72	14	X-SHCD4572	3,197
45	78	14	X-SHCD4578	3,286
45	84	14	X-SHCD4584	3,331
45	90	14	X-SHCD4590	3,406
45	96	14	X-SHCD4596	3,479

45" HIGH SINGLE HUTCH WITH FRAMED CABINET DOORS

H	W	D	Model Number	List
45	36	14	X-SHGD4536	3,228
45	42	14	X-SHGD4542	3,445
45	48	14	X-SHGD4548	3,668
45	54	14	X-SHGD4554	4,304
45	60	14	X-SHGD4560	4,522
45	66	14	X-SHGD4566	4,745
45	72	14	X-SHGD4572	4,960
45	78	14	X-SHGD4578	5,182
45	84	14	X-SHGD4584	4,876
45	90	14	X-SHGD4590	5,049
45	96	14	X-SHGD4596	5,222

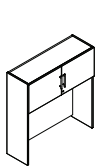

36" - 48" Wide

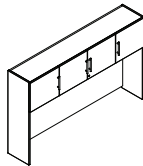

54" - 78" Wide

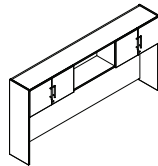

84" - 96" Wide

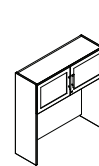

36" - 48" Wide

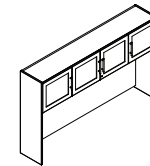

54" - 78" Wide

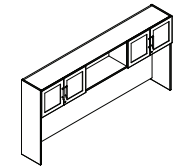

84" - 96" Wide

Specify

Notes

- Laminate Selection for Case
- Laminate Selection for Door/Face
- Handle Choice

Hutches with Cabinet Doors

53" HIGH SINGLE HUTCH WITH CABINET DOORS

H	W	D	Model Number	List
53	36	14	X-SHCD5336	2,415
53	42	14	X-SHCD5342	2,506
53	48	14	X-SHCD5348	2,600
53	54	14	X-SHCD5354	3,033
53	60	14	X-SHCD5360	3,122
53	66	14	X-SHCD5366	3,217
53	72	14	X-SHCD5372	3,304
53	78	14	X-SHCD5378	3,394
53	84	14	X-SHCD5384	3,450
53	90	14	X-SHCD5390	3,532
53	96	14	X-SHCD5396	3,612

53" HIGH SINGLE HUTCH WITH FRAMED CABINET DOORS

H	W	D	Model Number	List
53	36	14	X-SHGD5336	3,298
53	42	14	X-SHGD5342	3,520
53	48	14	X-SHGD5348	3,749
53	54	14	X-SHGD5354	4,395
53	60	14	X-SHGD5360	4,617
53	66	14	X-SHGD5366	4,846
53	72	14	X-SHGD5372	5,069
53	78	14	X-SHGD5378	5,291
53	84	14	X-SHGD5384	4,998
53	90	14	X-SHGD5390	5,175
53	96	14	X-SHGD5396	5,356

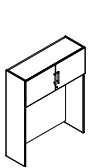

36" - 48" Wide

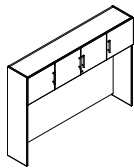

54" - 78" Wide

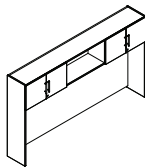

84" - 96" Wide

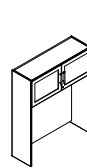

36" - 48" Wide

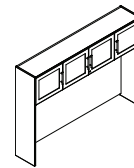

54" - 78" Wide

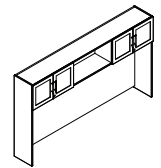

84" - 96" Wide

53" HIGH DOUBLE HUTCH WITH CABINET DOORS

H	W	D	Model Number	List
53	36	14	X-DHCD5336	2,600
53	42	14	X-DHCD5342	2,711
53	48	14	X-DHCD5348	2,829
53	54	14	X-DHCD5354	3,384
53	60	14	X-DHCD5360	3,495
53	66	14	X-DHCD5366	3,612
53	72	14	X-DHCD5372	3,723
53	78	14	X-DHCD5378	3,833

53" HIGH DOUBLE HUTCH WITH FRAMED CABINET DOORS

H	W	D	Model Number	List
53	36	14	X-DHGD5336	4,276
53	42	14	X-DHGD5342	4,638
53	48	14	X-DHGD5348	5,010
53	54	14	X-DHGD5354	5,976
53	60	14	X-DHGD5360	6,340
53	66	14	X-DHGD5366	6,709
53	72	14	X-DHGD5372	7,072
53	78	14	X-DHGD5378	7,437

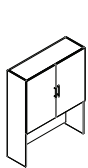

36" - 48" Wide

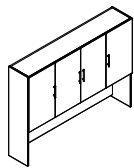

54" - 78" Wide

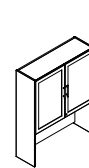

36" - 48" Wide

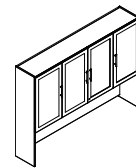

54" - 78" Wide

Specify

Notes

- Laminate Selection for Case
- Laminate Selection for Door/Face
- Handle Choice

Hutches with Cabinet Doors

61" HIGH DOUBLE HUTCH WITH CABINET DOORS

H	W	D	Model Number	List
61	36	14	X-DHCD6136	2,669
61	42	14	X-DHCD6142	2,789
61	48	14	X-DHCD6148	2,912
61	54	14	X-DHCD6154	3,475
61	60	14	X-DHCD6160	3,589
61	66	14	X-DHCD6166	3,714
61	72	14	X-DHCD6172	3,831
61	78	14	X-DHCD6178	3,951

61" HIGH DOUBLE HUTCH WITH FRAMED CABINET DOORS

H	W	D	Model Number	List
61	36	14	X-DHGD6136	4,344
61	42	14	X-DHGD6142	4,715
61	48	14	X-DHGD6148	5,093
61	54	14	X-DHGD6154	6,063
61	60	14	X-DHGD6160	6,435
61	66	14	X-DHGD6166	6,812
61	72	14	X-DHGD6172	7,180
61	78	14	X-DHGD6178	7,552

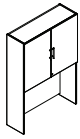

36" - 48" Wide

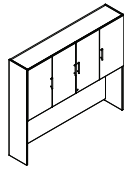

54" - 78" Wide

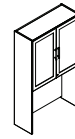

36" - 48" Wide

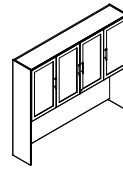

54" - 78" Wide

Specify

Notes

- Laminate Selection for Case
- Laminate Selection for Door/Face
- Handle Choice

Hutches with Sliding Doors

37" HIGH SINGLE HUTCH WITH SLIDING DOORS

H	W	D	Left-Side Lock	Right-Side Lock	List
			Model Number	Model Number	
37	36	14	X-SHSDL3736	X-SHSDR3736	2,421
37	42	14	X-SHSDL3742	X-SHSDR3742	2,488
37	48	14	X-SHSDL3748	X-SHSDR3748	2,563
37	54	14	X-SHSDL3754	X-SHSDR3754	2,829
37	60	14	X-SHSDL3760	X-SHSDR3760	2,897
37	66	14	X-SHSDL3766	X-SHSDR3766	2,975
37	72	14	X-SHSDL3772	X-SHSDR3772	3,044
37	78	14	X-SHSDL3778	X-SHSDR3778	3,112
37	84	14	X-SHSD3784		3,449
37	90	14	X-SHSD3790		3,519
37	96	14	X-SHSD3796		3,588

37" HIGH SINGLE HUTCH WITH FRAMED SLIDING DOORS

H	W	D	Left-Side Lock	Right-Side Lock	List
			Model Number	Model Number	
37	36	14	X-SHGSDL3736	X-SHGSDR3736	2,861
37	42	14	X-SHGSDL3742	X-SHGSDR3742	2,995
37	48	14	X-SHGSDL3748	X-SHGSDR3748	3,139
37	54	14	X-SHGSDL3754	X-SHGSDR3754	3,472
37	60	14	X-SHGSDL3760	X-SHGSDR3760	3,608
37	66	14	X-SHGSDL3766	X-SHGSDR3766	3,750
37	72	14	X-SHGSDL3772	X-SHGSDR3772	3,888
37	78	14	X-SHGSDL3778	X-SHGSDR3778	4,021
37	84	14	X-SHGSD3784		4,762
37	90	14	X-SHGSD3790		4,921
37	96	14	X-SHGSD3796		5,080

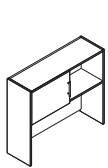

36" - 48" Wide
(Left-Side Lock)

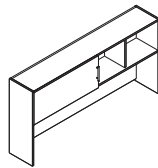

54" - 78" Wide
(Left-Side Lock)

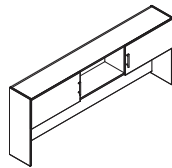

84" - 96" Wide
(Non-Handed)

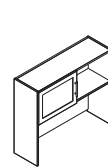

36" - 48" Wide
(Left-Side Lock)

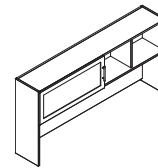

54" - 78" Wide
(Left-Side Lock)

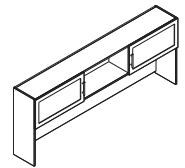

84" - 96" Wide
(Non-Handed)

45" HIGH SINGLE HUTCH WITH SLIDING DOORS

H	W	D	Left-Side Lock	Right-Side Lock	List
			Model Number	Model Number	
45	36	14	X-SHSDL4536	X-SHSDR4536	2,499
45	42	14	X-SHSDL4542	X-SHSDR4542	2,572
45	48	14	X-SHSDL4548	X-SHSDR4548	2,654
45	54	14	X-SHSDL4554	X-SHSDR4554	2,925
45	60	14	X-SHSDL4560	X-SHSDR4560	2,999
45	66	14	X-SHSDL4566	X-SHSDR4566	3,084
45	72	14	X-SHSDL4572	X-SHSDR4572	3,157
45	78	14	X-SHSDL4578	X-SHSDR4578	3,236
45	84	14	X-SHSD4584		3,580
45	90	14	X-SHSD4590		3,657
45	96	14	X-SHSD4596		3,730

45" HIGH SINGLE HUTCH WITH FRAMED SLIDING DOORS

H	W	D	Left-Side Lock	Right-Side Lock	List
			Model Number	Model Number	
45	36	14	X-SHGSDL4536	X-SHGSDR4536	2,940
45	42	14	X-SHGSDL4542	X-SHGSDR4542	3,081
45	48	14	X-SHGSDL4548	X-SHGSDR4548	3,228
45	54	14	X-SHGSDL4554	X-SHGSDR4554	3,567
45	60	14	X-SHGSDL4560	X-SHGSDR4560	3,709
45	66	14	X-SHGSDL4566	X-SHGSDR4566	3,859
45	72	14	X-SHGSDL4572	X-SHGSDR4572	4,002
45	78	14	X-SHGSDL4578	X-SHGSDR4578	4,143
45	84	14	X-SHGSD4584		4,891
45	90	14	X-SHGSD4590		5,055
45	96	14	X-SHGSD4596		5,220

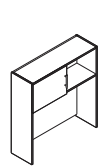

36" - 48" Wide
(Left-Side Lock)

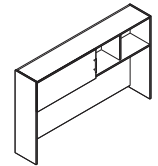

54" - 78" Wide
(Left-Side Lock)

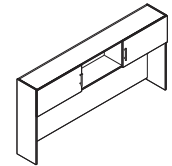

84" - 96" Wide
(Non-Handed)

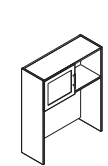

36" - 48" Wide
(Left-Side Lock)

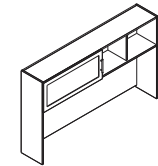

54" - 78" Wide
(Left-Side Lock)

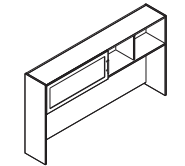

84" - 96" Wide
(Non-Handed)

Specify

- Laminate Selection for Case
- Laminate Selection for Door/Face
- Handle Choice

Notes

- Left-side lock hutches shown for sizes 36" - 78" wide.
- Sizes 84" - 96" wide are non-handed.
- Non-handed units (84"-96" wide) lock on both sides.

Hutches with Sliding Doors

53" HIGH SINGLE HUTCH WITH SLIDING DOORS

H	W	D	Left-Side Lock	Right-Side Lock	List
			Model Number	Model Number	
53	36	14	X-SHSDL5336	X-SHSDR5336	2,568
53	42	14	X-SHSDL5342	X-SHSDR5342	2,650
53	48	14	X-SHSDL5348	X-SHSDR5348	2,736
53	54	14	X-SHSDL5354	X-SHSDR5354	3,015
53	60	14	X-SHSDL5360	X-SHSDR5360	3,097
53	66	14	X-SHSDL5366	X-SHSDR5366	3,184
53	72	14	X-SHSDL5372	X-SHSDR5372	3,266
53	78	14	X-SHSDL5378	X-SHSDR5378	3,355
53	84	14	X-SHSD5384		3,701
53	90	14	X-SHSD5390		3,780
53	96	14	X-SHSD5396		3,863

53" HIGH SINGLE HUTCH WITH FRAMED SLIDING DOORS

H	W	D	Left-Side Lock	Right-Side Lock	List
			Model Number	Model Number	
53	36	14	X-SHGSDL5336	X-SHGSDR5336	3,007
53	42	14	X-SHGSDL5342	X-SHGSDR5342	3,155
53	48	14	X-SHGSDL5348	X-SHGSDR5348	3,313
53	54	14	X-SHGSDL5354	X-SHGSDR5354	3,658
53	60	14	X-SHGSDL5360	X-SHGSDR5360	3,804
53	66	14	X-SHGSDL5366	X-SHGSDR5366	3,961
53	72	14	X-SHGSDL5372	X-SHGSDR5372	4,109
53	78	14	X-SHGSDL5378	X-SHGSDR5378	4,263
53	84	14	X-SHGSD5384		5,012
53	90	14	X-SHGSD5390		5,183
53	96	14	X-SHGSD5396		5,355

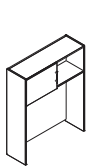

36" - 48" Wide
(Left-Side Lock)

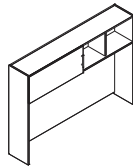

54" - 78" Wide
(Left-Side Lock)

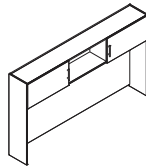

84" - 96" Wide
(Non-Handed)

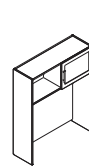

36" - 48" Wide
(Left-Side Lock)

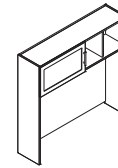

54" - 78" Wide
(Left-Side Lock)

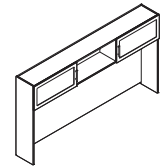

84" - 96" Wide
(Non-Handed)

53" HIGH DOUBLE HUTCH WITH SLIDING DOORS

H	W	D	Left-Side Lock	Right-Side Lock	List
			Model Number	Model Number	
53	36	14	X-DHSDL5336	X-DHSDR5336	2,700
53	42	14	X-DHSDL5342	X-DHSDR5342	2,797
53	48	14	X-DHSDL5348	X-DHSDR5348	2,901
53	54	14	X-DHSDL5354	X-DHSDR5354	3,260
53	60	14	X-DHSDL5360	X-DHSDR5360	3,364
53	66	14	X-DHSDL5366	X-DHSDR5366	3,468
53	72	14	X-DHSDL5372	X-DHSDR5372	3,564
53	78	14	X-DHSDL5378	X-DHSDR5378	3,663

53" HIGH DOUBLE HUTCH WITH FRAMED SLIDING DOORS

H	W	D	Left-Side Lock	Right-Side Lock	List
			Model Number	Model Number	
53	36	14	X-DHGSDL5336	X-DHGSDR5336	3,536
53	42	14	X-DHGSDL5342	X-DHGSDR5342	3,760
53	48	14	X-DHGSDL5348	X-DHGSDR5348	3,992
53	54	14	X-DHGSDL5354	X-DHGSDR5354	4,446
53	60	14	X-DHGSDL5360	X-DHGSDR5360	4,668
53	66	14	X-DHGSDL5366	X-DHGSDR5366	4,895
53	72	14	X-DHGSDL5372	X-DHGSDR5372	5,114
53	78	14	X-DHGSDL5378	X-DHGSDR5378	5,337

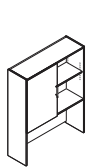

36" - 48" Wide
(Left-Side Lock)

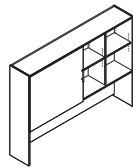

54" - 78" Wide
(Left-Side Lock)



36" - 48" Wide
(Left-Side Lock)

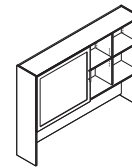

54" - 78" Wide
(Left-Side Lock)

Specify

- Laminate Selection for Case
- Laminate Selection for Door/Face
- Handle Choice

Notes

- Left-side lock hutches shown for sizes 36" - 78" wide.
- Sizes 84" - 96" wide are non-handed.
- Non-handed units (84" - 96" wide) lock on both sides.

Hutches with Sliding Doors

61" HIGH SINGLE HUTCH WITH SLIDING DOORS

H	W	D	Left-Side Lock	Right-Side Lock	List
			Model Number	Model Number	
61	36	14	X-DHSDL6136	X-DHSDR6136	2,769
61	42	14	X-DHSDL6142	X-DHSDR6142	2,873
61	48	14	X-DHSDL6148	X-DHSDR6148	2,985
61	54	14	X-DHSDL6154	X-DHSDR6154	3,351
61	60	14	X-DHSDL6160	X-DHSDR6160	3,455
61	66	14	X-DHSDL6166	X-DHSDR6166	3,567
61	72	14	X-DHSDL6172	X-DHSDR6172	3,671
61	78	14	X-DHSDL6178	X-DHSDR6178	3,777

61" HIGH SINGLE HUTCH WITH FRAMED SLIDING DOORS

H	W	D	Left-Side Lock	Right-Side Lock	List
			Model Number	Model Number	
61	36	14	X-DHGSDL6136	X-DHGSDR6136	3,607
61	42	14	X-DHGSDL6142	X-DHGSDR6142	3,834
61	48	14	X-DHGSDL6148	X-DHGSDR6148	4,072
61	54	14	X-DHGSDL6154	X-DHGSDR6154	4,534
61	60	14	X-DHGSDL6160	X-DHGSDR6160	4,761
61	66	14	X-DHGSDL6166	X-DHGSDR6166	4,998
61	72	14	X-DHGSDL6172	X-DHGSDR6172	5,223
61	78	14	X-DHGSDL6178	X-DHGSDR6178	5,451

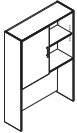

36" - 48" Wide
(Left-Side Lock)

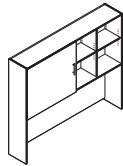

54" - 78" Wide
(Left-Side Lock)

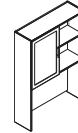

36" - 48" Wide
(Left-Side Lock)

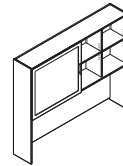

54" - 78" Wide
(Left-Side Lock)

Specify

- Laminate Selection for Case
- Laminate Selection for Door/Face
- Handle Choice

Notes

- Left-side lock hutches shown.

Wall Mounted Tackboards

WALL MOUNTED TACKBOARDS					WALL MOUNTED TACKBOARDS WITH TOOL RAILS				
H	W	Model Number	List	Fabric Grade C	H	W	Model Number	List	Fabric Grade C
20	36	X-TACKWM2036	783	+27	20	36	X-TACKWMT1036	950	+11
20	42	X-TACKWM2042	795	+27	20	42	X-TACKWMT1042	968	+11
20	48	X-TACKWM2048	814	+27	20	48	X-TACKWMT1048	1,009	+11
20	54	X-TACKWM2054	835	+27	20	54	X-TACKWMT1054	1,043	+11
20	60	X-TACKWM2060	855	+27	20	60	X-TACKWMT1060	978	+11
20	66	X-TACKWM2066	875	+54	20	66	X-TACKWMT1066	988	+22
20	72	X-TACKWM2072	898	+54	20	72	X-TACKWMT1072	1,032	+22
20	78	X-TACKWM2078	917	+54	20	78	X-TACKWMT1078	1,051	+22
20	84	X-TACKWM2084	938	+81	20	84	X-TACKWMT1084	1,122	+33
20	90	X-TACKWM2090	956	+81	20	90	X-TACKWMT1090	1,138	+33
20	96	X-TACKWM2096	978	+81	20	96	X-TACKWMT1096	1,180	+33
28	36	X-TACKWM2836	830	+34	28	36	X-TACKWMT1436	995	+19
28	42	X-TACKWM2842	844	+34	28	42	X-TACKWMT1442	1,026	+19
28	48	X-TACKWM2848	861	+34	28	48	X-TACKWMT1448	1,056	+19
28	54	X-TACKWM2854	876	+34	28	54	X-TACKWMT1454	1,087	+19
28	60	X-TACKWM2860	891	+34	28	60	X-TACKWMT1460	1,115	+19
28	66	X-TACKWM2866	997	+68	28	66	X-TACKWMT1466	1,145	+38
28	72	X-TACKWM2872	1,029	+68	28	72	X-TACKWMT1472	1,173	+38
28	78	X-TACKWM2878	1,082	+68	28	78	X-TACKWMT1478	1,206	+38
28	84	X-TACKWM2884	1,110	+102	28	84	X-TACKWMT1484	1,236	+57
28	90	X-TACKWM2890	1,139	+102	28	90	X-TACKWMT1490	1,262	+57
28	96	X-TACKWM2896	1,171	+102	28	96	X-TACKWMT1496	1,292	+57
35	36	X-TACKWM3536	876	+42	35	36	X-TACKWMT1736	1,041	+27
35	42	X-TACKWM3542	896	+42	35	42	X-TACKWMT1742	1,086	+27
35	48	X-TACKWM3548	916	+42	35	48	X-TACKWMT1748	1,126	+27
35	54	X-TACKWM3554	938	+42	35	54	X-TACKWMT1754	1,167	+27
35	60	X-TACKWM3560	956	+42	35	60	X-TACKWMT1760	1,207	+27
35	66	X-TACKWM3566	1,049	+84	35	66	X-TACKWMT1766	1,248	+54
35	72	X-TACKWM3572	1,083	+84	35	72	X-TACKWMT1772	1,288	+54
35	78	X-TACKWM3578	1,138	+84	35	78	X-TACKWMT1778	1,329	+54
35	84	X-TACKWM3584	1,173	+126	35	84	X-TACKWMT1784	1,369	+81
35	90	X-TACKWM3590	1,208	+126	35	90	X-TACKWMT1790	1,411	+81
35	96	X-TACKWM3596	1,244	+126	35	96	X-TACKWMT1796	1,446	+81

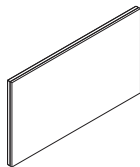

Without Tool Rail

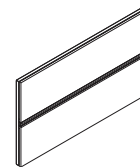

With Tool Rail

Specify

- Fabric Selection

Notes

- Tackboard thickness: 1/2"
- Select sizes available on quick ship Calibrate Countdown program. See [Calibrate Countdown price list](#) for full details.

VERTICAL WALL MOUNTED TACKBOARD

H	W	Model Number	List	Fabric Grade C
37	24	X-TACKSW3724	874	+27
37	30	X-TACKSW3730	888	+27
37	36	X-TACKSW3736	904	+27
45	24	X-TACKSW4524	920	+34
45	30	X-TACKSW4530	937	+34
45	36	X-TACKSW4536	951	+34
53	24	X-TACKPW5324	968	+42
53	30	X-TACKPW5330	982	+42
53	36	X-TACKPW5336	996	+42
61	24	X-TACKSW6124	1,016	+56
61	30	X-TACKSW6130	1,029	+56
61	36	X-TACKSW6136	1,045	+56



Specify

Notes

• Fabric Selection

• Tackboard thickness: 1/2"

Tackboard Hutch Mounts for Calibrate

TACKBOARD HUTCH MOUNT				
H	W	Model Number	List	Fabric Grade C
20	36	X-TACKHM2036	714	+27
20	42	X-TACKHM2042	736	+27
20	48	X-TACKHM2048	758	+27
20	54	X-TACKHM2054	778	+27
20	60	X-TACKHM2060	800	+27
20	66	X-TACKHM2066	825	+54
20	72	X-TACKHM2072	843	+54
20	78	X-TACKHM2078	866	+54
20	84	X-TACKHM2084	886	+81
20	90	X-TACKHM2090	908	+81
20	96	X-TACKHM2096	960	+81
28	36	X-TACKHM2836	739	+34
28	42	X-TACKHM2842	767	+34
28	48	X-TACKHM2848	799	+34
28	54	X-TACKHM2854	829	+34
28	60	X-TACKHM2860	856	+34
28	66	X-TACKHM2866	886	+68
28	72	X-TACKHM2872	916	+68
28	78	X-TACKHM2878	944	+68
28	84	X-TACKHM2884	975	+102
28	90	X-TACKHM2890	1,002	+102
28	96	X-TACKHM2896	1,031	+102
35	36	X-TACKHM3536	864	+42
35	42	X-TACKHM3542	900	+42
35	48	X-TACKHM3548	937	+42
35	54	X-TACKHM3554	972	+42
35	60	X-TACKHM3560	1,007	+42
35	66	X-TACKHM3566	1,043	+84
35	72	X-TACKHM3572	1,077	+84
35	78	X-TACKHM3578	1,115	+84
35	84	X-TACKHM3584	1,150	+126
35	90	X-TACKHM3590	1,186	+126
35	96	X-TACKHM3596	1,222	+126

TACKBOARD HUTCH MOUNT WITH TOOL RAIL				
H	W	Model Number	List	Fabric Grade C
20	36	X-TACKHMT1036	917	+11
20	42	X-TACKHMT1042	941	+11
20	48	X-TACKHMT1048	966	+11
20	54	X-TACKHMT1054	991	+11
20	60	X-TACKHMT1060	1,018	+11
20	66	X-TACKHMT1066	1,038	+22
20	72	X-TACKHMT1072	1,065	+22
20	78	X-TACKHMT1078	1,090	+22
20	84	X-TACKHMT1084	1,115	+33
20	90	X-TACKHMT1090	1,139	+33
20	96	X-TACKHMT1096	1,166	+33
28	36	X-TACKHMT1436	985	+19
28	42	X-TACKHMT1442	1,016	+19
28	48	X-TACKHMT1448	1,043	+19
28	54	X-TACKHMT1454	1,071	+19
28	60	X-TACKHMT1460	1,100	+19
28	66	X-TACKHMT1466	1,131	+38
28	72	X-TACKHMT1472	1,161	+38
28	78	X-TACKHMT1478	1,187	+38
28	84	X-TACKHMT1484	1,218	+57
28	90	X-TACKHMT1490	1,248	+57
28	96	X-TACKHMT1496	1,278	+57
35	36	X-TACKHMT1736	1,030	+27
35	42	X-TACKHMT1742	1,070	+27
35	48	X-TACKHMT1748	1,109	+27
35	54	X-TACKHMT1754	1,149	+27
35	60	X-TACKHMT1760	1,187	+27
35	66	X-TACKHMT1766	1,228	+54
35	72	X-TACKHMT1772	1,267	+54
35	78	X-TACKHMT1778	1,309	+54
35	84	X-TACKHMT1784	1,348	+81
35	90	X-TACKHMT1790	1,388	+81
35	96	X-TACKHMT1796	1,426	+81

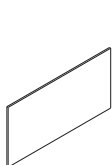

20" High

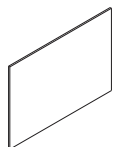

28" High

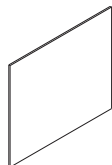

35" High

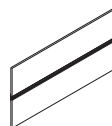

20" High

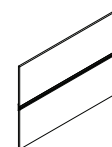

28" High



35" High

Specify

• Fabric Selection

Notes

• Tackboard thickness: 1/2"

Paper Flows

HANGING SORTER

Model Number	List
L-HS	269

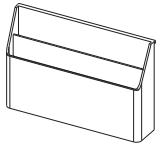

MINI-SHELF

Model Number	List
L-MS	104

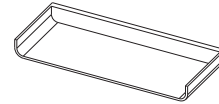

LANDSCAPE PAPER TRAY

Model Number	List
L-LPT	125

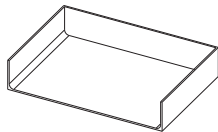

TOOL CUP

Model Number	List
L-TC	104

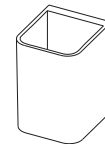

Notes

- Calibrate paper flows available only in white plastic.
- For use with Calibrate tool rails only.

Drawers

SPIN-OUT DRAWERS

W	D	Type	Model Number	List
7 1/2	7 1/2	Radius Jr.	A-ROKJ	185
13 5/8	8 1/4	Radius	A-ROK	210



Radius Jr.

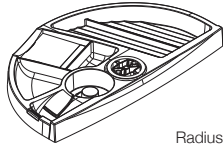

Radius

Specify

Notes

PENCIL DRAWER

H	W	D	Model Number	List
2 1/4	21 1/4	16 1/4	A-PDRWP	265

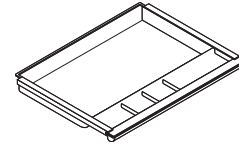

Notes

- Pencil Drawer provides convenient, low profile storage of loose items.
- Constructed of rigid, durable PVC with black textured finish.
- Plastic slides mount underneath worksurfaces with screws provided.
- Pencil drawer measures 16 1/4" deep x 21 1/4" wide x 2 1/4" high.
- Plan pencil drawer location around worksurface support elements.
- Select sizes available on quick ship Calibrate Countdown program. See [Calibrate Countdown price list](#) for full details.

PELICAN DRAWER I

H	W	D	File Rods	Model Number	List
10	19 1/4	23 3/8	No	A-PDP1	1,464
10	19 1/4	23 3/8	Yes	A-PDP1R	1,505

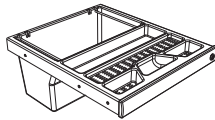

Notes

- Provides secure storage for large items such as purses, laptops or hanging files.
- Features fully concealed drawer slides and a spacious segmented tray section.
- Soft durable drawer front protects clothing and chair arms.
- Key core interchangeable locks compatible with most office furniture systems.
- Mount under any 23 3/8" deep surface. Fits all AIS furniture systems.
- Has a 10" bin height.
- Leg room 13" (front edge to bin).
- May not be keyed alike to other storage units.

PELICAN DRAWER II

H	W	D	Model Number	List
10	19 1/4	16 1/4	A-PDP2	1,640

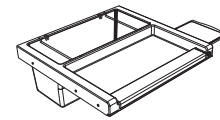

Notes

- Provides secure storage for large items such as purses, laptops or hanging files.
- Features fully concealed drawer slides and a spacious segmented tray section.
- Soft durable drawer front protects clothing and chair arms.
- Key core interchangeable locks compatible with most office furniture systems.
- Mount under any 23 3/8" deep surface. Fits all AIS furniture systems.
- Has a 10" bin height.
- Leg room 13" (front edge to bin).
- May not be keyed alike to other storage units.

Locks and Keys

LOCK CORES AND KEYS

Key Type	Model Number	List
Core with 2 keys	S-W1CORE1	20
Core with 2 keys (set of 2 keyed alike)	S-W1CORE2	32
Core with 2 keys (set of 3 keyed alike)	S-W1CORE3	49
Core with 2 keys (set of 4 keyed alike)	S-W1CORE4	63
Core with 2 keys (set of 5 keyed alike)	S-W1CORE5	79
Core with 2 keys (set of 6 keyed alike)	S-W1CORE6	92
Core with 2 keys (set of 7 keyed alike)	S-W1CORE7	107
Core with 2 keys (set of 8 keyed alike)	S-W1CORE8	124
Core with 2 keys (set of 9 keyed alike)	S-W1CORE9	138
Core with 2 keys (set of 10 keyed alike)	S-W1CORE10	153
Master Key	RS-W1MKEY	15
Core Removal Key	RS-W1CRKEY	15
Replacement Key	RS-WK ___ (Key Number)	22

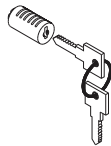

Notes

- Lock Cores & Keys are included with all AIS storage but may be ordered separately for keying stations alike or for replacement purposes.
- Keys and Lock Cores are available in #'s 226 through 425.
- When ordering keyed alike sets, be sure to also order an LL core removal key.
- The core removal key is needed to remove the existing core from the lock housing in order to replace with a new core.
- Order sets based on quantity of storage items to be keyed alike.
- Select sizes available on quick ship Calibrate Countdown program. See [Calibrate Countdown price list](#) for full details.

DIGITAL LOCKS

Model Number	List
A-DLVK	1,338



Notes

- Surface mount retrofit into existing mechanical locks.
- Motorized locking engagement with manual knob.
- Powerful and easy administration with Smartphone App.
- Access with keypad or free 'Wesko Lock App'.
- Available in satin finish only.
- Locks may be programmed for either a Shared Use Mode for multiple users or Resident Mode to retain a single the lock code.
- Digital locks require field pre-drilling and installation. Template for pre-drilling is provided withlocks.

DIGITAL LOCK CHARGING UNITS

Type	Model Number	List
Single	A-DLCS	265
10 Port	A-DLCT	2,592

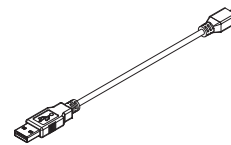

Single Unit

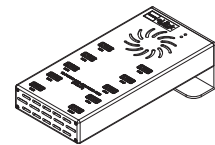

10 Port Unit

Notes

- 10 port USB 2.0 charger provides up to 5V/500mA per port to charge 10 digital locks at the same time.
- Features LED charge indicators (red for on/off switch - blue for each port), built-in safety protection for over-current, over-voltage and short circuit protection.
- 10 port power adapter output of 12V/10A, single unit power adapter output of 3V/1A.
- Available in black.
- 10 port dimensions: 190 x 80 x 54mm.

Credenza and Pedestal Cushions

CREDENZA CUSHIONS

D	W	Model Number	List	Upholstery Grade B	Upholstery Grade C	Upholstery Grade D	Upholstery Grade E
18	18	S-BCUSH1818	955	+51	+102	+152	+203
18	21	S-BCUSH1821	1,006	+51	+102	+152	+203
18	24	S-BCUSH1824	1,025	+51	+102	+152	+203
18	27	S-BCUSH1827	1,043	+51	+102	+152	+203
18	30	S-BCUSH1830	1,061	+62	+124	+186	+248
18	33	S-BCUSH1833	1,075	+62	+124	+186	+248
18	36	S-BCUSH1836	1,141	+62	+124	+186	+248
18	42	S-BCUSH1842	1,183	+73	+146	+208	+270
18	48	S-BCUSH1848	1,248	+73	+146	+208	+270
18	54	S-BCUSH1854	1,294	+73	+146	+208	+270
18	60	S-BCUSH1860	1,328	+95	+160	+228	+298
18	66	S-BCUSH1866	1,412	+95	+160	+228	+298
18	72	S-BCUSH1872	1,455	+95	+160	+228	+298

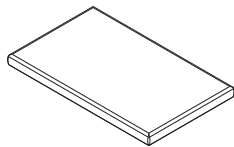

SHARED CREDENZA CUSHIONS

D	W	Model Number	List	Upholstery Grade C	Upholstery Grade D	Upholstery Grade E
36	30	S-BCUSH3630	1,585	+95	+160	+228
36	36	S-BCUSH3636	1,625	+95	+160	+228
36	42	S-BCUSH3642	1,641	+95	+160	+228

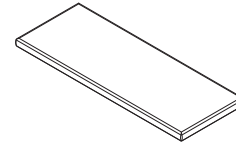

PEDESTAL CUSHIONS

D	W	Model Number	List	Upholstery Grade B	Upholstery Grade C	Upholstery Grade D	Upholstery Grade E
22	15	S-PEDCUSHIONJ1	538	+51	+102	+152	+203
24	16	X-PCUSHION24	1,020	+51	+102	+152	+203

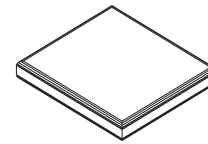

Specify

- Upholstery Selection

Notes

- Credenza and pedestal cushions are a fabric covered 1" thick foam cushion.
- Cushions include Velcro for mounting.

Monitor Arms

SINGLE MONITOR ARM

Model Number	List
A-ERSMASB	805

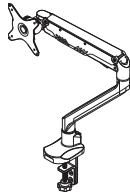

Notes

- Suitable for 10" - 28" size range LCD screens.
- Load capacity of 19lbs per arm.
- Features 180 degree rotation at the mounting base and extension.
- VESA monitor mount for 75mm and 100mm standard.
- Available mounting options include c-clamp, grommet or bolt through.
- Available in silver only.
- Single monitor arm features a snap-in/removable cord clip for wire management.
- Please use the Knife Edge Wedge when attaching monitor arm to knife edge surfaces.
- Select sizes available on quick ship Calibrate Countdown program. See [Calibrate Countdown price list](#) for full details.

DUAL MONITOR ARM

Model Number	List
A-ERDMASB	1,479

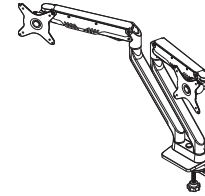

Notes

- Suitable for 10" - 28" size range LCD screens.
- Load capacity of 19lbs per arm.
- Features 180 degree rotation at the mounting base and extension.
- VESA monitor mount for 75mm and 100mm standard.
- Available mounting options include c-clamp, grommet or bolt through.
- Available in silver only.
- Please use the Knife Edge Wedge when attaching monitor arm to knife edge surfaces.
- Select sizes available on quick ship Calibrate Countdown program. See [Calibrate Countdown price list](#) for full details.

DUAL MONITOR ARM FOR SHALLOW DEPTH WORKSURFACES

Model Number	List
A-ERDMAM9	1,479

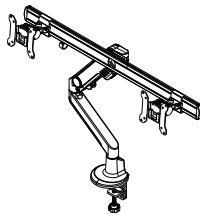

Notes

- Suitable for LCD screens up to 27".
- Load capacity of 14.3 lbs. per monitor.
- Features 180 degree rotation at the mounting base and extension.
- Monitors mount with M4 screws to a VESA bracket.
- VESA monitor mount for 75mm and 100mm standard.
- Mounts with c-clamp on the table edge or through a grommet hole.
- Available in silver only.
- Please use the Knife Edge Wedge when attaching monitor arm to knife edge surfaces.
- Select sizes available on quick ship Calibrate Countdown program. See [Calibrate Countdown price list](#) for full details.

Task Lights

OVERHEAD LED TASK LIGHTS

Length	Model Number	List
24	A-LEDTL-61024	511
40	A-LEDTL-61540	758

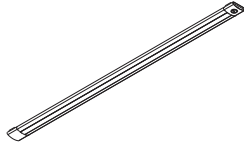

Specify _____ **Notes** _____

- Select sizes available on quick ship Calibrate Countdown program. See [Calibrate Countdown price list](#) for full details.

OVERHEAD LED TASKLIGHT JUMPER CABLE

Model Number	List
A-LEDTL-6-DCW	120



Specify _____ **Notes** _____

- Jumper cables measure 2 feet in length.

LED TASK LIGHT (CLAMP BASE)

Mounting Type	Model Number	List
Clamp	A-DLWL01CC	2,371



Specify _____ **Notes** _____

LED TASK LIGHT (DESK BASE)

Mounting Type	Model Number	List
Desk Base	A-DLWL01DB	2,437



Specify _____ **Notes** _____

LED TASK LIGHT (SHORT ARM CLAMP BASE)

Mounting Type	Model Number	List
Short Arm Clamp	A-DLWL02CC	2,371



Specify _____ **Notes** _____

ASHLEY DUO

Mounting Type	Model Number	List
Clamp	E-ADTCW	1,211
Under	E-ADUMW	1,211

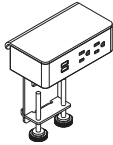

Clamp Mount

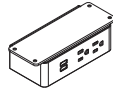

Under Mount

- | Specify | Notes |
|-----------------------------------------------------------------------------------------|-----------------------------------------------------------------------------------------------------------------------------------------------------------------------------------------------------------------------------------------------------------------------------------------------------------------------------------------------------------------------------------------------------------------------------------------------------------------------------------------------------------|
| <ul style="list-style-type: none"> • Color (White/White or White/Silver) | <ul style="list-style-type: none"> • Ashley Duo provides easily accessible power in an impressive and discreet casing. • Two outlets supply reliable power for plugged-in hardware, balanced by a dual 2.1 amp USB port. • Each USB port utilizes a Smart Device Recognition chip to monitor and deliver the required amperage to your devices. • The unit comes with a 72" or 120" cord option and is available with surface, under or bezel mounting options. |

ASHLEY TRIO

Mounting Type	Model Number	List
Clamp	E-ATTCW	1,453
Under	E-ATUMW	1,068

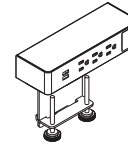

Clamp Mount

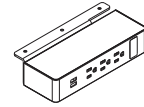

Under Mount

- | Specify | Notes |
|-----------------------------------------------------------------------------------------|----------------------------------------------------------------------------------------------------------------------------------------------------------------------------------------------------------------------------------------------------------------------------------------------------------------------------------------------------------------------------------------------------------------------------------------------------|
| <ul style="list-style-type: none"> • Color (White/White or White/Silver) | <ul style="list-style-type: none"> • Ashley Trio+ features three outlets that deliver AC power for high-power devices, as well as two innovative USB ports. • Each USB port utilizes a Smart Device Recognition Chip to monitor and independently deliver the required amperage for your devices. • The unit comes with a 72" or 120" cord option and is available with surface, under or bezel mounting options. |

CABLE GRIP

Model Number	List
A-CBLGRP	29

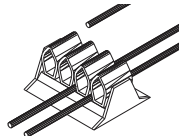
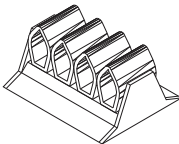

- | Specify | Notes |
|---------|---------------------------------------------------------------------------------------------------------------------------------------------------------------------------------------------------|
| | <ul style="list-style-type: none"> • Installs to surface with four wood screws. • Wires snap into storage position between the loops. • Only available in black. |

CORD MANAGER FOR TAPERED LEG

Model Number	List
RL-WMSL	155

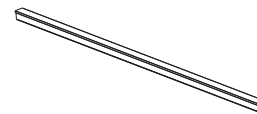

- | Specify | Notes |
|---------|-------|
| | |

U-Channels, Support Brackets and End Panel Risers

U-CHANNEL

Model Number	List
WPS-VC48	129
WPS-VC60	161
WPS-VC72	192

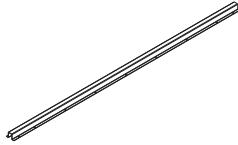

Specify **Notes**

WORKSURFACE SUPPORT BRACKET

Model Number	List
O-WSLB	50

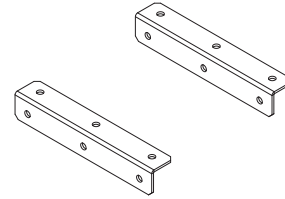

Specify **Notes**

- Model number includes two brackets.
- Brackets measure 5.5" x 1" x 1".
- Available in black only.

PANEL SUPPORT BRACKET

Model Number	List
O-TBBDV10	35



Specify **Notes**

- Can not be used with Matrix.

HUTCH WALL BRACKET

Model Number	List
C-XHWB	62

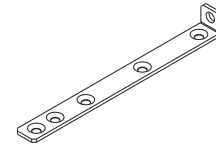

Specify **Notes**

Z-BRACKET

Model Number	List
C-RUNOFFZB	60

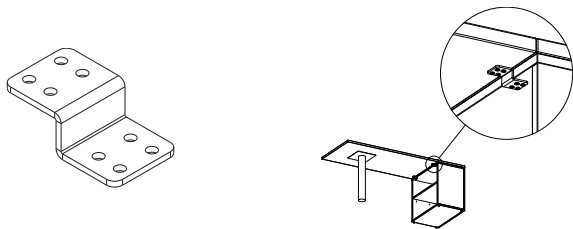

Specify **Notes**

END PANEL RISER

H	W	Model Number	List
7	18	X-RISER0718	313
7	20	X-RISER0720	326
7	24	X-RISER0724	329
7	30	X-RISER0730	334

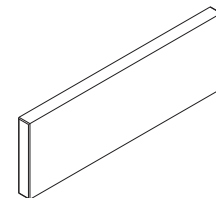

Specify **Notes**

- Laminate Selection
- For use on low non-worksurface height storage to support worksurface.

Task Light Wire Managers for Tackboards

TASK LIGHT WIRE MANAGER FOR WALL MOUNTED TACKBOARDS

For Use With	Model Number	List
20"	X-TTLWM20WM	293
28"	X-TTLWM28WM	326
35"	X-TTLWM35WM	359
37"	X-TTLWM37WM	359



TASK LIGHT WIRE MANAGER FOR HUTCH TACKBOARDS

For Use With	Model Number	List
20"	X-TTLWM20H	289
28"	X-TTLWM28H	320
35"	X-TTLWM35H	353



Notes

- Satin anodized aluminum cover is 1/2" in dimension and can accommodate standard or LED tasklight cords.
- Cover mounts to face of tackboard.

File Bars

FILE BARS FOR DRAWERS

Name	Type	Actual Length	Model Number	List
File Bar A	Side-to-Side	8.39"	RH-WFB10	61
File Bar B	Side-to-Side	14.39"	RH-WFB16	63
File Bar C	Front-to-Back / Side-to-Side	12.125"	RH-WFB12	63
File Bar D	Front-to-Back / Side-to-Side	19.46"	RH-WFB19	67
File Bar E	Side-to-Side	25.77"	RH-WFB26	71
File Bar F	Side-to-Side	31.77"	RH-WFB32	83
File Bar G	Side-to-Side	37.77"	RH-WFB38	89

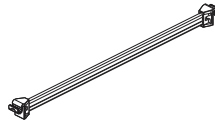

Notes

- See product details pages for more information on correct file bar usage.

Miscellaneous Accessories

FLAT PLATE

Model Number	List
WPS-FP	32

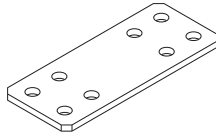

Specify _____ **Notes** _____

FLAT PLATE COVER

Model Number	List
C-FPC	31

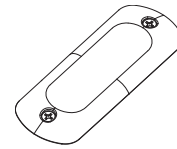

Specify _____ **Notes** _____

- Flat plate cover is used to cover flat plates near worksurface edges to create a protective, smooth finish.

GANGING BOLT

Model Number	List
RH-98002A208	13

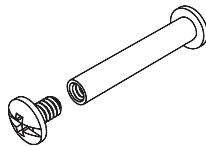

Specify _____ **Notes** _____

WORKSURFACE BAG HOOK

Model Number	List
A-WSPH	286

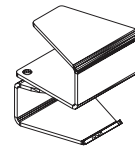

Specify _____ **Notes** _____

- Paint Selection
- Installs without tools by clamping to worksurface.
- Will not work on knife edge surfaces.
- Can hold up to a max weight of 15 pounds.

GROMMET HOLE COVERS

Diameter	Model Number	List
3	W-GROMMET	37

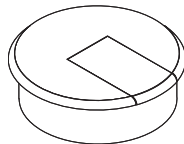

Specify _____ **Notes** _____

- Color Selection - White, Black or Grey Value 1
- Included with worksurfaces ordered with grommets. Order separately only if extra covers are required.
- Require 2 3/4 outside diameter and 2 5/8 inside diameter.
- Available in White, Black or Grey Value 1.

Soft Close Mechanism For Hinged Door

SOFT CLOSE MECHANISM FOR HINGED DOOR

Part Number

List

X-SOFTHINGE

38

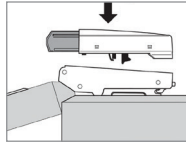
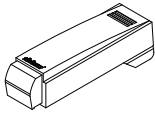

Notes

- Mounting method: snaps on to hinge. No tools required.
- Material: steel
- Color/finish: Nickel-plated
- One required for doors up to 30" tall; doors between 31"H and 66"H – order two; doors over 66"H – order three.
- Compatible only with laminate storage; not compatible with L-Series metal storage.

GANGING KIT FOR CASEGOODS

Part Number

List

X-GANGKIT

15



Notes

- Used for ganging two casegoods together.



National Showrooms:

Leominster

AIS Headquarters
25 Tucker Drive
Leominster, MA 01453

Chicago

The Merchandise Mart
Suite 1086
Chicago, Illinois 60654

New York

AIS New York
257 Park Avenue South
New York, New York 10010

Washington, D.C.

AIS Washington, D.C.
1501 M St, NW, STE 230
Washington, D.C. 20005

GSA Sales

GSA Contract 47QSMA20D08Q4
Multiple Award Schedule (MAS)
Large Category: Furniture & Furnishings
Subcategories: Office Furniture, Packaged
Office Furniture and Furniture Services

For additional information on AIS:

Dealer Showrooms, Representative
Directory, Project Case Studies, Online
Catalog & Product Showcase
Visit: www.ais-inc.com